

MP5M Series

High Performance, Digital Panel Meter

Upgrade

■ Features

- 3 types of operation mode are added.
(total 14 types of operation modes)
Frequency/Revolutions/Speed, Passing speed, Cycle, Passing time, Time interval, Time differential, Absolute ratio, Density, Length measurement 1, Length measurement 2, Interval, Accumulation, Addition/Subtraction-individual input, Addition/Subtraction-phase difference input
- Shorten 32% of rear size than previous MP5M Series
- Various output models:
Relay single(high-limit)/dual(high/low-limit)+ NPN open collector
- Various functions: Selectable NPN solid state/contact input, PNP solid state/contact input, prescale, delay monitoring function, hysteresis, auto-zero time, Lock setting
- Max. display range: -19999 to 99999
- Various display units
rpm, rps, Hz, kHz, sec, min, m, mm, mm/s, m/s, m/min, m/h, l/s, l/min, l/h, %, counts, etc.

Shaded parts(■) are changed and added functions from previous MP5M Series.



⚠ Please read "Caution for your safety" in operation manual before using.



■ Ordering Information

MP	5	M	-	4	N	
Item	Digit	Size		Power supply	Output	
						Main output (Comparative value output)
						N Indicator
						1 Relay single (high-limit) output+NPN open collector output
						2 Relay dual (high/low-limit) output+NPN open collector output
						2 24VAC 50/60Hz, 24-48VDC
						4 100-240VAC 50/60Hz
						M DIN W72×H72mm
						5 99999 (5 Digit)
						MP PULSE METER

■ Specifications

Model	MP5M-2N	MP5M-4N	MP5M-21	MP5M-41	MP5M-22	MP5M-42
Indicator			High-limit setting		High/Low-limit setting	
Display method	7 Segment LED (zero blanking method)					
Character size	W4×H8mm					
Display range	-19999 to 99999					
Power supply	AC voltage	100-240VAC 50/60Hz				
	AC/DC voltage	24VAC 50/60Hz, 24-48VDC				
Power consumption	AC voltage	Max. 9.0VA (100-240VAC 50/60Hz)				
	AC/DC voltage	Max. 6.5VA (24VAC 50/60Hz), Max. 5.0W (24-48VDC)				
Permissible voltage range	90 to 110% of rated voltage					
Power for external sensor	12VDC±10%, 80mA					
Input frequency	·Solid state input: Max. 50kHz (pulse width: Min. 10μs) ·Contact input: Max. 45Hz (pulse width: Min. 11ms)					
Input method	[Voltage Input method] High: 4.5-24VDC, Low: 0-1.0VDC, input impedance: 2.4kΩ [No-voltage Input method] Short-circuit impedance: Max. 80Ω, Residual voltage: Max. 1V, Open-circuit impedance: Min. 100kΩ					
Measurement range	·Mode F1, F2, F7, F8 : 0.0005Hz to 50kHz ·Mode F3, F4, F5, F6 : 0.01 to Max. of each time range ·Mode F9, F10, F11, F14 : 0 to 99999 ·Mode F12, F13 : -19999 to 99999					
Measurement accuracy(23 ±5°C)	·Mode F1, F2, F7, F8: F.S.±0.05% rdg±1 Digit ·Mode F3, F4, F5, F6: F.S.±0.01% rdg±1 Digit					
Display cycle	OFF(for F2, F14 mode), 0.05, 0.5, 1, 2, 4, 8 sec(same as update output cycle)					
Operation mode	Frequency/Revolutions/Speed (F1), Passing speed (F2), Cycle (F3), Passing time (F4), Time interval (F5), Time differential (F6), Absolute ratio (F7), Density (F8), Length measurement 1 (F9), Interval (F10), Accumulation (F11), Addition/Subtraction-individual input (F12), Addition/Subtraction-phase difference input (F13), Length measurement 2 (F14)					

Specifications

Model	MP5M-2N	MP5M-4N	MP5M-21	MP5M-41	MP5M-22	MP5M-42
Prescale function	Indicator		High-limit setting		High/Low-limit setting	
Hysteresis	—		0 to 9999 ^{※1}		—	
Main output	Relay single	—	250VAC 3A resistive load 1c		—	
	Relay dual		—		250VAC 3A resistive load 1a	
	NPN open collector quintuple		Max. 30VDC 100mA			
Memory retention	Non-volatile memory (number of inputs: Min. 100,000 operations)					
Insulation resistance	Min. 100MΩ (at 500VDC megger)					
Dielectric strength	2,000VAC 60Hz for 1 min					
Noise resistance	Square-wave noise by noise simulator (pulse width 1μs) ±2kV					
Vibration	Mechanical	0.75mm amplitude at frequency of 10 to 55Hz in each X, Y, Z direction for 1 hour				
	Malfunction	0.5mm amplitude at frequency of 10 to 55Hz in each X, Y, Z direction for 10 minutes				
Shock	Mechanical	300m/s ² (approx. 30G) in each X, Y, Z direction for 3 times				
	Malfunction	100m/s ² (approx. 30G) in each X, Y, Z direction for 3 times				
Relay life cycle	Mechanical	—		Min. 10,000,000 operations		
	Electrical	—		Min. 100,000 operations (250VAC 3A resistive load)		
Environment	Ambient temp.	-10 to 50°C, storage: -20 to 60°C				
	Ambient humi.	35 to 85%RH, storage: 35 to 85%RH				
Approval	CE c RU _{us}					
Weight ^{※2}	Approx. 243g (approx. 168g)		Approx. 256g (approx. 181g)		Approx. 265g (approx. 190g)	

※1: Setting range will vary depending on the decimal point.

※2: The weight includes packaging. The weight in parentheses is for unit only.

※Environment resistance is rated at no freezing or condensation.

Connections

Indicator (MP5M-□N)

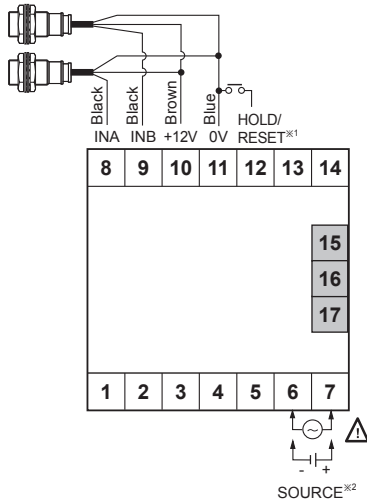

High-limit setting (MP5M-□1)

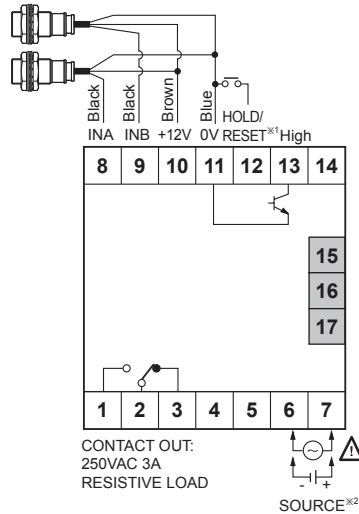

High/Low-limit setting (MP5M-□2)

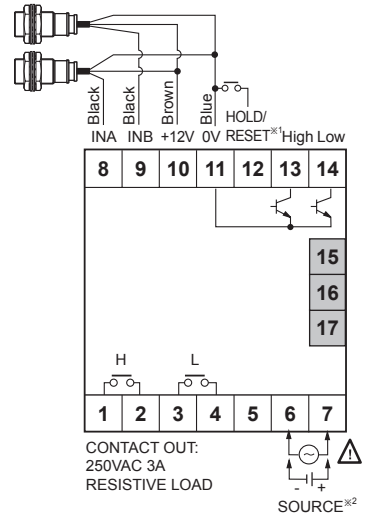

※1: Operation mode F1 to F10:

Display value HOLD

Operation mode F11 to F14:

Display value RESET

※2:

Model	Source
MP5M-21	24VAC 50/60Hz
MP5M-22	24-48VDC
MP5M-2N	
MP5M-41	100-240VAC
MP5M-42	50/60Hz
MP5M-4N	

(A) Photoelectric Sensors

(B) Fiber Optic Sensors

(C) Door/Area Sensors

(D) Proximity Sensors

(E) Pressure Sensors

(F) Rotary Encoders

(G) Connectors/ Connector Cables/ Sensor Distribution Boxes/ Sockets

(H) Temperature Controllers

(I) SSRs / Power Controllers

(J) Counters

(K) Timers

(L) Panel Meters

(M) Tacho / Speed / Pulse Meters

(N) Display Units

(O) Sensor Controllers

(P) Switching Mode Power Supplies

(Q) Stepper Motors & Drivers & Controllers

(R) Graphic/ Logic Panels

(S) Field Network Devices

(T) Software

MP5M Series

■ Dimensions

(unit: mm)

- ※Nameplate design is changed and rear length is shorten than previous MP5M Series.
- ※The high-limit setting model(MP5M-□1) does not include the dotted line parts.

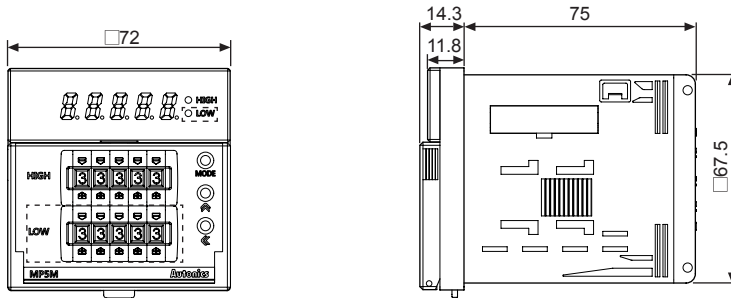

• Panel cut-out dimensions

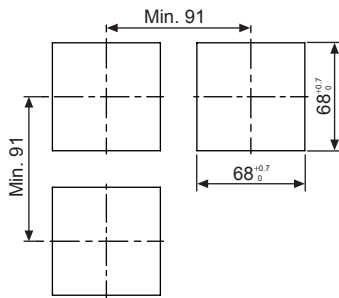

• Bracket

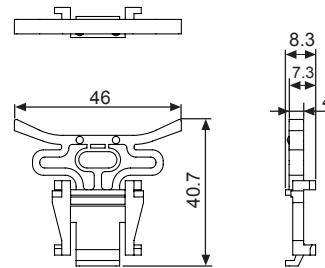

■ Unit Description

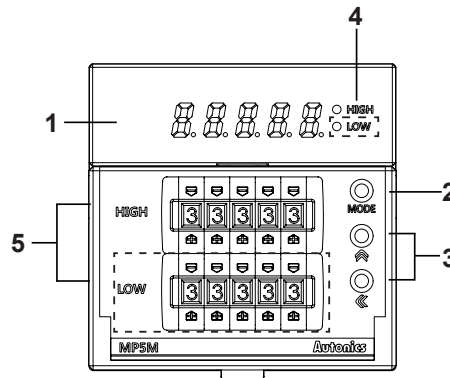

- ※The high-limit setting model(MP5M-□1) does not include the dotted line parts.

1: Display

Displays current value in RUN mode.
Alternately displays setting parameters and corresponding value in SETTING mode.

2: [MODE] key

In RUN mode, press the key once to check max./min. value.
In RUN mode, hold the key for over 2 sec to enter parameter groups.

3: [Left], [Up], [Down], [Right] key

Select parameter groups, and select or setting values in the corresponding parameters.

4: Output status indicator

5: Thumbwheel switch for HIGH/LOW setting value

Input Specifications

1. Input signal

- (1) Solid state input
- ① Input frequency: max. 50kHz
(standard duty ratio of input signal: 1: 1, ON/OFF pulse width: min. 10μs of each)
 - ② Input voltage level: ON voltage → 4.5-24V, OFF voltage → 0-1.0V
- (2) Contact input
- ① Input frequency: max. 45Hz (when each ON/OFF pulse width is over 11ms)
 - ② Contact specifications: 12VDC, stable switching of load current as small as 5mA

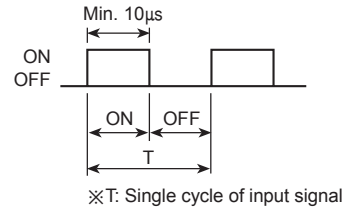

2. Input type [n-R, i n-b]

MP5M allows selection between NPN input (solid state/contact) or PNP input (solid state/contact).

(1) NPN input type

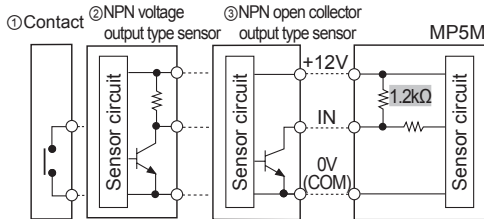

(2) PNP input type

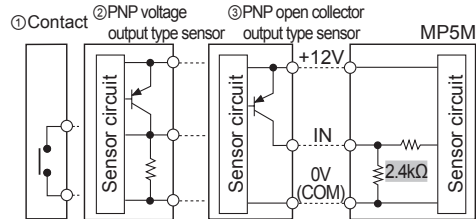

Parameter Groups

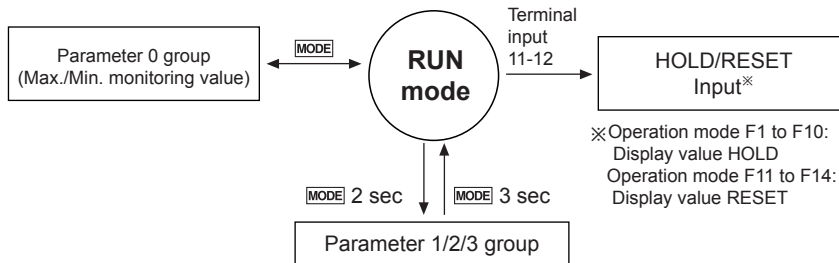

※ Operation mode F1 to F10:
Display value HOLD
Operation mode F11 to F14:
Display value RESET

※ Press the keys to select or set the desired value.

※ Press the **MODE** key once after changing the setting value, to save the setting value and move to the next parameter.

※ Hold the **MODE** key for 1.5 sec at any parameters to return to the select parameter group mode.

※ Hold the **MODE** key for 3 sec to save the setting value and return to RUN mode after changing the setting value.

※ If there is no key input for 60 sec while setting the parameters, the new settings are ignored, and the unit will return to RUN mode with previous settings.

※ The dotted line parameters may not appear depending on output specifications or other parameter settings. Please refer to 'Operation mode by parameter group'.

※ 1: Each parameter and corresponding setting value will flash alternately every 0.5 sec.

Parameter 0 group

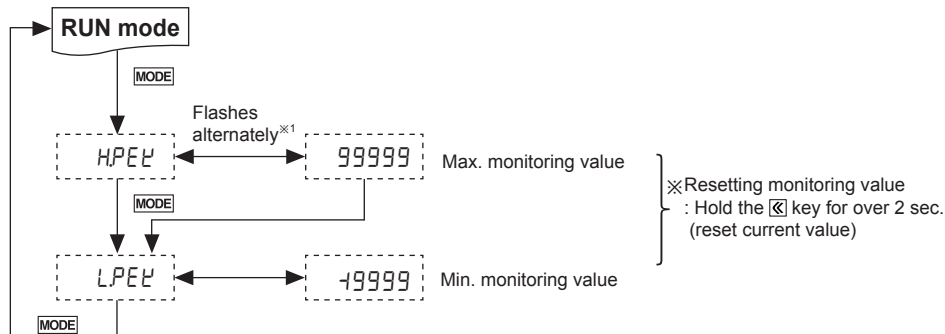

(A) Photoelectric Sensors

(B) Fiber Optic Sensors

(C) Door/Area Sensors

(D) Proximity Sensors

(E) Pressure Sensors

(F) Rotary Encoders

(G) Connectors/ Connector Cables/ Sensor Distribution Boxes/ Sockets

(H) Temperature Controllers

(I) SSRs / Power Controllers

(J) Counters

(K) Timers

(L) Panel Meters

(M) Tacho / Speed / Pulse Meters

(N) Display Units

(O) Sensor Controllers

(P) Switching Mode Power Supplies

(Q) Stepper Motors & Drivers & Controllers

(R) Graphic/ Logic Panels

(S) Field Network Devices

(T) Software

MP5M Series

Parameter 1 group

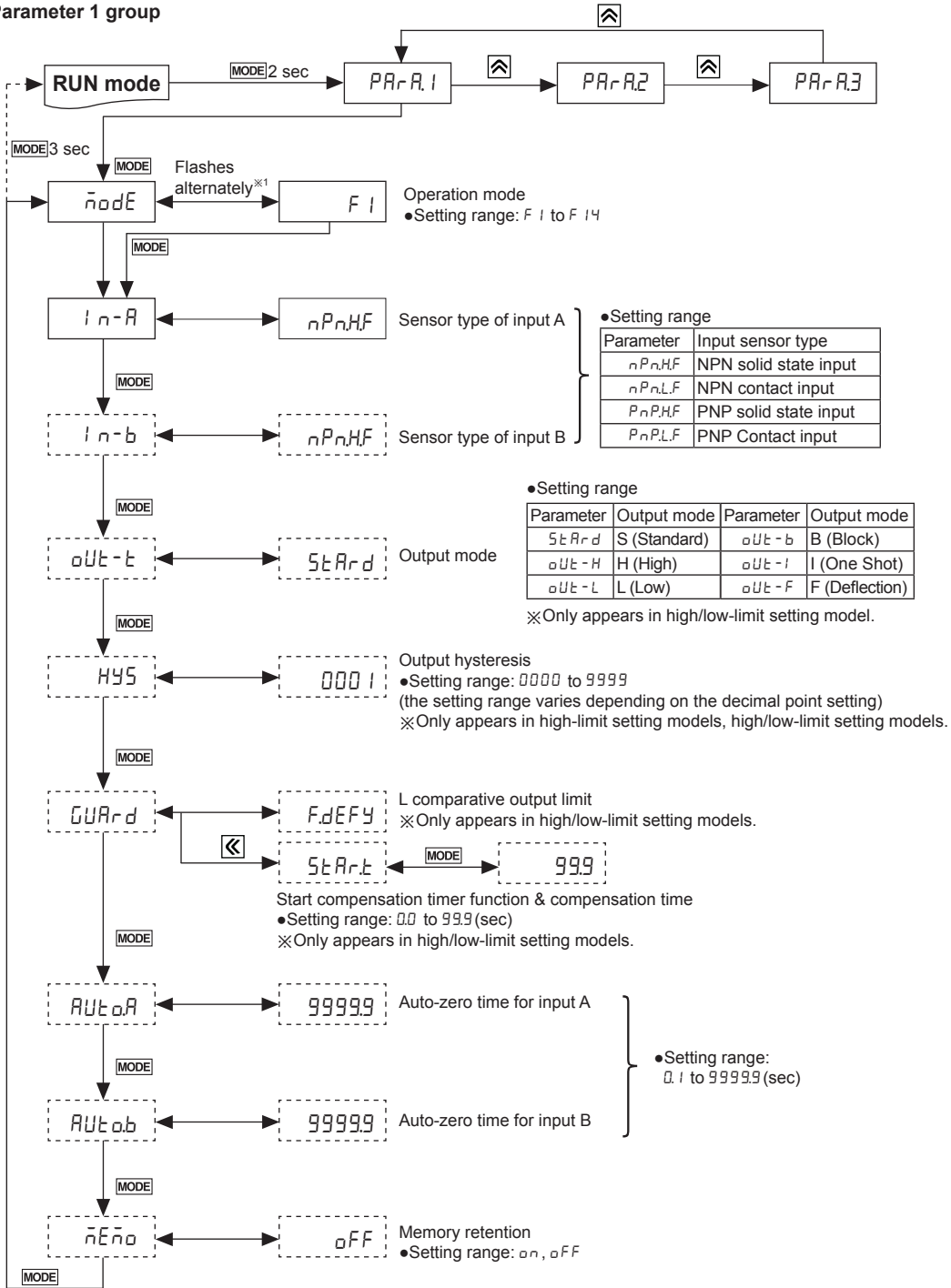

• Parameter 2 group

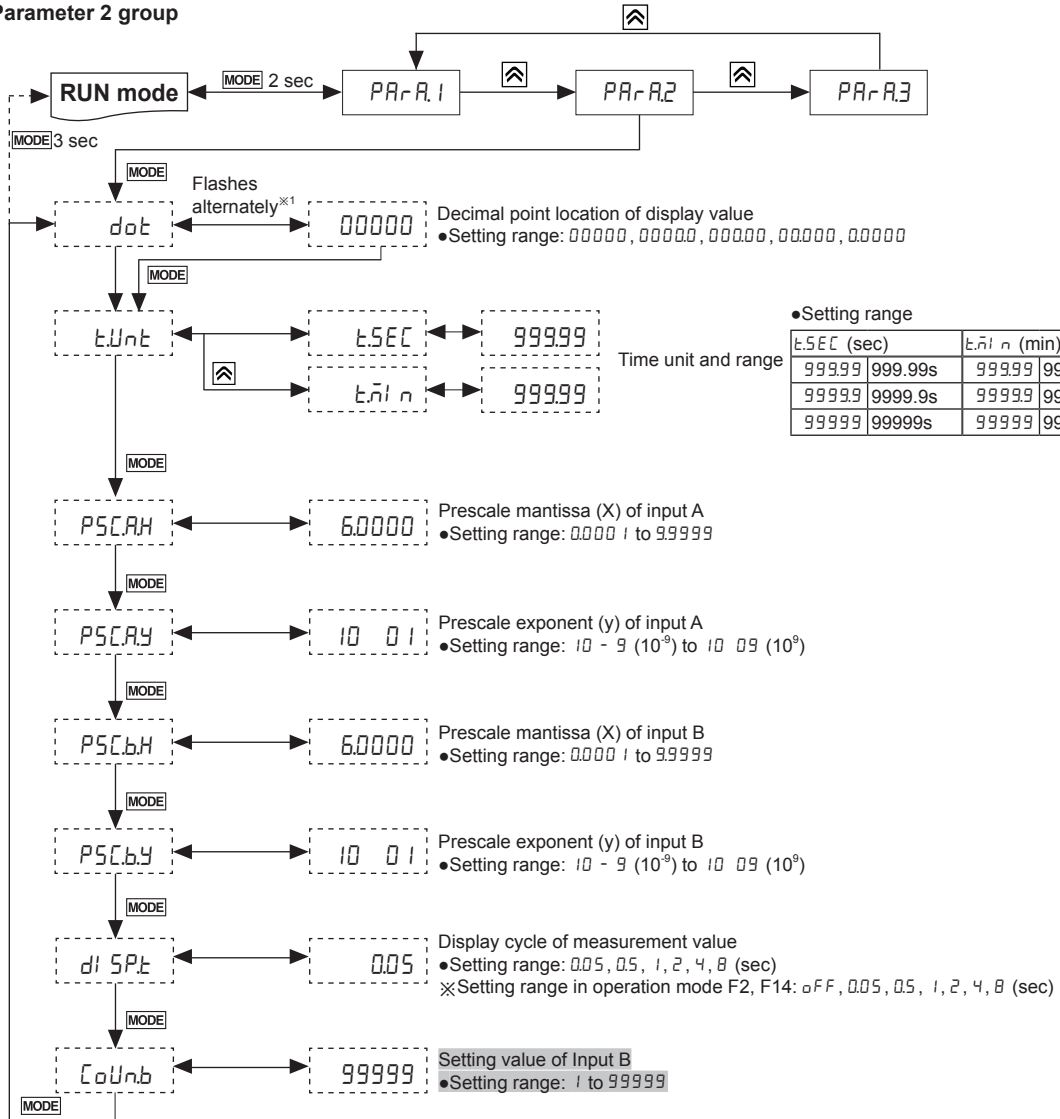

• Parameter 3 group

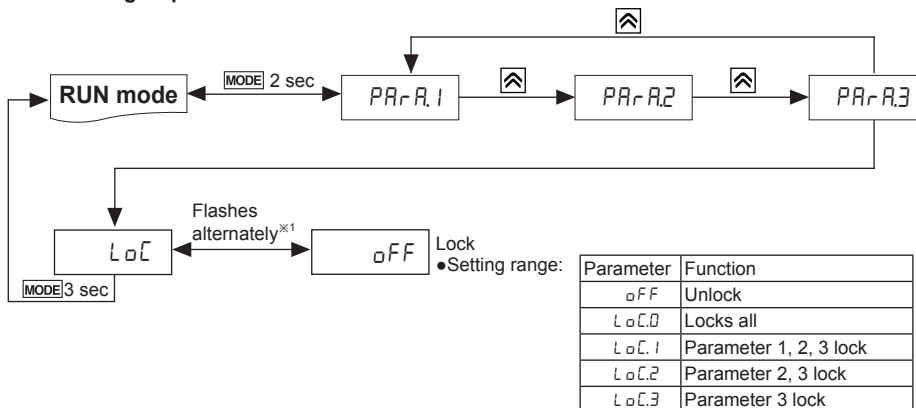

(A) Photoelectric Sensors

(B) Fiber Optic Sensors

(C) Door/Area Sensors

(D) Proximity Sensors

(E) Pressure Sensors

(F) Rotary Encoders

(G) Connectors/ Connector Cables/ Sensor Distribution Boxes/ Sockets

(H) Temperature Controllers

(I) SSRs / Power Controllers

(J) Counters

(K) Timers

(L) Panel Meters

(M) Tacho / Speed / Pulse Meters

(N) Display Units

(O) Sensor Controllers

(P) Switching Mode Power Supplies

(Q) Stepper Motors & Drivers & Controllers

(R) Graphic/ Logic Panels

(S) Field Network Devices

(T) Software

MP5M Series

■ Operation Mode By Parameter Groups

(●: parameter display, X: no parameter display)

Operation mode Parameter	F1	F2	F3	F4	F5	F6	F7	F8	F9	F10	F11	F12	F13	F14	
0	HPEE	●	●	●	●	●	●	●	●	●	X	●	●	X	
	LPEE	●	●	●	●	●	●	●	●	●	X	●	●	X	
1	nodE	Appears in all operation modes(F1 to F14).													
	in-R	Appears in all operation modes(F1 to F14).													
	in-b ^{※1}	X	●	X	X	X	●	●	●	◎ ^{※3}	◎	◎	●	X ^{※4}	● ^{※5}
	out-t ^{※2}	●	●	●	●	●	●	●	●	●	●	X	●	●	●
	HYS ^{※1}	●	X	X	X	X	X	●	●	X	X	X	X	X	X
	Cur-d	●	●	●	●	●	●	●	●	●	●	X	X	X	X
	Aut-aR	●	X	X	●	X	X	●	●	X	X	X	X	X	X
	Aut-aB	X	X	X	X	X	X	●	●	X	X	X	X	X	X
2	dot	●	●	X	X	X	X	●	●	●	●	●	●	●	
	tUnE	X	X	●	●	●	●	X	X	X	X	X	X	X	
	P5C.RH	●	●	X	●	X	X	●	●	●	●	●	●	●	
	P5C.RY	●	●	X	●	X	X	●	●	●	●	●	●	●	
	P5C.bH	X	X	X	X	X	X	●	●	X	X	X	X	X	
	P5C.bY	X	X	X	X	X	X	●	●	X	X	X	X	X	
	dI SPt	●	■ ^{※6}	X	X	X	X	●	●	X	X	X	X	X	■
	CoUn.b	X	X	X	X	X	X	X	X	X	X	X	X	X	●
3	LoC	Appears in all operation modes(F1 to F14).													

※1: Only appears in high/low-limit setting models.

※2: Only appears in high-limit setting models, high/low-limit setting models.

※3: (◎) Only nPnHF or PnPHF setting are available for Input B sensor.

※4: The settings for in-b and in-R are applied.

※5: (●) F output mode[out-F] cannot be set.

※6: (■) setting range: oFF, 0.05, 0.5, 1, 2, 4, 8

● Monitoring delay function by output mode

Output mode	S mode	H mode	L mode	B mode	I mode	F mode
Parameter	StRr-d	out-h	out-L	out-b	out-I	out-F
Comparative output limit	●	X	X	●	X	●
Start compensation timer	●	●	●	●	●	●

MP5M Series

○ F4 Mode: Passing Time

Measures the time from Input A ON to the next ON, and displays the passing time of the arbitrary distance.

$$\text{Passing time[sec]} = t \times \alpha$$

$$\left(\alpha = \frac{L[\text{m}]}{\text{Distance advanced in 1 pulse cycle [m]}} \right)$$

※t: measured time[sec], L: arbitrary distance[m]
 α: prescale value

• Display value and display unit ([t.Unt]) of parameter 2)

Display value	Display unit	
Passing time	Sec	Min
	999.99s(default)	999.99m
	9999.9s	9999.9m
	99999s	99999m

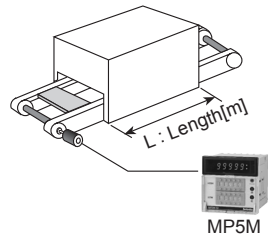

• Timing chart

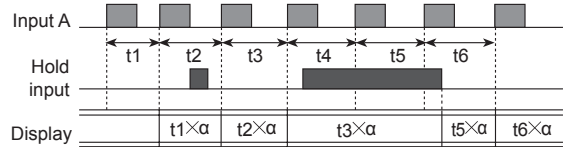

○ F5 Mode: Time Interval

Displays measured time of Input A ON

$$\text{Time interval}(T) = t$$

※t: measured time of input A ON [sec]

• Display value and display unit ([t.Unt]) of parameter 2)

Display value	Display unit	
Time interval	Sec	Min
	999.99s(default)	999.99m
	9999.9s	9999.9m
	99999s	99999m

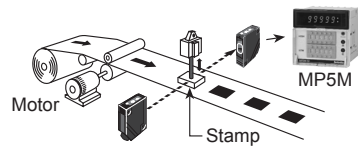

• Timing chart

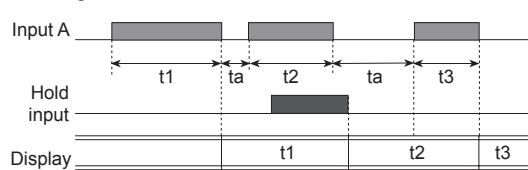

※ta: return time (over 20ms)

○ F6 Mode: Time Differential

Displays measured time from Input A ON to Input B ON.

$$\text{Time differential}(T) = t(\text{ta to tb})$$

※t(ta to tb): measured time from input A ON to input B ON [sec]

• Display value and display unit ([t.Unt]) of parameter 2)

Display value	Display unit	
Time difference	SEC	MIN
	999.99s(default)	999.99m
	9999.9s	9999.9m
	99999s	99999m

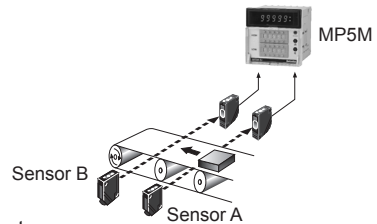

• Timing chart

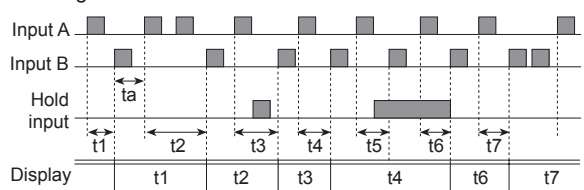

※ta: return time (over 20ms)

Pulse Meter

◎ F7 Mode: Absolute Ratio

Measures and displays relative speed, amount, speed, etc. of input B against input A in percentage (%).

$$\text{Absolute ratio} = (\text{Input B} / \text{Input A}) \times 100\%$$

$$\text{Absolute ratio} = \frac{\text{Frequency of input B [Hz]} \times B\alpha}{\text{Frequency of input A[Hz]} \times A\alpha} \times 100[\%]$$

※Aα: Prescale value of input A, Bα: Prescale value of input B

• Display value and display unit

Display value	Display unit
Absolute ratio	%

※Hold: When the hold signal turns ON, the display value is maintained until the display cycle turns to hold OFF.

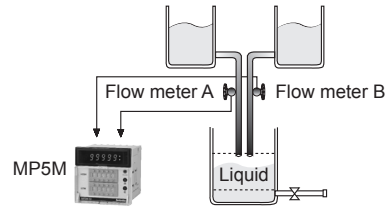

• Timing chart

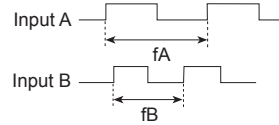

$$\text{Display} = \frac{\text{Frequency of input B[Hz]} \times B\alpha}{\text{Frequency of input A[Hz]} \times A\alpha} \times 100[\%]$$

◎ F8 Mode: Density

Measures and displays the density ratio (%) of input B against the total sum of input A and input B.

$$\text{Density} = \frac{\text{Input B}}{\text{Input A} + \text{Input B}} \times 100[\%]$$

$$\text{Density} = \frac{\text{Frequency of Input B[Hz]} \times B\alpha}{(\text{Frequency of input A[Hz]} \times A\alpha) + (\text{Frequency of input B[Hz]} \times B\alpha)} \times 100[\%]$$

※Aα: Prescale value of input A, Bα: Prescale value of input B

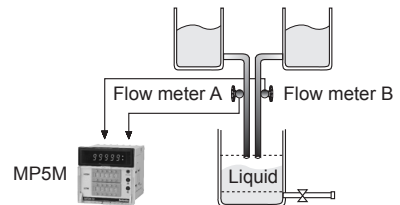

• Timing chart

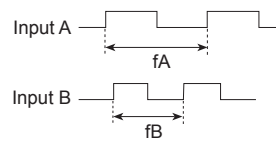

• Display value and display unit

Display value	Display unit
Density	%

※Hold: When the hold signal turns ON, the display value is maintained until the display cycle turns to hold OFF.

◎ F9 Mode: Length Measurement 1

Measure and display the number of input A pulses during input B ON.

$$\text{Length measurement} = P \times \alpha$$

※P: Number of input A pulses, α: Prescale value

• Display value and display unit

Display value	Display unit
Length measurement	Quantity(default)
	mm
	cm
	m

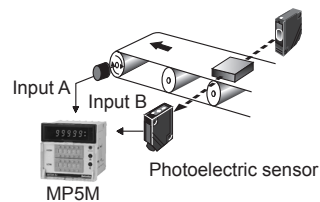

• Timing chart

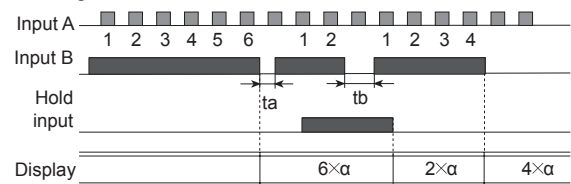

※ta, tb: return time(over 20ms)

(A) Photoelectric Sensors

(B) Fiber Optic Sensors

(C) Door/Area Sensors

(D) Proximity Sensors

(E) Pressure Sensors

(F) Rotary Encoders

(G) Connectors/ Connector Cables/ Sensor Distribution Boxes/ Sockets

(H) Temperature Controllers

(I) SSRs / Power Controllers

(J) Counters

(K) Timers

(L) Panel Meters

(M) Tacho / Speed / Pulse Meters

(N) Display Units

(O) Sensor Controllers

(P) Switching Mode Power Supplies

(Q) Stepper Motors & Drivers & Controllers

(R) Graphic/ Logic Panels

(S) Field Network Devices

(T) Software

MP5M Series

○ F10 Mode: Interval

Measures and displays the number of input A pulses from Input B ON to the next ON.

$$\text{Interval} = P \times \alpha$$

※P: Number of input A pulses, α : Prescale value

• Display value and display unit

Display value	Display unit
Interval	Quantity(default)
	mm
	cm
	m

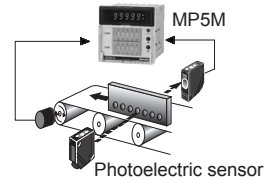

• Timing chart

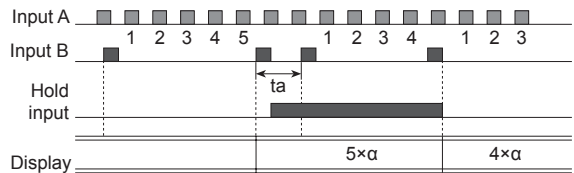

※ta: return time (over 20ms)

○ F11 Mode: Accumulation

Measures and displays the counted value of input A pulses.

$$\text{Accumulation} = P \times \alpha$$

※P: Number of input A pulses, α : Prescale value

• Display value and display unit

Display value	Display unit
Accumulation	Quantity[EA]

• Operation

- ① Counts the number of input A pulses.
- ② Input B is an enable input signal. During ON, the quantity and display value of input A will be held, and during OFF input A will be re-counted.
- ③ When RESET input is ON, the integrated counted value will be reset to "0".

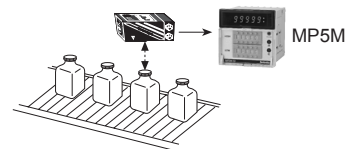

• Timing chart

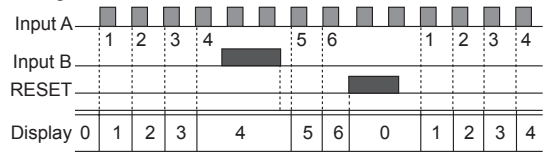

※ $\alpha=1$ display value

○ F12 Mode: Addition/Subtraction-Individual Input

Displays the counted value from added input A pulses and subtracted input B pulses. When there are two inputs simultaneously, it will not count.

$$\text{Addition/Subtraction} = \text{Input A} \times \alpha - \text{Input B} \times \beta$$

※ α : Prescale value of input A, β : Prescale value of input B

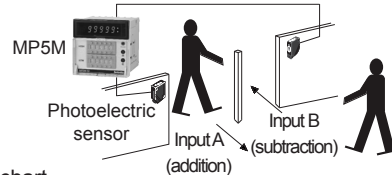

• Timing chart

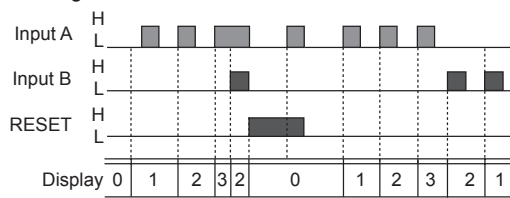

※ $\alpha, \beta=1$ display value

• Display value and display unit

Display value	Display unit
Addition/ Subtraction (individual input)	Quantity

• Operation and timing chart

Pulse of input A is added, and pulse of input B is subtracted.

○ F13 Mode: Addition/Subtraction- Phase difference input

When input A is low, counting is added to the low of input B.
When input A is low, counting is subtracted from the high of input B.

Addition/Subtraction(phase difference)

= Detects position and speed using A and B phases of encoder outputs as input.

• Display value and display unit

Display value	Display unit
Up/Down counting (phase difference input)	Quantity

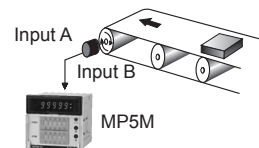

• Timing chart

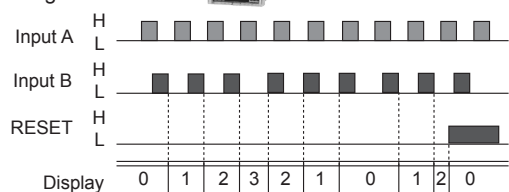

○ F14 Mode: Length Measurement 2

Measures and displays the number of pulses from input A until the value of input B reaches the set value.

Length measurement 2 = $P \times \alpha$ (until the setting value of Input B)

※P: Number of input A pulses, α : Prescale value

• Display value and display unit

Display value	Display unit
Length measurement 2	Quantity[EA]

※If input A and input B are ON during initial power supply, it will not count and only count the number of rising edge.

※Display value is renewed depending on the display cycle [d_i 5P.t] setting.

• Timing chart (e.g.) setting value of Input B=4

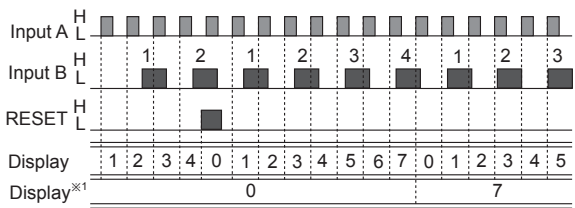

※1: When the display cycle [d_i 5P.t] setting is OFF, it will maintain the quantity of input A until the value of input B reaches the setting value B[$\alpha \alpha n b$].

■ Output Modes [OUT - t]

- MP5M-□1: S output mode, MP5M-□2: S, B, H, L, I, F output mode
- Requirement for setting comparative value: (B output mode) $L < H$, (F output mode) $L < H$, (other output modes) individual output operation regardless of size or order of set comparative values.

○ S(Standard)[5t Arr d]

B(Block)[OUT - b] Output Mode

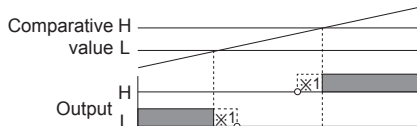

H output : Comparative value $H \leq$ Display value
L output : Comparative value $L \geq$ Display value

○ I(One Shot) Output Mode[OUT - l]

※No hysteresis for I output mode

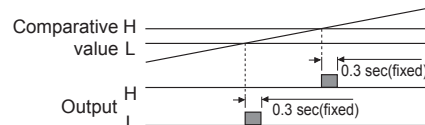

H output : Comparative value $H \leq$ Display value
L output : Comparative value $L \leq$ Display value

※1: hysteresis

○ H(High) Output Mode[OUT - H]

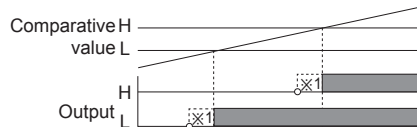

H output : Comparative value $H \leq$ Display value
L output : Comparative value $L \leq$ Display value

○ L(Low) Output Mode[OUT - L]

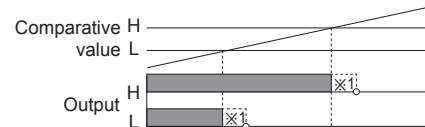

H output : Comparative value $H \geq$ Display value
L output : Comparative value $L \geq$ Display value

○ F(Deflection) Output Mode[OUT - F]

Transmits outputs when the saved setting value exceeds H deviation or L deviation.

- Saving setting value: Press the [MODE]+[SAVE] keys to save as setting value.
- Checking setting value: Press the [CHECK] key to check the setting value.
- Setting deviation: Based on the setting value, set H deviation, L deviation by the thumbwheel switches. (the set deviation value is saved during Power OFF until it is re-set.)
- Deviation setting range: 0.0001 to 99999(setting range depends on the decimal point [$d_{\alpha t}$] setting.)
E.g.)Decimal point [$d_{\alpha t}$]: "0000.0", Setting range: 0.1 to 9999.9

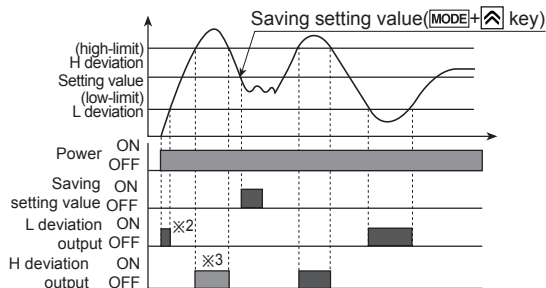

※2: When selecting initial comparative output limit function, it does not transmit outputs.

※3: The graph is assuming that there is a saved setting value prior to the setting value save point. The actual output position may be different.

※The deviation can be set to "0" but the actual operation will be the same as "1".

(A) Photoelectric Sensors
(B) Fiber Optic Sensors
(C) Door/Area Sensors
(D) Proximity Sensors
(E) Pressure Sensors
(F) Rotary Encoders
(G) Connectors/ Connector Cables/ Sensor Distribution Boxes/ Sockets
(H) Temperature Controllers
(I) SSRs / Power Controllers
(J) Counters
(K) Timers
(L) Panel Meters
(M) Tacho / Speed / Pulse Meters
(N) Display Units
(O) Sensor Controllers
(P) Switching Mode Power Supplies
(Q) Stepper Motors & Drivers & Controllers
(R) Graphic/ Logic Panels
(S) Field Network Devices
(T) Software

MP5M Series

Function

◎ Hysteresis [HY5]

The output may turn ON/OFF frequently near the comparative setting value. To prevent this, set the hysteresis value with the comparative setting value as reference.

※A: hysteresis value

※The hysteresis value can be set to "0" but the actual operation value will be at "1".

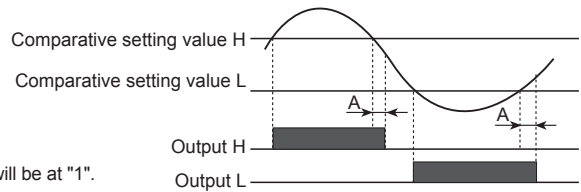

◎ Delay Monitoring [GUR.d]

After supplying power, the starting current of motors and other inputs may experience changes. This function allows stable control by limiting all outputs for a certain period until the target measurement unit stabilizes. It may also control L outputs until a specific output is reached.

• Comparative output limit function [F.dFF4]

: Only for S(Standard), B(Block), F(Deflection) output mode.

: Limits L output before H output.

1) During S(Standard), B(Block) output mode

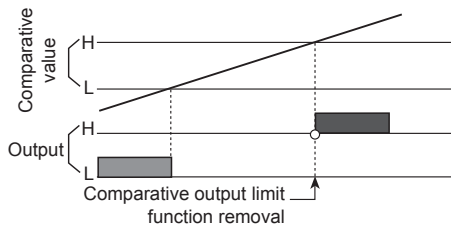

※After supplying power, there is no initial L comparative output (■).

※Each setting value of H, L is not related to their relative sizes.

Hence, H value may be lower or equal to L value.

2) During F(Deflection) output mode

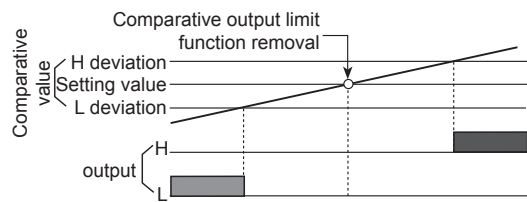

※After supplying power, there is no comparative output of L deviation (■).

※H and L deviation are not related to their relative sizes.

(H deviation setting value > L deviation setting value,
H deviation setting value < L deviation setting value)

• Start compensation timer function [5tArr.t]

Set monitoring delay time so that there is no output during the delay time.

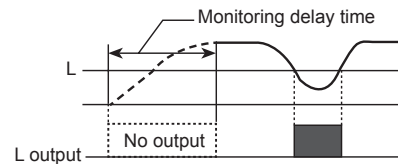

◎ Auto-Zero Time Setting [Aut.aR, Aut.a.b]

When there is no input signal during auto-zero set time, the display value is automatically set to 0(zero). Please set the auto-zero set time so that it is longer than the interval of the slowest input signal. If the setting time is too long and there is no input signal, the rate at which the display value falls to 0(zero) decrease, and output response rate may slow down.

◎ Prescale [P5C.aH, P5C.a.Y]

Displays values in required units or specific multiples by counting the number of input pulses, then multiplying the number of pulses or the length of pulses by variables (X×10^Y).

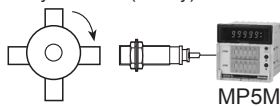

$$\begin{aligned} \text{Number of revolutions (rpm)} &= f \times \alpha \\ &= f \times 60 \times (1 / N) \\ &= f \times 60 \times (1 / 4) \\ &= f \times 60 \times 0.25 \\ &= f \times 15 \end{aligned}$$

• Setting prescale value (α=15)

Set mantissa (X) as 1.5000, and exponent (Y) as 1 for prescale value (α)=15.

The same display value can be obtained with α value set as X=0.1500, and Y=2.

※f: The number of input pulses per second [Hz],

α: Prescale value

N: The number of pulses per revolution

Cautions During Use

- Please separate the unit wiring from high voltage lines or power lines to prevent inductive noise.
- Install a power switch or circuit breaker to control the power supply.
- The power switch or circuit breaker should be installed where it is easily accessible by the user.
- Do not use the unit in the following environments.
 - ① Environments with high vibration or shock.
 - ② Environments with exposure to direct sunlight.
 - ③ Near machinery which produce strong magnetic force or electric noise.

• Storing the unit

When storing the unit for an extended period, please avoid direct exposure to sunlight. Ambient temperature should be between -20°C to 60°C and ambient humidity should be between 35% to 85%RH. Store in factory packaging for best results.

• Input line

Please use a shield wire in environments where noise may occur or instances where long measurement input lines are required.

• Please maintain distance between the power supply line and measurement input line.

• This product may be used in the following environments

- ① Indoors
- ② Max. altitude: 2,000m
- ③ Pollution degree 2
- ④ Installation category II