

USER'S MANUAL

FRENIC-HVAC Series

FRENIC-HVAC

User's Manual

Copyright © 2012-2016 Fuji Electric Corp. of America

All rights reserved.

No part of this publication may be reproduced or copied without prior written permission from Fuji Electric Corp. of America.

All products and company names mentioned in this manual are trademarks or registered trademarks of their respective holders.

The information contained herein is subject to change without prior notice for improvement.

Preface

This manual provides all the information on the FRENIC-HVAC series of inverters including its operating procedure, operation modes, and selection of peripheral equipment. Carefully read this manual for proper use. Incorrect handling of the inverter may prevent the inverter and/or related equipment from operating correctly, shorten their lives, or cause problems.

The table below lists the other materials related to the use of the FRENIC-HVAC. Read them in conjunction with this manual as necessary.

Name	Material No.	Description
Catalog	24A1-E-0068	Product scope, features, specifications, external drawings, and options of the product
Instruction Manual	INR-SI47-1707-JE	Acceptance inspection, mounting & wiring of the inverter, operation using the keypad, running the motor for a test, troubleshooting, and maintenance and inspection
RS-485 Communication User's Manual	24A7-E-0021	Overview of functions implemented by using FRENIC-HVAC RS-485 communications facility, its communications specifications, Modbus RTU/Fuji general-purpose inverter protocol and functions, and related data formats

The materials are subject to change without notice. Be sure to obtain the latest editions for use.

The latest editions can be downloaded from our Web side at:

<http://www.americas.fujielectric.com/components/drives-inverters>

Safety precautions

Read this manual and the FRENIC-HVAC Instruction Manual (that comes with the product) thoroughly before proceeding with installation, connections (wiring), operation, or maintenance and inspection. Ensure you have sound knowledge of the product and familiarize yourself with all safety information and precautions before proceeding to operate the inverter.

Safety precautions are classified into the following two categories in this manual.

⚠ WARNING	Failure to heed the information indicated by this symbol may lead to dangerous conditions, possibly resulting in death or serious bodily injuries.
⚠ CAUTION	Failure to heed the information indicated by this symbol may lead to dangerous conditions, possibly resulting in minor or light bodily injuries and/or substantial property damage.

Failure to heed the information contained under the CAUTION title can also result in serious consequences. These safety precautions are of utmost importance and must be observed at all times.

⚠ CAUTION
This product is not designed for use in appliances and machinery on which lives depend. Consult your Fuji Electric representative before considering the FRENIC-HVAC series of inverters for equipment and machinery related to nuclear power control, aerospace uses, medical uses or transportation. When the product is to be used with any machinery or equipment on which lives depend or with machinery or equipment which could cause serious loss or damage should this product malfunction or fail, ensure that appropriate safety devices and/or equipment are installed.

How this manual is organized

This manual contains Chapters 1 through 11 and Appendices.

Chapter 1 ABOUT FRENIC-HVAC

This chapter describes the features and control system of the FRENIC-HVAC series and the recommended configuration for the inverter and peripheral equipment.

Chapter 2 SPECIFICATIONS

This chapter describes specifications of the output ratings, control system, and terminal functions for the FRENIC-HVAC series of inverters. It also provides descriptions of the operating and storage environment, product warranty, precautions for use, external dimensions, examples of basic connection diagrams, and details of the protective functions.

Chapter 3 SELECTING OPTIMAL MOTOR AND INVERTER CAPACITIES

This chapter provides you with information about the inverter output torque characteristics, selection procedure, and equations for calculating capacities to help you select optimal motor and inverter models.

Chapter 4 SELECTING PERIPHERAL EQUIPMENT

This chapter describes how to use a range of peripheral equipment and options, FRENIC-HVAC's configuration with them, and requirements and precautions for selecting wires and crimp terminals.

Chapter 5 PREPARATION AND TEST RUN

This chapter details the operating environment, storage environment, installation, wiring, basic connection examples, names and functions of the keypad components, operation using the keypad, and test run procedure.

Chapter 6 FUNCTION CODES

This chapter contains overview tables of 12 groups of function codes available for the FRENIC-HVAC series of inverters, function code index by purpose, and details of function codes.

Chapter 7 BLOCK DIAGRAMS FOR CONTROL LOGIC

This chapter provides the main block diagrams for the control logic of the FRENIC-HVAC series of inverters.

Chapter 8 RUNNING THROUGH RS-485 COMMUNICATION

This chapter describes an overview of inverter operation through the RS-485 communications facility. Refer to the RS-485 Communication User's Manual for details.

Chapter 9 TROUBLESHOOTING

This chapter describes troubleshooting procedures to be followed when the inverter malfunctions or detects an alarm or a light alarm condition. In this chapter, first check whether any alarm code or the "light alarm" indication (L-AL) is displayed or not, and then proceed to the troubleshooting items.

Chapter 10 MAINTENANCE AND INSPECTION

This chapter provides the instructions on how to perform daily and periodic inspections in order to avoid trouble and keep reliable operation of the inverter for a long time.

Chapter 11 CONFORMITY WITH STANDARDS

This chapter sets forth the conformity with overseas standards.

Appendices

Icons

The following icons are used throughout this manual.



This icon indicates information which, if not heeded, can result in the inverter not operating to full efficiency, as well as information concerning incorrect operations and settings which can result in accidents.



This icon indicates information that can prove handy when performing certain settings or operations.



This icon indicates a reference to more detailed information.

CONTENTS

Chapter 1 About FRENIC-HVAC

1.1 Features.....	1-1
1.2 Inspection of goods and product appearance.....	1-13
1.2.1 Inspection of goods.....	1-13
1.2.2 Product appearance.....	1-15

Chapter 2 SPECIFICATIONS

2.1 Standard Model FRENIC-HVAC.....	2-1
2.1.1 Three-phase 230 V class series (USA models).....	2-1
2.1.2 Three-phase 460 V class series (USA models).....	2-3
2.1.3 Three-phase 575 V class series (USA models).....	2-6
2.2 Common Specifications.....	2-9
2.3 Terminal Specifications.....	2-16
2.3.1 Terminal functions.....	2-16
2.3.2 Setting up the slide switches.....	2-26
2.3.3 Screw specifications and recommended wire sizes.....	2-28
2.3.3.1 Main circuit terminals.....	2-28
2.3.3.2 Control circuit terminals (Common to all inverter types).....	2-35
2.4 Conduits.....	2-36
2.4.1 Conduits.....	2-36
2.5 Leakage Current of the EMC Filter.....	2-39
2.6 Derating of Rated Output Current.....	2-42
2.7 Operating Environment and Storage Environment.....	2-44
2.7.1 Operating environment.....	2-44
2.7.2 Storage environment.....	2-45
2.7.2.1 Temporary storage.....	2-45
2.7.2.2 Long-term storage.....	2-45
2.8 Precautions for Using Inverters.....	2-46
2.8.1 Precautions in introducing inverters.....	2-46
2.8.2 Precautions in running inverters.....	2-50
2.8.3 Precautions in using special motors.....	2-50
2.9 External Dimensions.....	2-51
2.9.1 Standard models.....	2-51
2.9.2 Keypad.....	2-64
2.10 Connection Diagrams.....	2-65

Chapter 3 SELECTING OPTIMAL MOTOR AND INVERTER CAPACITIES

3.1 Selecting Motors and Inverters.....	3-1
3.1.1 Motor output torque characteristics.....	3-1
3.1.2 Selection procedure.....	3-3
3.1.3 Equations for selections.....	3-6
3.1.3.1 Load torque during constant speed running.....	3-6
3.1.3.2 Calculation of acceleration/deceleration time.....	3-7
3.1.3.3 Heat energy calculation of braking resistor.....	3-10

Chapter 4 SELECTING Peripheral EQUIPMENT

4.1 Configuring the FRENIC-HVAC.....	4-1
4.2 Currents flowing across the inverter terminals.....	4-2
4.3 Peripheral Equipment.....	4-5

4.3.1	Molded case circuit breaker (MCCB), residual-current-operated protective device (RCD)/ earth leakage circuit breaker (ELCB) and magnetic contactor (MC)	4-5
4.3.2	Surge killers for L-load	4-10
4.3.3	Arresters	4-11
4.3.4	Surge absorbers	4-12
4.4	Options	4-13
4.4.1	Selecting peripheral equipment options	4-13
4.4.1.1	Power regenerative PWM converters, RHC series	4-13
4.4.1.2	AC reactors (ACRs)	4-36
4.4.1.3	DC reactors (DCRs) (Built-in or bundled as standard)	4-41
4.4.1.4	Surge suppression unit (SSU)	4-43
4.4.1.5	Output circuit filters (OFLs)	4-44
4.4.1.6	Zero-phase reactors for reducing radio noise (ACLs)	4-48
4.4.2	Selecting options for operation and communication	4-49
4.4.2.1	External frequency command potentiometer	4-49
4.4.2.2	Extension cable for remote operation	4-50
4.4.2.3	Frequency meters	4-50
4.4.2.4	Inverter support loader software	4-51
4.4.3	Selecting Option Cards	4-52
4.4.3.1	List of option cards, connection ports, and applicable ROM versions	4-52
4.4.3.2	Relay output interface card (OPC-RY)	4-53
4.4.3.3	Relay output interface card (OPC-RY2)	4-55
4.4.3.4	Analog interface card (OPC-AIO)	4-57
4.4.3.5	Analog current output (2 ch) interface card (OPC-AO)	4-61
4.4.3.6	Resistance temperature detector input card (OPC-PT)	4-63
4.4.3.7	CC-Link communications card (OPC-CCL)	4-66
4.4.3.8	PROFIBUS-DP communications card (OPC-PDP2)	4-68
4.4.3.9	DeviceNet communications card (OPC-DEV)	4-71
4.4.3.10	CANopen communications card (OPC-COP)	4-74
4.4.3.11	LONWORKS communications card (OPC-LNW)	4-76
4.4.3.12	Ethernet communications card (OPC-ETH)	4-77
4.5	Backup Battery	4-79
4.5.1	Outline	4-79
4.5.2	Loading the battery	4-80
4.5.3	Battery replacement procedure	4-82
4.5.4	About air transport of batteries	4-82

Chapter 5 PREPARATION AND TEST RUN

5.1	Mounting and Wiring the Inverter	5-1
5.1.1	Installing the inverter	5-1
5.1.2	Wiring	5-4
5.1.2.1	Removing and mounting the front cover and the wiring plate	5-4
5.1.2.2	Input ferrite core diameter	5-7
5.1.3	Screw specifications and recommended wire sizes	5-7
5.1.3.1	Main circuit terminals	5-7
5.1.3.2	Control circuit terminals (Common to all inverter types)	5-7
5.1.4	Conduits	5-7
5.1.5	Wiring precautions	5-8
5.1.6	Wiring of main circuit terminals and grounding terminals	5-9
5.1.7	Wiring for control circuit terminals	5-16
5.1.8	Setting up the slide switches	5-19
5.1.9	USB port	5-20

5.2	Mounting and Connecting a Keypad.....	5-21
5.2.1	Parts required for connection	5-21
5.2.2	Mounting procedure.....	5-21
5.3	Operation Using the Keypad.....	5-24
5.3.1	LCD monitor, keys and LED indicators on the keypad.....	5-24
5.4	Overview of Operation Modes.....	5-28
5.5	Running Mode	5-29
5.5.1	Monitoring the running status	5-29
5.5.2	Setting up frequency and PID commands	5-32
5.5.3	Running/stopping the motor.....	5-36
5.5.4	Remote and local modes	5-36
5.5.5	Changing from keypad operation to external signal (terminal block) operation.....	5-37
5.5.6	Monitoring light alarms.....	5-37
5.6	Programming Mode	5-38
5.6.1	Quick Setup.....	5-40
5.6.2	Start-up.....	5-40
5.6.2.1	Set Display Language.....	5-41
5.6.2.2	Function-Specific Initialization	5-42
5.6.2.3	Date/Time Settings.....	5-42
5.6.2.4	Set Display	5-45
5.6.3	Function Codes	5-46
5.6.3.1	Setting up function codes	5-47
5.6.3.2	Confirm Data.....	5-49
5.6.3.3	Confirm Changed Function Code.....	5-49
5.6.3.4	Copying data	5-49
5.6.3.5	Set Timer Operation	5-61
5.6.3.6	Initialize Data.....	5-64
5.6.4	Inverter Information.....	5-65
5.6.4.1	Confirm Power Level.....	5-65
5.6.4.2	Confirm Operational Status.....	5-66
5.6.4.3	Check Status of Input/Output Signal.....	5-69
5.6.4.4	View Maintenance Information.....	5-71
5.6.4.5	View Unit Information	5-75
5.6.5	Alarm Information	5-76
5.6.5.1	Confirm Alarm History	5-76
5.6.5.2	Confirm Light Alarm History.....	5-80
5.6.5.3	Retry History.....	5-80
5.6.6	User Config.....	5-81
5.6.6.1	Quick Setup.....	5-81
5.6.6.2	Password	5-81
5.6.7	Tools.....	5-85
5.6.7.1	Monitor PID Control Status	5-85
5.6.7.2	Monitor Multiple Unit Controls	5-88
5.6.7.3	Monitor Customized Logic (CLogic).....	5-91
5.6.7.4	Resonance Avoidance.....	5-92
5.6.7.5	Load Factor Measurement.....	5-93
5.6.7.6	Communication Debug	5-96
5.7	Alarm Mode.....	5-97
5.7.1	Releasing the alarm and switching to Running mode	5-97
5.7.2	Displaying the alarm history	5-97
5.7.3	Displaying the status of inverter at the time of alarm	5-97
5.7.4	Test run procedure.....	5-98

5.7.5	Checking prior to powering ON.....	5-99
5.7.6	Powering ON and checking.....	5-100
5.7.7	Selecting a desired motor drive control.....	5-100
5.7.8	Function code basic settings < 1 >	5-101
5.7.9	Function code basic settings and tuning < 2 >	5-103
5.7.10	Running the inverter for motor operation check	5-106
5.7.11	Preparation for practical operation	5-107

Chapter 6 FUNCTION CODES

6.1	Overview of Function Codes	6-1
6.2	Function Code Tables.....	6-2
6.3	Details of Function Codes.....	6-41
6.3.1	F codes (Fundamental functions)	6-41
6.3.2	E codes (Extension terminal functions).....	6-84
6.3.3	C codes (Control functions)	6-125
6.3.4	P codes (Motor 1 parameters)	6-137
6.3.5	H codes (High performance functions)	6-141
6.3.6	H1 codes (High performance functions)	6-174
6.3.7	J codes (Application functions 1).....	6-181
6.3.8	J1 codes (PID control 1).....	6-182
6.3.9	J2 codes (PID control 2).....	6-215
6.3.10	J5 codes (External PID control 1)	6-217
6.3.11	J6 codes (External PID control 2, 3)	6-245
6.3.12	d codes (Application functions 2)	6-249
6.3.13	U codes (Customizable logic functions)	6-249
6.3.14	U1 codes (Customizable logic functions)	6-270
6.3.15	y codes (Link functions).....	6-275
6.3.16	T codes (Timer functions)	6-280
6.3.17	K codes (Keypad functions).....	6-284

Chapter 7 BLOCK DIAGRAMS FOR CONTROL LOGIC

7.1	Symbols Used in Block Diagrams and their Meanings.....	7-1
7.2	Frequency Command Block.....	7-2
7.3	Drive Command Block	7-4
7.4	V/f Control Block	7-5
7.5	PID Process Control Block	7-7
7.6	External PID Process Control Block.....	7-9
7.7	FM1/FM2 Output Selector.....	7-11

Chapter 8 RUNNING THROUGH RS-485 COMMUNICATION

8.1	Overview on RS-485 Communication	8-1
8.1.1	RS-485 common specifications.....	8-2
8.1.2	Terminal specifications for RS-485 communication	8-3
8.1.3	Connection method	8-4
8.1.4	Communications support devices.....	8-6
8.1.5	Noise suppression	8-7
8.2	Overview of FRENIC Loader	8-8
8.2.1	Specifications	8-8
8.2.2	USB port on the inverter unit.....	8-9

Chapter 9 TROUBLESHOOTING

9.1	Protective Functions.....	9-1
9.2	Before Proceeding with Troubleshooting.....	9-2
9.3	If an Alarm Code Appears on the Monitor.....	9-3
9.3.1	Alarm Codes	9-3
9.3.2	If the "Light Alarm" Indication Appears.....	9-22
9.4	Nothing appears on the monitor.....	9-24
9.4.1	Abnormal motor operation.....	9-24
9.4.2	Problems with inverter settings.....	9-31
9.5	If Other than an Alarm Code is Displayed.....	9-33

Chapter 10 MAINTENANCE AND INSPECTION

10.1	Daily Inspection.....	10-1
10.2	Periodic Inspection.....	10-1
10.3	List of Periodic Replacement Parts.....	10-3
10.3.1	Judgment on service life.....	10-4
10.4	Measurement of Electrical Amounts in Main Circuit.....	10-8
10.5	Insulation Test.....	10-9
10.6	Cooling Fan Replacement Procedure.....	10-10

Chapter 11 CONFORMITY WITH STANDARDS

11.1	Compliance with European Standards.....	11-1
11.1.1	Conformity to the Low Voltage Directive in the EU.....	11-2
11.1.2	Compliance with EMC Standards.....	11-8
11.1.2.1	General.....	11-8
11.1.2.2	Recommended installation procedure.....	11-8
11.1.2.3	Leakage current of the EMC filter.....	11-10
11.1.3	Harmonic Component Regulation in the EU.....	11-14
11.1.3.1	General.....	11-14
11.1.3.2	Compliance with IEC/EN 61000-3-2.....	11-14
11.1.3.3	Compliance with IEC/EN 61000-3-12.....	11-14
11.2	Conformity with UL Standards and cUL-listed for Canada.....	11-15
11.2.1	General.....	11-15
11.2.2	Conformity with UL standards and cUL-listed for Canada.....	11-15

Appendices

App. A	Advantageous Use of Inverters (Notes on electrical noise).....	1
A.1	Effect of inverters on other devices.....	1
A.2	Noise.....	3
A.3	Noise prevention.....	5
App. B	Effect on Insulation of General-purpose Motors Driven with 400 V Class Inverters.....	13
B.1	Generating mechanism of surge voltages.....	13
B.2	Effect of surge voltages.....	14
B.3	Countermeasures against surge voltages.....	14
B.4	Regarding existing equipment.....	15
App. C	Inverter Generating Loss.....	16
App. D	Connection Notes at Inverter Replacement Time (Using the high power factor PWM converter, RHC series).....	18

Chapter 1

About FRENIC-HVAC

This chapter describes the features, control system, outer appearance and recommended configuration of peripheral equipment for FRENIC-HVAC.

Contents

- 1.1 Features..... 1-1
- 1.2 Inspection of goods and product appearance 1-13
 - 1.2.1 Inspection of goods 1-13
 - 1.2.2 Product appearance 1-15

1.1 Features

■ Overview

FRENIC-HVAC is Fuji Electric's first "slim-type inverter specially designed for saving energy." The device is ideal for all kinds of applications related to systems for supplying water and treating wastewater.

Achieving significant energy savings in HVAC by the optimal control.



- **Wide capacity range**

- 1 to 125 HP / 230V
- 1 to 1000 HP / 460V
- 1 to 300 HP / 575V

- **Protective structure**

- NEMA UL type1/ type12
- Open type

- **Equipped with DC reactor (DCR) / EMC filter**

Inverter capacity	EMC filter	DC reactor	Enclosure
1 to 60 HP (Three-phase 230V series) 1 to 125 HP (Three-phase 460V series) 1 to 150 HP (Three-phase 575V series)	Built-in	Built-in	NEMA UL type1 / type12
075 to 125 HP (Three-phase 230V series) 150 to 1000 HP (Three-phase 460V series) 200 to 300 HP (Three-phase 575V series)	Built-in	Standard accessory	Open

DCR : IEC/EN 61000-3-2, IEC/EN 61000-3-12

■ Functions suitable for HVAC use

- 4PID control
- Fire mode (Forced operation)
- Pick-up operation function
- Customizable logic
- Regenerative avoidance control
- Real time clock
- Overload avoidance control
- Commercial operation switching
- Command loss detection
- Low torque detection
- Low torque detection
- Slow flowrate stop function
- Password function
- Filter clogging prevention function
- Automatic energy-saving operation
- Wet-bulb temperature presumption control
- Linearization function
- Torque vector control

● 4PID control (standardly equipped with 4PID)

· PID control (for process)

Can be used by switching 2 types of process commands and feedback value. “Filter clogging / anti-jam, deviation alarm / absolute value alarm output” have been added to PID regulator that conducts temperature, pressure or flow rate control, etc. An anti-reset wind-up function to prevent PID control overshoot and PID control function that can be easily adjusted by PID limiter or integral fold / reset signal are furthermore employed.

PID control (process) block diagram

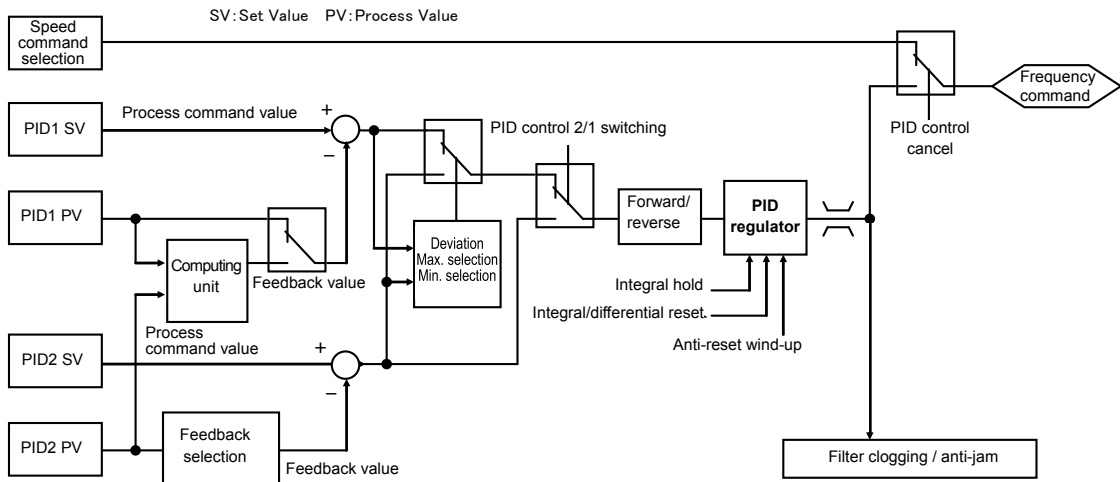

· External PID control (process)

Equipped with 3 built-in external PID controllers. You can independently control external actuators such as dampers and valves. An externally mounted PID controller is no longer required, thereby enabling cost reduction.

External PID control (process) block diagram

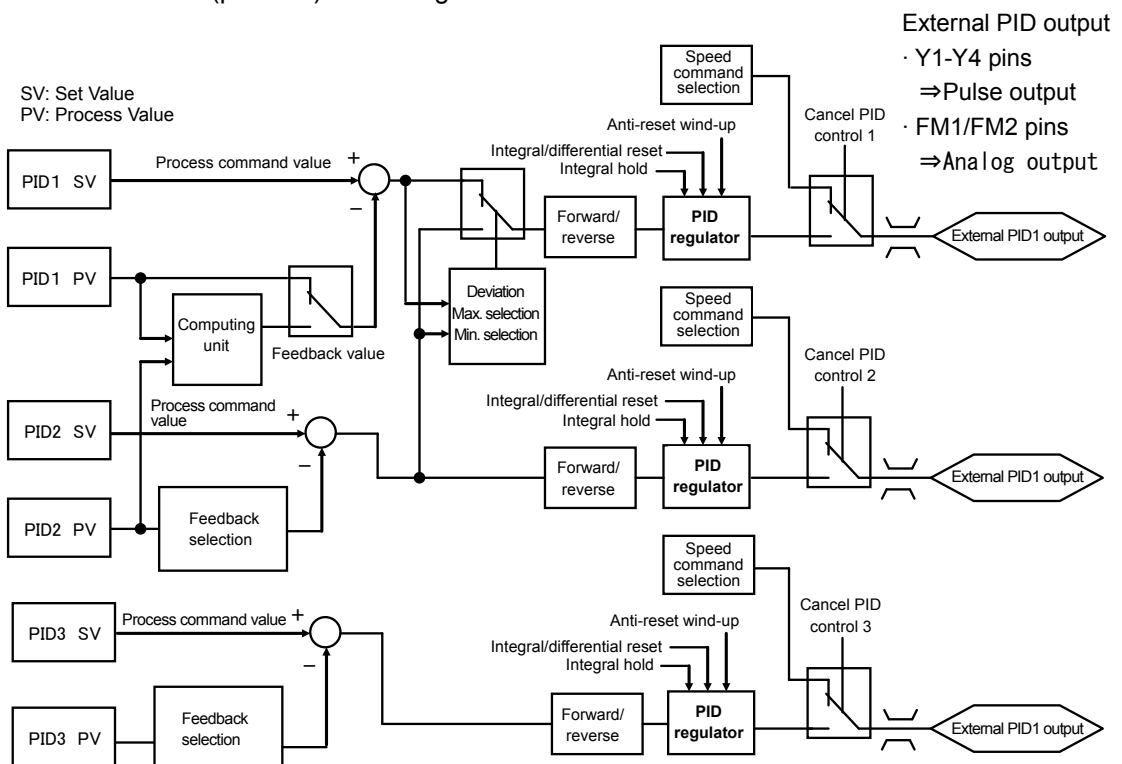

- **Fire Mode (forced operation)**

Alarm is ignored and operation continues until the inverter is damaged, and evacuation route is secured without smoke permeation.

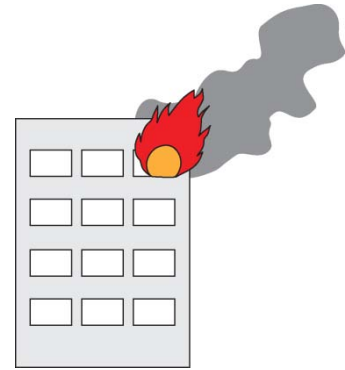

- **Pick-up operation function (speed sensor)**

Smooth start by pick-up function.

If operating fan while operating without a load when the inverter is not operating, pick-up is executed smoothly by searching for speed regardless of rotation direction. Convenient function when instantaneously switching from commercial power supply to inverter or restarting from instantaneous power failure.

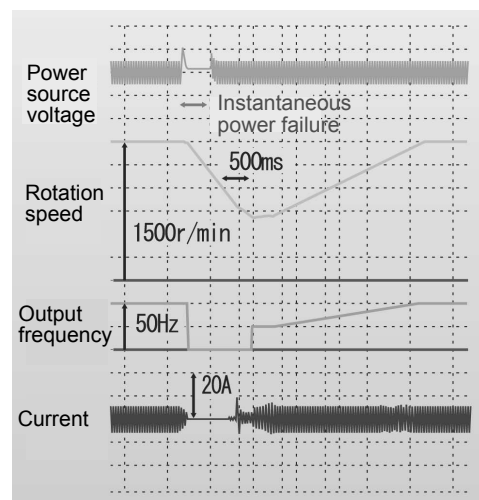

• Customizable logic

The customizable logic interface function is provided to the inverter body. This enables forming of logic circuit and arithmetic circuit to the digital and analog input and output signals, allowing simple relay sequence to be built while processing the signals freely.

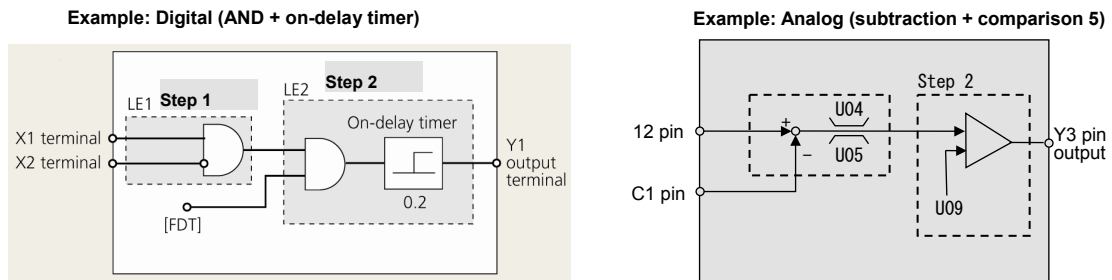

Item	Content
Logic function	<Digital> AND, OR, XOR, flip-flop, rise/fall detection, counter, etc. <Analog> Addition, subtraction, multiplication, limiter, absolute value, inverted addition, comparison, max. value selection, min. value selection, avg., scale conversion
General-purpose timer	On-delay, off-delay, pulse train, etc. Time setting: 0.0–600s
Input/output signal	Terminal input/output, inverter control function
Others	Can comprise up to 14 steps, with each step input/output occurring in combination You can check the input/output status of the various steps by the keypad having the LCD monitor.

< LCD monitor example >

* Numerical values of the screen display are not the same as in actual circumstances.

Digital + digital + timer (AND circuit + on-delay timer)	Analog + analog + limiter (Multiplication circuit + vertical limiter)	Analog + analog + comparison (Deviation comparison 2)
Digital + digital + counter (Up counter)	Function code + scale conversion	Analog + 1 input + conversion (Conversion 1)

● **Trip-less by regenerative avoidance control** (effective for acceleration, deceleration and fixed speed)

Because amount of energy to be regenerated to the inverter is limited and acceleration/deceleration time is controlled, equipment can be operated without overvoltage trip.

<Example: Operation when decelerating>

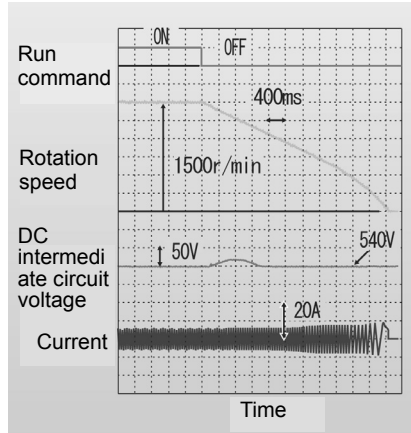

● **Standardly equipped with Real time clock (RTC)**

- Alarm information date/time display
- Timer operation function
- You can set up to 4 timers by units of 1 week.
- Holiday setting (20 days a year) is also possible.
- Daylight saving time auxiliary function
- Battery (optional) * Battery connection status displayed on the LCD monitor.

When operation is performed in the same schedule through a week

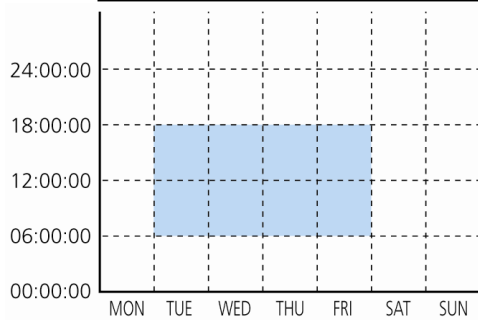

When operation schedule varies depending on the day of the week

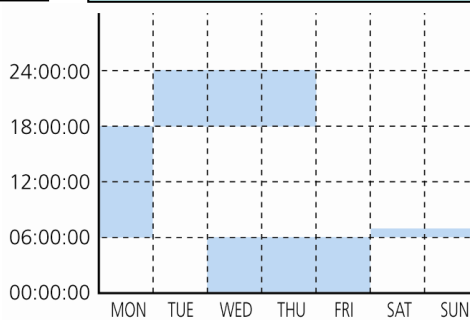

● **Continued operation of equipment by overload avoidance control**

If the inverter becomes overloaded in the case where inverter internal temperature rises radically from increased load or ambient temperature rises abnormally, operation is continued by reducing the load by reducing motor speed.

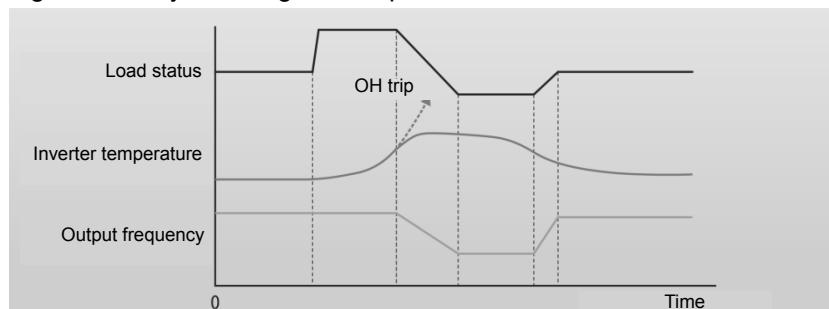

• Commercial operation switching

Because the inverter is equipped with a commercial frequency start processing function for switching commercial / inverter operation by external sequence, peripheral equipment configuration can be simplified. The inverter is equipped with 2 types of commercial operation switching sequences: Fuji standard and inverter alarm automatic commercial switching sequence.

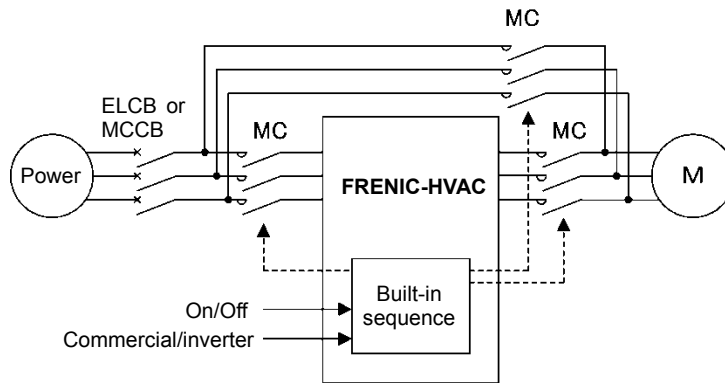

• Operation signal trouble is also avoided by command loss detection function.

If the frequency signal connected to the inverter (0 - 10V, 4 - 20 mA, multiple stage speed operation signal, communication, etc.) is blocked, the fact that frequency command has been lost is output as a "command loss" signal. You can furthermore set output frequency for command loss in advance, so the equipment can continue to operate even if the frequency signal is cut off by mechanical vibration, etc.

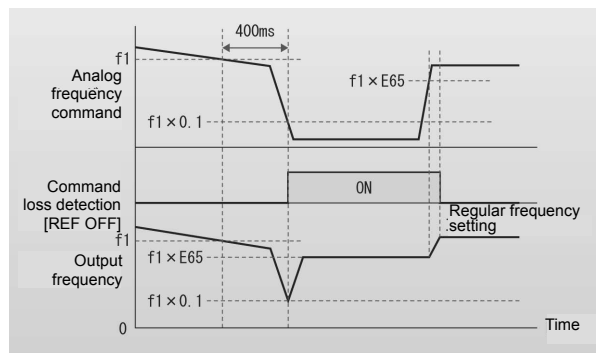

• Low torque detection also possible

If a problem such as fan belt breaking and load connected to the motor becomes exponentially lighter all of a sudden, detects that torque has dropped and outputs it as an output signal. Abnormal status of the equipment can be detected using this signal, so it can be utilized as equipment maintenance information.

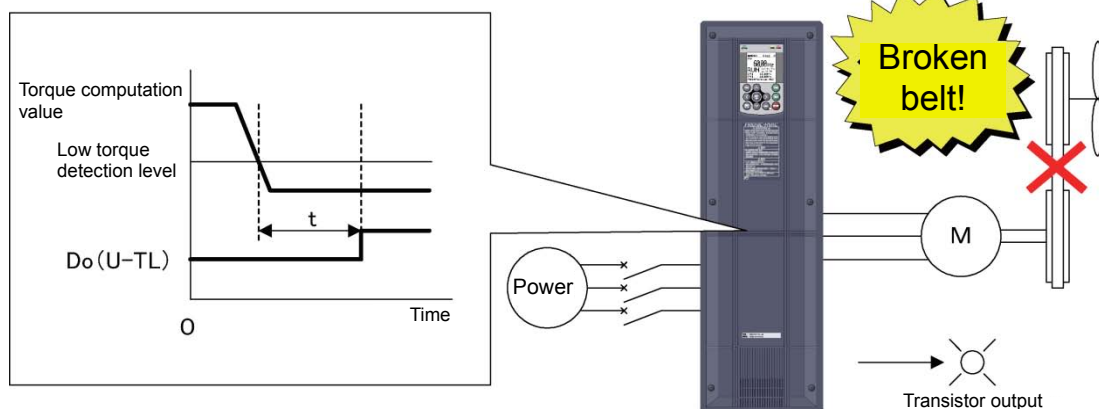

● **Password function**

Function codes can be read/write, displayed or hidden by setting the two passwords. This prevents erroneous operation or overwriting of function codes. In addition, if a wrong password was input exceeding the specified number of times, the inverter is restricted from operating as the user is regarded as improper.



● **Filter clogging prevention function**

This function detects clogging of the fan filter with dust or other materials using the output current and pressure sensor value. When clogging is detected, the fan is rotated in reverse to eject dust, and then resumes rotation in forward to blow air. In addition, the function notifies you of maintenance necessity with the alarm signal.

■ **Equipped with function that contributes to energy conservation.**

● **Automatic energy-saving operation**

Considering that fact that “control that minimizes motor loss” has evolved and the loss of the inverter itself, the device has been “equipped with a new type of control to minimize loss of the motor plus the inverter” to further conserve electric power for fan and pump applications.

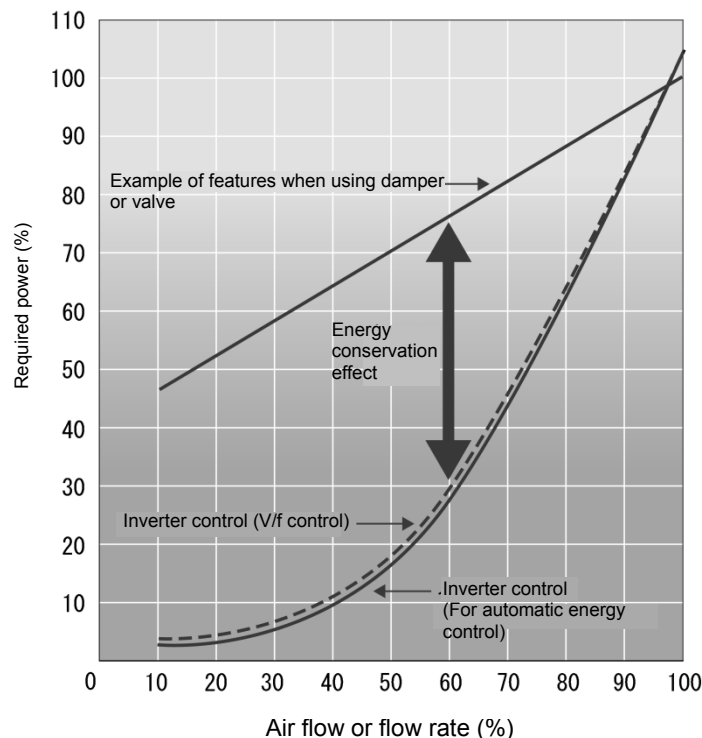

*Effect differs according to motor characteristics

Example of energy saving effect characteristics

• Wet-bulb temperature presumption control

This function is optimal for controlling the fan of cooling tower. Since the wet-bulb temperature would become higher than the set temperature when the air temperature is particularly high, water temperature will not reach the set temperature. Therefore, the fan keeps rotating at high speed, failing in energy-saving operation. FRENIC-HVAC automatically estimates the wet-bulb temperature and controls the fan so that the cooling water is interlocked with the air temperature in order not to use unnecessary electric power.

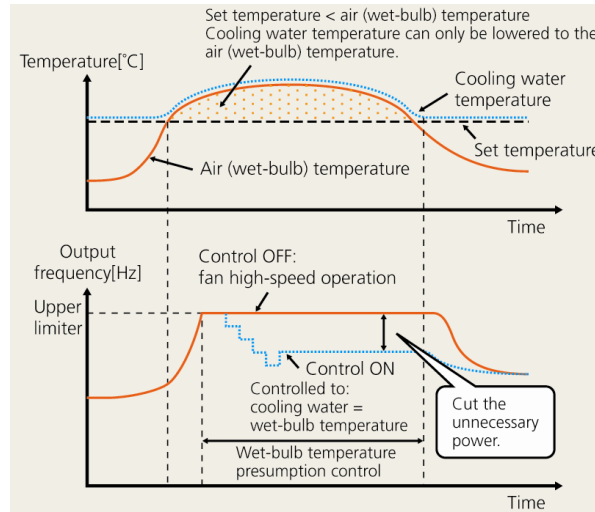

● **Linearization function**

This function estimates the target pressure using the load flow rate, which allows the estimated terminal pressure to be controlled. For an air-conditioning heat source system, the needed quantity of the cooling or heating water fluctuates generally in seasons or days and nights. Therefore, operations continuing in a water conveyance pressure constant control may lead to high operating unnecessary pressures on terminals at low operating state. Thus, the pump consumes an ineffectual electric power for maintaining the high water conveyance pressure.

↓

Based on the calculated value and water conveyance pressure of estimated terminal pressure using the detected load flow rate, PID control is performed.

↓

It is possible to reduce the ineffectual pump power consumption and to achieve a great energy-saving effect together with maintaining comfortable current air conditioning.

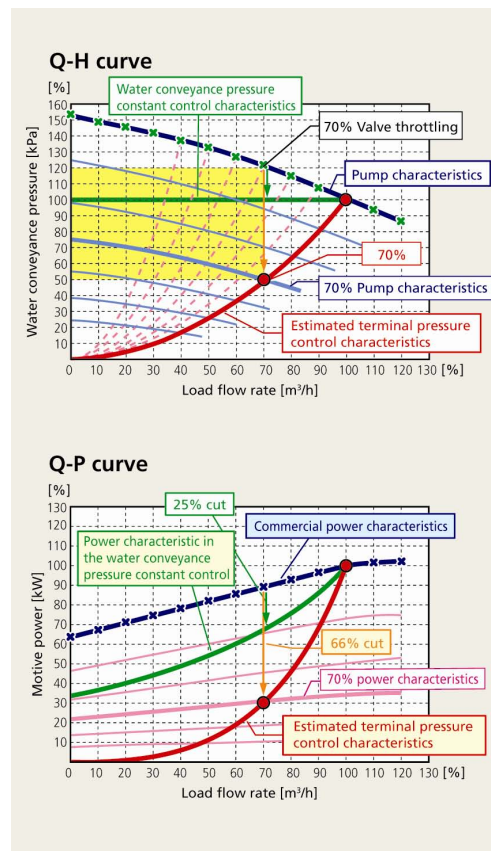
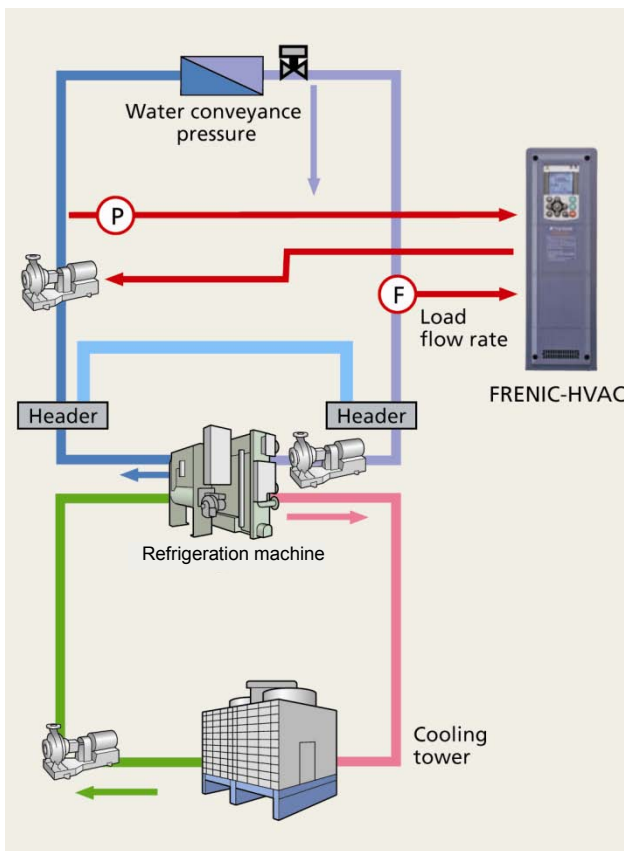

■ **Enhanced network support**

● **Standard equipment**

- Modbus RTU
- Metasys N2
- BACnet

● **Optional cards**

- PROFIBUS-DP
- CC-Link
- DeviceNet
- CANopen
- LONWORKS
- Ethernet

■ **Simple and enhanced maintenance / enhanced protective functions.**

- Information concerning life of consumable inverter parts is displayed.

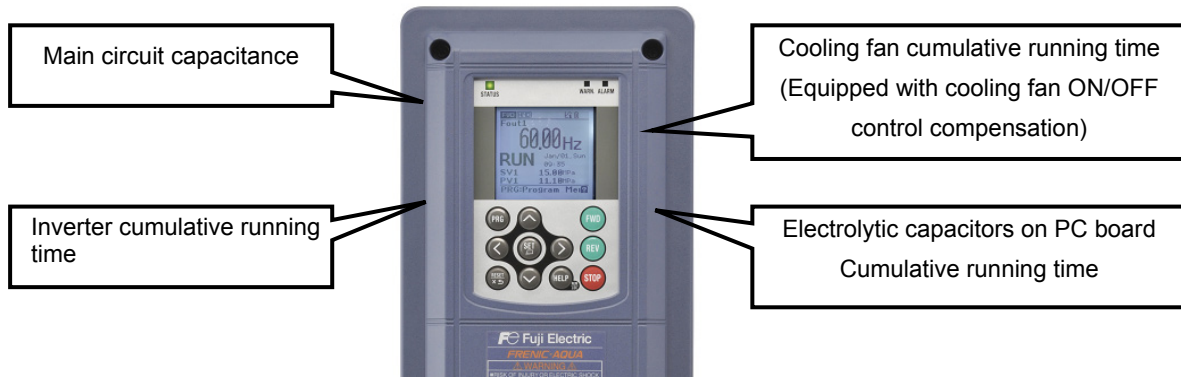

- **Life warning signal can be output to transistor output.**

Output when the end of service life of main circuit capacitors, electrolytic capacitors on PC board, cooling fan, or real time lock battery (optional) approaches.

- **Information taking equipment maintenance into account is also displayed.**

Information is added to maintenance information for the inverter itself and information taking equipment maintenance into account is also displayed.

Item	Objective
Motor cumulative running time (h)	Keeps track of time that equipment (motor) using the inverter is actually running. (Usage example) If used for fan control, it approximates the time for replacement of belts used for pulleys.
Startup count (times)	Counts the number of times the inverter is turned on and off. (Usage example) Because it keeps a record of how many times the equipment is turned on and off, it approximates the times for replacement of equipment parts that place a load on machinery when turned on and off.

- **You can check alarm history for the past 10 times (latest and 9 past times).**

Detailed information can also be checked for the past 4 times.

If using a real time clock, you can check the date and time of occurrence.

- **Employs detachable interface board (terminal block for control signal line)**

● **Motor protection by PTC thermistor**

By connecting the Positive Temperature Coefficient (PTC) thermistor embedded in the motor to the C1 pin, motor temperature is detected to protect the motor by shutting off the inverter before the motor overheats. You can select whether to shut off the inverter (stop by alarm) or output alarm from transistor output by PTC protection level.

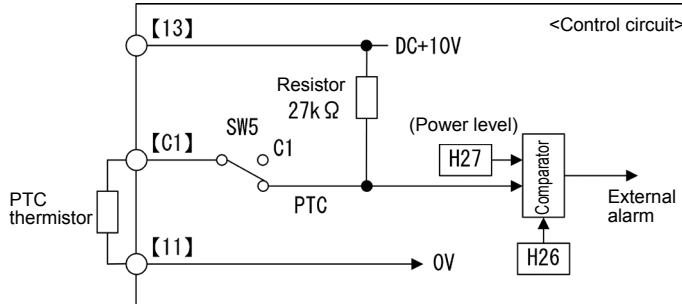

● **Easy cooling fan replacement**

Employs configuration that allows the fan to be mounted or dismantled by one simple operation to facilitate cooling fan replacement. (For the detailed replacement procedure, refer to Chapter 10, Section 10.6 "Cooling Fan Replacement Procedure.")

Cooling fan replacement procedure



Remove the cooling fan (with case).

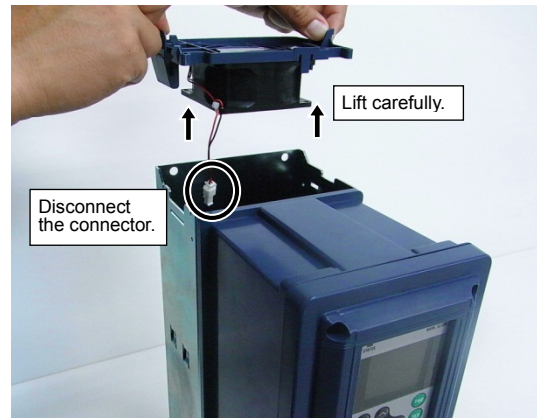

Remove cooling fan cable (connector).
Remove and replace the fan case and cooling fan.

- **Equipped with keypad employing large LCD.**
 - Realizes regulator display by enlargement of LCD.

- | | |
|----------------------------|-----------------------|
| 1. Present value (PV) | 6. Output voltage |
| 2. Setting value (SV) | 7. Torque |
| 3. Manipulating value (MV) | 8. Rotation speed |
| 4. Frequency | 9. Power consumption |
| 5. Output current | 10. Cumulative energy |

Unit setting function enables easy-to-understand display.



- **Multi-language supported: 19 languages + user customized language**

Language				
English	Chinese	German	French	Spanish
Italian	Russian	Greek	Turkish	Malay
Vietnamese	Thai	Indonesian	Polish	Czech
Swedish	Portuguese	Dutch	Japanese	

1.2 Inspection of goods and product appearance

1.2.1 Inspection of goods

Unpack the package and check the following:

- (1) An inverter and the following accessories are contained in the package.
Accessories: Instruction manual and CD-ROM manual
- (2) The inverter has not been damaged during transportation—there should be no dents or parts missing.
- (3) The inverter is the type you ordered. You can check the type and specifications on the main nameplate. (A total of four nameplates and warning plates are attached to the inverter as shown below.)

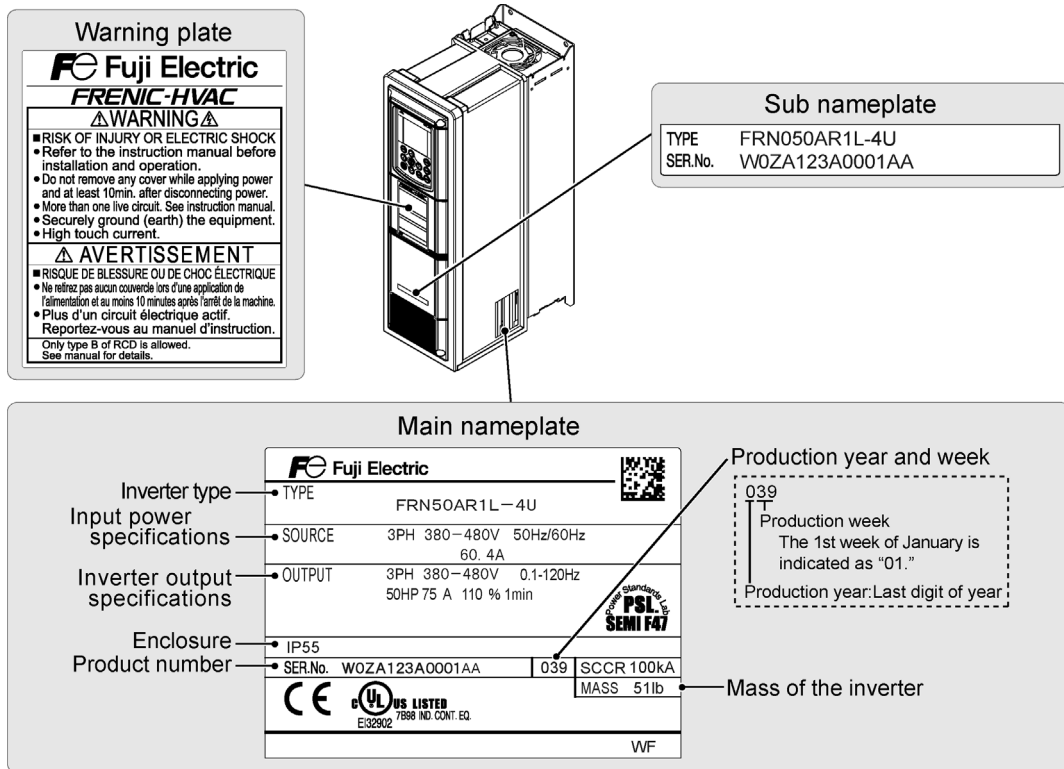

①Type: Inverter type

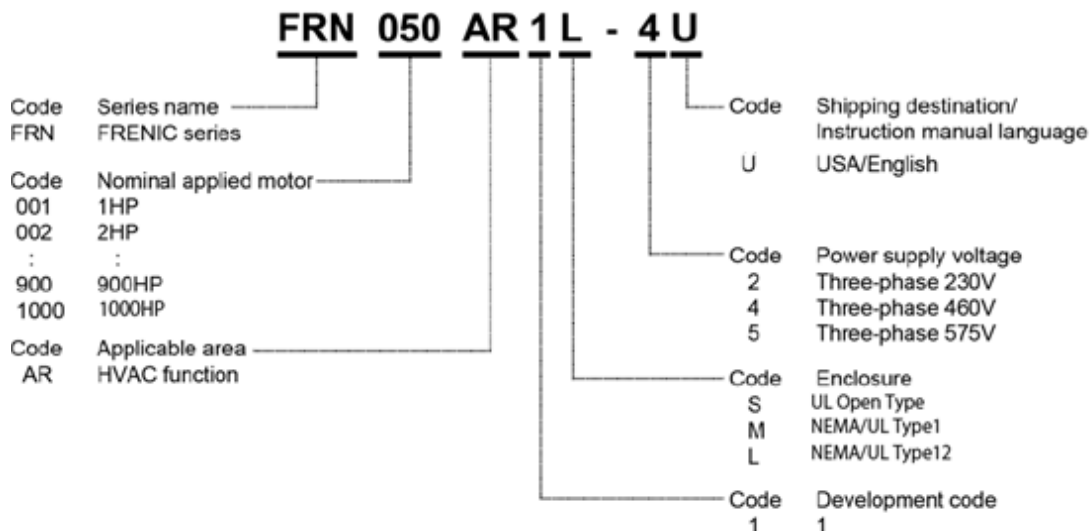

"Nominal applied motor" for USA models are represented in the HP unit.

②Source: Input power source specifications

No. of input phases (3PH in the case of 3 phases), input voltage, input frequency, input current

③Output: Inverter output specifications

No. of output phases, rated output voltage, output frequency range, output rated capacity, rated output current, overload current rating

④IP Code: Protective structure

⑤⑥Ser. No: Serial No. / Mfg. Year/week

W 1 8 A 1 2 3 A 0 0 1 A A

0 3 9

└─ The first week of mfg. week / January is "01."
This indicates which week it corresponds to.

└─ Mfg. year / last digit of year

⑦Mass: Mass

 Note Inverter type is indicated as "FRN***AR1■-2U/4U/5U" in the various tables in this document. The alphabetical character that indicates protective structure goes in ■.

If there is something you do not understand about the product or there is something wrong with it, please contact the dealership from where you purchased it or your nearest Fuji Electric sales office.

1.2.2 Product appearance

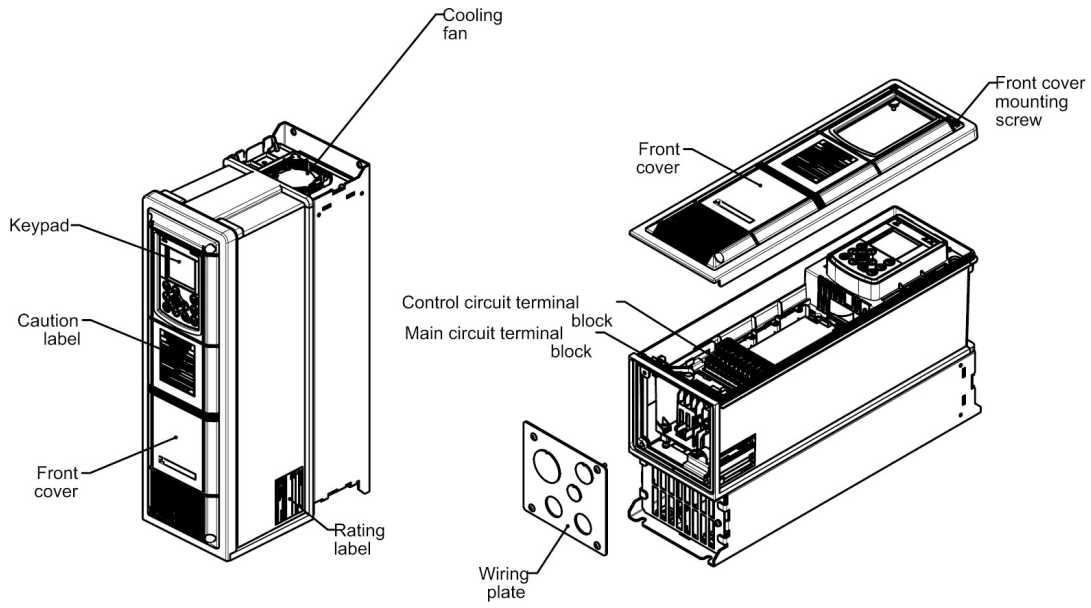

Fig. 1.1 FRN001AR1M-4U (NEMA/UL type1)

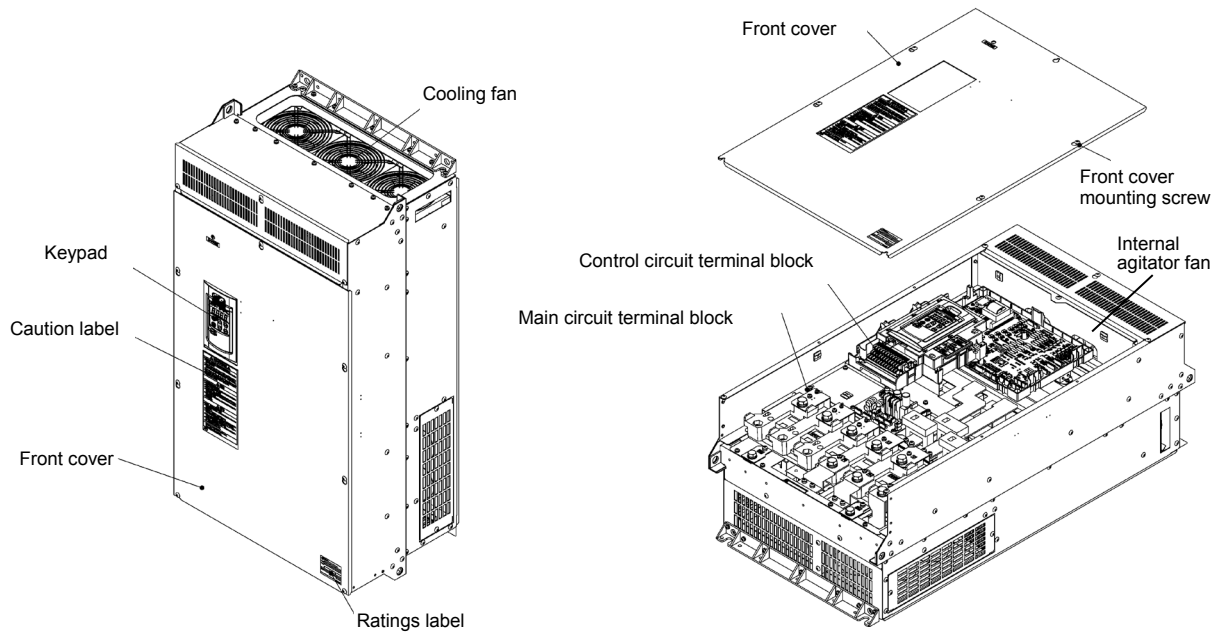

Fig. 1.2 FRN300AR1S-4U (UL open type)

Note: Refer to external drawings in chapter 2 for other capacities.

Chapter 2

SPECIFICATIONS

This chapter describes specifications of the output ratings, control system, and terminal functions for the FRENIC-HVAC series of inverters. It also provides descriptions of the operating and storage environment, precautions for using inverters, external dimensions, examples of basic connection diagrams, and details of the protective functions.

Contents

2.1	Standard Model FRENIC-HVAC.....	2-1
2.1.1	Three-phase 230 V class series (USA models).....	2-1
2.1.2	Three-phase 460 V class series (USA models).....	2-3
2.1.3	Three-phase 575 V class series (USA models).....	2-6
2.2	Common Specifications.....	2-9
2.3	Terminal Specifications.....	2-16
2.3.1	Terminal functions.....	2-16
2.3.2	Setting up the slide switches.....	2-26
2.3.3	Screw specifications and recommended wire sizes.....	2-28
2.3.3.1	Main circuit terminals.....	2-28
2.3.3.2	Control circuit terminals (Common to all inverter types).....	2-35
2.4	Conduits.....	2-36
2.4.1	Conduits.....	2-36
2.5	Leakage Current of the EMC Filter.....	2-39
2.6	Derating of Rated Output Current.....	2-42
2.7	Operating Environment and Storage Environment.....	2-44
2.7.1	Operating environment.....	2-44
2.7.2	Storage environment.....	2-45
2.7.2.1	Temporary storage.....	2-45
2.7.2.2	Long-term storage.....	2-45
2.8	Precautions for Using Inverters.....	2-46
2.8.1	Precautions in introducing inverters.....	2-46
2.8.2	Precautions in running inverters.....	2-50
2.8.3	Precautions in using special motors.....	2-50
2.9	External Dimensions.....	2-51
2.9.1	Standard models.....	2-51
2.9.2	Keypad.....	2-64
2.10	Connection Diagrams.....	2-65

2.1 Standard Model FRENIC-HVAC

2.1.1 Three-phase 230 V class series (USA models)

(001 to 125 HP)

Item			Specifications															
Type (FRN___AR1■-2U) (*1)			001	002	003	005	007	010	015	020	025	030	040	050	060	075	100	125
Nominal applied motor [HP] (*2) (Rated output)	Three phase input	AC208V motor	1	2	3	5	7.5	10	15	20	25	30	40	50	60	75	100	125
		AC230V motor	-	1/2	3/4	1.5	2	3	5	5	7.5	10	10	10	15	20	30	30
	Single phase input	AC208V motor	-	1/2	1	2	3	3	5	7.5	10	10	15	20	25	30	30	50
		AC230V motor	-	1/2	1	2	3	3	5	7.5	10	10	15	20	25	30	30	50
Output ratings	Three phase input	Rated capacity (kVA) (*3)	1.9	3.1	4.3	7.1	10	12	18	23	29	35	45	58	71	85	112	137
		Rated current (A)	5	8	11	18	27	31.8	46.2	59.4	74.8	88	115	146	180	215	283	346
	Single phase input	Rated capacity (kVA) (*3)	0.7	1.2	1.6	2.7	4.1	4.9	7.1	9.2	11	13	17	22	27	37	40	52
		Rated current (A)	1.9	3.1	4.2	7	10.5	12.4	18	23.1	29.1	34.3	44.8	56.9	70.2	95	102	131
Rated voltage (V) (*4)		Three-phase, 200 to 240 V (with AVR function)										Three-phase, 200 to 230 V (with AVR function)						
Overload capability		110%-1 min (Overload interval: Compliant with IEC 61800-2)																
Input power	Three phase input	Main power supply (number of phases, voltage, frequency)	Three-phase, 200 to 240 V, 50/60 Hz										Three-phase, 200 to 220 V, 50 Hz Three-phase, 200 to 230 V, 60 Hz					
		Rated current (A) (*5)	2.8	5.3	7.5	12.9	18.0	24.2	36.0	48.6	60.0	71.5	96.9	121	145	177	246	291
		Required power supply capacity [kVA]	1.2	2.2	3.0	5.2	7.2	10	15	20	24	29	39	49	58	71	98	116
	Single phase input	Main power supply (number of phases, voltage, frequency)	Single-phase, 200 to 240 V, 50/60 Hz										Single-phase, 200 to 220 V, 50 Hz Single-phase, 200 to 230 V, 60 Hz					
		Rated current [A] (*5)	2.8	5.3	7.5	12.9	18.0	24.2	36.0	48.6	60.0	71.5	96.9	121	145	177	246	291
		Required power supply capacity [kVA]	0.7	1.3	1.8	3.0	4.2	5.6	8.3	12	14	17	23	28	34	41	57	67
	Auxiliary control power supply: (number of phases, voltage, frequency)		Single-phase, 200 to 240 V, 50/60 Hz										Single-phase, 200 to 230 V, 50/60 Hz					
	Auxiliary main power supply (number of phases, voltage, frequency) (*6)		-										Single-phase, 200 to 220 V, 50 Hz Single-phase, 200 to 230 V, 60 Hz					
Voltage, frequency variations		Voltage: +10 to -15% (Interphase voltage unbalance : 2% or less) (*9), Frequency: +5 to -5%																
Braking	Braking torque [%] (*7)		20										10 to 15					
	DC injection braking		Braking start frequency: 0.0 to 60.0 Hz; Braking time: 0.0 to 30.0 s; Braking operation level: 0 to 60%															
EMC filter (IEC/EN 61800-3) (*8)		EMC standards compliance : Category C2 (emission) / 2nd Env. (Immunity)														C3/ 2nd		
DC reactor (DCR) (*8)		Built-in (IEC/EN 61000-3-2(*10), IEC/EN 61000-3-12)														Standard accessory (IEC/EN61000-3-12)		
Power factor (at the rated load)	Fundamental wave power factor		> 0.98															
	Total power factor		≥ 0.90															
Efficiency (at the rated load) (%)		97	97	97	97	97	98	98	98	98	98	98	98	98	98	98	98	98
Applicable (safety) standards		UL 508C, C22.2 No. 14, IEC/EN 61800-5-1 SEMI F47-0706																
Enclosure	NEMA/UL 50	NEMA/UL Type 1, NEMA/UL Type 12(*11)														UL open type		
Cooling method		Fan cooling																
Weight / Mass [lbs]	NEMA/UL Type 1	22	22	22	22	40	40	40	51	51	110	110	154	154	-			
	NEMA/UL Type 12	22	22	22	22	40	40	40	51	51	110	110	154	154	-			
	UL open type	-														93	95	137
Environmental Requirements	Site location		Indoors															
	Ambient temperature	UL open type / NEMA/UL Type 1	14 to 122°F															
		NEMA/UL Type 12	14 to 104°F															
	Relative humidity		5 to 95% (No condensation)															
	Atmosphere		The inverter must not be exposed to dust, direct sunlight, corrosive gases, flammable gases, oil mist, vapor or water drops. Pollution degree 2 (IEC/EN 60664-1) (*12) The atmosphere can contain a small amount of salt. (0.01 mg/cm ² or less per year) The inverter must not be subjected to sudden changes in temperature that will cause condensation to form.															
	Altitude		3,300 ft max. (*13)															
	Atmospheric pressure		86 to 106 kPa															
Vibration		60 HP or less 3 mm 2 to less than 9 Hz 10 m/s ² 9 to less than 200 Hz						75 to 100 HP 3 mm 2 to less than 9 Hz 9.8 m/s ² 9 to less than 20 Hz 2 m/s ² 20 to less than 55 Hz 1 m/s ² 55 to less than 200 Hz						125 HP 3 mm 2 to less than 9 Hz 2 m/s ² 9 to less than 55 Hz 1 m/s ² 55 to less than 200 Hz				

-
- (*1) A box (■) replaces an alphabetic letter depending on the enclosure.
 ■Enclosure: M (NEMA/UL Type1), L (NEMA/UL Type12) or S (UL Open Type)
 - (*2) US 4-pole standard induction motor.
 - (*3) Rated capacity is calculated by assuming the output rated voltage as 230 V.
 - (*4) Output voltage cannot exceed the power supply voltage. At single-phase input use, the output voltage may be lower than three-phase input.
 - (*5) The value is calculated on assumption that the inverter is connected with a power supply 230V, 50Hz and R_{sc}=120.
 - (*6) The auxiliary power input is used as an AC power input when combining the unit to DC power supply such as high power factor PWM converter with power regenerative function. (Generally not to be used.)
 - (*7) Average braking torque for the motor running alone. (It varies with the efficiency of the motor.)
 - (*8) EMC filters and DCR does not conform to each corresponding standards when single phase input use.
 - (*9) Voltage unbalance [%] = (Max. voltage [V] - Min. voltage [V])/Three-phase average voltage [V] x 67 (See IEC/EN61800-3.)
 If this value is 2 to 3%, use an optional AC reactor (ACR).
 - (*10) It is applicable when the power supply is supplied from 3-phase 200V series transformer which is through 3-phase 400V series transformer.
 - (*11) NEMA/UL Type 12 offers protection for short water jets. Do not use outdoors or in places where long-term waterproofing is required.
 - (*12) Do not install the inverter in an environment where it may be exposed to lint, cotton waste or moist dust or dirt which will clog the heat sink of the inverter. If the inverter is to be used in such an environment, install it in a dustproof panel of your system.
 - (*13) If you use the inverter in an altitude above 3300 ft, you should apply an output current derating factor as listed in the table below.

Altitude	3300 ft or lower	3300 to 4900 ft	4900 to 6600 ft	6600 to 8200 ft	8200 to 9800 ft
Output current derating factor	1.00	0.97	0.95	0.91	0.88

2.1.2 Three-phase 460 V class series (USA models)

(1 to 75 HP)

Item			Specifications													
Type (FRN__AR1-4U) (*1)			001	002	003	005	007	010	015	020	025	030	040	050	060	075
Nominal applied motor [HP] (*2) (Rated output)	Three phase input	AC460V motor	1	2	3	5	7.5	10	15	20	25	30	40	50	60	75
	Single phase input		-	1/2	1	2	3	3	5	7.5	10	10	15	20	25	30
Output ratings	Three phase input	Rated capacity (kVA) (*3)	1.9	3.2	4.3	7.1	10	14	19	25	31	35	47	59	72	89
		Rated current (A)	2.5	4.1	5.5	9.0	13.5	18.5	24.5	32	39	45	60	75	91	112
	Single phase input	Rated capacity (kVA) (*3)	-	1.1	1.6	2.7	4.1	5.7	7.5	9.8	12	13	18	23	28	34
		Rated current (A)	-	1.5	2.1	3.5	5.2	7.2	9.5	12.4	15.2	17.5	23.4	29.2	35.4	43.6
Rated voltage (V) (*4)			Three-phase, 380 to 480 V (with AVR function)													
Overload capability			110%-1 min (Overload interval: Compliant with IEC 61800-2)													
Input power	Three phase input	Main power supply (number of phases, voltage, frequency)	Three-phase, 380 to 480 V, 50/60 Hz												Three-phase, 380 to 440 V, 50 Hz Three-phase, 380 to 480 V, 60 Hz	
		Rated current (A) (*5)	1.4	2.7	3.8	6.5	9.0	12.1	18.0	24.3	30.0	35.8	48.5	60.4	72.3	88.7
		Required power supply capacity [kVA]	1.2	2.2	3.1	5.2	7.2	10	15	20	24	29	39	49	58	71
	Single phase input	Main power supply (number of phases, voltage, frequency)	Single-phase, 380 to 480 V, 50/60 Hz												Single-phase, 380 to 440 V, 50 Hz Single-phase, 380 to 480 V, 60 Hz	
		Rated current [A] (*5)	-	2.7	3.8	6.5	9.0	12.1	18.0	24.3	30.0	35.8	48.5	60.4	72.3	88.7
		Required power supply capacity [kVA]	-	1.3	1.8	3.0	4.2	5.6	8.3	12	14	17	23	28	34	41
	Auxiliary control power supply: (number of phases, voltage, frequency)			Single-phase, 380 to 480 V, 50/60 Hz												
Auxiliary main power supply (number of phases, voltage, frequency) (*6)			-												Single-phase, 380 to 440 V, 50 Hz Single-phase, 380 to 480 V, 60 Hz	
Voltage, frequency variations			Voltage: +10 to -15% (Interphase voltage unbalance : 2% or less) (*9), Frequency: +5 to -5%													
Braking	Braking torque [%] (*7)		20										10 to 15			
	DC injection braking		Braking start frequency: 0.0 to 60.0 Hz; Braking time: 0.0 to 30.0 s; Braking operation level: 0 to 60%													
EMC filter (IEC/EN 61800-3) (*8)			EMC standards compliance : Category C2 (emission) / 2nd Env. (Immunity)													
DC reactor (DCR) (*8)			Built-in (IEC/EN 61000-3-2(*10), IEC/EN 61000-3-12)													
Power factor (at the rated load)	Fundamental wave power factor		> 0.98													
	Total power factor		≥ 0.90													
Efficiency (at the rated load) (%)			95	96	97	97	97	97	97	97	98	98	98	98	98	98
Applicable (safety) standards			UL 508C, C22.2 No. 14, IEC/EN 61800-5-1, SEMI F47-0706													
Enclosure		NEMA/UL 50	NEMA/UL Type 1, NEMA/UL Type 12 (*11)													
Cooling method			Fan cooling													
Weight / Mass [lbs]	NEMA/UL Type 1		22	22	22	22	22	22	40	40	40	40	51	51	110	110
	NEMA/UL Type 12		22	22	22	22	22	22	22	40	40	40	40	51	51	110
UL open type			-													
Environmental Requirements	Site location		Indoors													
	Ambient temperature	UL open type / NEMA/UL Type 1	14 to 122°F													
		NEMA/UL Type 12	14 to 104°F													
	Relative humidity		5 to 95% (No condensation)													
	Atmosphere		The inverter must not be exposed to dust, direct sunlight, corrosive gases, flammable gases, oil mist, vapor or water drops. Pollution degree 2 (IEC/EN 60664-1) (*12) The atmosphere can contain a small amount of salt. (0.01 mg/cm ² or less per year) The inverter must not be subjected to sudden changes in temperature that will cause condensation to form.													
	Altitude		3,300 ft max. (*13)													
	Atmospheric pressure		86 to 106 kPa													
Vibration		3mm 2 to less than 9 Hz 10 m/s ² 9 to less than 200 Hz														

(100 to 1000 HP)

Item			Specifications												
Type (FRN AR1-4U) (*1)			100	125	150	200	250	300	350	450	500	600	800	900	1000
Nominal applied motor (HP) (*2) (Rated output)	Three phase input	AC460V motor	100	125	150	200	250	300	350	450	500	600	800	900	1000
	Single phase input		40	50	60	75	75	100	125	150	200	200	300	350	450
Output ratings	Three phase input	Rated capacity (kVA) (*3)	119	140	167	201	242	300	330	414	517	589	764	932	1091
		Rated current (A)	150	176	210	253	304	377	415	520	650	740	960	1170	1370
	Single phase input	Rated capacity (kVA) (*3)	46	54	65	78	94	117	128	160	201	229	297	363	425
		Rated current (A)	58.5	68.6	81.9	98.6	118	147	161	202	253	288	374	456	534
Rated voltage (V) (*4)		Three-phase, 380 to 480 V (with AVR function)													
Overload capability		110%-1 min (Overload interval: Compliant with IEC 61800-2)													
Input power	Three phase input	Main power supply (number of phases, voltage, frequency)	Three-phase, 380 to 440 V, 50 Hz Three-phase, 380 to 480 V, 60 Hz												
		Rated current (A) (*5)	119	141	175	207	249	311	340	435	547	614	767	970	1093
		Required power supply capacity [kVA]	95	113	140	165	199	248	271	347	436	490	612	773	871
	Single phase input	Main power supply (number of phases, voltage, frequency)	Single-phase, 380 to 440 V, 50 Hz Single-phase, 380 to 480 V, 60 Hz												
		Rated current [A] (*5)	119	141	175	207	249	311	340	435	547	614	767	970	1093
	Required power supply capacity [kVA]		55	65	81	96	115	144	157	201	252	282	353	447	503
Auxiliary control power supply: (number of phases, voltage, frequency)		Single-phase, 380 to 480 V, 50/60 Hz													
Auxiliary main power supply (number of phases, voltage, frequency) (*6)		Single-phase, 380 to 440 V, 50 Hz Single-phase, 380 to 480 V, 60 Hz													
Voltage, frequency variations		Voltage: +10 to -15% (Interphase voltage unbalance : 2% or less) (*9), Frequency: +5 to -5%													
Braking	Braking torque [%] (*7)		10 to 15												
	DC injection braking		Braking start frequency: 0.0 to 60.0 Hz; Braking time: 0.0 to 30.0 s; Braking operation level: 0 to 60%												
EMC filter (IEC/EN 61800-3) (*8)			C2/2nd			EMC standards compliance: Category C3 (emission) / 2nd Env. (Immunity)									
DC reactor (DCR) (*8)			Built-in (IEC/EN 61000-3-2 (*10), IEC/EN 61000-3-12)			Standard accessory (IEC/EN 61000-3-12)									
Power factor (at the rated load)	Fundamental wave power factor		> 0.98												
	Total power factor		≥ 0.90												
Efficiency (at the rated load) (%)			98	98	98	98	98	98	98	98	98	98	98	98	98
Safety standard compliance			UL 508C, C22.2 No. 14, IEC/EN 61800-5-1, SEMI F47-0706												
Enclosure	NEMA/UL 50		NEMA/UL Type 1, NEMA/UL Type 12(*11)			UL open type									
	Cooling method		Fan cooling												
Weight / Mass [lbs]	NEMA/UL Type 1		154	154											
	NEMA/UL Type 12		154	154											
UL open type			-	-	137	141	207	216	284	309	540	540	728	1168	1168
Environmental Requirements	Site location		Indoors												
	Ambient temperature	UL open type / NEMA/UL Type 1	14 to 122°F												
		NEMA/UL Type 12	14 to 122°F												
	Relative humidity		5 to 95% (No condensation)												
	Atmosphere		The inverter must not be exposed to dust, direct sunlight, corrosive gases, flammable gases, oil mist, vapor or water drops. Pollution degree 2 (IEC/EN 60664-1) (*12) The atmosphere can contain a small amount of salt. (0.01 mg/cm ² or less per year) The inverter must not be subjected to sudden changes in temperature that will cause condensation to form.												
	Altitude		3,300 ft max. (*13)												
Atmospheric pressure		86 to 106 kPa													
Vibration		100 to 125 HP or less 3mm 2 to less than 9 Hz 10 m/s ² 9 to less than 200 Hz						150 to 1000 HP 3mm 2 to less than 9 Hz 2m/s ² 9 to less than 55 Hz 1m/s ² 55 to less than 200 Hz							

- (*1) A box (■) replaces an alphabetic letter depending on the enclosure.
 ■Enclosure: M (NEMA/UL Type1), L (NEMA/UL Type12) or S (UL Open Type)
- (*2) US 4-pole standard induction motor.
- (*3) Rated capacity is calculated by assuming the output rated voltage as 460 V.
- (*4) Output voltage cannot exceed the power supply voltage. At single-phase input use, the output voltage may be lower than three-phase input.
- (*5) The value is calculated on assumption that the inverter is connected with a power supply 460V, 50Hz and Rsc=120.
- (*6) The auxiliary power input is used as an AC power input when combining the unit to DC power supply such as high power factor PWM converter with power regenerative function. (Generally not to be used.)
- (*7) Average braking torque for the motor running alone. (It varies with the efficiency of the motor.)
- (*8) EMC filters and DCR does not conform to each corresponding standards when single phase input use.
- (*9) Voltage unbalance [%] = (Max. voltage [V] - Min. voltage [V])/Three-phase average voltage [V] x 67 (See IEC/EN 61800-3.)
 If this value is 2 to 3%, use an optional AC reactor (ACR).
- (*10) It is applicable when the power supply is supplied from 3-phase 200V series transformer which is through 3-phase 400V series transformer.
- (*11) NEMA/UL Type 12 offers protection for short water jets. Do not use outdoors or in places where long-term waterproofing is required.
- (*12) Do not install the inverter in an environment where it may be exposed to lint, cotton waste or moist dust or dirt which will clog the heat sink of the inverter. If the inverter is to be used in such an environment, install it in a dustproof panel of your system.
- (*13) If you use the inverter in an altitude above 3300 ft, you should apply an output current derating factor as listed in the table below.

Altitude	3300 ft or lower	3300 to 4900 ft	4900 to 6600 ft	6600 to 8200 ft	8200 to 9800 ft
Output current derating factor	1.00	0.97	0.95	0.91	0.88

2.1.3 Three-phase 575 V class series (USA models)

(001 to 050 HP)

Item			Specifications											
Type (FRN__AR1-5U) (*1)			001	002	003	005	007	010	015	020	025	030	040	050
Nominal applied motor [HP] (*2) (Rated output)	Three phase input	AC575V motor	1	2	3	5	7.5	10	15	20	25	30	40	50
	Single phase input		-	1/2	3/4	1.5	2	3	5	5	7.5	10	10	15
Output ratings	Three phase input	Rated capacity (kVA) (*3)	1.6	2.7	3.8	6.1	9.2	11	16	21	26	31	40	51
		Rated current (A)	1.7	2.8	3.9	6.2	9.3	12	17	22	27	32	41	52
	Single phase input	Rated capacity (kVA) (*3)	-	0.9	1.4	2.3	3.5	4.5	6.5	8.4	10	12	15	20
		Rated current (A)	-	1.0	1.5	2.4	3.6	4.6	6.6	8.5	10.5	12.4	15.9	20.2
Rated voltage (V) (*4)			Three-phase, 575 to 600 V (with AVR function)											
Overload capability			110%-1 min (Overload interval: Compliant with IEC 61800-2)											
Input power	Three phase input	Main power supply (number of phases, voltage, frequency)	Three-phase, 575 to 600 V, 50/60 Hz											
		Rated current (A) (*5)	1.2	2.1	3.0	5.2	7.2	9.7	14.4	19.5	24.0	28.6	38.8	48.3
		Required power supply capacity [kVA]	1.2	2.1	3.0	5.2	7.2	10	15	20	24	29	39	49
	Single phase input	Main power supply (number of phases, voltage, frequency)	Single-phase, 575 to 600 V, 50/60 Hz											
		Rated current [A] (*5)	-	2.1	3.0	5.2	7.2	9.7	14.4	19.5	24.0	28.6	38.8	48.3
		Required power supply capacity [kVA]	-	1.3	1.8	3.0	4.2	5.6	8.3	12	14	17	23	28
	Auxiliary control power supply: (number of phases, voltage, frequency)		Single-phase, 575 to 600 V, 50/60 Hz											
Auxiliary main power supply (number of phases, voltage, frequency) (*6)		-												
Voltage, frequency variations			Voltage: +10 to -15% (Interphase voltage unbalance : 2% or less) (*9), Frequency: +5 to -5%											
Braking	Braking torque [%] (*7)		20											10 to 15
	DC injection braking		Braking start frequency: 0.0 to 60.0 Hz; Braking time: 0.0 to 30.0 s; Braking operation level: 0 to 60%											
	EMC filter (IEC/EN 61800-3) (*8)		EMC standards compliance : Category C3 (emission) / 2nd Env. (Immunity)											
	DC reactor (DCR) (*8)		Built-in (IEC/EN 61000-3-2(*10), IEC/EN 61000-3-12)											
Power factor (at the rated load)	Fundamental wave power factor	> 0.98												
	Total power factor	≥ 0.90												
Efficiency (at the rated load) (%)		95	96	97	97	97	97	97	97	97	98	98	98	98
Applicable (safety) standards		UL 508C, C22.2 No. 14, IEC/EN 61800-5-1												
Enclosure		NEMA/UL 50		NEMA/UL Type 1, NEMA/UL Type 12(*11)										
Cooling method		Fan cooling												
Weight / Mass [lbs]	NEMA/UL Type 1		22	22	22	22	22	22	40	40	40	40	51	51
	NEMA/UL Type 12		22	22	22	22	22	22	40	40	40	40	51	51
	UL open type		-											
Environmental Requirements	Site location		Indoors											
	Ambient temperature	UL open type / NEMA/UL Type 1	14 to 122°F											
		NEMA/UL Type 12	14 to 104°F											
	Relative humidity		5 to 95% (No condensation)											
	Atmosphere		The inverter must not be exposed to dust, direct sunlight, corrosive gases, flammable gases, oil mist, vapor or water drops. Pollution degree 2 (IEC/EN 60664-1) (*12) The atmosphere can contain a small amount of salt. (0.01 mg/cm ² or less per year) The inverter must not be subjected to sudden changes in temperature that will cause condensation to form.											
	Altitude		3,300 ft max. (*13)											
	Atmospheric pressure		86 to 106 kPa											
Vibration		3mm 2 to less than 9 Hz 10 m/s ² 9 to less than 200 Hz												



(060to 300HP)

Item			Specifications							
Type (FRN ___ AR1■-5U) (*1)			060	075	100	125	150	200	250	300
Nominal applied motor [HP] (*2) (Rated output)	Three phase input	AC575V motor	60	75	100	125	150	200	250	300
	Single phase input		20	25	30	40	50	75	100	100
Output ratings	Three phase input	Rated capacity (kVA) (*3)	62	76	103	124	145	210	260	287
		Rated current (A)	63	77	104	125	146	211	262	289
	Single phase input	Rated capacity (kVA) (*3)	24	29	40	48	56	81	101	111
		Rated current (A)	24.5	30.0	40.5	48.7	56.9	82.2	102	112
Rated voltage (V) (*4)			Three-phase, 575 to 600 V (with AVR function)							
Overload capability			110%-1 min (Overload interval: Compliant with IEC 61800-2)							
Input power	Three phase input	Main power supply (number of phases, voltage, frequency)	Three-phase, 575 to 600 V, 50/60 Hz							
		Rated current (A) (*5)	57.9	71.0	94.7	113	140	199	249	272
		Required power supply capacity [kVA]	58	71	95	113	140	199	248	271
	Single phase input	Main power supply (number of phases, voltage, frequency)	Single-phase, 575 to 600 V, 50/60 Hz							
		Rated current [A] (*5)	57.9	71.0	94.7	113	140	199	249	272
		Required power supply capacity [kVA]	34	41	55	65	81	115	144	157
	Auxiliary control power supply: (number of phases, voltage, frequency)		Single-phase, 575 to 600 V, 50/60 Hz							
	Auxiliary main power supply (number of phases, voltage, frequency) (*6)		Single-phase, 575 to 600 V, 50/60 Hz							
Voltage, frequency variations		Voltage: +10 to -15% (Interphase voltage unbalance : 2% or less) (*9), Frequency: +5 to -5%								
Braking	Braking torque [%] (*7)		10 to 15							
	DC injection braking		Braking start frequency: 0.0 to 60.0 Hz; Braking time: 0.0 to 30.0 s; Braking operation level: 0 to 60%							
EMC filter (IEC/EN 61800-3) (*8)			EMC standards compliance : Category C3 (emission) / 2nd Env. (Immunity)							
DC reactor (DCR) (*8)			Built-in (IEC/EN 61000-3-2(*10), IEC/EN 61000-3-12)				Standard accessory (IEC/EN 61000-3-12)			
Power factor (at the rated load)	Fundamental wave power factor		> 0.98							
	Total power factor		≥ 0.90							
Efficiency (at the rated load) (%)			98	98	98	98	98	98	98	98
Applicable (safety) standards			UL 508C, C22.2 No. 14, IEC/EN 61800-5-1							
Enclosure	NEMA/UL 50	NEMA/UL Type 1, NEMA/UL Type 12(*11)			UL open type					
Cooling method			Fan cooling							
Weight / Mass [lbs]	NEMA/UL Type 1	110	110	154	154	154				
	NEMA/UL Type 12	110	110	154	154	154				
	UL open type	-					207	216	216	
Environmental Requirements	Site location		Indoors							
	Ambient temperature	UL open type / NEMA/UL Type 1	14 to 122°F							
		NEMA/UL Type 12	14 to 104°F							
	Relative humidity		5 to 95% (No condensation)							
	Atmosphere		The inverter must not be exposed to dust, direct sunlight, corrosive gases, flammable gases, oil mist, vapor or water drops. Pollution degree 2 (IEC/EN 60664-1) (*12) The atmosphere can contain a small amount of salt. (0.01 mg/cm ² or less per year) The inverter must not be subjected to sudden changes in temperature that will cause condensation to form.							
	Altitude		3,300 ft max. (*13)							
	Atmospheric pressure		86 to 106 kPa							
Vibration		3mm 2 to less than 9 Hz 10 m/s ² 9 to less than 200 Hz								

-
- (*1) A box (■) replaces an alphabetic letter depending on the enclosure.
 ■Enclosure: M (NEMA/UL Type1), L (NEMA/UL Type12) or S (UL Open Type)
 - (*2) US 4-pole standard induction motor.
 - (*3) Rated capacity is calculated by assuming the output rated voltage as 575 V.
 - (*4) Output voltage cannot exceed the power supply voltage. At single-phase input use, the output voltage may be lower than three-phase input.
 - (*5) The value is calculated on assumption that the inverter is connected with a power supply 575V, 50Hz and Rsc=120.
 - (*6) The auxiliary power input is used as an AC power input when combining the unit to DC power supply such as high power factor PWM converter with power regenerative function. (Generally not to be used.)
 - (*7) Average braking torque for the motor running alone. (It varies with the efficiency of the motor.) If this value is 2 to 3%, use an optional AC reactor (ACR).
 - (*8) EMC filters and DCR does not conform to each corresponding standards when single phase input use.
 - (*9) Voltage unbalance [%] = (Max. voltage [V] - Min. voltage [V])/Three-phase average voltage [V] x 67 (See IEC/EN 61800-3.)
 If this value is 2 to 3%, use an optional AC reactor (ACR).
 - (*10) It is applicable when the power supply is supplied from 3-phase 200V series transformer which is through 3-phase 400V series transformer.
 - (*11) NEMA/UL Type 12 offers protection for short water jets. Do not use outdoors or in places where long-term waterproofing is required.
 - (*12) Do not install the inverter in an environment where it may be exposed to lint, cotton waste or moist dust or dirt which will clog the heat sink of the inverter. If the inverter is to be used in such an environment, install it in a dustproof panel of your system.
 - (*13) If you use the inverter in an altitude above 3300 ft, you should apply an output current derating factor as listed in the table below.

Altitude	3300 ft or lower	3300 to 4900 ft	4900 to 6600 ft	6600 to 8200 ft	8200 to 9800 ft
Output current derating factor	1.00	0.97	0.95	0.91	0.88

2.2 Common Specifications

Item		Explanation	Remarks
Output frequency	Maximum frequency	25 to 120 Hz variable setting	
	Base frequency	25 to 120 Hz variable setting	
	Starting frequency	0.1 to 60.0 Hz variable setting	
	Carrier frequency	230 V class series: <ul style="list-style-type: none"> • 0.75 to 16 kHz variable setting (1 to 25 HP) • 0.75 to 10 kHz variable setting (30 to 100 HP) • 0.75 to 6 kHz variable setting (125 HP) 460 V class series: <ul style="list-style-type: none"> • 0.75 to 16 kHz variable setting (1 to 50 HP) • 0.75 to 10 kHz variable setting (60 to 125 HP) • 0.75 to 6 kHz variable setting (150 to 900 HP) • 0.75 to 4 kHz variable setting (1000 HP) 575 V class series: <ul style="list-style-type: none"> • 0.75 to 16 kHz variable setting (1 to 50 HP) • 0.75 to 10 kHz variable setting (60 to 125 HP) • 0.75 to 6 kHz variable setting (150 to 300 HP) Note: The carrier frequency may automatically drop depending upon the ambient temperature or the output current to protect the inverter. (The automatic drop function can be disabled.)	
	Output frequency accuracy (Stability)	<ul style="list-style-type: none"> • Analog setting: $\pm 0.2\%$ of maximum frequency (at $25\pm 10^{\circ}\text{C}$ ($77\pm 18^{\circ}\text{F}$)) • Keypad setting: $\pm 0.01\%$ of maximum frequency (at -10 to $+50^{\circ}\text{C}$ (14 to 122°F)) 	
	Frequency setting resolution	<ul style="list-style-type: none"> • Analog setting: 1/3000 of maximum frequency (1/1500 with V2 input) • Keypad setting: 0.01 Hz (99.99 Hz or less), 0.1 Hz (100.0 to 120 Hz) • Link setting: 1/20000 of maximum frequency or 0.01 Hz (fixed) 	
Control method	<ul style="list-style-type: none"> • V/f control • Dynamic torque vector control • V/f control, with slip compensation 		
Control	Voltage/frequency characteristic	230 V class series	<ul style="list-style-type: none"> • Possible to set output voltage at base frequency and at maximum output frequency (80 to 240 V). • The AVR control can be turned ON or OFF. • Non-linear V/f setting (2 points): Free voltage (0 to 240 V) and frequency (0 to 120 Hz) can be set.
		460 V class series	<ul style="list-style-type: none"> • Possible to set output voltage at base frequency and at maximum output frequency (160 to 500 V). • The AVR control can be turned ON or OFF. • Non-linear V/f setting (2 points): Free voltage (0 to 500 V) and frequency (0 to 120 Hz) can be set.
		575 V class series	<ul style="list-style-type: none"> • Possible to set output voltage at base frequency and at maximum output frequency (200 to 600 V). • The AVR control can be turned ON or OFF. • Non-linear V/f setting (2 points): Free voltage (0 to 600 V) and frequency (0 to 120 Hz) can be set.
Torque boost	<ul style="list-style-type: none"> • Auto torque boost (For constant torque load) • Manual torque boost : Torque boost value can be set between 0.0 and 20.0%. • Select application load with the function code. (Variable torque load or constant torque load) 		
Starting torque	<ul style="list-style-type: none"> • 100% or higher, reference frequency 1.0 Hz, base frequency 50 Hz, with slip compensation and auto torque boost active 		
Start/stop operation	Keypad: Start and stop with  /  and  keys		
	External signals (digital inputs): Forward (Reverse) rotation, stop command (capable of 3-wire operation), coast-to-stop command, external alarm, alarm reset, etc.		
	Link operation: Operation through RS-485 or field bus (option) communications		
	Switching a run command: Remote/local switching, link switching		

Item	Explanation	Remarks
Frequency setting	Keypad: Settable with \uparrow and \downarrow keys	"+1 to +5 VDC" can be adjusted with bias and analog input gain.
	External volume: Can be set with external frequency command potentiometer. (1 to 5 k Ω 1/2 W)	
	Analog input: 0 to ± 10 V DC (± 5 V DC) / 0 to $\pm 100\%$ (terminals [12] and [V2]), 0 to +10 V DC (+5 V DC) / 0 to +100% (terminals [12] and [V2]) : +4 to +20 mA DC / 0 to 100% (terminal [C1]) 0 to +20 mA DC / 0 to 100% (terminal [C1])	
	UP/DOWN operation: Frequency can be increased or decreased while the digital input signal is ON.	
	Multistep frequency: Selectable from 16 different frequencies (step 0 to 15)	
	Link operation: Frequency can be specified through RS-485. (Standard setting)	
	Frequency setting: Two types of frequency settings can be switched with an external signal (digital input). Remote/local switching, link switching	
	Auxiliary frequency setting: Inputs at terminal [12], [C1] or [V2] can be added to the main setting as auxiliary frequency settings.	
	Inverse operation : Switchable from "0 to +10 VDC/0 to 100%" to "+10 to 0 VDC/0 to 100%" by external command. : Switchable from "4 to +20 mA DC/0 to 100%" to "+20 to 4 mA DC/0 to 100%" by external command. : Switchable from "0 to +20 mA DC/0 to 100%" to "+20 to 0 mA DC/0 to 100%" by external command.	
	Pattern operation: Up to 7 steps can be specified.	
Control Acceleration/ deceleration time	Setting range: 0.00 to 3600 s	
	Switching: Up to four types of acceleration/deceleration time can be set or selected individually (switchable during running).	
	Acceleration/deceleration pattern: Linear acceleration/deceleration, S-shape acceleration/deceleration (weak, strong), Curvilinear acceleration/deceleration (acceleration/deceleration maximum capacity of constant output)	
	Deceleration mode (coast-to-stop): Turning a run command OFF causes the motor to coast to a stop.	
	Forcible stop deceleration time: Deceleration stop by STOP ("Force to stop").	
Frequency limiter (Upper and lower limit frequencies)	<ul style="list-style-type: none"> Specifies the upper and lower limits in Hz. Possible to choose the processing (Hold the output frequency at the lower limit or Decelerate to a stop) to be applied when the reference frequency drops below the lower limit. Can be set with analog input (terminal [12], [C1], and [V2]). 	
Bias frequency	<ul style="list-style-type: none"> Bias of reference frequency and PID command can be independently specified within the range of 0 to $\pm 100\%$. 	
Analog input	<ul style="list-style-type: none"> Gain : Setting range of 0 to 200% (for each terminal) Offset : Setting range of -5.0 to +5.0% Filter : Setting range of 0.00 to 5.00 s Possible to set the display unit, maximum scale, and minimum scale under PID control. 	
Jump frequency	<ul style="list-style-type: none"> Three operation points and their common jump width (0 to 30.0 Hz) can be set. Six operation points and their common jump width (0 to 30.0 Hz) can be set. (*2) Resonance points can be detected automatically and be set the jump frequency automatically. 	
Auto-restart after momentary power failure	<ul style="list-style-type: none"> Trip at power failure: Trip immediately at power failure. Trip at power recovery: Coast to a stop at power failure and trip at power recovery. Continue to run: Continue to run using the load inertia energy. Start at the frequency applied before momentary power failure: Coast to a stop at power failure and start after power recovery at the frequency applied before momentary stop. Start at starting frequency: Coast to a stop at power failure and start at the starting frequency after power recovery. 	
Hardware current limiter	Limits the current by hardware to prevent an overcurrent trip from being caused by fast load variation or momentary power failure, which cannot be covered by the software current limiter. This limiter can be canceled.	



*2) Available in the ROM version 2400 or later.

Item	Explanation	Remarks
Run by commercial power supply	<ul style="list-style-type: none"> • SW50 ("Switch to commercial power 50 Hz") or SW60 ("Switch to commercial power 60 Hz") switches the inverter to 50 or 60 Hz output, respectively. • Built-in commercial power supply switching sequence 	
Slip compensation	Compensates for decrease in speed according to the load.	
Torque limiter	Switchable between 1st and 2nd torque limit values.	
Software current limiter	Automatically reduces the frequency so that the output current becomes lower than the preset operation level.	
PID control	<ul style="list-style-type: none"> • PID processor for process control • Switchable between forward and reverse operations • Slow flowrate stop function (Pressurized operation is possible before the slow flowrate stop.) • Automatic frequency updating function for slow flowrate stop • PID command: Keypad, analog input (terminals [12], [C1] and [V2]), RS-485 communication, Terminal command UP/DOWN control • PID feedback value (terminals [12], [C1] and [V2]) • Alarm output (absolute value alarm, deviation alarm) • PID feedback error detection • Sensor input amount scaling • Sensor input amount conversion/calculation • PID output limiter • Integration reset/hold • Anti-reset wind-up function • PID auto-tuning function • Application-specific initialization • External PID processor for process control/ On/ Off controller (3 channels) 	
Auto search for idling motor speed	The inverter automatically searches for the idling motor speed to be harmonized and starts to drive it without stopping it. (Motor constants need tuning: Auto-tuning (offline))	
Automatic deceleration control	<ul style="list-style-type: none"> • If the DC link bus voltage or calculated torque exceeds the automatic deceleration level during deceleration, the inverter automatically prolongs the deceleration time to avoid an overvoltage trip. (It is possible to select forcible deceleration to be applied when the deceleration time becomes three times longer.) • If the calculated torque exceeds automatic deceleration level during constant speed operation, the inverter avoids an overvoltage trip by increasing the frequency. • The automatic deceleration level can be specified. 	
Deceleration characteristic (improved braking capacity)	Increases the motor loss during deceleration to reduce the regenerative energy to the inverter to avoid an overvoltage trip.	
Auto energy saving operation	Controls the output voltage to minimize the total sum of the motor loss and inverter loss.	
Overload prevention control	If the ambient temperature or IGBT joint temperature increases due to overload, the inverter lowers the output frequency to avoid overload.	
Voltage Shortage Avoidance Operation	Continues to run by decreasing the output frequency when the input voltage drops.	
Input Phase Loss Protection Avoidance Operation	Selectable from trip or continuous low power operation.	
Auto-tuning (offline)	Tuning the motor while the motor is stopped or running, for setting up motor parameters.	
Cooling fan ON/OFF control	<ul style="list-style-type: none"> • Detects the inverter internal temperature and stops the cooling fan when the temperature is low. • The fan control signal can be output to an external device. 	
Universal DI	Transfers the status of an external digital signal connected to the universal digital input terminal to the host controller.	
Universal DO	Outputs a digital command signal sent from the host controller to the universal digital output terminal.	
Universal AO	Outputs an analog command signal sent from the host controller to the analog output terminal.	

Control

	Item	Explanation	Remarks
Control	Restriction on rotation direction	Reverse or forward rotation prevention.	
	Dew condensation prevention	When the motor is stopped, current is automatically supplied to the motor to keep the motor warm and avoid condensation.	
	Customizable logic interface	2 inputs, 1 output, logical operation, timer function, four arithmetic operations of analog amount, comparison and conversion, choice of maximum/minimum, 14 steps	
	Pump control	<ul style="list-style-type: none"> • Anti-jam function • Filter clogging prevention • Wet-bulb temperature presumption control 	
	Fire mode (Forced operation)	Ignores the inverter alarm and forcibly performs retry operation.	
	Pattern operation	<ul style="list-style-type: none"> • Pattern operation is available by inverter itself. 	
	Real-time clock (RTC)	<ul style="list-style-type: none"> • Displays the current date & time and the alarm info date & time, and enables timer operation. (The RTC can be maintained by an optional battery.) • Has the correction function for daylight saving time (DST). Accuracy of clock is better than ± 30 ppm at 25 °C.	Allows the inverter to keep time.
	Timer operation	<ul style="list-style-type: none"> • 4 timers for operation in a week. • Maximum of 20 pause dates per year. • Capable of running/stopping the inverter or outputting external signals. 	
	Password function	Protects function code data from unintentional change and hides data (at 2 levels).	
Display	Running/Stopping	Speed monitor (reference frequency, output frequency, motor speed, load shaft speed, and speed indication with percent), output current (A), output voltage (V), calculated torque (%), input power (kW), PID command value, PID feedback value, PID output, load factor (%), motor output (kW), analog input, input watt-hour (kWh)/(MWh), and phase effective current (A)	
	Life early warning	<ul style="list-style-type: none"> • Judgment of lifetime of the DC link bus capacitors, capacitors on the printed circuit boards and the cooling fan. • Life early warning can be issued to an external equipment. • Ambient temperature: 40°C (104°F) for UL open type, NEMA/UL Type 1, 30°C (86°F) for NEMA/UL Type 12 (Load factor: Inverter rated current 100%) 	
	Cumulative run time	<ul style="list-style-type: none"> • Display of the inverter cumulative run time, input watt-hour, cumulative motor run time, and the number of startups. • Output of warning when the maintenance time or the number of startups has exceeded the preset values. • Displays the cumulative energy for unit of months, weeks, days and hours and running hours (with RTC). 	
	At the time of a light alarm	The WARN. LED flashes and the light alarm cause displays.	
	At the time of a trip	The ALARM LED flashes and the trip cause displays.	
	During running or at the time of a trip	<ul style="list-style-type: none"> • Trip history: Saves and displays the causes of the latest and last nine trips (with a code). • Light alarm history: Displays the alarm codes of the latest and last five light alarms. • Retry history: Displays alarm codes of two times activation of the protective functions supporting retry. • Saves and displays the detailed running status data of the last four trips. • Saves and displays the date and time at which the inverter tripped when the real-time clock is in operation. 	
	LED indication	LEDs which indicate the running status, light alarm and heavy alarm states.	
	Operation guides	Pressing the HELP key displays the guidance information required at that time.	
	Multilanguage support	English, Chinese, German, French, Spanish, Italian, Russian, Greek, Turkish, Malay, Vietnamese, Thai, Indonesian, Polish, Czech, Swedish, Portuguese, Danish, Dutch, and Japanese	
	Remaining battery charge display	Battery level can be displayed when the battery (option) is connected.	
Backlight	Selectable between "Backlight ON during key operation only" and "Always OFF."		

Item		Explanation	Remarks	
Protection	Overcurrent protection	Protects the inverter from overcurrent caused by overload and stops the inverter.	OC1 OC2 OC3	
	Short-circuit protection	Protects the inverter from overcurrent caused by a short-circuit in the output circuit and stops the inverter.		
	Ground fault protection	Protects the inverter from overcurrent caused by a ground fault in the output circuit and stops the inverter. (For 230 V class series inverters of 25 HP or below, 460 V ones of 50 HP or below and 575 V ones of 50 HP or below) Detects the zero-phase current in the output power, protects the inverter from overcurrent caused by a ground fault in the output circuit, and stops the inverter. (For 230 V class series inverters of 30 HP or above, 460 V ones of 60 HP or above and 575 V ones of 60 HP or above)		EF
	Overvoltage protection	Detects an excessive DC link bus voltage (400 VDC for 230 V class series, 800 VDC for 460 V class series, 1000 VDC for 575 V class series) and stops the inverter. If a strikingly excessive input voltage is applied by mistake, the protection cannot be guaranteed.	OV1 OV2 OV3	
	Undervoltage protection	Detects a DC link bus voltage drop (200 VDC for 230 V class series, 400 VDC for 460 V class series, 600 VDC for 575 V class series) and stops the inverter. Note that no alarm will be issued if "Restart after momentary power failure" is selected.	LV	
	Input phase loss	<ul style="list-style-type: none"> Detects an input phase loss and protects or stops the inverter. When the load is small, a phase loss may not be detected. 	Lin	
	Output phase loss	Detects a break in inverter output wiring during running and stops the inverter output.	OPL	
	Overheat protection		Detects the inverter heat sink temperature in the case of a cooling fan failure or overload and stops the inverter.	OH1
			Detects an internal agitating fan failure and stops the inverter. (For 230 V class series inverters of 7.5 to 25 HP: NEMA/UL TYPE 12 rated ones only, For those of 30 HP or above: All inverter types) (For 460 V class series inverters of 15 to 50 HP: NEMA/UL TYPE 12 rated ones only, For those of 60 HP or above: All inverter types)	FAL
			<ul style="list-style-type: none"> Detects the inner temperature of the inverter unit in the case of a cooling fan failure or overload and stops the inverter. Stop the inverter output detecting the cooling fan failure. Detects a charging circuit error and stops the inverter. 	OH3
	Overload protection	Stops the inverter output upon detection of the abnormal heat sink temperature and switching element temperature calculated with the output current.	OLU	
	External alarm input	The digital input signal THR stops the inverter with an alarm.	OH2	
	Fuse blown	Detects a break of the main circuit fuse in the inverter and stops the inverter. (For 230 V class series inverters of 125 HP, 460 V ones of 150 HP or above, 575 V ones of 200 HP or above)	FUS	
	Charger circuit error	Detects a charger circuit error and stops the inverter. (For 230 V class series inverters of 30 HP or above, 460 V ones of 60 HP or above, 575 V ones of 60 HP or above)	PbF	
	DC fan locked	<ul style="list-style-type: none"> Failure of the air circulation DC fan inside the inverter. For inverters of : 230V series of 75HP or above (UL open type), 30HP or above (NEMA/UL Type 1) and 7.5HP or above (NEMA/UL Type 12) 460V series of 150HP or above (UL open type), 60HP or above (NEMA/UL Type 1) and 15HP or above (NEMA/UL Type 12) 575V series of 200HP or above (UL open type) 60HP or above (NEMA/UL Type 1) and 15HP or above (NEMA/UL Type 12)	FAL	
	Motor protection	Electronic thermal overload protection	Stops the inverter with the electronic thermal overload protection setting to protect the motor. Protects general-purpose motors and inverter motors over all frequency range. (It is possible to set the running level and thermal time constant (0.5 to 75.0 min).)	OL1
		PTC thermistor	Detects the motor temperature to stop the inverter for protecting the motor. Connect a PTC thermistor between terminals [C1] and [11] and configure the switch on the control printed circuit board and function codes.	OH4
		Overload early warning	The inverter outputs a warning signal at the predetermined level before stop.	-
	Memory error	The inverter checks memory data when the power is turned ON or data is written. If any memory error is detected, the inverter stops.	Er1	
Keypad communications error	The error detection function stops the inverter output upon detection of a communications error between the keypad and the inverter control circuit during operation using the keypad.	Er2		
CPU error	If the inverter detects a CPU error or LSI error caused by noise or some other factors, this function stops the inverter output.	Er3		

Item	Explanation	Remarks
Option communications error	Upon detection of an error in communication between the inverter and an option card, this function stops the inverter output.	Er4
Option error	When an option card detects an error, this function stops the inverter output.	Er5
Operation protection	STOP key priority: Pressing the  key on the keypad forcibly decelerates the motor to a stop even when a run command is given via the terminal block or communications link. After the stop, the inverter issues alarm Er6.	Er6
	Start check: To prevent a sudden start, the inverter prohibits any run operations and displays Er6 if any run command is present when; - The inverter power is turned ON, - An alarm is released, or - A run command source is switched via the communications link.	
Tuning error	During tuning of motor parameters, if tuning has failed or aborted, or an abnormal condition has been detected in the tuning result, the inverter stops its output.	Er7
RS-485 communications error (port 1)	When the inverter is connected to a communications network via the RS-485 port designed for the keypad, detecting a communications error stops the inverter output.	Er8
Data save error during undervoltage	If the data could not be saved during activation of the undervoltage protection function, the inverter displays the alarm code.	ErF
RS-485 communications error (port 2)	When the inverter is connected to a communications network via the RS-485 port on the control terminals DX+ and DX-, detecting a communications error stops the inverter output.	ErP
Power supply LSI error	Detects an LSI failure on the power supply printed circuit board, which is mainly caused by noise, and stops the inverter output.	ErH
Mock alarm	A mock alarm can be generated with keypad operations.	Err
Current input wire break detection	If a break of the current input signal wire is detected, this function stops the inverter output (Enable/Disable selectable).	CoF
PID feedback wire break detection	When PID feedback is assigned to the current input, if a wire break is detected, this function stops the inverter output. (Switchable between Enable and Disable)	PV1 PV2 PVA PVb PVC
Enable circuit failure	Diagnoses the Enable circuit. If any circuit failure is detected, this function stops the inverter output.	ECF
Customizable logic abnormality	Issues an alarm if a customizable logic configuration error is detected.	ECL
Anti-jam function	Displays an error if starting has failed due to overcurrent.	rLo
Filter clogging prevention	Displays an error if overload is detected under PID control.	FoL
Password protection	Entering a wrong password five times causes an alarm.	LoK
Fire mode	Displays an alarm during running in fire mode (without stopping due to alarm).	Fod
Alarm relay output (for any fault)	<ul style="list-style-type: none"> • Outputs a relay contact signal if the inverter issues an alarm and stops its output. •  key or digital input signal RST resets the alarm stop state. 	
Light alarm (warning)	<p>Upon detection of a failure or warning status that has been defined as a light alarm item, the inverter displays a light alarm without stopping running.</p> <p><u>Light alarm objects</u></p> <p>External alarm (OH2), Inverter internal overheat (OH3), Motor overload (OL1), Option communications error (Er4), Option error (Er5), RS-485 communications error (COM port 1) (Er8), RS-485 communications error (COM port 2) (ErP), Current input wire break detection (CoF), PID control 1, 2 feedback error detection (PV1, PV2), External PID control 1, 2, 3 feedback error detection (PVA, PVb, PVC), Filter clogging error (FoL), DC fan locked (FAL), Motor overload early warning (OL), Heat sink overheat early warning (OH), Lifetime alarm (DC link bus capacitor, electrolytic capacitors on printed circuit boards or cooling fans) (Lif), Reference command loss detected (rEF), Low torque output (UTL), PTC thermistor activated (PTC), Inverter life (cumulative run time) (rTE), Inverter life (number of startups) (CnT), PID control 1, 2 alarm (PA1, PA2), External PID control 1, 2, 3 alarm (PAA, PAb, PAC), Mutual operation slave alarm (SLA), Low battery warning (Lob), Date & time information lost (dtL)</p>	

Protection

Item	Explanation		Remarks
Stall prevention	When the output current exceeds the current limiter level during acceleration/deceleration or running at constant speed, this function decreases the output frequency to avoid an overcurrent trip.		
Retry function	When the inverter has stopped because of a trip, this function allows the inverter to automatically reset itself and restart. (It is possible to specify the number of retries, the latency between stop and reset, and target protective functions for retries.) It is also possible to know how many times retry has been attempted so far via the communications link. Target protective functions: Overcurrent protection (OC1 to OC3), Overvoltage protection (OV1 to OV3), Overheat protection (OH1, OH3), Inverter overload (OLU), Motor 1 overload (OL1), Motor overload (OH4), External alarm (OH2), Undervoltage protection (LV)		
Surge protection	Protects the inverter against surge voltages which might appear between one of the power lines for the main circuit and the ground.		
Command loss detection	Upon detection of a loss of a frequency command (because of a wire break, etc.), this function issues an alarm and continues the inverter operation at the preset reference frequency (specified as a ratio to the frequency just before the detection).		
Momentary power failure protection	If restart after momentary power failure is selected, this function invokes a restart process when power has been restored within a predetermined period (allowable momentary power failure time).		
Installation location	Shall be free from corrosive gases, flammable gases, oil mist, dusts, and direct sunlight. (Pollution degree 2 (IEC/EN 60664-1)). Indoor use only.		
Ambient temperature	NEMA/UL TYPE1	-10 to +50°C (14 to 122°F) (+50 to +60°C (122 to 140°F) covered by derating) -10 to +40°C (14 to 104°F) for inverters mounted closely side by side (230 V class series of 25 HP or below, 460 V ones of 50 HP or below and 575 V ones of 50 HP or below)	
	NEMA/UL TYPE12	-10 to +40°C (14 to 104°F) (+40 to +50°C (104 to 122°F) covered by derating) -10 to +30°C (14 to 86°F) for inverters mounted closely side by side (230 V class series of 25 HP or below, 460 V ones of 50 HP or below and 575 V ones of 50 HP or below)	
	UL open type	-10 to +50°C (14 to 122°F)	
Relative humidity	5 to 95% RH (without condensation)		
Altitude	Lower than 1,000 m (3300 ft)		
Environment	Vibration	230 V class series inverters of 60 HP or below, 460 V ones of 125 HP or below and 575 V ones of 150 HP or below 3 mm: 2 to less than 9 Hz 10 m/s ² : 9 to less than 200 Hz	
		230 V class series inverters of 75 HP and 100 HP 3 mm: 2 to less than 9 Hz 9.8 m/s ² : 9 to less than 20 Hz 2 m/s ² : 20 to less than 55 Hz 1 m/s ² : 55 to less than 200 Hz	
		230 V class series inverters of 125 HP, 460 V ones of 150 HP to 1000 HP 575V class series inverters of 200 HP to 300 HP 3 mm: 2 to less than 9 Hz 2 m/s ² : 9 to less than 55 Hz 1 m/s ² : 55 to less than 200 Hz	
Storage temperature	-25 to +70°C (-13 to 158°F)		
Storage humidity	5 to 95% RH (without condensation)		

2.3 Terminal Specifications

2.3.1 Terminal functions

Main circuit and analog input terminals

Classification	Symbol	Name	Functions
Main circuit	L1/R, L2/S, L3/T	Main circuit power inputs	Connect the three-phase input power lines.
	U, V, W	Inverter outputs	Connect a three-phase motor.
	R0, T0	Auxiliary power input for the control circuit	For a backup of the control circuit power supply, connect AC power lines same as that of the main power input.
	P1, P(+)	DC reactor	Connect a DC reactor (DCR) for power factor correction. (For 230 V class series inverters of 75 HP or above and 460 V ones of 150 HP or above and 575 V ones of 150 HP or above)
	P(+), N(-)	DC link bus	To be used for connecting a DC link bus. For use of these terminals, consult your Fuji Electric representative.
	R1, T1	Auxiliary main circuit power supply	Usually there is no need to do anything for these terminals. To be used when the inverter is combined with a PWM converter. (For 230 V class series inverters of 30 HP or above, 460 V ones of 60 HP or above and 575 V ones of 60 HP or above)
	 G	Grounding for inverter and motor	Grounding terminals for the inverter's chassis (or case) and motor. Be sure to ground these terminals for safety and electric noise reduction.
	E1, E2	Grounding for EMC filter	Usually there is no need to do anything for the EMC filter. When the leakage current from the connected EMC filter causes problems with the power supply system, removing screws from terminals [E1] and [E2] could improve the problem. Note that doing so loses the effect of the EMC filter so that the inverter is no longer compliant with the EMC standards. To remove those screws, consult your Fuji Electric representative. (For 230 V class series inverters of 60 HP or below, 460 V ones of 125 HP or below and 575 V ones of 50 HP or below)
Analog input	[13]	Power supply for the potentiometer	Power supply (+10 VDC) for frequency command potentiometer (Potentiometer: 1 to 5kΩ) The potentiometer of 1/2 W rating or more should be connected.
	[12]	Analog setting voltage input	(1) The frequency is commanded according to the external analog voltage input. <ul style="list-style-type: none"> • 0 to ±10 VDC/0 to ±100% (Normal operation) • +10 to 0 VDC/0 to 100% (Inverse operation) (2) In addition to frequency setting, PID command, PID feedback signal, auxiliary frequency command setting, ratio setting, upper/lower frequency limits, or analog input monitor can be assigned to this terminal. (3) Hardware specifications <ul style="list-style-type: none"> • Input impedance: 22kΩ • The maximum input is ±15 VDC, however, the voltage exceeding ±10 VDC is handled as ±10 VDC. • Inputting a bipolar analog voltage (0 to ±10 VDC) to terminal [12] requires setting function code C35 to "0."

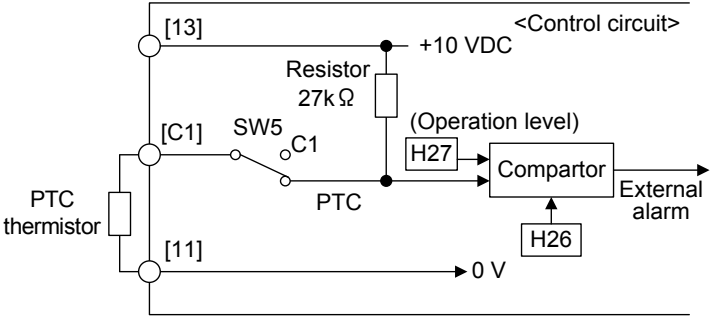
Classification	Symbol	Name	Functions
Analog input	[C1]	Analog setting current input (C1 function)	<p>(1) The frequency is commanded according to the external analog current input.</p> <ul style="list-style-type: none"> • 4 to 20 mA DC/0 to 100% (Normal operation) • 0 to 20 mA DC/0 to 100% (Normal operation) • 20 to 4 mA DC/0 to 100 % (Inverse operation) • 20 to 0 mA DC/0 to 100 % (Inverse operation) <p>(2) In addition to frequency setting, PID command, PID feedback signal, auxiliary frequency command setting, ratio setting, upper/lower frequency limits, or analog input monitor can be assigned to this terminal.</p> <p>(3) Hardware specifications</p> <ul style="list-style-type: none"> • Input impedance: 250Ω • The maximum input is +30 mA DC, however, the current exceeding +20 mA DC is handled as +20 mA DC.
		PTC thermistor input (PTC function)	<p>(1) Connects PTC (Positive Temperature Coefficient) thermistor for motor protection. Ensure that the slide switch SW5 on the control PCB is turned to the PTC position (refer to Section 2.3.2 "Setting up the slide switches").</p> <p>The figure shown below illustrates the internal circuit diagram where SW5 (switching the input of terminal [C1] between C1 and PTC) is turned to the PTC position. For details on SW5, refer to Section 2.3.2 "Setting up the slide switches." In this case, you must change data of the function code H26 accordingly.</p>  <p style="text-align: center;">Figure 2.1 Internal Circuit Diagram (SW5 Selecting PTC)</p>
	[V2]	Analog setting voltage input (V2 function)	<p>(1) The frequency is commanded according to the external analog voltage input.</p> <ul style="list-style-type: none"> • 0 to ±10 VDC/0 to ±100 % (Normal operation) • +10 to 0 VDC/0 to 100% (Inverse operation) <p>(2) In addition to frequency setting, PID command, PID feedback signal, auxiliary frequency command setting, ratio setting, upper/lower frequency limits, or analog input monitor can be assigned to this terminal.</p> <p>(3) Hardware specifications</p> <ul style="list-style-type: none"> • Input impedance: 22kΩ • The maximum input is ±15 VDC, however, the voltage exceeding ±10 VDC is handled as ±10 VDC. • Inputting a bipolar analog voltage (0 to ±10 VDC) to terminal [V2] requires setting function code C45 to "0."
[11]	Analog common	<p>Common for analog input/output signals ([13], [12], [C1], [V2], [FM1] and [FM2]).</p> <p>Isolated from terminals [CM]s and [CMY].</p>	

Classification	Symbol	Name	Functions	Related function codes
Analog input	<p>Note</p> <ul style="list-style-type: none"> - Since low level analog signals are handled, these signals are especially susceptible to the external noise effects. Route the wiring as short as possible (within 20 m (66 ft)) and use shielded wires. In principle, ground the shielded sheath of wires; if effects of external inductive noises are considerable, connection to terminal [11] may be effective. As shown in Figure 2.2, be sure to ground the single end of the shield to enhance the shield effect. - Use a twin-contact relay for low level signals if the relay is used in the control circuit. Do not connect the relay's contact to terminal [11]. - When the inverter is connected to an external device outputting the analog signal, the external device may malfunction due to electric noise generated by the inverter. If this happens, according to the circumstances, connect a ferrite core (a toroidal core or equivalent) to the device outputting the analog signal or connect a capacitor having the good cut-off characteristics for high frequency between control signal wires as shown in Figure 2.3. - Do not apply a voltage of +7.5 VDC or higher to terminal [C1]. Doing so could damage the internal control circuit. 			
	<p>Figure 2.2 Connection of Shielded Wire</p>	<p>Figure 2.3 Example of Electric Noise Reduction</p>		

Digital Input Terminals



Classification	Symbol	Name	Functions
Digital input	[X1]	Digital input 1	(1) Various signals such as "Coast to a stop," "Enable external alarm trip," and "Select multistep frequency" can be assigned to terminals [X1] to [X7], [FWD] and [REV] by setting function codes E01 to E07, E98, and E99. For details, refer to Chapter 6 "FUNCTION CODES." (2) Input mode, i.e. SINK/SOURCE, is changeable by using the slide switch SW1. (Refer to Section 2.3.2 "Setting up the slide switches.") (3) Switches the logic value (1/0) for ON/OFF of the terminals [X1] to [X7], [FWD], or [REV]. If the logic value for ON of the terminal [X1] is "1" in the normal logic system, for example, OFF is "1" in the negative logic system and vice versa. (Digital input circuit specifications)
	[X2]	Digital input 2	
	[X3]	Digital input 3	
	[X4]	Digital input 4	
	[X5]	Digital input 5	
	[X6]	Digital input 6	
	[X7]	Digital input 7	
	[FWD]	Run forward command	
	[REV]	Run reverse command	

The diagram shows a control circuit for digital inputs. It features a +24 VDC power source connected to a PLC terminal. A slide switch SW1 is used to select between SINK and SOURCE input modes. The circuit includes a photocoupler for isolation, a 5.4kΩ resistor, and a 1.6kΩ resistor for terminal [X7]. The input terminals are labeled [X1] to [X7], [FWD], [REV], and [CM].

Figure 2.4 Digital Input Circuit (a)

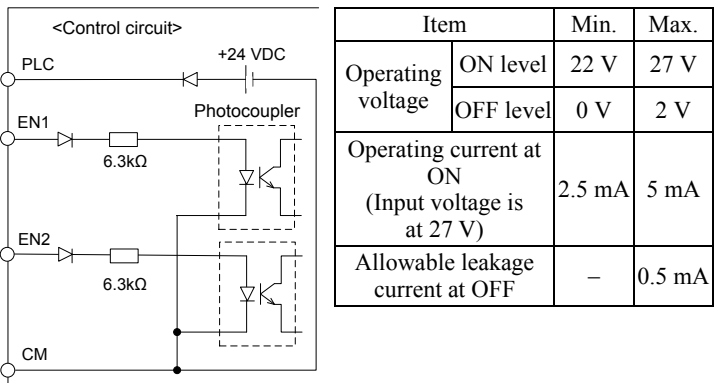
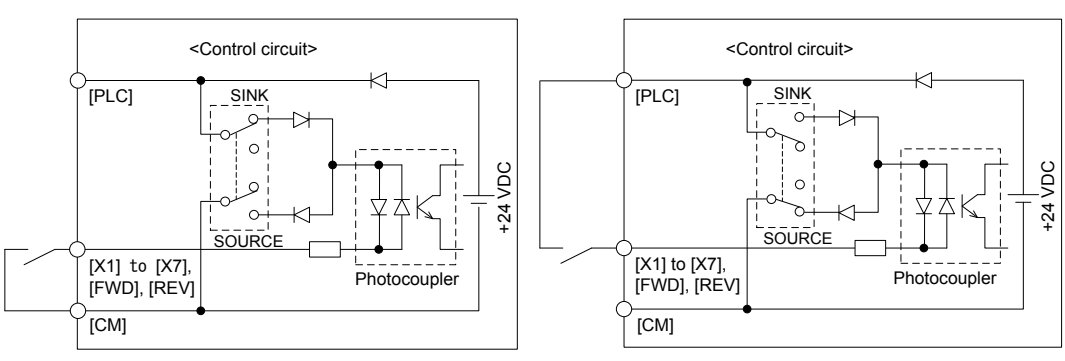
Item	Min.	Max.
Operating voltage (SINK)	ON level	0 V
	OFF level	22 V
Operating voltage (SOURCE)	ON level	22 V
	OFF level	0 V
Operating current at ON (Input voltage is at 0 V) (For [X7])	2.5 mA	5 mA
	(9.7 mA)	(16 mA)
Allowable leakage current at OFF	–	0.5 mA

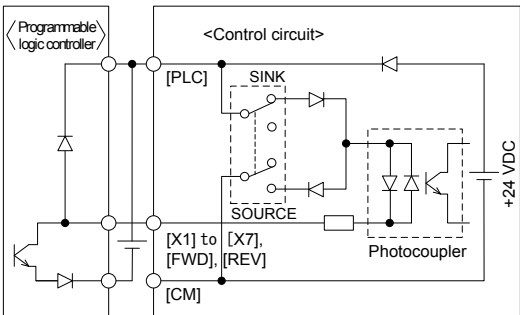
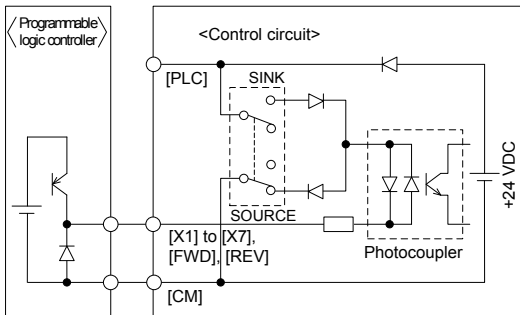
Classification	Symbol	Name	Functions																
Digital input	[EN1]	Enable input 1	<p>(1) Opening terminals [EN1] and [PLC] or terminals [EN2] and [PLC] stops the inverter's output transistor. (Safe Torque Off, STO)</p> <p>(2) These terminals are exclusively used for the SOURCE mode input and cannot be switched to the SINK mode input.</p> <p>(3) If input to either one of [EN1] and [EN2] is OFF, the inverter issues an alarm (ECF). If the duration exceeds 50 ms, it is regarded as mismatch. This alarm can be reset only by restarting the inverter.</p> <p>(Digital input circuit specifications)</p>  <table border="1" data-bbox="1005 604 1388 907"> <thead> <tr> <th>Item</th> <th>Min.</th> <th>Max.</th> </tr> </thead> <tbody> <tr> <td rowspan="2">Operating voltage</td> <td>ON level</td> <td>22 V</td> <td>27 V</td> </tr> <tr> <td>OFF level</td> <td>0 V</td> <td>2 V</td> </tr> <tr> <td>Operating current at ON (Input voltage is at 27 V)</td> <td>2.5 mA</td> <td>5 mA</td> </tr> <tr> <td>Allowable leakage current at OFF</td> <td>-</td> <td>0.5 mA</td> </tr> </tbody> </table> <p>Figure 2.5 Digital Input Circuit (b)</p>	Item	Min.	Max.	Operating voltage	ON level	22 V	27 V	OFF level	0 V	2 V	Operating current at ON (Input voltage is at 27 V)	2.5 mA	5 mA	Allowable leakage current at OFF	-	0.5 mA
	Item	Min.		Max.															
	Operating voltage	ON level		22 V	27 V														
OFF level		0 V	2 V																
Operating current at ON (Input voltage is at 27 V)	2.5 mA	5 mA																	
Allowable leakage current at OFF	-	0.5 mA																	
[EN2]	Enable input 2																		
[PLC]	Power for programmable logic controller signals	<p>(1) Connects to PLC output signal power supply. Rated voltage: +24 VDC (Allowable range: +22 to +27 VDC), Maximum 200 mA DC</p> <p>(2) This terminal also supplies a power to the load connected to the transistor output terminals [Y1] and [Y2]. Refer to "Transistor output" described later in this table for more.</p>																	
[CM]	Digital input common	Two common terminals for digital input signals These terminals are electrically isolated from the terminals [11]s and [CMY].																	
<p>Tip ■ Using a relay contact to turn [X1] to [X7], [FWD] or [REV] ON or OFF</p> <p>Figure 2.6 shows two examples of a circuit that uses a relay contact to turn control signal input [X1] to [X7], [FWD], or [REV] ON or OFF. In circuit (a), the slide switch SW1 is turned to SINK, whereas in circuit (b) it is turned to SOURCE.</p> <p>Note: To configure this kind of circuit, use a highly reliable relay. (Recommended product: Fuji control relay Model HH54PW.)</p>  <p>(a) With the switch turned to SINK</p> <p>(b) With the switch turned to SOURCE</p> <p>Figure 2.6 Circuit Configuration Using a Relay Contact</p>																			

Classifi- cation	Symbol	Name	Functions
Digital input	<p> Tip</p>	<p>■ Using a programmable logic controller (PLC) to turn [X1] to [X7], [FWD], or [REV] ON or OFF</p>	<p>Figure 2.7 shows two examples of a circuit that uses a programmable logic controller (PLC) to turn control signal input [X1] to [X7], [FWD], or [REV] ON or OFF. In circuit (a), the slide switch SW1 is turned to SINK, whereas in circuit (b) it is turned to SOURCE.</p> <p>In circuit (a) below, short-circuiting or opening the transistor's open collector circuit in the PLC using an external power supply turns ON or OFF control signal [X1] to [X7], [FWD], or [REV]. When using this type of circuit, observe the following:</p> <ul style="list-style-type: none"> - Connect the + node of the external power supply (which should be isolated from the PLC's power) to terminal [PLC] of the inverter. - Do not connect terminal [CM] of the inverter to the common terminal of the PLC.
			<p>(a) With the switch turned to SINK</p> <p>(b) With the switch turned to SOURCE</p>
<p>Figure 2.7 Circuit Configuration Using a PLC</p>			<p> For details about the slide switch setting, refer to Section 2.3.2 "Setting up the slide switches.")</p>

Analog output, transistor output, and relay output terminals

Classification	Symbol	Name	Functions																							
Analog output	[FM1] [FM2]	Analog monitor	<p>These terminals output monitor signals of analog DC voltage (0 to +10 V) or analog DC current (+4 to +20 mA DC or 0 to +20 mA DC).</p> <p>The output form (VO/IO) for [FM1] or [FM2] can be switched by the slide switch (SW4/SW6) on the control PCB and the function code F29/F32, as listed below.</p> <table border="1"> <thead> <tr> <th rowspan="2">Terminal</th> <th rowspan="2">Function</th> <th colspan="2">Output form</th> <th rowspan="2">Signal function specified by</th> </tr> <tr> <th>DC voltage</th> <th>DC current</th> </tr> </thead> <tbody> <tr> <td rowspan="2">FM1</td> <td>SW4</td> <td>VO1</td> <td>IO1</td> <td rowspan="2">F31 data</td> </tr> <tr> <td>F29</td> <td>0</td> <td>1</td> </tr> <tr> <td rowspan="2">FM2</td> <td>SW6</td> <td>VO2</td> <td>IO2</td> <td rowspan="2">F35 data</td> </tr> <tr> <td>F32</td> <td>0</td> <td>1</td> </tr> </tbody> </table> <p>The signal function can be selected from the following with function code F31/F35.</p> <ul style="list-style-type: none"> • Output frequency • Output torque • PID feedback amount • Universal AO • Calibration • PID deviation • Customizable logic output signal • Inverter heat sink temperature • Reference frequency, etc. • Output current • Load factor • DC link bus voltage • Motor output • PID command • Reference frequency • Output voltage • Input power • PID output <p>For details, refer to Chapter 6 "FUNCTION CODES."</p> <ul style="list-style-type: none"> - Input impedance of external device: Min. 5kΩ (at 0 to 10 VDC output) (While the terminal is outputting 0 to 10 VDC, it is capable of driving up to two analog voltmeters with 10 kΩ impedance.) - Input impedance of external device: Max. 500Ω (at 4 to 20 mA DC output) - Adjustable range of the gain: 0 to 300% 	Terminal	Function	Output form		Signal function specified by	DC voltage	DC current	FM1	SW4	VO1	IO1	F31 data	F29	0	1	FM2	SW6	VO2	IO2	F35 data	F32	0	1
	Terminal	Function	Output form			Signal function specified by																				
DC voltage			DC current																							
FM1	SW4	VO1	IO1	F31 data																						
	F29	0	1																							
FM2	SW6	VO2	IO2	F35 data																						
	F32	0	1																							
	[11]	Analog common	<p>Two common terminals for analog input and output signals. These terminals are electrically isolated from terminals [CM]s and [CMY].</p>																							

Classification	Symbol	Name	Functions														
Transistor output	[Y1]	Transistor output 1	<p>(1) Various signals such as inverter running, frequency arrival and overload early warning can be assigned to terminals [Y1] to [Y4] by setting function code E20 to E23. Refer to Chapter 6 "FUNCTION CODES" for details.</p> <p>(2) It is possible to switch the logic value (1/0) for ON/OFF of the terminals between [Y1] to [Y4], and [CMY]. If the logic value for ON between [Y1] to [Y4] and [CMY] is 1 in the normal logic system, for example, OFF is 1 in the negative logic system and vice versa.</p> <p>(Transistor output circuit specifications)</p>  <p style="text-align: center;">Figure 2.8 Transistor Output Circuit</p> <table border="1" data-bbox="790 1097 1244 1422"> <thead> <tr> <th colspan="2">Item</th> <th>Max.</th> </tr> </thead> <tbody> <tr> <td rowspan="2">Operation voltage</td> <td>ON level</td> <td>2 V</td> </tr> <tr> <td>OFF level</td> <td>27 V</td> </tr> <tr> <td colspan="2">Maximum motor current at ON</td> <td>50 mA</td> </tr> <tr> <td colspan="2">Leakage current at OFF</td> <td>0.1 mA</td> </tr> </tbody> </table>	Item		Max.	Operation voltage	ON level	2 V	OFF level	27 V	Maximum motor current at ON		50 mA	Leakage current at OFF		0.1 mA
	Item			Max.													
	Operation voltage	ON level		2 V													
		OFF level		27 V													
	Maximum motor current at ON		50 mA														
Leakage current at OFF		0.1 mA															
[Y2]	Transistor output 2																
[Y3]	Transistor output 3																
[Y4]	Transistor output 4																
[CMY]	Transistor output common	<p>Common terminal for transistor output signals</p> <p>This terminal is electrically isolated from terminals [CM]s and [I1]s.</p>															

Figure 2.9 shows examples of connection between the control circuit and a PLC.

- Note**
- When a transistor output drives a control relay, connect a surge-absorbing diode across relay's coil terminals.
 - When any equipment or device connected to the transistor output needs to be supplied with DC power, feed the power (+24 VDC: allowable range: +22 to +27 VDC, 200 mA max.) through the [PLC] terminal. Short-circuit between terminals [CMY] and [CM] in this case.

Classification	Symbol	Name	Functions	Related function codes
Transistor output	<p>Tip</p> <p>■ Connecting programmable logic controller (PLC) to terminal [Y1], [Y2], [Y3] or [Y4]</p> <p>Figure 2.9 shows two examples of circuit connection between the transistor output of the inverter's control circuit and a PLC. In example (a), the input circuit of the PLC serves as a SINK for the control circuit output, whereas in example (b), it serves as a SOURCE for the output.</p>		 <p>(a) PLC serving as SINK</p> <p>(b) PLC serving as SOURCE</p>	
	<p>Figure 2.9 Connecting PLC to Control Circuit</p>			
Relay output	[Y5A/C]	General-purpose relay output	<p>(1) A general-purpose relay contact output usable as well as the function of the transistor output terminal [Y1], [Y2], [Y3] or [Y4].</p> <p>Contact rating: $250 \text{ VAC}, 0.3 \text{ A}, \cos \phi = 0.3$, $48 \text{ VDC}, 0.5 \text{ A}$</p> <p>(2) Switching of the normal/negative logic output is applicable to the following two contact output modes: "Active ON" (Terminals [Y5A] and [Y5C] are closed (excited) if the signal is active.) and "Active OFF" (Terminals [Y5A] and [Y5C] are opened (non-excited) if the signal is active while they are normally closed.).</p>	
	[30A/B/C]	Alarm relay output (for any error)	<p>(1) Outputs a contact signal (1C) when the protective function has been activated to stop the motor.</p> <p>Contact rating: $250 \text{ VAC}, 0.3 \text{ A}, \cos \phi = 0.3$, $48 \text{ VDC}, 0.5 \text{ A}$</p> <p>(2) Any one of output signals assigned to terminals [Y1] to [Y4] can also be assigned to this relay contact to use it for signal output.</p> <p>(3) Switching of the normal/negative logic output is applicable to the following two contact output modes: "Active ON" (Terminals [30A] and [30C] are closed (excited) if the signal is active.) and "Active OFF" (Terminals [30A] and [30C] are opened (non-excited) if the signal is active while they are normally closed.).</p>	

RS-485 communications port

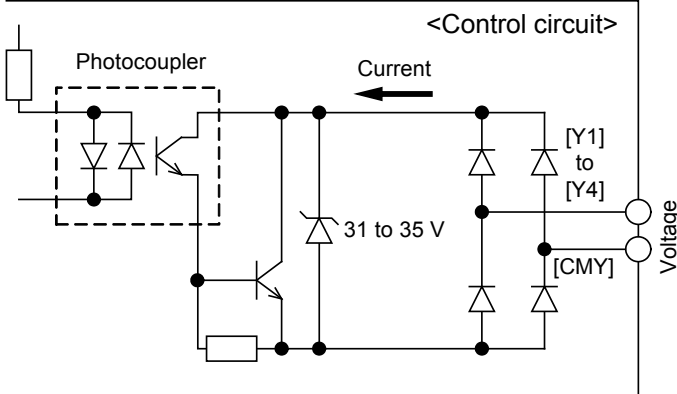
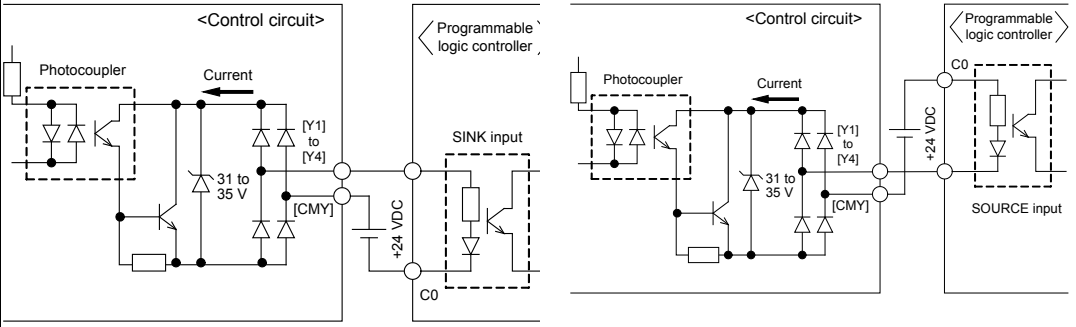
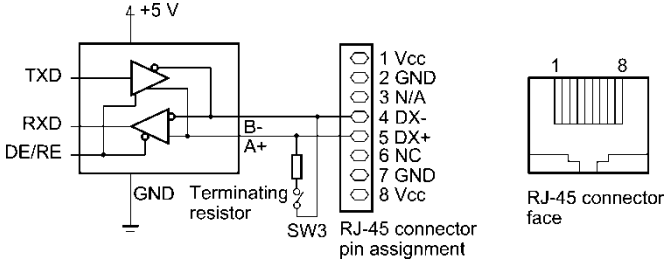
Classification	Connector	Name	Functions
Communication	DX+/DX-/SD	RS-485 communications port 2 (Terminal block)	The communications port transmits data through the RS-485 multipoint protocol between the inverter and a computer or other equipment such as a PLC (Programmable Logic Controller). (For setting of the terminating resistor, refer to Section 2.3.2 "Setting up the slide switches.")
	RJ-45 connector for keypad connection	RS-485 communications port 1 (Standard RJ-45 connector)	<p>(1) Used to connect the inverter with the keypad. The inverter supplies the power to the keypad through the pins specified below. The extension cable for remote operation also uses wires connected to these pins for supplying the keypad power.</p> <p>(2) Remove the keypad from the standard RJ-45 connector and connect the RS-485 communications cable to control the inverter through the PC or PLC (Programmable Logic Controller). For setting of the terminating resistor, refer to Section 2.3.2 "Setting up the slide switches."</p>  <p>Figure 2.10 RJ-45 Connector and its Pin Assignment*</p> <p>* Pins 1, 2, 7, and 8 are exclusively assigned to power lines for the keypad, so do not use those pins for any other equipment.</p>
	CN10	USB port	A USB port connector (mini B) that connects an inverter to a computer. FRENIC Loader running on the computer supports editing the function codes, transferring them to the inverter, verifying them, test-running an inverter and monitoring the inverter running status.
Battery	CN11	Connector for battery	A connector for an optional battery.



- Route the wiring of the control circuit terminals as far from the wiring of the main circuit as possible. Otherwise electric noise may cause malfunctions.
- Fix the control circuit wires with a cable tie inside the inverter to keep them away from the live parts of the main circuit (such as the terminal block of the main circuit).

2.3.2 Setting up the slide switches

⚠ WARNING

Before changing the switches, turn OFF the power and wait at least ten minutes. Make sure that the LCD monitor is turned OFF. Further, make sure, using a multimeter or a similar instrument, that the DC link bus voltage between the terminals P(+) and N(-) has dropped to the safe level (+25 VDC or below).

An electric shock may result if this warning is not heeded as there may be some residual electric charge in the DC bus capacitor even after the power has been turned OFF.

Switching the slide switches located on the control PCB allows you to customize the operation mode of the analog output terminals, digital I/O terminals, and communications ports. The locations of those switches are shown in Figure 2.11.

To access the slide switches, remove the front cover so that you can see the control PCB.

Table 2.1 lists the function of each slide switch.

Table 2.1 Function of Each Slide Switch

Slide Switch	Function																			
SW1	Switches the service mode of the digital input terminals between SINK and SOURCE. - This switches the input mode of digital input terminals [X1] to [X7], [FWD] and [REV] to be used as the SINK or SOURCE mode. - Factory default: SINK																			
SW2	Switches the terminating resistor of RS-485 communications port on the inverter ON and OFF. (RS-485 communications port 2, on the terminal block) - If the inverter is connected to the RS-485 communications network as a terminating device, turn SW2 to ON.																			
SW3	Switches the terminating resistor of RS-485 communications port on the inverter ON and OFF. (RS-485 communications port 1, for connecting the keypad) - To connect a keypad to the inverter, turn SW3 to OFF (Factory default). - If the inverter is connected to the RS-485 communications network as a terminating device, turn SW3 to ON.																			
SW4/SW6	Switches the output mode of the analog output terminal [FM1]/[FM2] between voltage and current. When changing this switch setting, also change the data of function code F29/F32. <table border="1" style="margin-left: 20px;"> <thead> <tr> <th rowspan="2">Output mode</th> <th colspan="2">[FM1]</th> <th colspan="2">[FM2]</th> </tr> <tr> <th>SW4</th> <th>F29 data</th> <th>SW6</th> <th>F32 data</th> </tr> </thead> <tbody> <tr> <td>Voltage output (Factory default)</td> <td>VO1</td> <td>0</td> <td>VO2</td> <td>0</td> </tr> <tr> <td>Current output</td> <td>IO1</td> <td>1, 2</td> <td>IO2</td> <td>1, 2</td> </tr> </tbody> </table>	Output mode	[FM1]		[FM2]		SW4	F29 data	SW6	F32 data	Voltage output (Factory default)	VO1	0	VO2	0	Current output	IO1	1, 2	IO2	1, 2
Output mode	[FM1]		[FM2]																	
	SW4	F29 data	SW6	F32 data																
Voltage output (Factory default)	VO1	0	VO2	0																
Current output	IO1	1, 2	IO2	1, 2																
SW5	Switches the property of the analog input terminal [C1] between analog setting current input and PTC thermistor input. When changing this switch setting, also change the data of function code H26. <table border="1" style="margin-left: 20px;"> <thead> <tr> <th>Output mode</th> <th>SW5</th> <th>H26 data</th> </tr> </thead> <tbody> <tr> <td>Analog setting current input (Factory default)</td> <td>C1</td> <td>0</td> </tr> <tr> <td>PTC thermistor input</td> <td>PTC</td> <td>1 (alarm) or 2 (warning)</td> </tr> </tbody> </table>	Output mode	SW5	H26 data	Analog setting current input (Factory default)	C1	0	PTC thermistor input	PTC	1 (alarm) or 2 (warning)										
Output mode	SW5	H26 data																		
Analog setting current input (Factory default)	C1	0																		
PTC thermistor input	PTC	1 (alarm) or 2 (warning)																		

Figure 2.11 shows the location of slide switches on the control PCB.

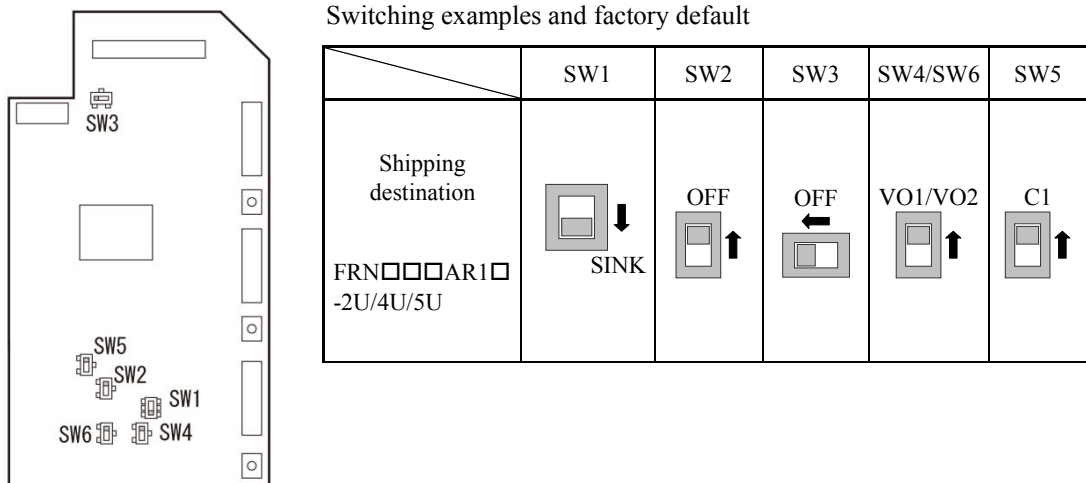

Figure 2.11 Location of the Slide Switches on the Control PCB

Note To move a switch slider, use a tool with a narrow tip (e.g., tweezers), taking care not to touch other electronic parts on the PCB. If the slider is in an ambiguous position, the circuit is unclear whether it is turned ON or OFF and the input remains in an undefined state. Be sure to place the slider so that it contacts either side of the switch.

Slider in the correct position	or
Slider in an ambiguous position	

2.3.3 Screw specifications and recommended wire sizes

2.3.3.1 Main circuit terminals

The specifications of the screws to use for the wiring of the main circuit are shown below. Please note that terminal arrangements vary depending on inverter capacities.

Refer to 「Chapter 11 CONFORMITY WITH STANDARDS」 for recommended wire size.

Use crimp terminals covered with an insulation sheath or with an insulation tube.

■ Screw Specifications (230 V class series)

Power supply voltage	Nominal applied motor (HP)	Inverter type	Refer to:	Main circuit terminals		Grounding terminals		Aux. control power supply Aux. main circuit power supply	
				Screw size	Tightening torque (lb-in)	Screw size	Tightening torque (lb-in)	Screw size	Tightening torque (lb-in)
Three-phase 230V	1	FRN001AR1■-2U	Figure A	M4	15.9	M4	15.9	M3.5	10.6
	2	FRN002AR1■-2U							
	3	FRN003AR1■-2U							
	5	FRN005AR1■-2U							
	7.5	FRN007AR1■-2U	Figure B	M6	51.3	M6	51.3		
	10	FRN010AR1■-2U							
	15	FRN015AR1■-2U							
	20	FRN020AR1■-2U	Figure C	M8	119.4	M8	119.4		
	25	FRN025AR1■-2U							
	30	FRN030AR1■-2U	Figure D	M10	238.9	M10	238.9		
	40	FRN040AR1■-2U	Figure E			M8	119.4		
	50	FRN050AR1■-2U	Figure F						
	60	FRN060AR1■-2U							
	75	FRN075AR1S-2U	Figure L	M12	424.7	M10	238.9		
100	FRN100AR1S-2U								
125	FRN125AR1S-2U								

Note: A box (■) replaces an alphabetic letter depending on the enclosure.
M (NEMA/UL TYPE 1) or L (NEMA/UL TYPE 12)

■ Screw Specifications (460 V class series)

Power supply voltage	Nominal applied motor (HP)	Inverter type	Refer to:	Main circuit terminals		Grounding terminals		Aux. control power supply Aux. main circuit power supply	
				Screw size	Tightening torque (lb-in)	Screw size	Tightening torque (lb-in)	Screw size	Tightening torque (lb-in)
Three-phase 460V	1	FRN001AR1■-4U	Figure A	M4	15.9	M4	15.9	M3.5	10.6
	2	FRN002AR1■-4U							
	3	FRN003AR1■-4U							
	5	FRN005AR1■-4U							
	7.5	FRN007AR1■-4U							
	10	FRN010AR1■-4U	Figure B	M6	51.3	M6	51.3		
	15	FRN015AR1■-4U							
	20	FRN020AR1■-4U							
	25	FRN025AR1■-4U	Figure C	M6	51.3	M6	51.3		
	30	FRN030AR1■-4U							
	40	FRN040AR1■-4U	Figure D	M8	119.4	M8	119.4		
	50	FRN050AR1■-4U							
	60	FRN060AR1■-4U	Figure E	M10	238.9	M10	238.9		
	75	FRN075AR1■-4U							
	100	FRN100AR1■-4U	Figure F	M10	238.9	M8	119.4		
	125	FRN125AR1■-4U							
	150	FRN150AR1S-4U	Figure G	M12	424.7	M10	238.9		
	200	FRN200AR1S-4U							
	250	FRN250AR1S-4U	Figure H	M12	424.7	M10	238.9		
	300	FRN300AR1S-4U							
350	FRN350AR1S-4U	Figure I	M12	424.7	M10	238.9			
450	FRN450AR1S-4U								
500	FRN500AR1S-4U	Figure J	M12	424.7	M10	238.9			
600	FRN600AR1S-4U								
800	FRN800AR1S-4U	Figure K	M12	424.7	M10	238.9			
900	FRN900AR1S-4U								
1000	FRN1000AR1S-4U								

Note: A box (■) replaces an alphabetic letter depending on the enclosure. M (NEMA/UL TYPE 1) or L (NEMA/UL TYPE 12)

■ Screw Specifications (575 V class series)

Power supply voltage	Nominal applied motor (HP)	Inverter type	Refer to:	Main circuit terminals		Grounding terminals		Aux. control power supply Aux. main circuit power supply	
				Screw size	Tightening torque (lb-in)	Screw size	Tightening torque (lb-in)	Screw size	Tightening torque (lb-in)
Three-phase 575V	1	FRN001AR1■-5U	Figure A	M4	15.9	M4	15.9	M3.5	10.6
	2	FRN002AR1■-5U							
	3	FRN003AR1■-5U							
	5	FRN005AR1■-5U							
	7.5	FRN007AR1■-5U							
	10	FRN010AR1■-5U							
	15	FRN015AR1■-5U	Figure B	M6	51.3	M6	51.3		
	20	FRN020AR1■-5U							
	25	FRN025AR1■-5U							
	30	FRN030AR1■-5U	Figure C	M6	51.3	M6	51.3		
	40	FRN040AR1■-5U							
	50	FRN050AR1■-5U	Figure D	M8	119.4	M8	119.4		
	60	FRN060AR1■-5U							
	75	FRN075AR1■-5U	Figure E	M10	238.9	M10	238.9		
	100	FRN100AR1■-5U							
	125	FRN125AR1■-5U							
	150	FRN150AR1■-5U	Figure G	M12	424.7	M10	238.9		
200	FRN200AR1S-5U								
250	FRN250AR1S-5U								
300	FRN300AR1S-5U								

Note: A box (■) replaces an alphabetic letter depending on the enclosure.
M (NEMA/UL TYPE 1) or L (NEMA/UL TYPE 12)

⚠ WARNING ⚠

When the inverter power is ON, a high voltage is applied to the following terminals.

Main circuit terminals: L1/R, L2/S, L3/T, P(+), N(-), U, V, W, R0, T0, R1, T1, AUX-contact (30A, 30B, 30C, Y5A, Y5C)

Insulation level

Main circuit-Enclosure : Basic insulation (Overvoltage category III, Pollution degree 2)

Main circuit-Control circuit : Reinforced insulation (Overvoltage category III, Pollution degree 2)

Relay output-Control circuit : Reinforced insulation (Overvoltage category II, Pollution degree 2)

An electric shock may occur.

■ Terminal Arrangement Diagrams

Figure A

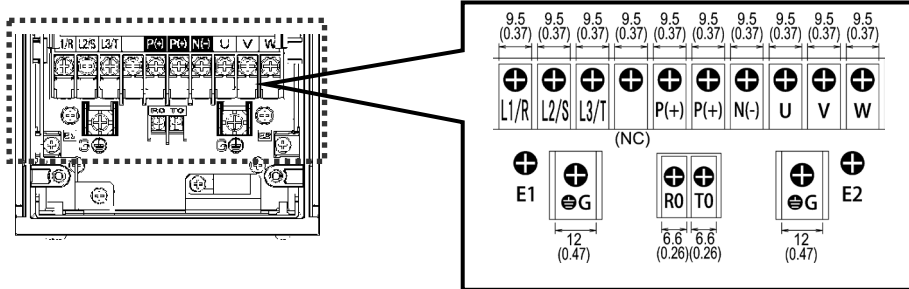

Figure B

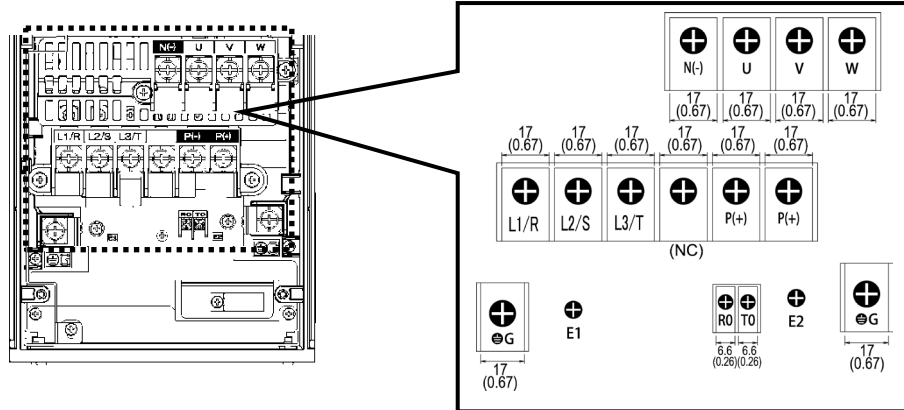
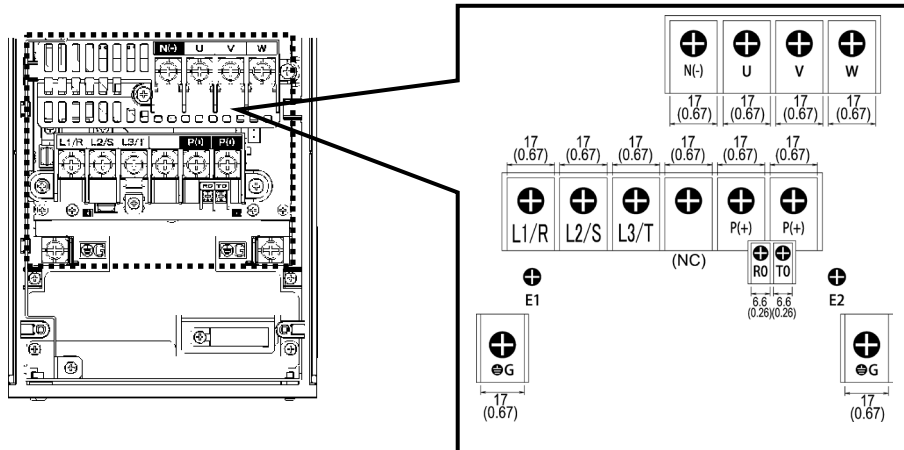

Figure C



Unit: mm (inch)

(NC): No connection (Do not make wiring.)

Figure D

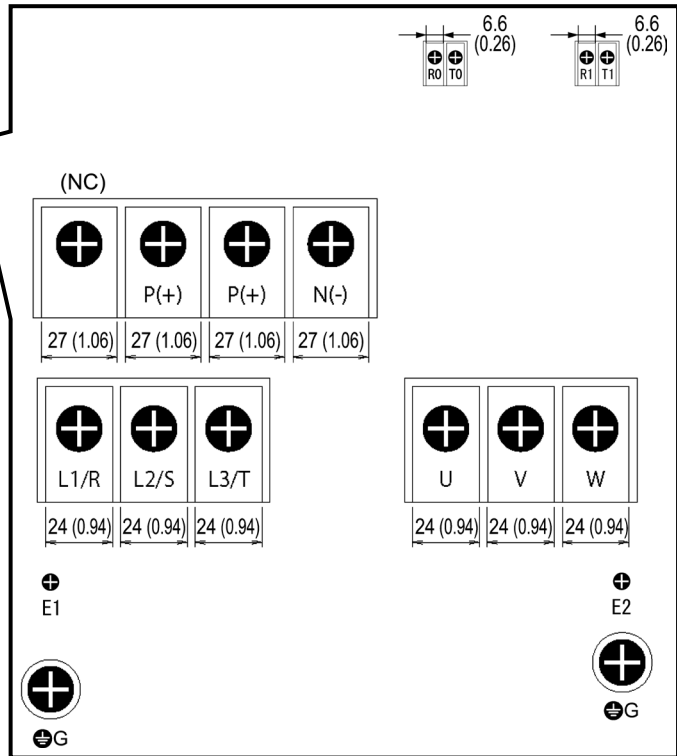
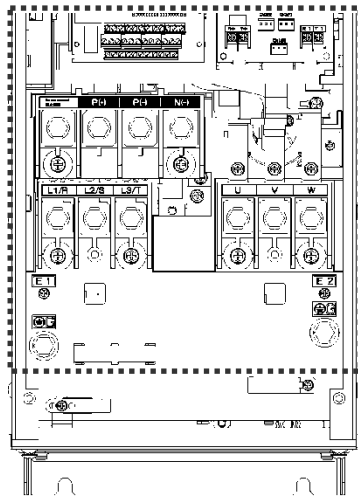
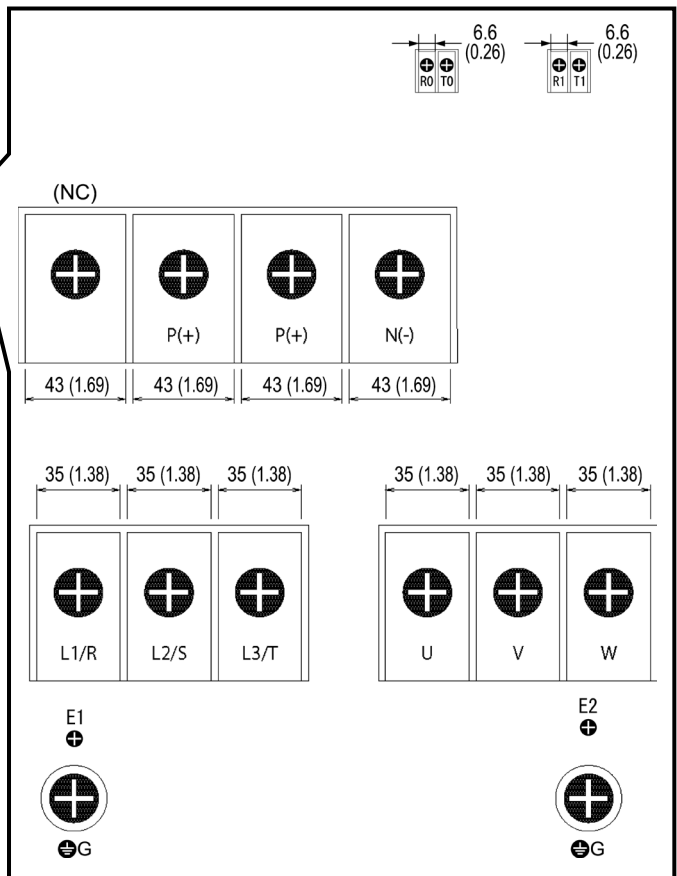
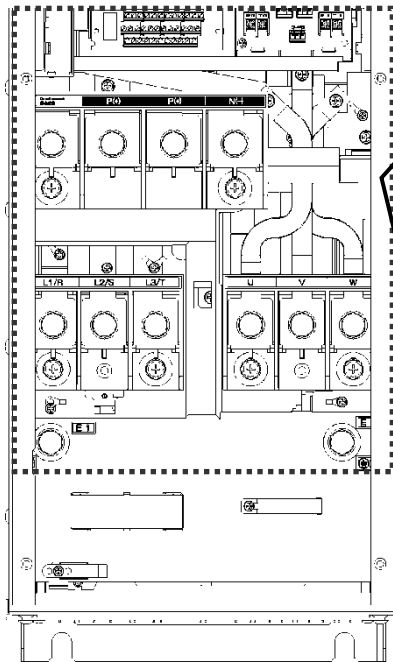

Figure E



Unit: mm (inch)
 (NC): No connection (Do not make wiring.)

Figure F

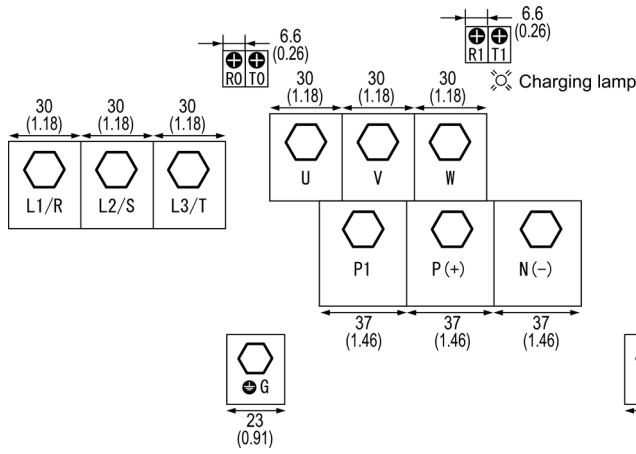

Figure G/
Figure H

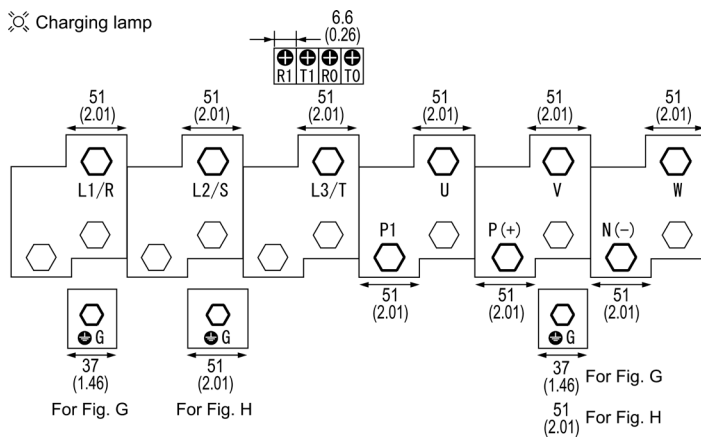
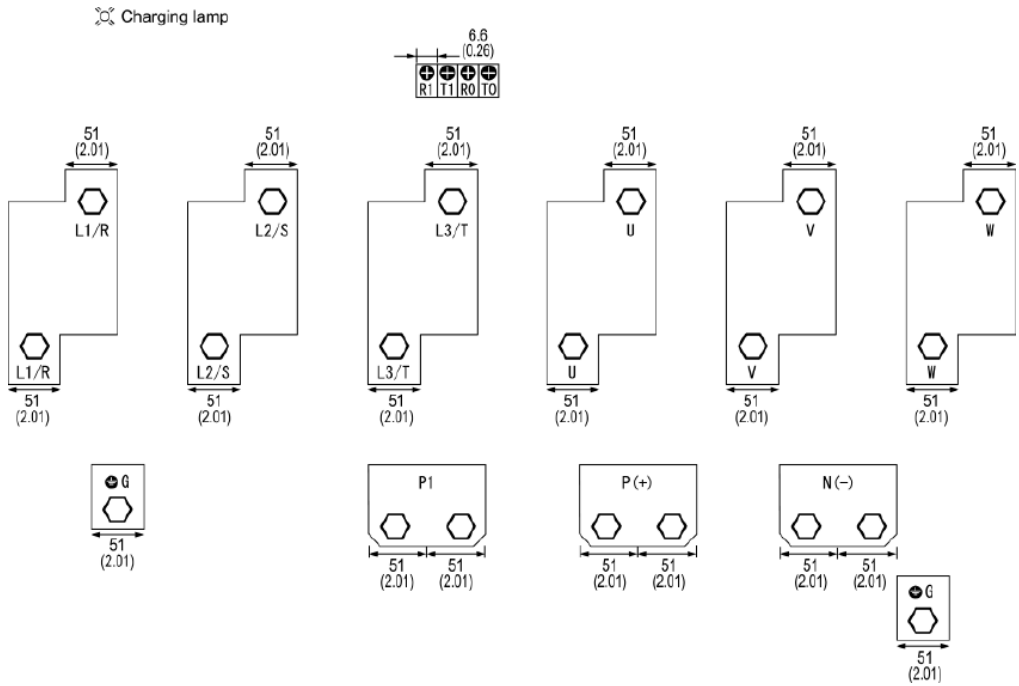

Figure I



Unit: mm (inch)

Figure J

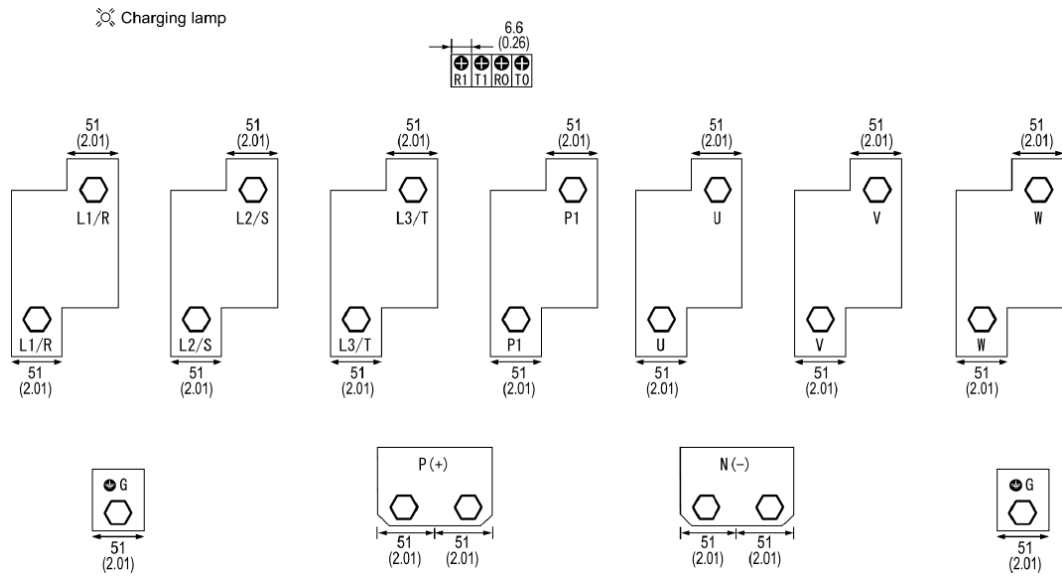

Figure K

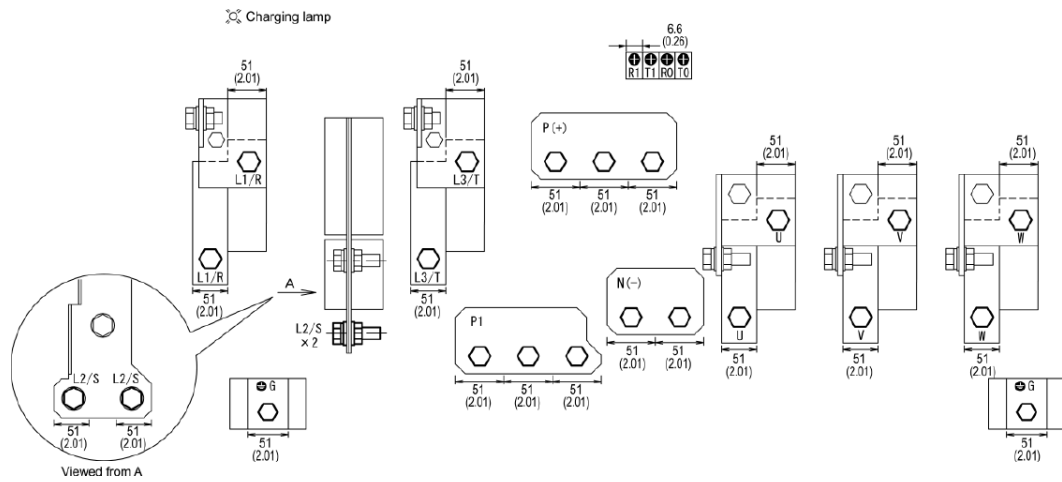
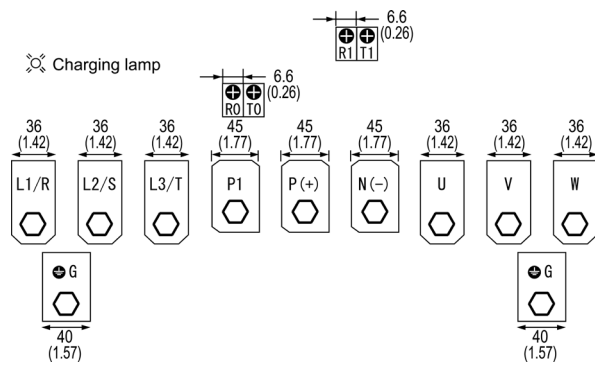

Figure L



Unit: mm (inch)

2.3.3.2 Control circuit terminals (Common to all inverter types)

The control circuit terminal arrangement, screw sizes, and tightening torque are shown below. The control circuit terminals are common to all inverter types regardless of their capacities.

Screw type of terminal block

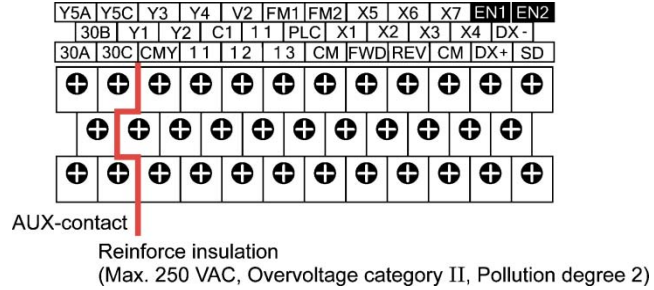

Table 2.2 Control Circuit Terminals

Terminal block type	Screw specifications		Recommended wire size (mm ²)
	Screw size	Tightening torque	
Screw type	M3	0.7 N·m (6.2 lb-in)	AWG 18 (0.75 mm ²)

2.4 Conduits

To ensure NEMA/UL Type 12 rating, mount conduits on the wiring plate in wiring. The conduits should be selected according to the number of wires to be connected and the wire size.

Sections 2.4.1 give the sizes of the conduits to be applied when the wires of the recommended sizes are used. Their sizes and mounting positions differ depending upon the inverter capacity.

2.4.1 Conduits

The tables given below list examples of recommended conduits. Use the equivalents.

(1) FRN001AR1■-2U to FRN005AR1■-2U and FRN001AR1■-4U/5U to FRN010AR1■-4U/5U (See Figure A.)

Punch-out # in wiring plate	Conduit body *1		Nut *1		Recommended wiring examples
	BULLET models	Size (inch)	Locknut models	Size (inch)	
1	LT75P	3/4	142	3/4	For inverter output *2
2	LT50P	1/2	141	1/2	For connection to the DC link bus
3	LT75P	3/4	142	3/4	For main power input and auxiliary input of control power *2
4	LT125P	1 1/4	144	1 1/4	For wiring to the control terminal block
5	LT75P	3/4	142	3/4	For wiring to option cards, etc.

*1 Manufacturer: Thomas & Betts (T & B)

*2 Prepunched

(2) FRN007AR1■-2U to FRN015AR1■-2U and FRN015AR1■-4U/5U to FRN030AR1■-4U/5U (See Figure B.)

Punch-out # in wiring plate	Conduit body *1		Nut *1		Recommended wiring examples
	BULLET models	Size (inch)	Locknut models	Size (inch)	
1	LT125P	1 1/4	144	1 1/4	For inverter output *2
2	LT100P	1	143	1	For connection to the DC link bus
3	LT100P	1	143	1	For main power input and auxiliary input of control power *2
4	LT125P	1 1/4	144	1 1/4	For wiring to the control terminal block
5	LT75P	3/4	142	3/4	For wiring to option cards, etc.

*1 Manufacturer: Thomas & Betts (T & B)

*2 Prepunched

(3) FRN020AR1■-2U, FRN025AR1■-2U, FRN040AR1■-4U/5U, and FRN050AR1■-4U/5U (See Figure C.)

Punch-out # in wiring plate	Conduit body *1		Nut *1		Recommended wiring examples
	BULLET models	Size (inch)	Locknut models	Size (inch)	
1	LT200P	2	146	2	For inverter output *2
2	LT100P	1	143	1	For connection to the DC link bus
3	LT125P	1 1/4	144	1 1/4	For main power input and auxiliary input of control power *2
4	LT125P	1 1/4	144	1 1/4	For wiring to the control terminal block
5	LT75P	3/4	142	3/4	For wiring to option cards, etc.

*1 Manufacturer: Thomas & Betts (T & B)

*2 Prepunched

(4) FRN030AR1■-2U, FRN040AR1■-2U, FRN060AR1■-4U, and FRN075AR1■-4U/5U
(See Figure D.)

Punch-out # in wiring plate	Conduit body *1		Nut *1		Recommended wiring examples
	BULLET models	Size (inch)	Locknut models	Size (inch)	
1	H200-TB	2	Integrated in conduit body		For inverter output *2
2	H125-TB	1 1/4			For connection to the DC link bus
3	H150-TB	1 1/2			For main power input and auxiliary input of control power *2
4	H125-TB	1 1/4			For wiring to the control terminal block
5	H75-TB	3/4			For wiring to option cards, etc.

*1 Manufacturer: Thomas & Betts (T & B)

*2 Prepunched

(5) FRN050AR1■-2U, FRN060AR1■-2U, FRN100AR1■-4U, and FRN125AR1■-4U
FRN100AR1■-/5U to FRN150AR1■5U
(See Figure E.)

Punch-out # in wiring plate	Conduit body *1		Nut *1		Recommended wiring examples
	BULLET models	Size (inch)	Locknut models	Size (inch)	
1	H300-TB	3	Integrated in conduit body		For inverter output *2
2	H200-TB	2			For connection to the DC link bus
3	H250-TB	2 1/2			For main power input and auxiliary input of control power *2
4	H125-TB	1 1/4			For wiring to the control terminal block
5	H75-TB	3/4			For wiring to option cards, etc.

*1 Manufacturer: Thomas & Betts (T & B)

*2 Prepunched

Punch-out Arrangement in Wiring Plate

Figure A

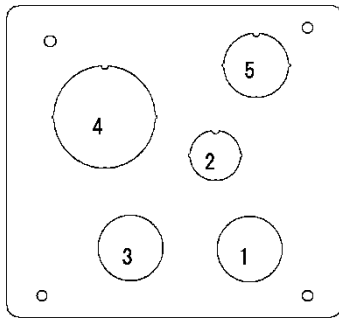

Figure B

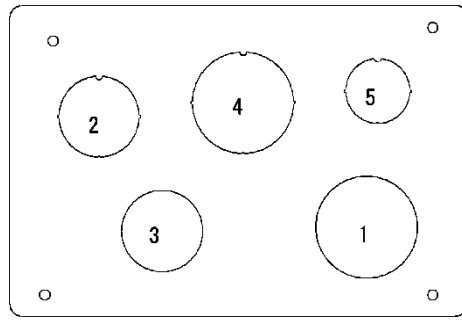

Figure C

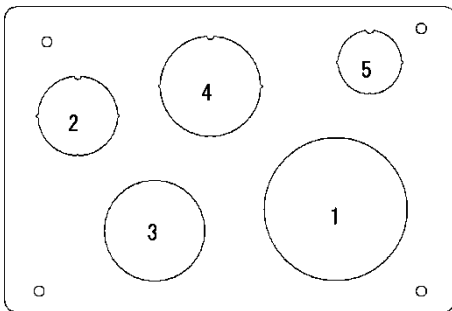

Figure D

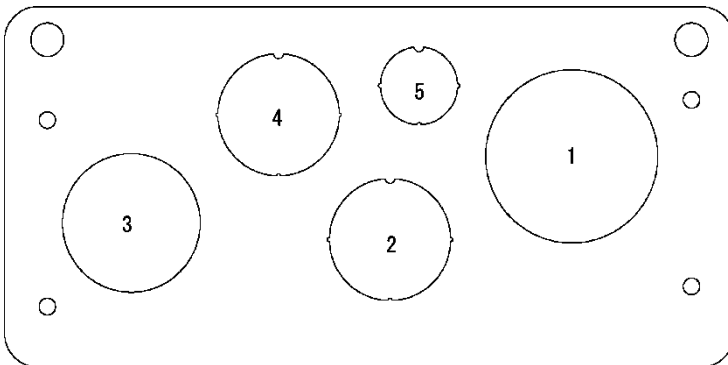
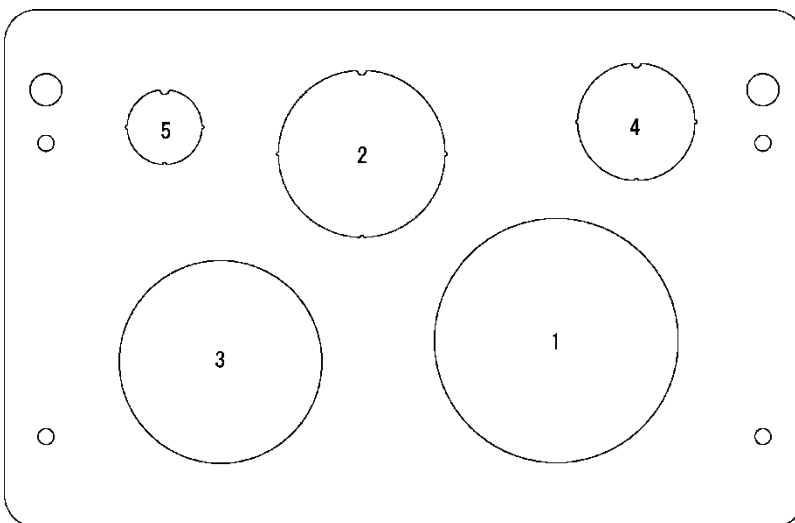



Figure E



 For instructions on how to punch out semi-perforated sections in the wiring plate and set conduits on the wiring plate, refer to Chapter 5, Section 5.1.2.1 "(2) Punching out semi-perforated sections in the wiring plate and setting conduits."

2.5 Leakage Current of the EMC Filter

This product uses grounding capacitors for noise suppression which increase the leakage current. Check whether there is no problem with power supply systems.

⚠ CAUTION ⚠	
As the leakage current of the EMC filter is relatively high, it is important to always assure a reliable connection to Protection Earth (PE).	
An electric shock may occur.	

Table 2.3 Leakage Current of EMC Filter

Input power	Inverter type	Leakage current (mA)	
		Under normal conditions	Under worst-case conditions
Three-phase 230 V *1	FRN001AR1■-2U	86	140
	FRN002AR1■-2U		
	FRN003AR1■-2U		
	FRN005AR1■-2U		
	FRN007AR1■-2U	224	357
	FRN010AR1■-2U		
	FRN015AR1■-2U		
	FRN020AR1■-2U		
Three-phase 230 V *1	FRN025AR1■-2U	180	291
	FRN030AR1■-2U	198	314
	FRN040AR1■-2U		
	FRN050AR1■-2U	204	322
	FRN060AR1■-2U		
	FRN075AR1S-2U	18	23
	FRN100AR1S-2U		
	FRN125AR1S-2U		
Input power	Inverter type	Leakage current (mA)	
		Under normal conditions	Under worst-case conditions
Three-phase 460 V *2	FRN001AR1■-4U	55	164
	FRN002AR1■-4U		
	FRN003AR1■-4U		
	FRN005AR1■-4U		
	FRN007AR1■-4U		
	FRN010AR1■-4U		
	FRN015AR1■-4U	135	417
	FRN020AR1■-4U		
	FRN025AR1■-4U		
	FRN030AR1■-4U		
	FRN040AR1■-4U	111	381
	FRN050AR1■-4U		
	FRN060AR1■-4U	119	367
	FRN075AR1■-4U		
Three-phase 460 V *2	FRN100AR1■-4U	148	440
	FRN125AR1■-4U		
	FRN150AR1S-4U	3	34
	FRN200AR1S-4U		
	FRN250AR1S-4U		
	FRN300AR1S-4U		
	FRN350AR1S-4U		
	FRN450AR1S-4U		
	FRN500AR1S-4U		
	FRN600AR1S-4U		
	FRN800AR1S-4U		
FRN900AR1S-4U			
FRN1000AR1S-4U			

*1 Calculated based on these measuring conditions: 200 V/ 50 Hz, grounding of a single wire in delta-connection, interphase voltage unbalance ratio 2%.

*2 Calculated based on these measuring conditions: 400 V/ 50 Hz, neutral grounding in Y-connection, interphase voltage unbalance ratio 2%.

Note The worst-case conditions include input phase loss.

Table 2.3 Leakage Current of EMC Filter(continue)

Input power	Inverter type	Leakage current (mA)		Input power	Inverter type	Leakage current (mA)	
		Under normal conditions	Under worst-case conditions			Under normal conditions	Under worst-case conditions
Three-phase 575 V *3	FRN001AR1■-5U	68	119	Three-phase 575 V *3	FRN040AR1■-5U	56	149
	FRN002AR1■-5U				FRN050AR1■-5U		
	FRN003AR1■-5U				FRN060AR1■-5U	98	375
	FRN005AR1■-5U				FRN075AR1■-5U		
	FRN007AR1■-5U				FRN100AR1■-5U	108	393
	FRN010AR1■-5U				FRN125AR1■-5U		
	FRN015AR1■-5U	34	113		FRN150AR1■-5U	18	79
	FRN020AR1■-5U				FRN200AR1S-5U		
	FRN025AR1■-5U				FRN250AR1S-5U		
	FRN030AR1■-5U				FRN300AR1S-5U		

*3 Calculated based on these measuring conditions: 575 V/ 60 Hz, neutral grounding in Y-connection, interphase voltage unbalance ratio 2%.

Note The worst-case conditions include input phase loss.

Note Usually there is no need to do anything for the EMC filter.

When the leakage current from the connected EMC filter causes problems with the power supply system, removing screws from terminals [E1] and [E2] could improve the problem. Note that doing so loses the effect of the EMC filter so that the inverter is no longer compliant with the EMC standards. To remove those screws, consult your Fuji Electric representative.

For the location of terminals [E1] and [E2], see the arrangement of terminals given in Section 2.3.3.1.

The 230 V class series inverters of 75 HP or above and 460 V / 575 V ones of 150 HP or above have neither [E1] nor [E2]. If you need to separate the EMC filter from those inverters, consult your Fuji Electric representative.

- FRN001AR1-2U to FRN025AR1-2U, FRN001AR1-4U/5U to FRN050AR1-4U/5U

Removing the screws from terminals [E1] and [E2] separates the grounding capacitors, decreasing the leakage current.

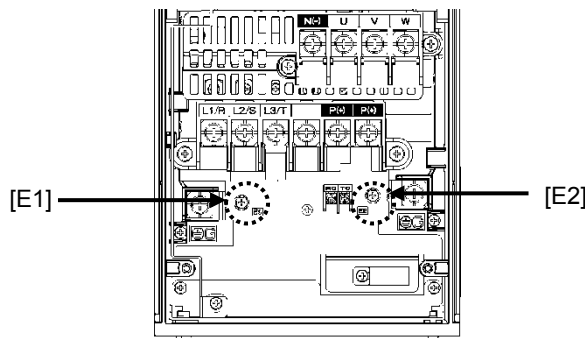

- FRN030AR1-2U to FRN060AR1-2U, FRN060AR1-4U to FRN125AR1-4U
FRN060AR1-5U to FRN150AR1-5U

Secure the filter grounding wires to the supports, using the screws removed from terminals [E1] and [E2].

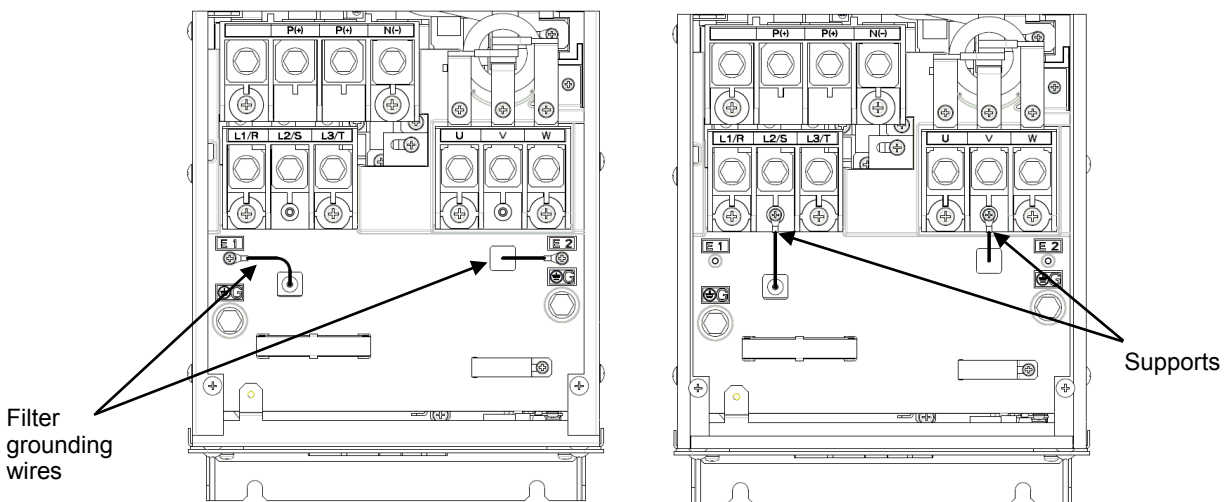

2.6 Derating of Rated Output Current

When increasing the carrier frequency setting (Function code F26) greater than the factory default 2 kHz, you need to derate the output current rating. Derating allows the higher ambient temperature than the rating. The tables below list the derating factors in relation to the carrier frequency and ambient temperature. Use the inverters within the range specified below.

- (1) **NEMA/UL TYPE1 : FRN001AR1M-2U to FRN060AR1M-2U, FRN001AR1M-4U to FRN125AR1M-4U**
NEMA/UL TYPE 12: FRN001AR1L-2U to FRN060AR1L-2U, FRN001AR1L-4U to FRN125AR1L-4U

Carrier frequency setting (kHz)	Output current derating factor (rated current ratio)						
	NEMA/UL TYPE1 50°C (122°F)	NEMA/UL TYPE1 60°C (140°F)	NEMA/UL TYPE12 40°C (104°F)	NEMA/UL TYPE12, 50°C (122°F)			
				Group 1	Group 2	Group 3	Group 4
0.75 to 2	100%	50%	100%	90%	80%	75%	70%
3	100%	50%	100%	90%	80%	75%	70%
4	93%	47%	93%	84%	74%	70%	65%
5	87%	44%	87%	78%	70%	65%	61%
6	81%	41%	81%	73%	65%	61%	57%
7	76%	38%	76%	68%	61%	57%	53%
8	72%	36%	72%	65%	58%	54%	50%
9	68%	34%	68%	61%	54%	51%	48%
10	64%	32%	64%	58%	51%	48%	45%
11	60%	30%	60%	54%	48%	45%	42%
12	57%	29%	57%	51%	46%	43%	40%
13	55%	28%	55%	50%	44%	41%	39%
14	52%	26%	52%	47%	42%	39%	36%
15	50%	25%	50%	45%	40%	38%	35%
16	47%	24%	47%	42%	38%	35%	33%

Note: For 230 V class series inverters of 30 to 100 HP and 460 V ones of 60 to 125 HP, the upper limit of the carrier frequency is 10 kHz.

Group 1	230V class series: FRN001AR1L-2U, FRN003AR1L-2U 460V class series: FRN001AR1L-4U, FRN002AR1L-4U, FRN003AR1L-4U, FRN007AR1L-4U
Group 2	230V class series: FRN005AR1L-2U, FRN007AR1L-2U, FRN010AR1L-2U 460V class series: FRN010AR1L-4U, FRN020AR1L-4U, FRN100AR1L-4U, FRN125AR1L-4U
Group 3	230V class series: FRN002AR1L-2U, FRN015AR1L-2U 460V class series: FRN005AR1L-4U, FRN015AR1L-4U, FRN025AR1L-4U, FRN030AR1L-4U, FRN060AR1L-4U, FRN075AR1L-4U
Group 4	230V class series: FRN020AR1L-2U, FRN025AR1L-2U 460V class series: FRN040AR1L-4U, FRN050AR1L-4U

Note: About FRN030AR1L-2U to FRN060AR1L-2U, consult your Fuji Electric representative.

Contact Fuji Electric for details on 575V class series derating curves.

(2) Open type: FRN075AR1S-2U, FRN100AR1S-2U

Carrier frequency setting (kHz)	Output current derating factor (rated current ratio)	
	Ambient temperature 40°C(104°F)	Ambient temperature 50°C(122°F)
0.75 to 2	100%	100%
3	100%	100%
4	100%	100%
5	100%	100%
6	100%	100%
7	100%	95%
8	100%	90%
9	100%	85%
10	100%	80%

(3) Open type: FRN125AR1S-2U

Carrier frequency setting (kHz)	Output current derating factor (rated current ratio)	
	Ambient temperature 40°C(104°F)	Ambient temperature 50°C(122°F)
0.75 to 2	100%	100%
3	100%	100%
4	100%	100%
5	100%	95%
6	100%	85%

(4) Open type: FRN150AR1S-4U to FRN1000AR1S-4U

Carrier frequency setting (kHz)	Output current derating factor (rated current ratio)	
	Ambient temperature 40°C(104°F)	Ambient temperature 50°C(122°F)
0.75 to 2	100%	100%
3	100%	100%
4	100%	100%
5	100%	90%
6	100%	80%

Note: For 460 V class series inverters of 1000 HP, the upper limit of the carrier frequency is 4 kHz.

2.7 Operating Environment and Storage Environment

2.7.1 Operating environment

Install the inverter in an environment that satisfies the requirements listed below.

Table 2.4 Environmental Requirements

Item	Specifications		
Site location	Indoors		
Ambient temperature	<p><u>NEMA/UL TYPE 1</u> -10 to +50°C (14 to 122°F) (-10 to +40°C (14 to 104°F) for inverters mounted closely side by side*) +50 to +60°C (122 to 140°F) (when current derating)</p> <p><u>NEMA/UL TYPE 12</u> -10 to +40°C (14 to 104°F) (-10 to +30°C for inverters mounted closely side by side*) +40 to +50°C (104 to 122°F) (when current derating)</p> <p><u>UL open type</u> -10 to +50°C (14 to 122°F)</p> <p>*The 230 V class series inverters of 25 HP or below and 460 V / 575 V ones of 50 HP or below can be mounted closely side by side.</p>		
Relative humidity	5 to 95% (No condensation)		
Atmosphere	<p>The inverter must not be exposed to dusts, direct sunlight, corrosive or flammable gases, oil mist, vapor or water drops. Pollution degree 2 (IEC/EN 60664-1) (Note 1)</p> <p>The atmosphere can contain a small amount of salt. (0.01 mg/cm² or less per year)</p> <p>The inverter must not be subjected to sudden changes in temperature that will cause condensation to form.</p>		
Altitude	1000 m (3300 ft) max. (Note 2)		
Atmospheric pressure	86 to 106 kPa		
Vibration	<p><u>230 V 60 HP or below</u> <u>460 V 125 HP or below</u> <u>575 V 150 HP or below</u></p> <p>3 mm (0.12 inch): 2 to less than 9 Hz 10 m/s²: 9 to less than 200 Hz</p>	<p><u>230 V 75 HP 100HP</u></p> <p>3 mm (0.12 inch): 2 to less than 9 Hz 9.8 m/s²: 9 to less than 20 Hz 2 m/s²: 20 to less than 55 Hz 1 m/s²: 55 to less than 200 Hz</p>	<p><u>230 V 125HP</u> <u>460 V 150 to 1000 HP</u> <u>575 V 200 to 300 HP</u></p> <p>3 mm (0.12 inch): 2 to less than 9 Hz 2 m/s²: 9 to less than 55 Hz 1 m/s²: 55 to less than 200 Hz</p>

(Note 1) Do not install the inverter in an environment where it may be exposed to cotton waste or moist dust or dirt which will clog the heat sink in the inverter. If the inverter is to be used in such an environment, install it in the panel of your system or other dustproof containers.

(Note 2) If you use the inverter in an altitude above 1000 m (3300 ft), you should apply an output current derating factor as listed in Table 2.5.

Table 2.5 Output Current Derating Factor in Relation to Altitude

Altitude	Output current derating factor
1000 m (3300 ft) or lower	1.00
1000 to 1500 m (3300 to 4900 ft)	0.97
1500 to 2000 m (4900 to 6600 ft)	0.95
2000 to 2500 m (6600 to 8200 ft)	0.91
2500 to 3000 m (8200 to 9800 ft)	0.88

2.7.2 Storage environment

2.7.2.1 Temporary storage

Store the inverter in an environment that satisfies the requirements listed below.

Table 2.6 Storage and Transport Environments

Item	Specifications	
Storage temperature *1	-25 to +70°C (-13 to +158°F)	Places not subjected to abrupt temperature changes or condensation or freezing
Relative humidity	5 to 95% *2	
Atmosphere	The inverter must not be exposed to dusts, direct sunlight, corrosive or flammable gases, oil mist, vapor, water drops or vibration. The atmosphere must contain only a low level of salt. (0.01 mg/cm ² or less per year)	
Atmospheric pressure	86 to 106 kPa (during storage)	
	70 to 106 kPa (during transportation)	

*1 Assuming comparatively short time storage, e.g., during transportation or the like.

*2 Even if the humidity is within the specified requirements, avoid such places where the inverter will be subjected to sudden changes in temperature that will cause condensation to form.

Precautions for temporary storage

- (1) Do not leave the inverter directly on the floor.
- (2) If the environment does not satisfy the specified requirements listed in Table 2.6 wrap the inverter in an airtight vinyl sheet or the like for storage.
- (3) If the inverter is to be stored in a high-humidity environment, put a drying agent (such as silica gel) in the airtight package described in item (2).

2.7.2.2 Long-term storage

The long-term storage method of the inverter varies largely according to the environment of the storage site. General storage methods are described below.

- (1) The storage site must satisfy the requirements specified for temporary storage.
However, for storage exceeding three months, the ambient temperature range should be within the range from -10 to 30°C (14 to 86°F). This is to prevent electrolytic capacitors in the inverter from deterioration.
- (2) The package must be airtight to protect the inverter from moisture. Add a drying agent inside the package to maintain the relative humidity inside the package within 70%.
- (3) If the inverter has been installed to the equipment or panel at construction sites where it may be subjected to humidity, dust or dirt, then temporarily remove the inverter and store it in the environment specified in Table 2.6.

Precautions for storage over 1 year

If the inverter has not been powered on for a long time, the property of the electrolytic capacitors may deteriorate. Power the inverters on once a year and keep the inverters powering on for 30 to 60 minutes. Do not connect the inverters to the load circuit (secondary side) or run the inverter.

2.8 Precautions for Using Inverters

2.8.1 Precautions in introducing inverters

This section provides precautions in introducing inverters, e.g. precautions for installation environment, power supply lines, wiring, and connection to peripheral equipment. Be sure to observe those precautions.

■ Installation environment

Install the inverter in an environment that satisfies the requirements listed in Table 2.4 in Section 2.7.1. Fuji Electric strongly recommends installing inverters in a panel for safety reasons, in particular, when installing the ones whose enclosure rating is UL open type.

When installing the inverter in a place out of the specified environmental requirements, it is necessary to derate the inverter or consider the panel engineering suitable for the special environment or the panel installation location.

The special environments listed below require using the specially designed panel or considering the panel installation location

Unusual environments	Possible problems	Sample measures	Remarks
Highly concentrated sulfidizing gas or other corrosive gases	Corrosive gases cause parts inside the inverter to corrode, resulting in an inverter malfunction.	Any of the following measures may be necessary. - Mount the inverter in a sealed panel with IP6X or air-purge mechanism. - Place the panel in a room free from influence of the gases.	
A lot of conductive dust or foreign material (e.g., metal powders or shavings, carbon fibers, or carbon dust)	Entry of conductive dust into the inverter causes a short circuit.	Any of the following measures may be necessary. - Mount the inverter in a sealed panel. - Place the panel in a room free from influence of the conductive dust.	
A lot of fibrous or paper dust	Fibrous or paper dust accumulated on the heat sink lowers the cooling effect. Entry of dust into the inverter causes the electronic circuitry to malfunction.	Any of the following measures may be necessary. - Mount the inverter in a sealed panel that shuts out dust. - Ensure a maintenance space for periodical cleaning of the heat sink in panel engineering design. - Employ external cooling when mounting the inverter in a panel for easy maintenance and perform periodical maintenance.	
High humidity or dew condensation	In an environment where a humidifier is used or where the air conditioner is not equipped with a dehumidifier, high humidity or dew condensation results, which causes a short-circuiting or malfunction of electronic circuitry inside the inverter.	- Put a heating module such as a space heater in the panel.	
Vibration or shock exceeding the specified level	If a large vibration or shock exceeding the specified level is applied to the inverter, for example, due to a carrier running on seam joints of rails or blasting at a construction site, the inverter structure gets damaged.	- Insert shock-absorbing materials between the mounting base of the inverter and the panel for safe mounting.	

Unusual environments	Possible problems	Sample measures	Remarks
Fumigation for export packaging	Halogen compounds such as methyl bromide used in fumigation corrodes some parts inside the inverter.	- When exporting an inverter built in a panel or equipment, pack them in a previously fumigated wooden crate. - When packing an inverter alone for export, use a laminated veneer lumber (LVL).	Exporting.

■ Wiring precautions

- (1) Route the wiring of the control circuit terminals as far from the wiring of the main circuit as possible. Otherwise electric noise may cause malfunctions.
- (2) Fix the control circuit wires with a cable tie inside the inverter to keep them away from the live parts of the main circuit (such as the terminal block of the main circuit).
- (3) If more than one motor is to be connected to a single inverter, the wiring length should be the sum of the length of the wires to the motors.
- (4) Precautions for high frequency leakage currents

If the wiring distance between an inverter and a motor is long, high frequency currents flowing through stray capacitance across wires of phases may cause an inverter overheat, overcurrent trip, increase of leakage current, or it may not assure the accuracy in measuring leakage current. Depending on the operating condition, an excessive leakage current may damage the inverter.

To avoid the above problems when directly connecting an inverter to a motor, keep the wiring distance 50 m (165 ft) or less for inverters of 3.7kW (5 HP) or below, and 100 m (328 ft) or less for inverters of a higher capacity. Output circuit filters cannot be used with the three-phase 575V class series.

If the wiring distance longer than the specified above is required, lower the carrier frequency or insert an output circuit filter (OFL-□□□-□A) as shown below.

When a single inverter drives two or more motors connected in parallel (group drive), in particular, when using shielded wires, the stray capacitance to the earth is large, so lower the carrier frequency or insert an output circuit filter (OFL-□□□-□A). Output circuit filters cannot be used with the three-phase 575V class series.

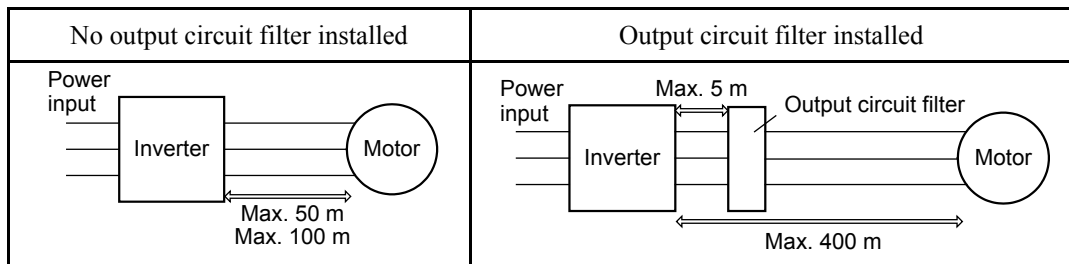

For an inverter with an output circuit filter installed, the total secondary wiring length should be 400 m (1312 ft) or less.

If further longer secondary wiring is required, consult your Fuji Electric representative.

- (5) Precautions for surge voltage in driving a motor by an inverter

If the motor is driven by a PWM-type inverter, surge voltage generated by switching the inverter component may be superimposed on the output voltage and may be applied to the motor terminals. Particularly if the wiring length is long, the surge voltage may deteriorate the insulation resistance of the motor. Implement any of the following measures.

- Use a motor with insulation that withstands the surge voltage. (All Fuji standard motors feature reinforced insulation.)
- Connect a surge suppressor unit (SSU50/100TA-NS) at the motor terminal.
- Connect an output circuit filter (OFL-□□□-□A) to the output terminals (secondary circuits) of the inverter.
- Minimize the wiring length between the inverter and motor (10 to 20 m (33 to 66ft) or less).

- (6) When an output circuit filter is inserted in the secondary circuit or the wiring between the inverter and the motor is long, a voltage loss occurs due to reactance of the filter or wiring so that the insufficient voltage may cause output current oscillation or a lack of motor output torque. To avoid it, select the constant torque load by setting the function code F37 (Load Selection/Auto Torque Boost/Auto Energy Saving Operation 1) to "1" and keep the inverter output voltage at a higher level by configuring H50/H52 (Non-linear V/f Pattern, Frequency) and H51/H53 (Non-linear V/f Pattern, Voltage).

■ Precautions for connection of peripheral equipment

- (1) Power supply lines (Using AC reactor)

If the interphase voltage unbalance ratio of the inverter power supply is 2 to 3%, use an optional AC reactor (ACR).

$$\text{Interphase voltage unbalance (\%)} = \frac{\text{Max. voltage (V)} - \text{Min. voltage (V)}}{\text{Three-phase average voltage (V)}} \times 67 \quad (\text{See IEC/EN 61800-3.})$$

- (2) Molded case circuit breaker (MCCB) or residual-current-operated protective device (RCD)/earth leakage circuit breaker (ELCB)



Install a recommended MCCB or RCD/ELCB (with overcurrent protection) in the primary circuit of the inverter to protect the wiring. Since using an MCCB or RCD/ELCB with a larger capacity than recommended ones breaks the protective coordination of the power supply system, be sure to select recommended ones. Also select ones with short-circuit breaking capacity suitable for the power source impedance.

⚠ WARNING

If no zero-phase current (earth leakage current) detective device such as a ground-fault relay is installed in the upstream power supply line in order to avoid the entire power supply system's shutdown undesirable to factory operation, install a residual-current-operated protective device (RCD)/earth leakage circuit breaker (ELCB) individually to inverters to break the individual inverter power supply lines only.

Otherwise, a fire could occur.

- (3) Magnetic contactor (MC) in the inverter input (primary) circuit

Avoid frequent ON/OFF operation of the magnetic contactor (MC) in the input circuit; otherwise, the inverter failure may result. If frequent start/stop of the motor is required, use **FWD/REV** terminal signals or the  /  and  keys on the inverter's keypad.

The frequency of the MC's ON/OFF should not be more than once per 30 minutes. To assure 5-year or longer service life of the inverter, it should not be more than once per hour.



From the system's safety point of view, it is recommended to employ such a sequence that shuts down the magnetic contactor (MC) in the inverter input circuit with an alarm output signal **ALM** issued on inverter's programmable output terminals. The sequence minimizes the secondary damage even if the inverter breaks.

When the sequence is employed, connecting the MC's primary power line to the inverter's auxiliary control power input makes it possible to monitor the inverter's alarm status on the keypad.

- (4) Magnetic contactor (MC) in the inverter output (secondary) circuit

If a magnetic contactor (MC) is inserted in the inverter's output (secondary) circuit for switching the motor to a commercial power or for any other purposes, it should be switched on and off when both the inverter and motor are completely stopped. This prevents the contact point from getting rough due to a switching arc of the MC. The MC should not be equipped with any main circuit surge killer (Fuji SZ-ZM□ etc.).

Applying a commercial power to the inverter's output circuit breaks the inverter. To avoid it, interlock the MC on the motor's commercial power line with the one in the inverter output circuit so that they are not switched ON at the same time.

- (5) Surge absorber/surge killer

Do not install any surge absorber or surge killer in the inverter's output (secondary) lines.

■ Noise reduction

If noise generated from the inverter affects other devices, or that generated from peripheral equipment causes the inverter to malfunction, follow the basic measures outlined below.

- (1) If noise generated from the inverter affects the other devices through power wires or grounding wires:
 - Isolate the grounding terminals of the inverter from those of the other devices.
 - Connect a noise filter to the inverter power wires.
 - Isolate the power system of the other devices from that of the inverter with an insulated transformer.
 - Decrease the inverter's carrier frequency (F26).
- (2) If induction or radio noise generated from the inverter affects other devices:
 - Isolate the main circuit wires from the control circuit wires and other device wires.
 - Put the main circuit wires through a metal conduit pipe, and connect the pipe to the ground near the inverter.
 - Install the inverter into the metal panel and connect the whole panel to the ground.
 - Connect a noise filter to the inverter's power wires.
 - Decrease the inverter's carrier frequency (F26).
- (3) When implementing measures against noise generated from peripheral equipment:
 - For inverter's control signal wires, use twisted or shielded-twisted wires. When using shielded-twisted wires, connect the shield of the shielded wires to the common terminals of the control circuit.
 - Connect a surge absorber in parallel with magnetic contactor's coils or other solenoids (if any).

■ Leakage current

A high frequency current component generated by insulated gate bipolar transistors (IGBTs) switching on/off inside the inverter becomes leakage current through stray capacitance of inverter input and output wires or a motor. If any of the problems listed below occurs, take an appropriate measure against them.

Problem	Measures
An earth leakage circuit breaker* that is connected to the input (primary) side has tripped. * With overcurrent protection	<ol style="list-style-type: none"> 1) Decrease the carrier frequency. 2) Make the wires between the inverter and motor shorter. 3) Use an earth leakage circuit breaker with lower sensitivity than the one currently used.
An external thermal relay was activated.	<ol style="list-style-type: none"> 1) Decrease the carrier frequency. 2) Increase the setting current of the thermal relay. 3) Use the electronic thermal overload protection built in the inverter, instead of the external thermal relay.

■ Selecting inverter capacity

- (1) To drive a general-purpose motor, select an inverter according to the nominal applied motor rating listed in the standard specifications table. When high starting torque is required or quick acceleration or deceleration is required, select an inverter with one rank higher capacity than the standard.
- (2) Special motors may have larger rated current than general-purpose ones. In such a case, select an inverter that meets the following condition.
Inverter rated current > Motor rated current

2.8.2 Precautions in running inverters

Precautions for running inverters to drive motors or motor-driven machinery are described below.

■ Motor temperature

When an inverter is used to run a general-purpose motor, the motor temperature becomes higher than when it is operated with a commercial power supply. In the low-speed range, the motor cooling effect will be weakened, so decrease the output torque of the motor when running the inverter in the low-speed range.

■ Motor noise

When a general-purpose motor is driven by an inverter, the noise level is higher than that when it is driven by a commercial power supply. To reduce noise, raise the carrier frequency of the inverter. Operation at 60 Hz or higher can also result in higher noise level.

■ Machine vibration

When an inverter-driven motor is mounted to a machine, resonance may be caused by the natural frequencies of the motor-driven machinery. Driving a 2-pole motor at 60 Hz or higher may cause abnormal vibration. If it happens, do any of the following:

- Consider the use of a rubber coupling or vibration-proof rubber.
- Use the inverter's jump frequency control feature to skip the resonance frequency zone(s).
- Use the vibration suppression related function codes that may be effective. For details, refer to the description of H80 in Chapter 6 "FUNCTION CODES."

2.8.3 Precautions in using special motors

When using special motors, note the followings.

■ Submersible motors and pumps

These motors have a larger rated current than general-purpose motors. Select an inverter whose rated output current is greater than that of the motor. These motors differ from general-purpose motors in thermal characteristics. Decrease the thermal time constant of the electronic thermal overload protection to match the motor rating.

■ Brake motors

For motors equipped with parallel-connected brakes, their power supply for braking must be supplied from the inverter input (primary) circuit. If the power supply for braking is mistakenly connected to the inverter's output (secondary) circuit, the brake may not work when the inverter output is shut down. Do not use inverters for driving motors equipped with series-connected brakes.

■ Geared motors

If the power transmission mechanism uses an oil-lubricated gearbox or speed changer/reducer, then continuous operation at low speed may cause poor lubrication. Avoid such operation.

2.9 External Dimensions

2.9.1 Standard models

FRN001AR1■-2U to FRN005AR1■-2U,
 FRN001AR1■-4U to FRN010AR1■-4U,
 FRN001AR1■-5U to FRN010AR1■-5U

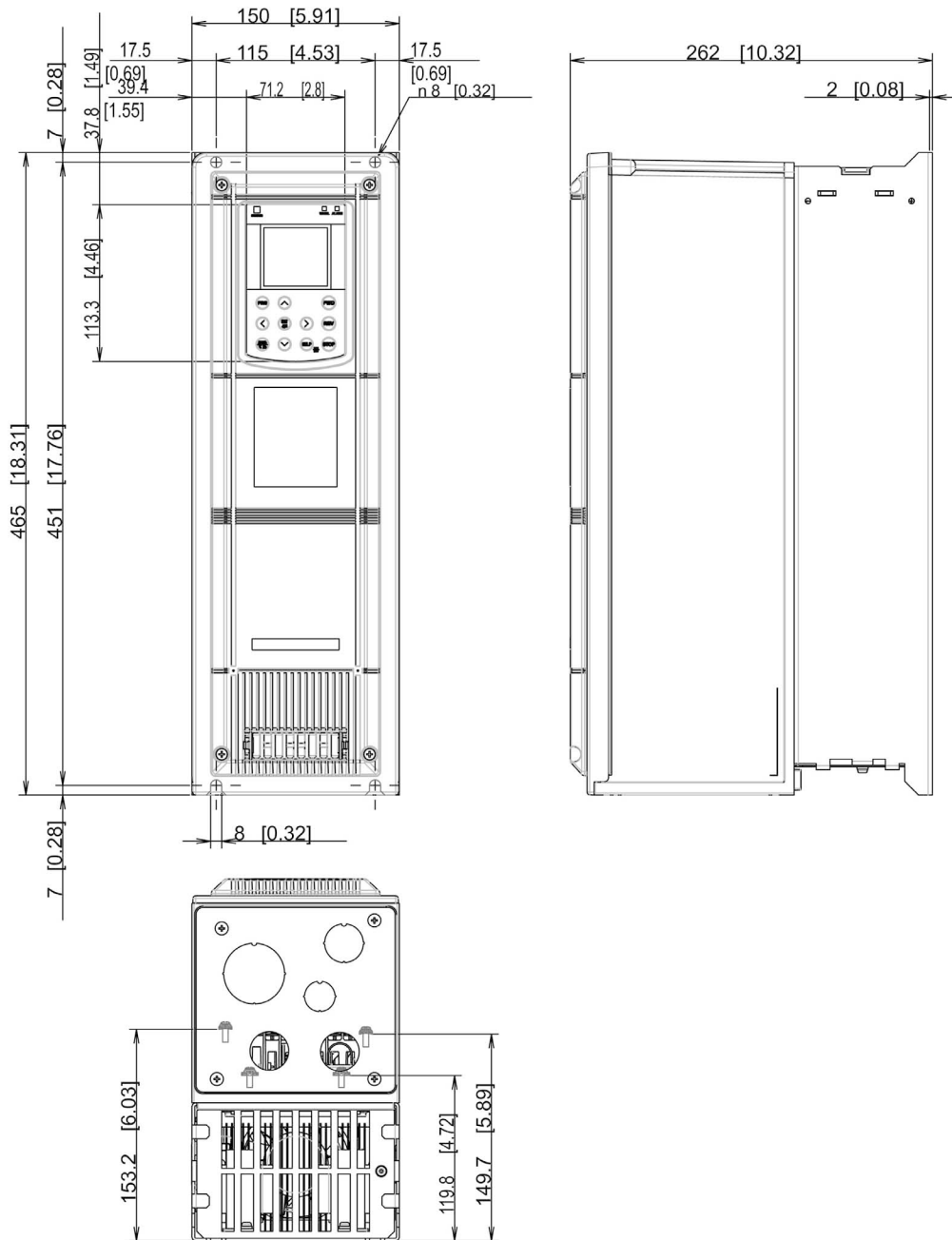

Figure 1 External Dimensions of the Inverter

FRN007AR1-2U to FRN015AR1-2U,
 FRN015AR1-4U to FRN030AR1-4U,
 FRN015AR1-5U to FRN030AR1-5U

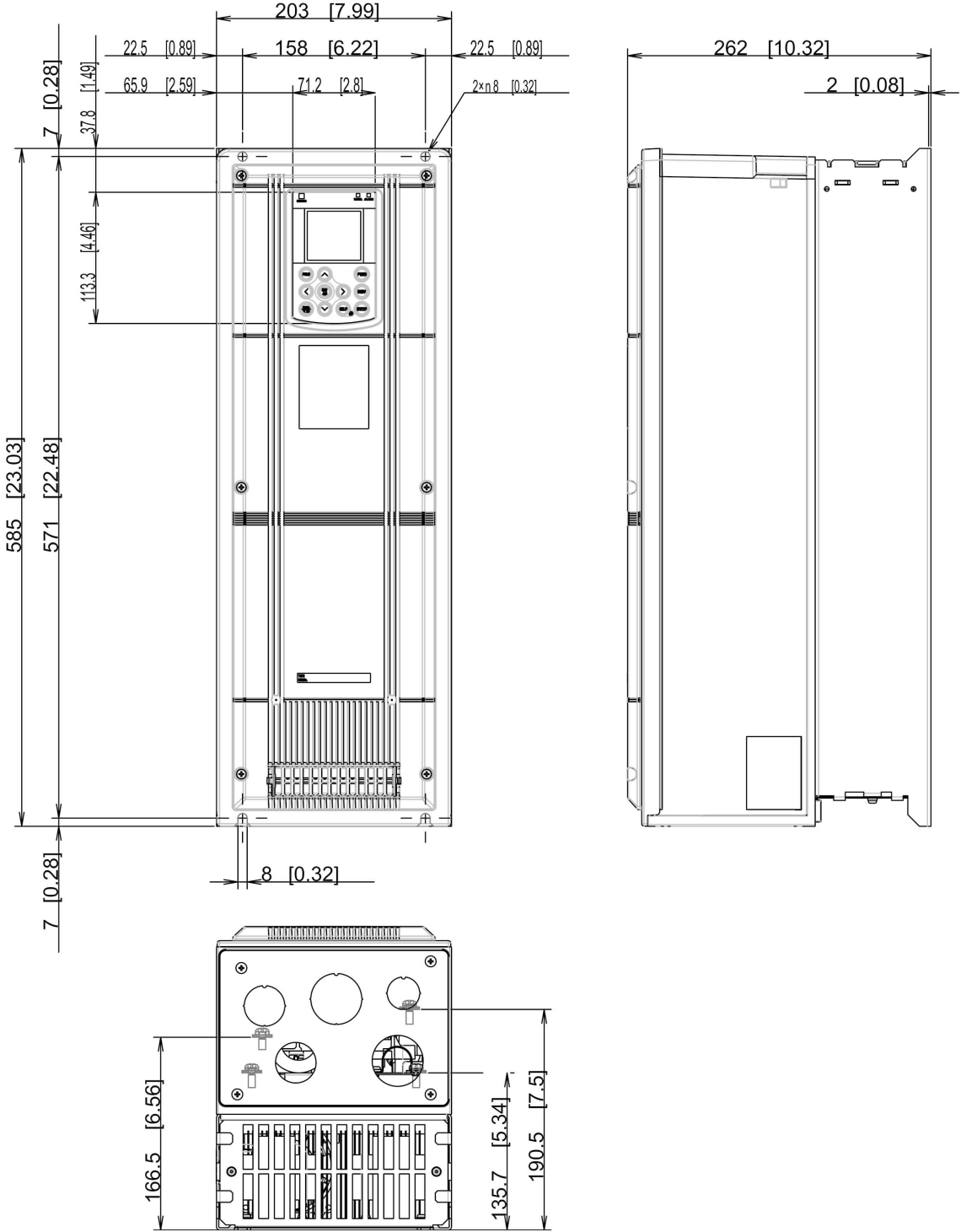

Figure 2 External Dimensions of the Inverter

FRN020AR1■-2U, FRN025AR1■-2U,
 FRN040AR1■-4U, FRN050AR1■-4U,
 FRN040AR1■-5U, FRN050AR1■-5U

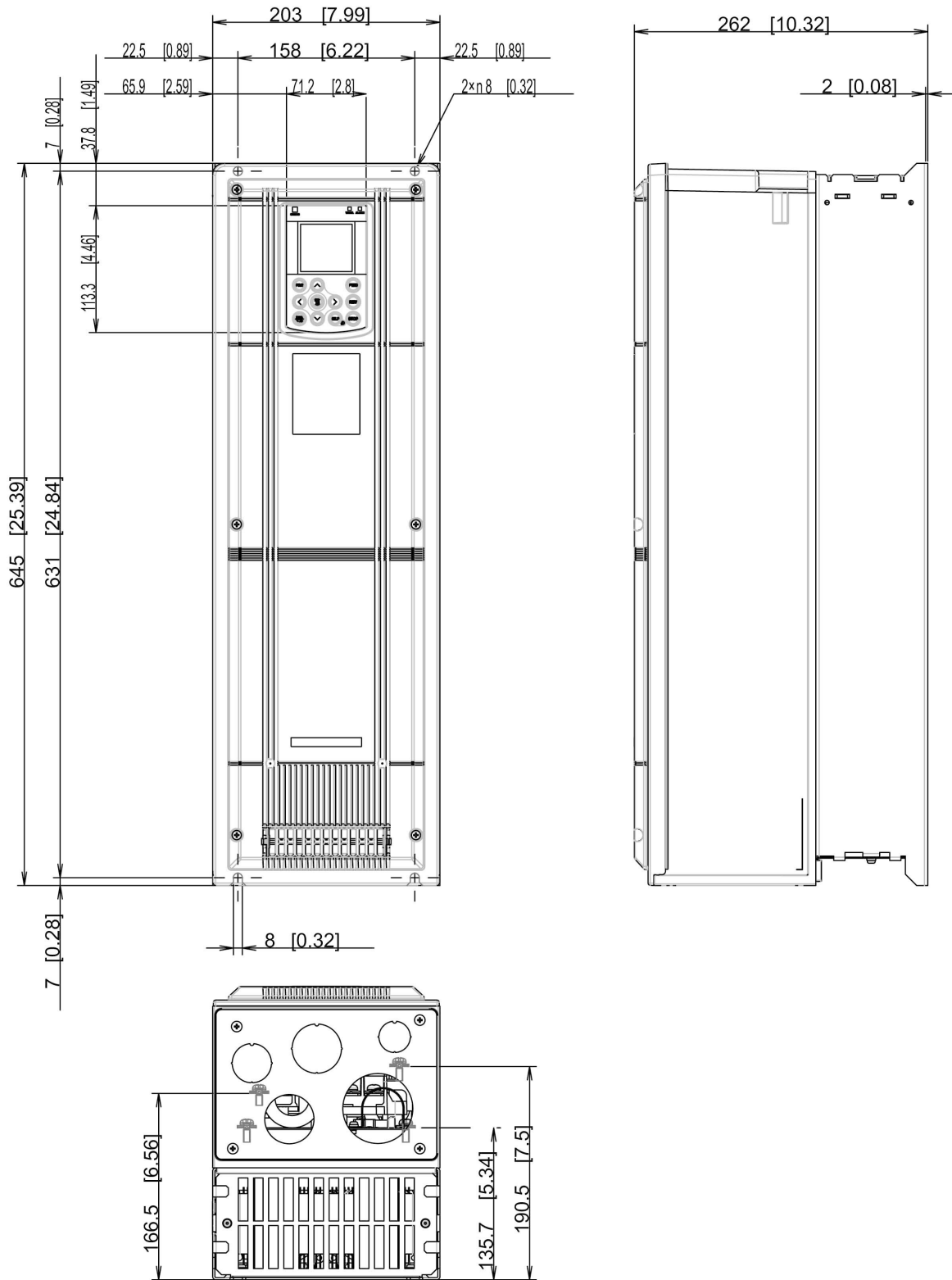

Figure 3 External Dimensions of the Inverter

FRN030AR1■-2U, FRN040AR1■-2U,
 FRN060AR1■-4U, FRN075AR1■-4U
 FRN060AR1■-5U, FRN075AR1■-5U

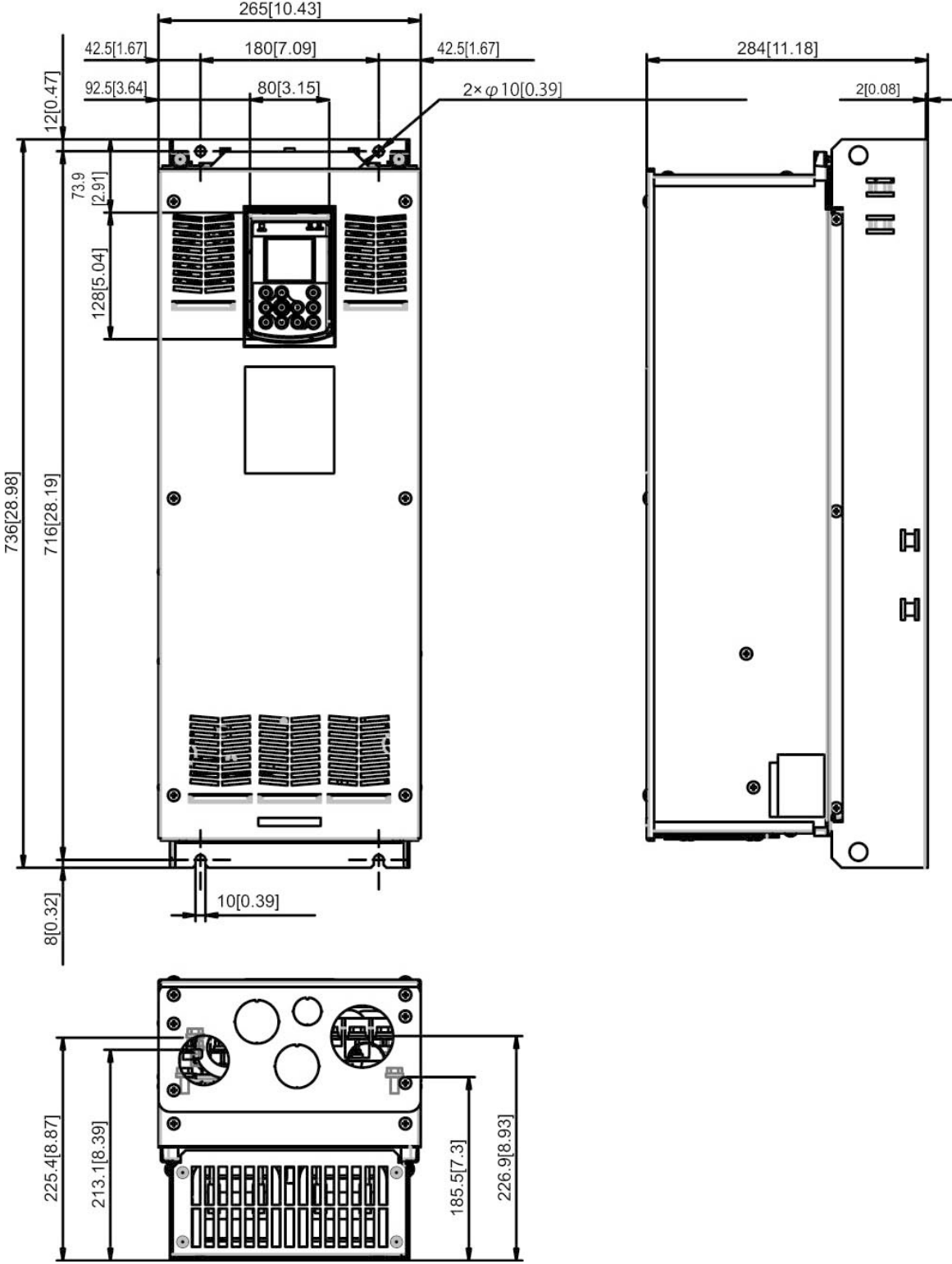

Figure 4 External Dimensions of the Inverter

FRN050AR1■-2U, FRN060AR1■-2U,
 FRN100AR1■-4U, FRN125AR1■-4U
 FRN100AR1■-5U, FRN150AR1■-5U

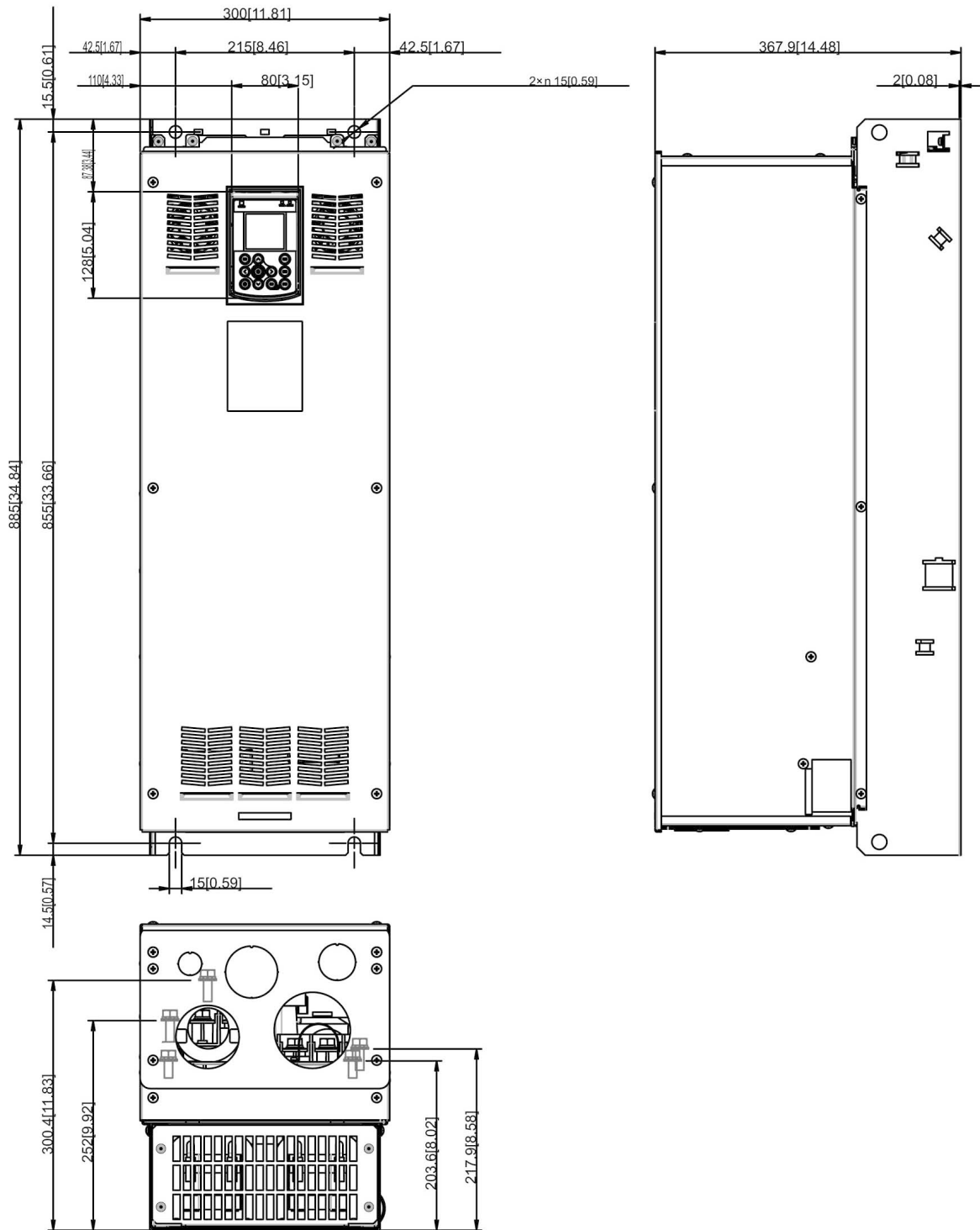
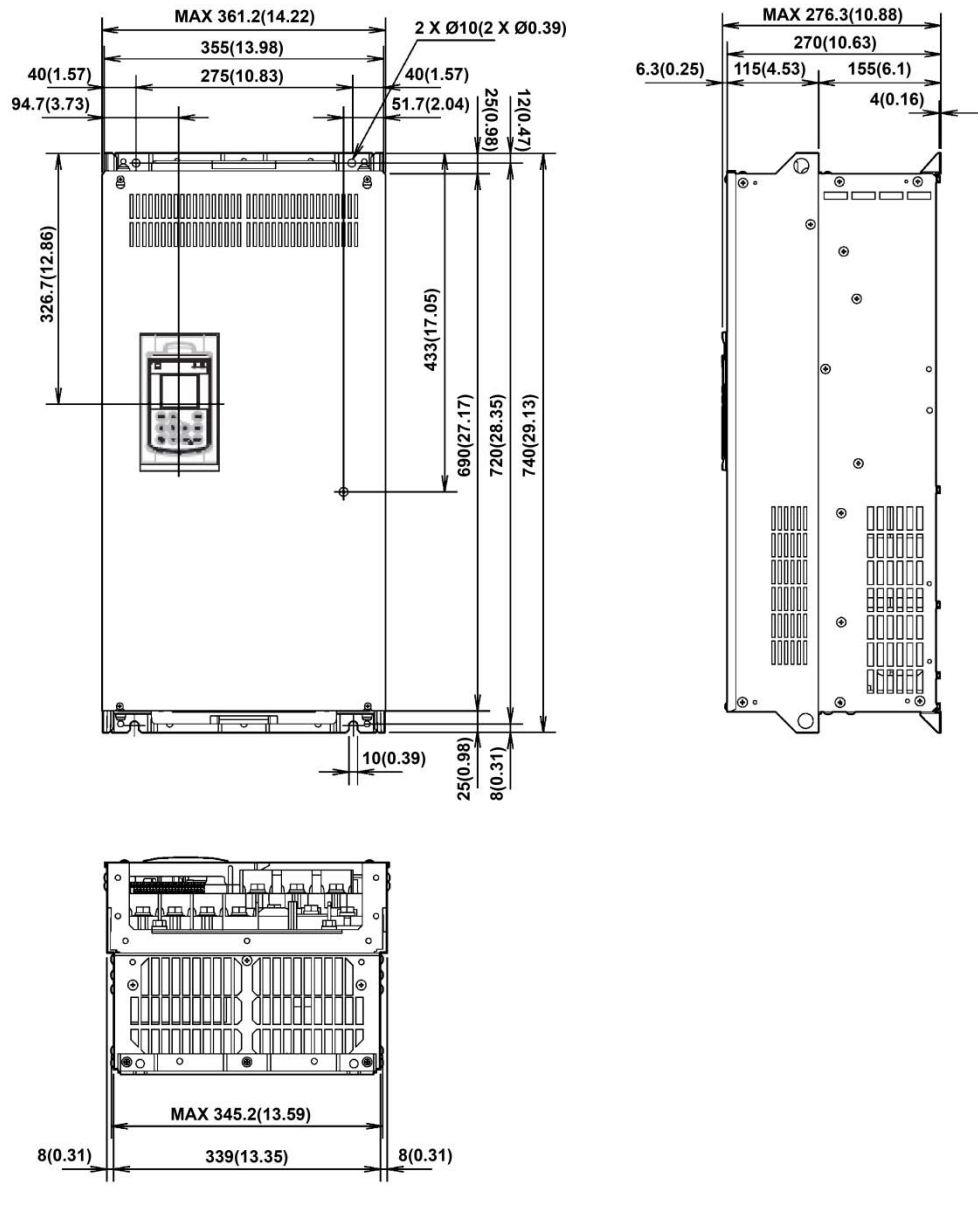

Figure 5 External Dimensions of the Inverter



Panel cutout

Figure 6 External Dimensions of the Inverter

FRN125AR1S-2U

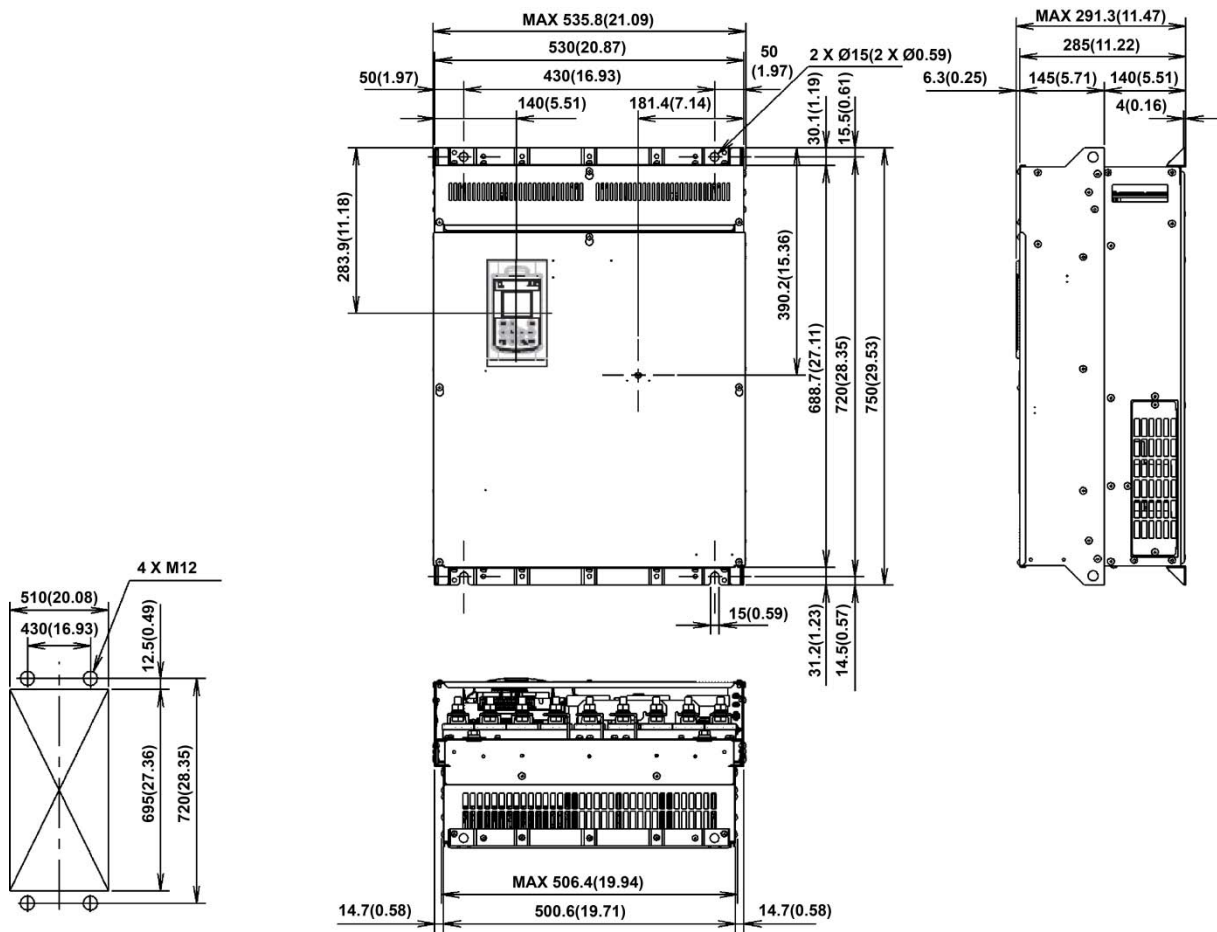

Panel cutout

Figure 7 External Dimensions of the Inverter

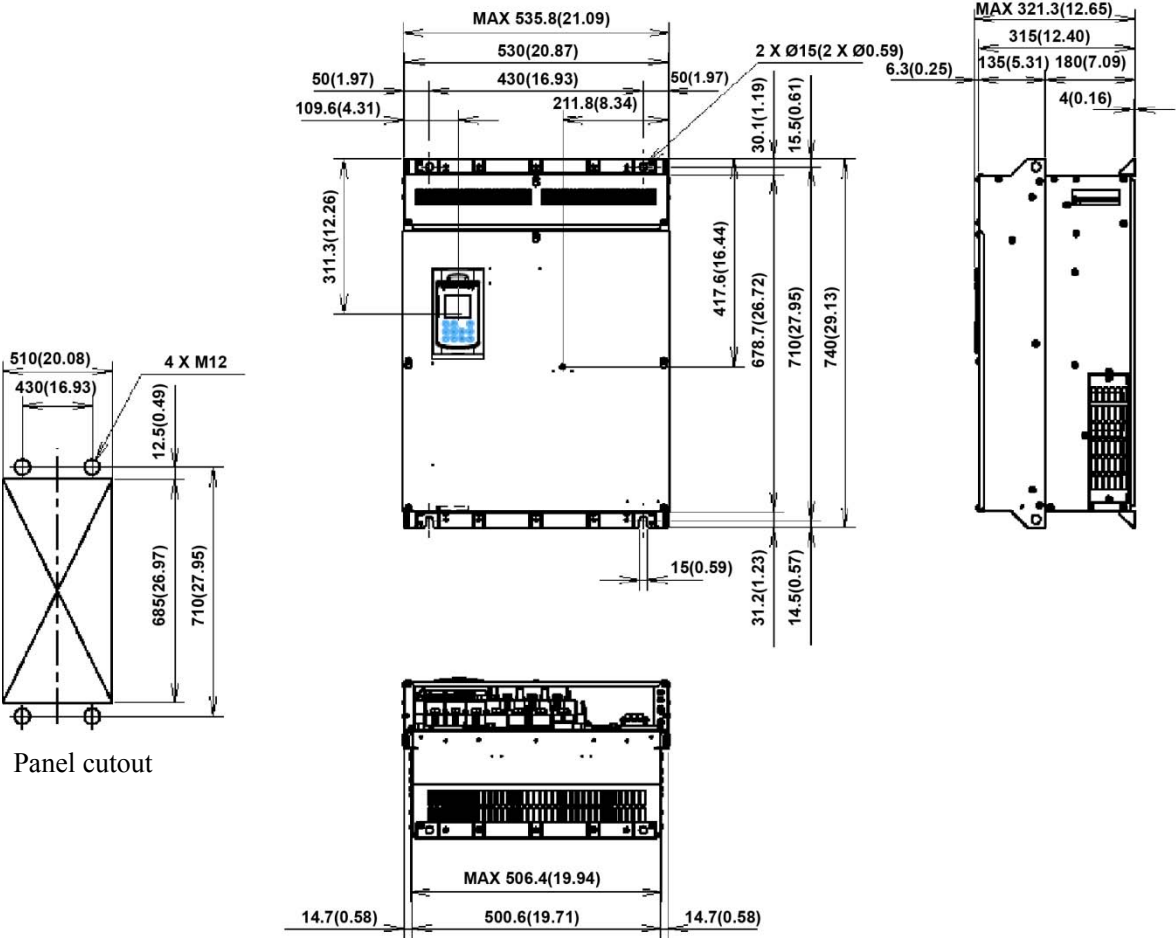

Figure 8 External Dimensions of the Inverter

FRN250AR1S-4U, FRN300AR1S-4U,
FRN200AR1S-5U, FRN300AR1S-5U

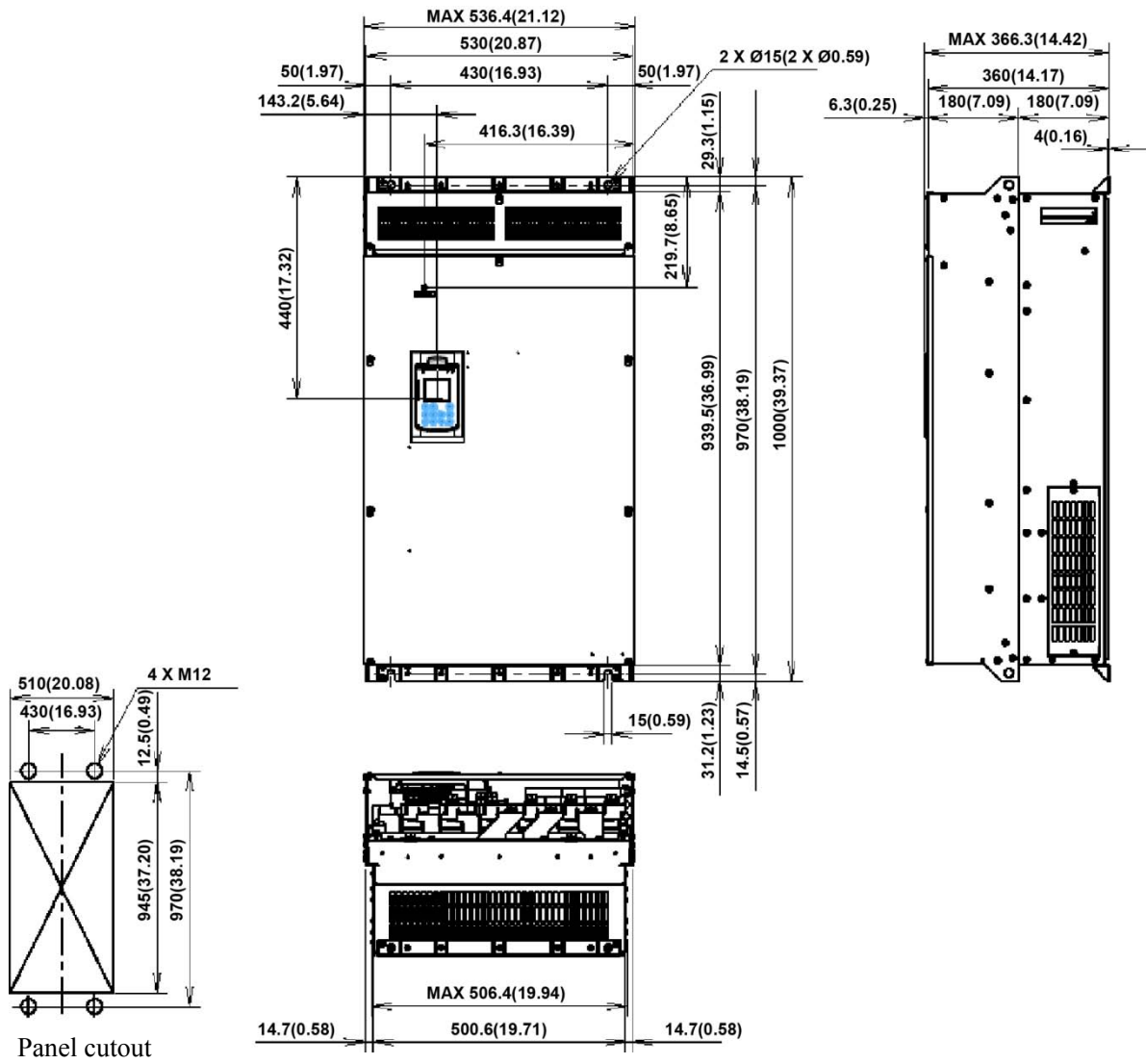

Figure 9 External Dimensions of the Inverter

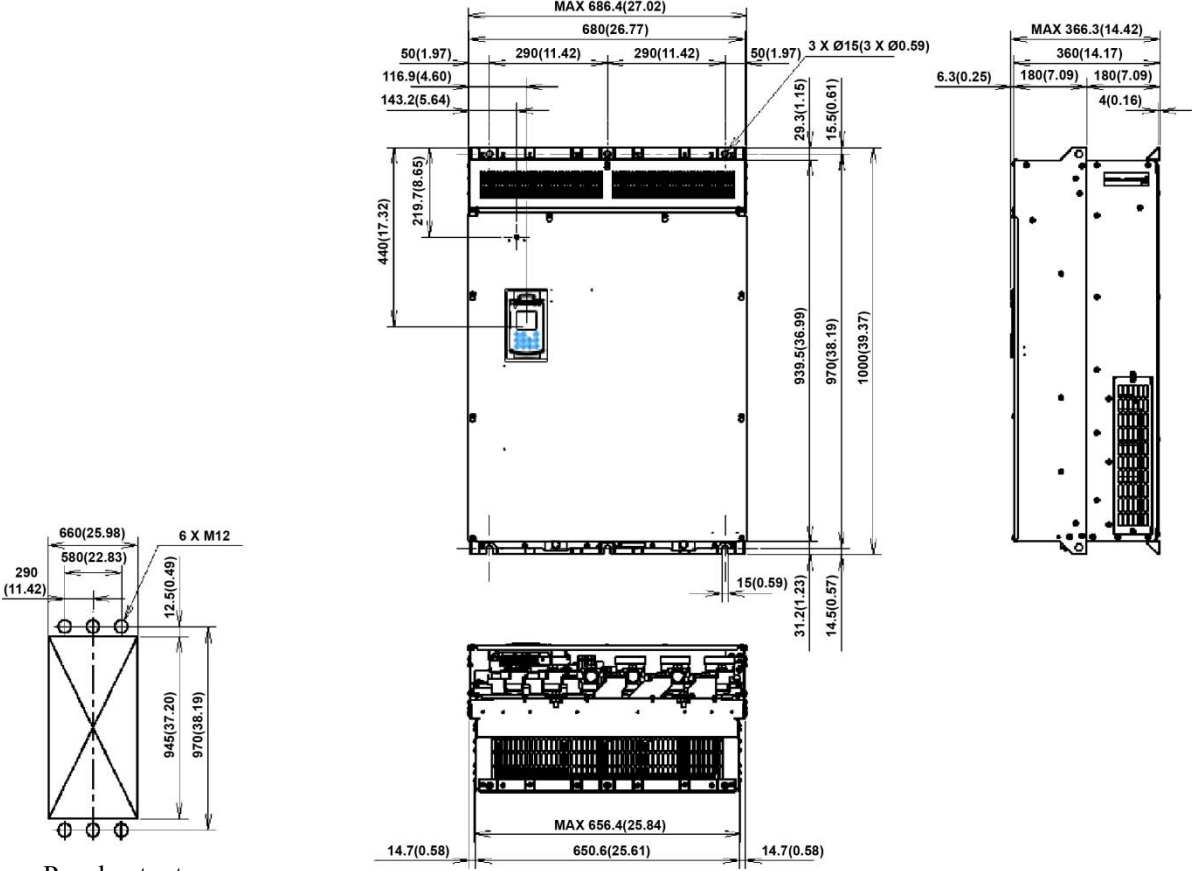
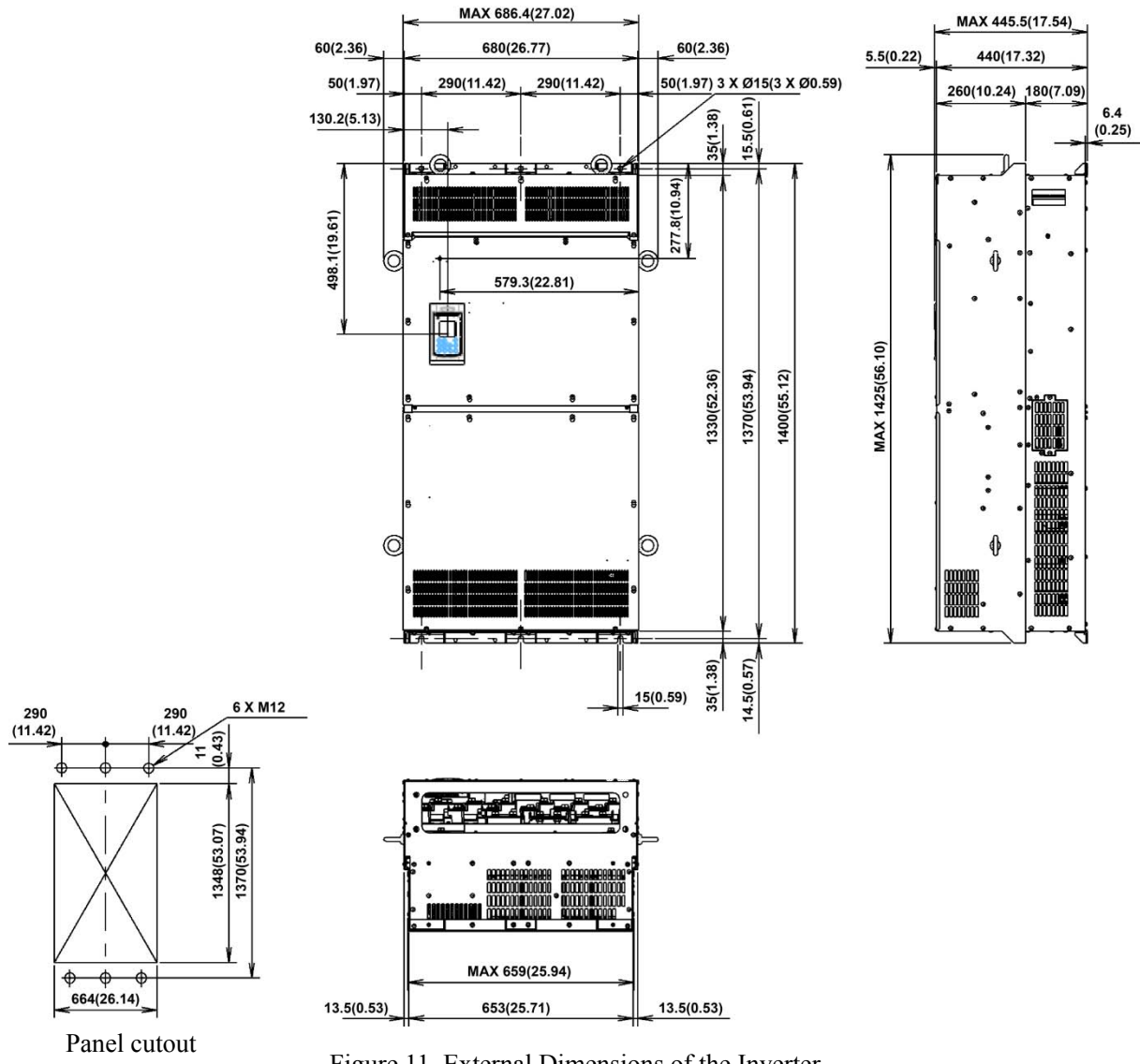
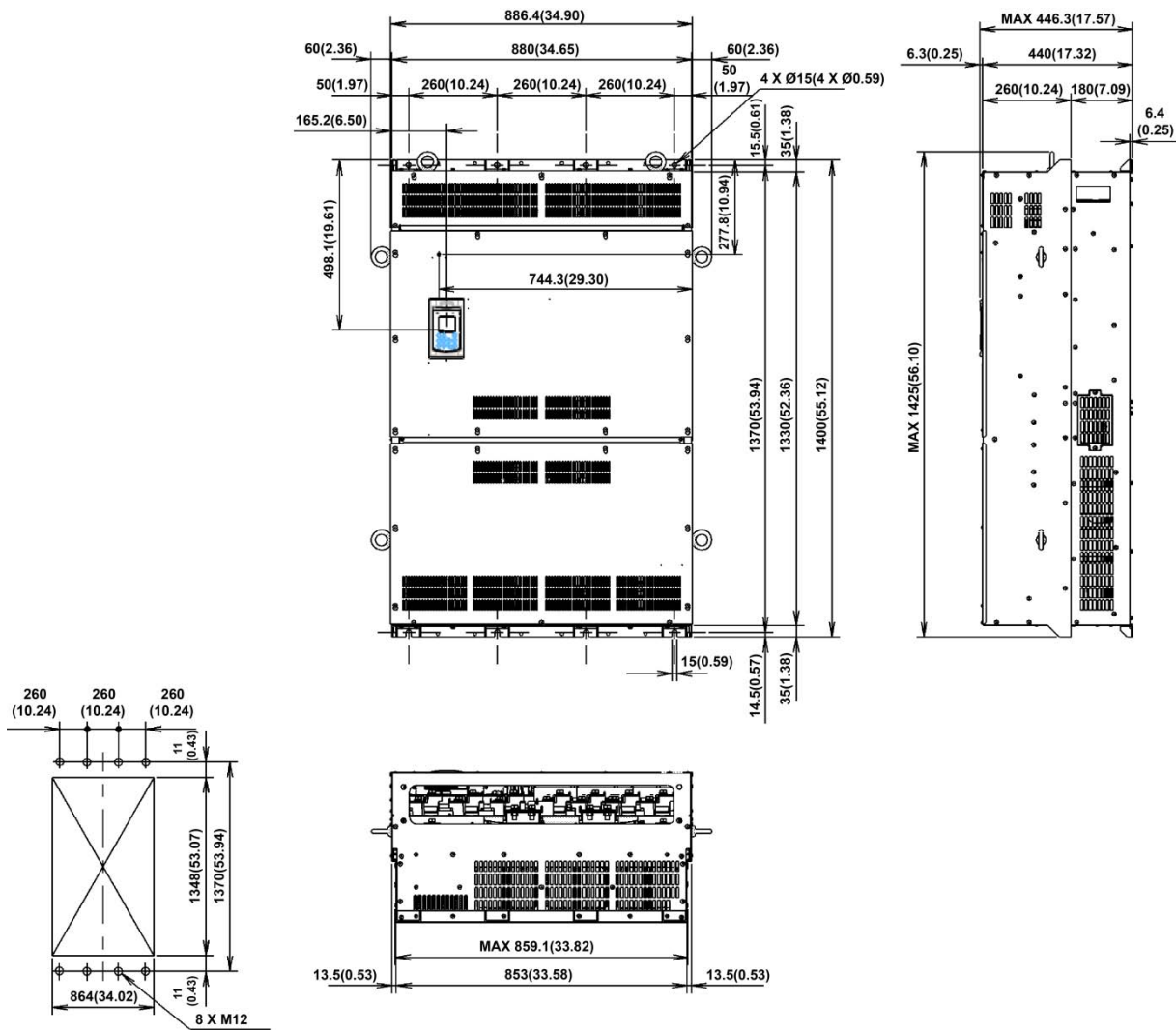

Figure 10 External Dimensions of the Inverter

FRN500AR1S-4U, FRN600AR1S-4U





Panel cutout

Figure 12 External Dimensions of the Inverter

FRN900AR1S-4U, FRN1000AR1S-4U

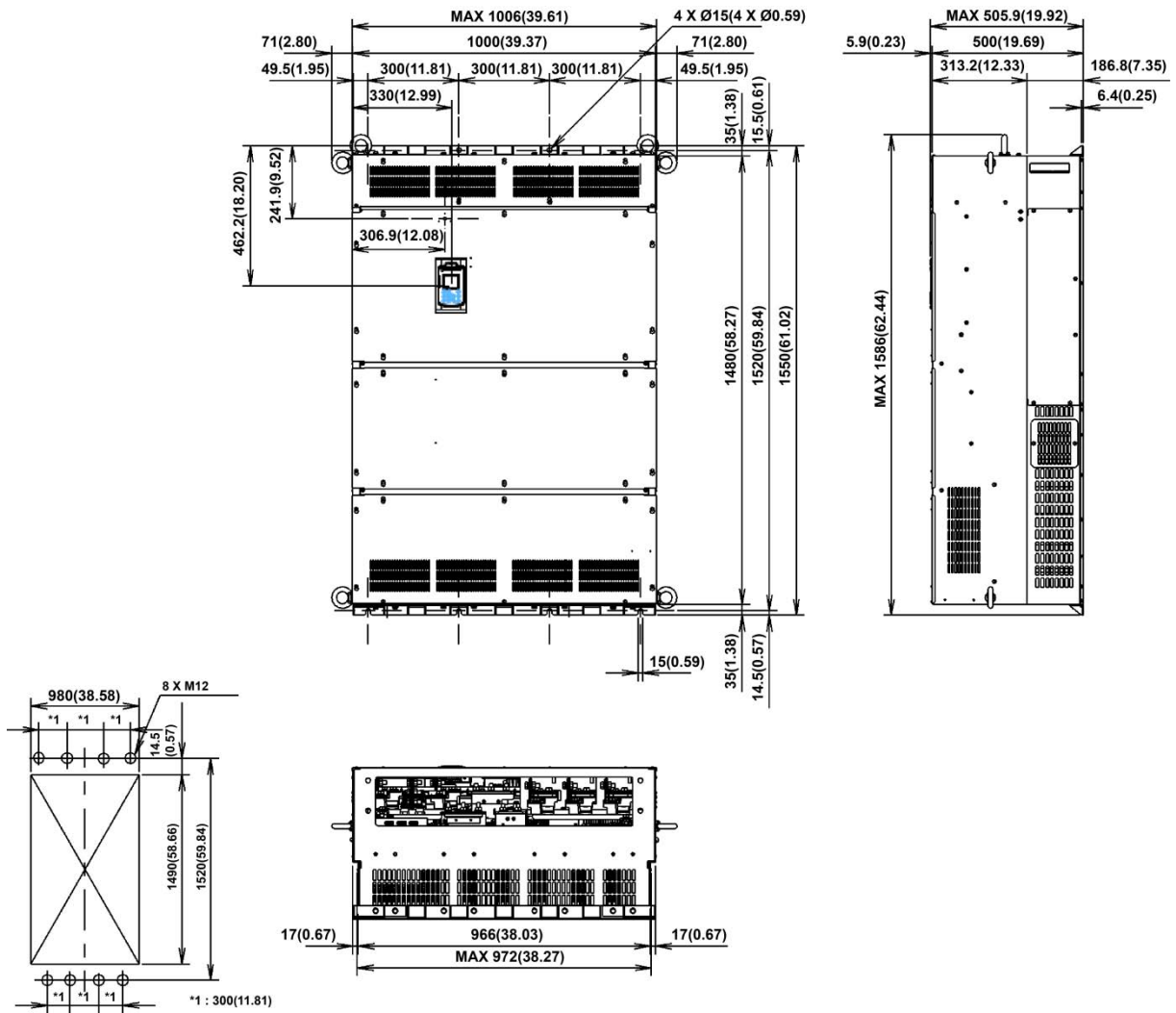

Panel cutout

Figure 13 External Dimensions of the Inverter

2.9.2 Keypad

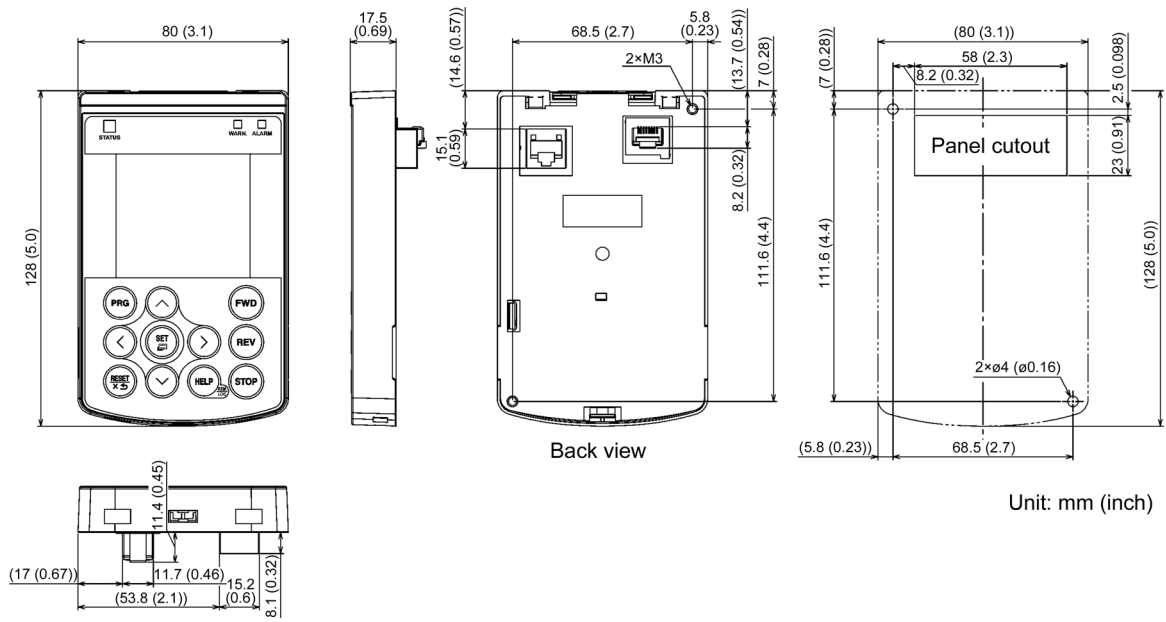

2.10 Connection Diagrams

[1] FRN060AR1-2U / FRN125AR1-4U / FRN150AR1-5U or below and

SINK mode input with Enable input function used (factory default)

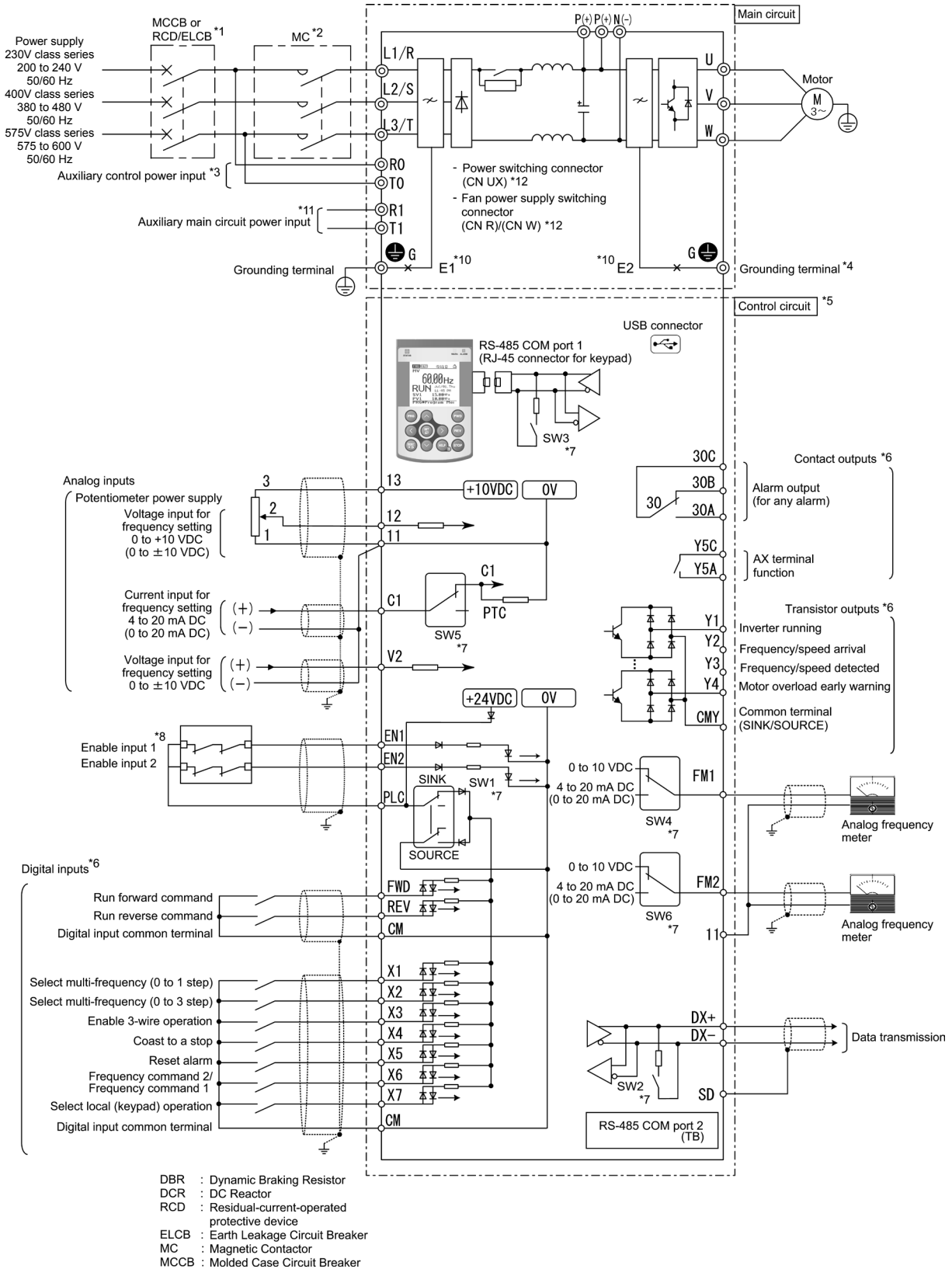

■ SOURCE mode input with Enable input function used

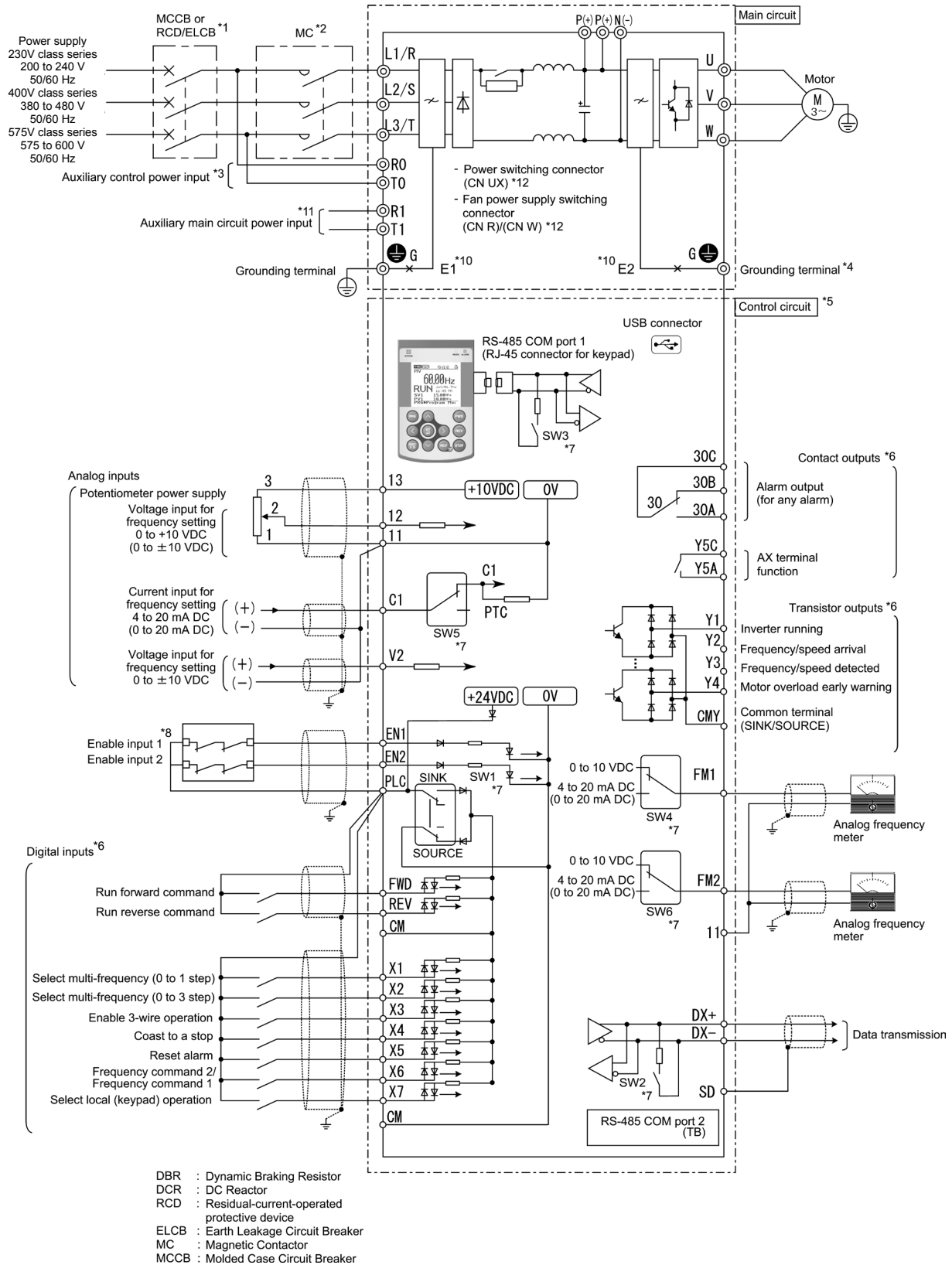

[2] FRN075AR1S-2U or above and FRN150AR1S-4U or above and FRN200AR1S-5U or above

■ SINK mode input with Enable input function used (factory default)

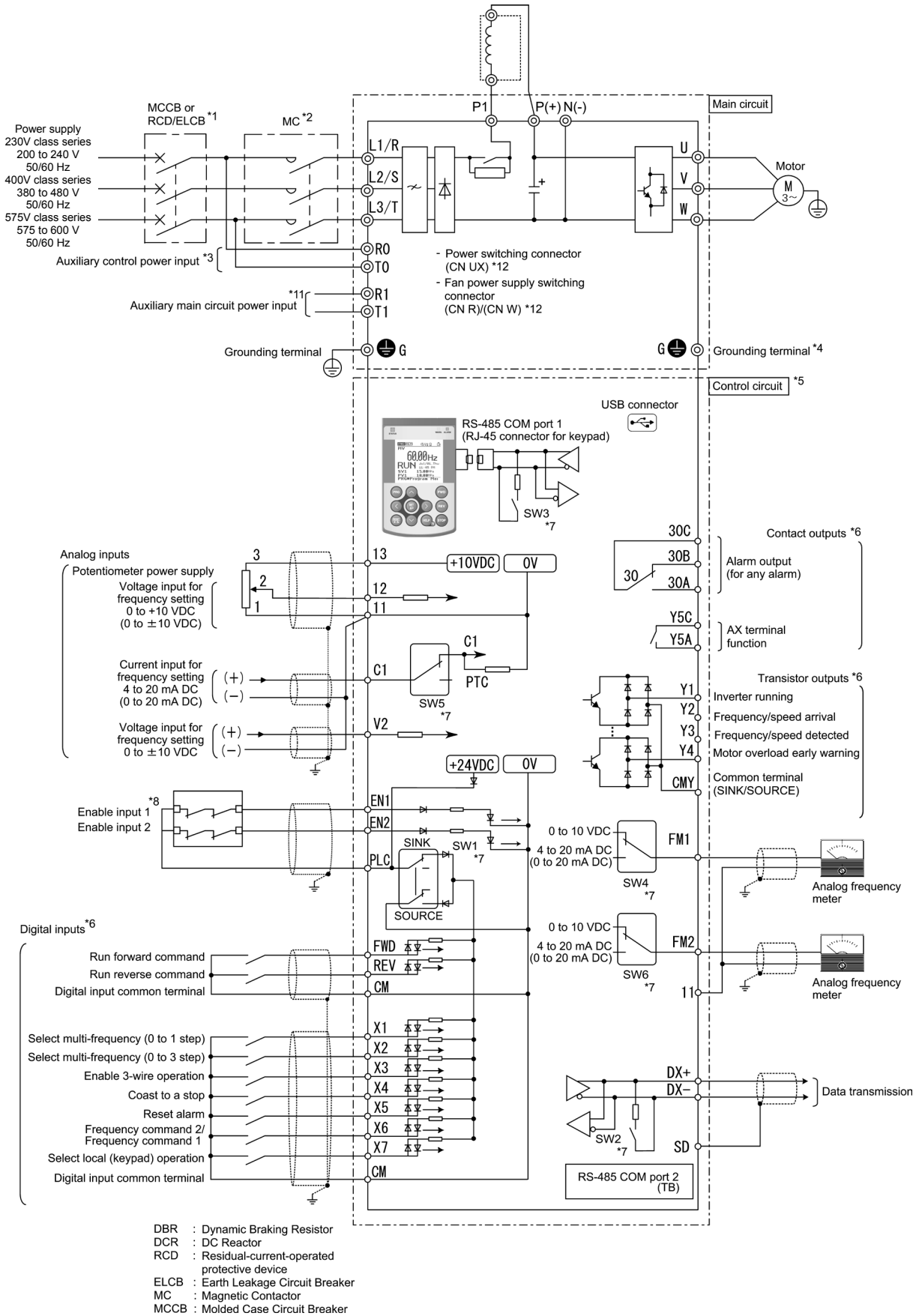

■ SOURCE mode input with Enable input function used

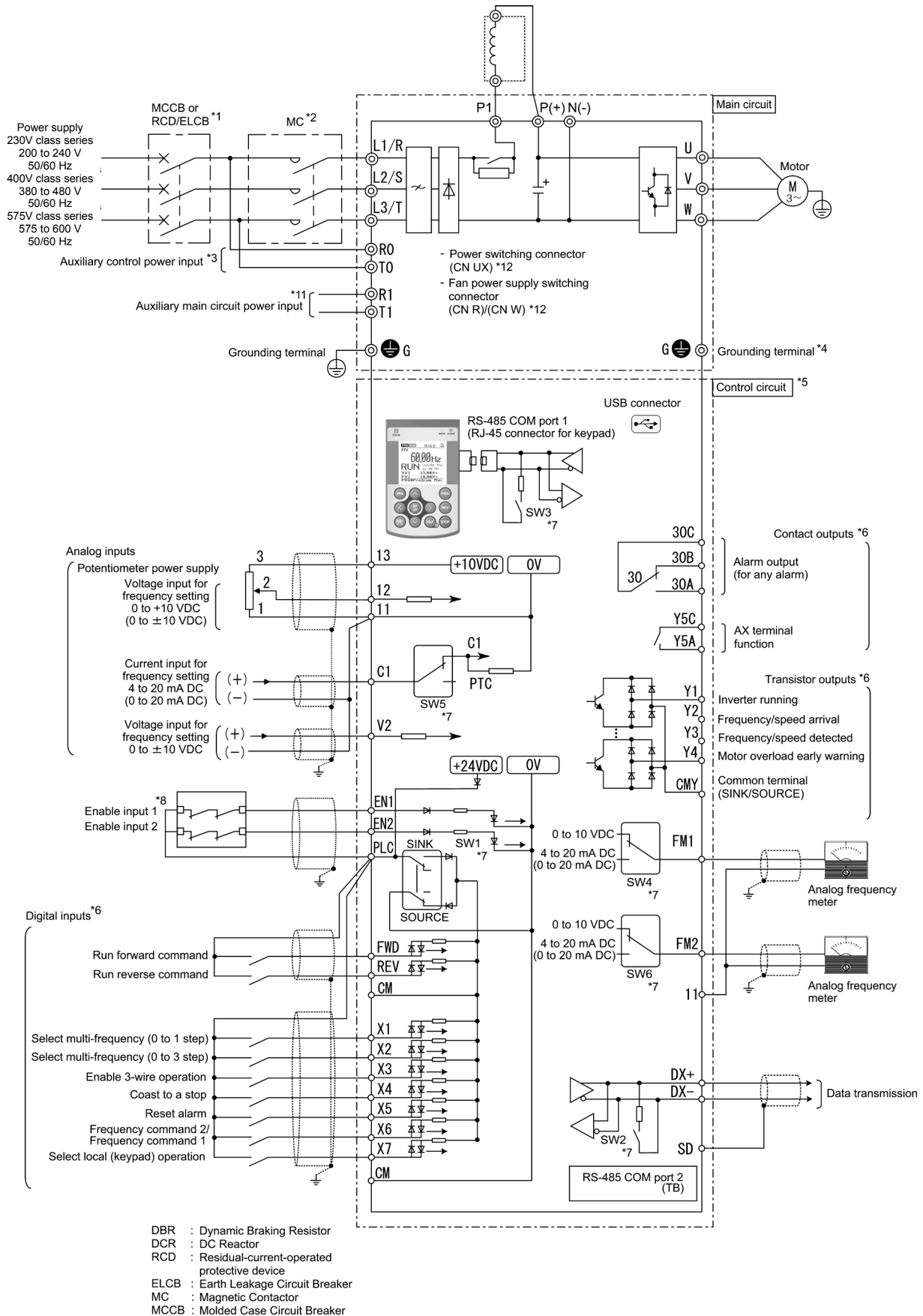

- *1 Install a recommended molded case circuit breaker (MCCB) or residual-current-operated protective device (RCD)/earth leakage circuit breaker (ELCB) (with overcurrent protection function) in the primary circuit of the inverter to protect wiring. Ensure that the circuit breaker capacity is equivalent to or lower than the recommended capacity.
- *2 Install a magnetic contactor (MC) for each inverter to separate the inverter from the power supply, apart from the MCCB or RCD/ELCB, when necessary. Connect a surge absorber in parallel when installing a coil such as the MC or solenoid near the inverter.
- *3 To retain an alarm output signal *ALM* issued on inverter's programmable output terminals by the protective function or to keep the keypad alive even if the main power has shut down, connect these terminals to the power supply lines. Even without power supply to these terminals, the inverter can run.
- *4 A grounding terminal for a motor. Use this terminal if needed.
- *5 For control signal wires, use twisted or shielded-twisted wires. When using shielded-twisted wires, connect the shield of them to the common terminals of the control circuit. To prevent malfunction due to noise, keep the control circuit wiring away from the main circuit wiring as far as possible (recommended: 10 cm or more). Never install them in the same wire duct. When crossing the control circuit wiring with the main circuit wiring, set them at right angles.
- *6 The connection diagram shows factory default functions assigned to digital input terminals [X1] to [X7], [FWD] and [REV], transistor output terminals [Y1] to [Y4], and relay contact output terminals [Y5A/C] and [30A/B/C].
- *7 Terminals [Y1] to [Y4] (transistor outputs) support both SINK and SOURCE modes. The diagrams below show the examples of circuit connection between the transistor output of the inverter's control circuit and a PLC.

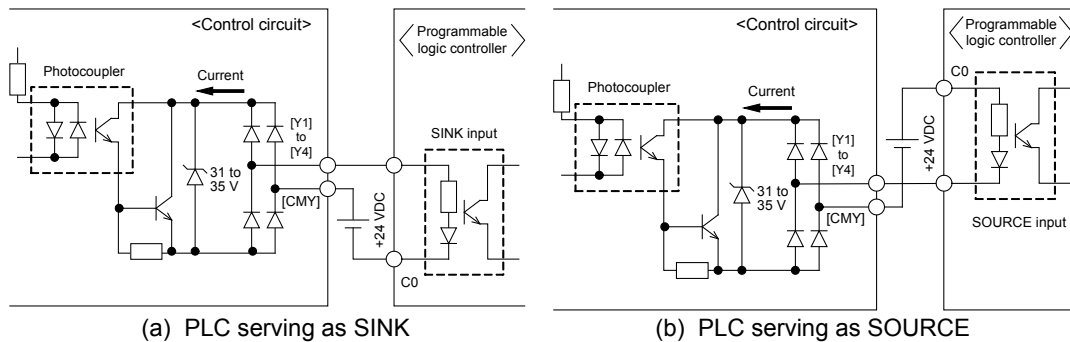

- *8 Slide switches on the control printed circuit board (control PCB). Use these switches to customize the inverter operations. For details, refer to Section 2.3.2 "Setting up the slide switches."
- *9 When the Enable function is not to be used, short-circuit terminals [EN1] and [PLC] and terminals [EN2] and [PLC] using jumper wires. For opening and closing the hardware circuit between terminals [EN1] and [PLC] and between [EN2] and [PLC], use safety components such as safety relays and safety switches. Be sure to use shielded wires exclusive to terminals [EN1] and [PLC] and terminals [EN2] and [PLC]. (Do not put them together with any other control signal wire in the same shielded core.)
- *10 (Missing number for FRN075AR1S-2U or above and FRN150AR1S-4U or above.)
Usually there is no need to do anything for the EMC filter.
When the leakage current from the connected EMC filter causes problems with the power supply system, removing screws from terminals [E1] and [E2] could improve the problem. Note that doing so loses the effect of the EMC filter so that the inverter is no longer compliant with the EMC standards. To remove those screws, consult your Fuji Electric representative.
- *11 Usually there is no need to do anything for these terminals. To be used when the inverter is combined with a power regenerative PWM converter (RHC series).
- *12 Main circuit switching connectors. For details, refer to Chapter 5, Section 5.1.6 "5.1.6 Wiring of main circuit terminals and grounding terminals."

Chapter 3

SELECTING OPTIMAL MOTOR AND INVERTER CAPACITIES

This chapter provides you with information about the inverter output torque characteristics, selection procedure, and equations for calculating capacities to help you select optimal motor and inverter models. It also helps you select braking resistors.

Contents

3.1	Selecting Motors and Inverters	3-1
3.1.1	Motor output torque characteristics.....	3-1
3.1.2	Selection procedure.....	3-3
3.1.3	Equations for selections	3-6
3.1.3.1	Load torque during constant speed running	3-6
3.1.3.2	Calculation of acceleration/deceleration time	3-7
3.1.3.3	Heat energy calculation of braking resistor	3-10

3.1 Selecting Motors and Inverters

When selecting a general-purpose inverter, first select a motor and then inverter as follows:

- (1) Key point for selecting a motor: Determine what kind of load machine is to be used, calculate its moment of inertia, and then select the appropriate motor capacity.
- (2) Key point for selecting an inverter: Taking into account the operation requirements (e.g., acceleration time, deceleration time, and frequency in operation) of the load machine to be driven by the motor selected in (1) above, calculate the acceleration/deceleration/braking torque.

This section describes the selection procedure for (1) and (2) above. First, it explains the output torque obtained by using the motor driven by the inverter (FRENIC-HVAC).

3.1.1 Motor output torque characteristics

Figures 3.1 and 3.2 graph the output torque characteristics of motors at the rated output frequency individually for 50 Hz and 60 Hz base. The horizontal and vertical axes show the output frequency and output torque (%), respectively. Curves (a) through (d) depend on the running conditions.

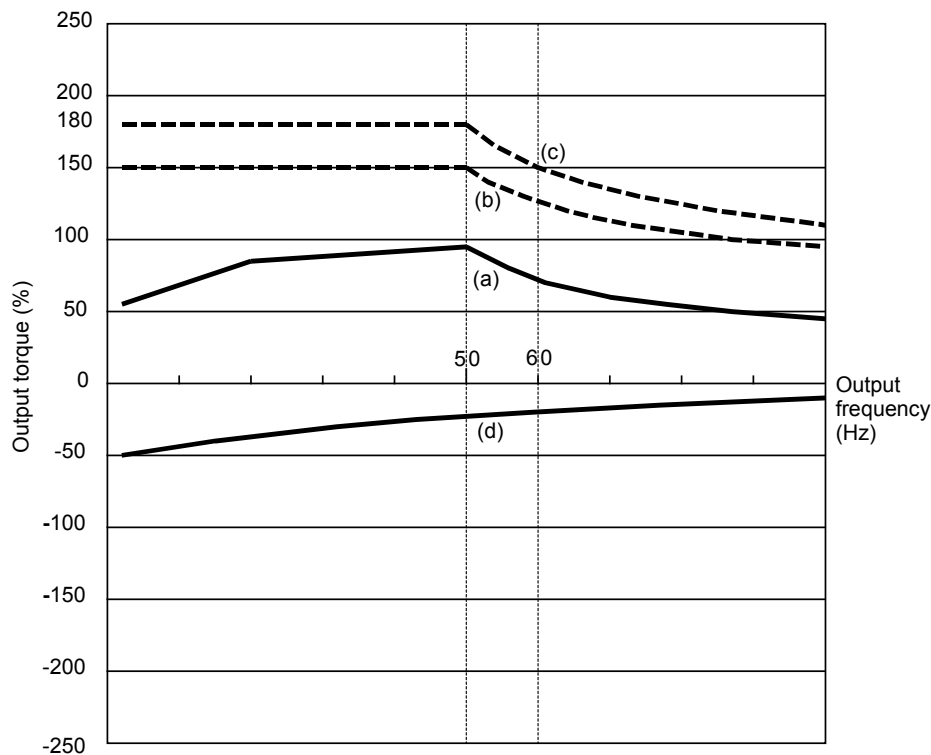

Figure 3.1 Output Torque Characteristics (Base frequency: 50 Hz)

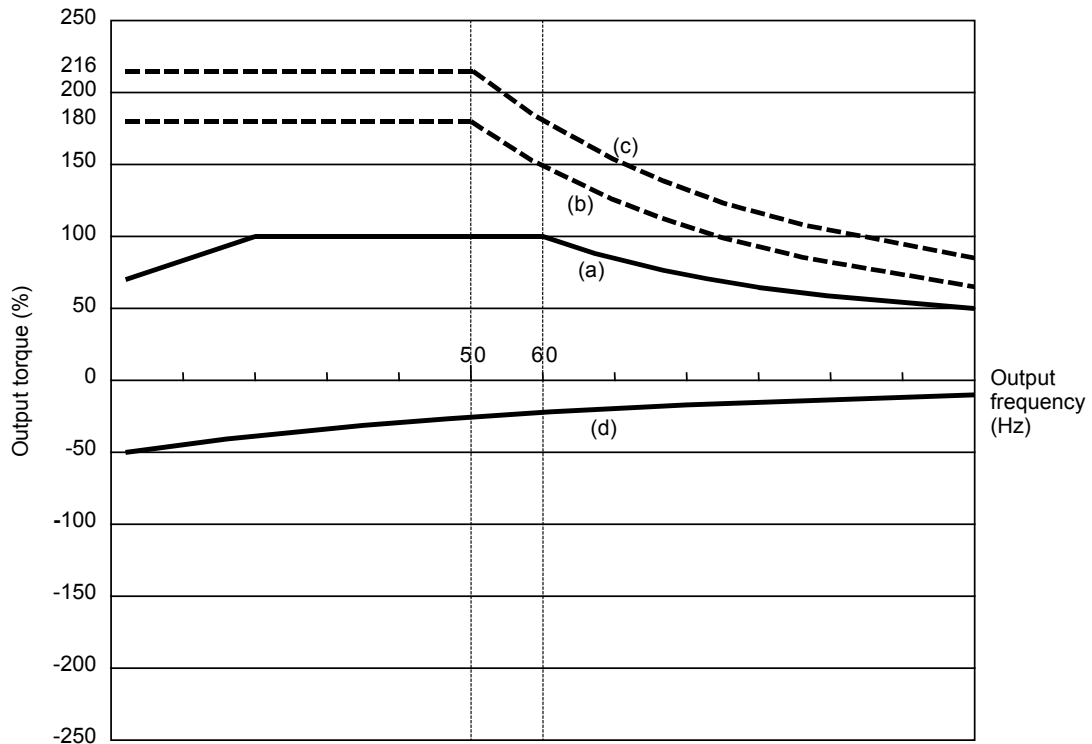

Figure 3.2 Output Torque Characteristics (Base frequency: 60 Hz)

(1) Continuous allowable driving torque (Curve (a) in Figures 3.1 and 3.2)

Curve (a) shows the torque characteristic that can be obtained in the range of the inverter continuous rated current, where the motor cooling characteristic is taken into consideration. When the motor runs at the base frequency of 60 Hz, 100 % output torque can be obtained; at 50 Hz, the output torque is somewhat lower than that in commercial power, and it further lowers at lower frequencies. The reduction of the output torque at 50 Hz is due to increased loss by inverter driving, and that at lower frequencies is mainly due to heat generation caused by the decreased ventilation performance of the motor cooling fan.

(2) Maximum driving torque in a short time (Curves (b) and (c) in Figures 3.1 and 3.2)

Curve (b) shows the torque characteristic that can be obtained in the range of the inverter rated current in a short time (the output torque is 110% for one minute) when dynamic torque-vector control ($F42 = 1$) is enabled. At that time, the motor cooling characteristics have little effect on the output torque.

Curve (c) shows an example of the torque characteristic when one class higher capacity inverter is used to increase the short-time maximum torque. In this case, the short-time torque is 20 to 30% greater than that when the standard capacity inverter is used.

(3) Starting torque (around the output frequency 0 Hz in Figures 3.1 and 3.2)

The maximum torque in a short time applies to the starting torque as it is.

(4) Braking torque (Curve (d) in Figures 3.1 and 3.2)

In braking of the motor, kinetic energy is converted to electrical energy and regenerated to the reservoir capacitor on the DC link bus of the inverter. Only the motor and inverter consume this energy as their internal losses, so the braking torque is as shown in curve (d).

Note that the torque value in % varies according to the inverter capacity.

3.1.2 Selection procedure

Figure 3.3 shows the general selection procedure for optimal inverters. Items numbered (1) through (3) are described on the following pages.

You may easily select inverter capacity if there are no restrictions on acceleration and deceleration times. If "there are any restrictions on acceleration or deceleration time" or "acceleration and deceleration are frequent," then the selection procedure is more complex than that of the constant speed running.

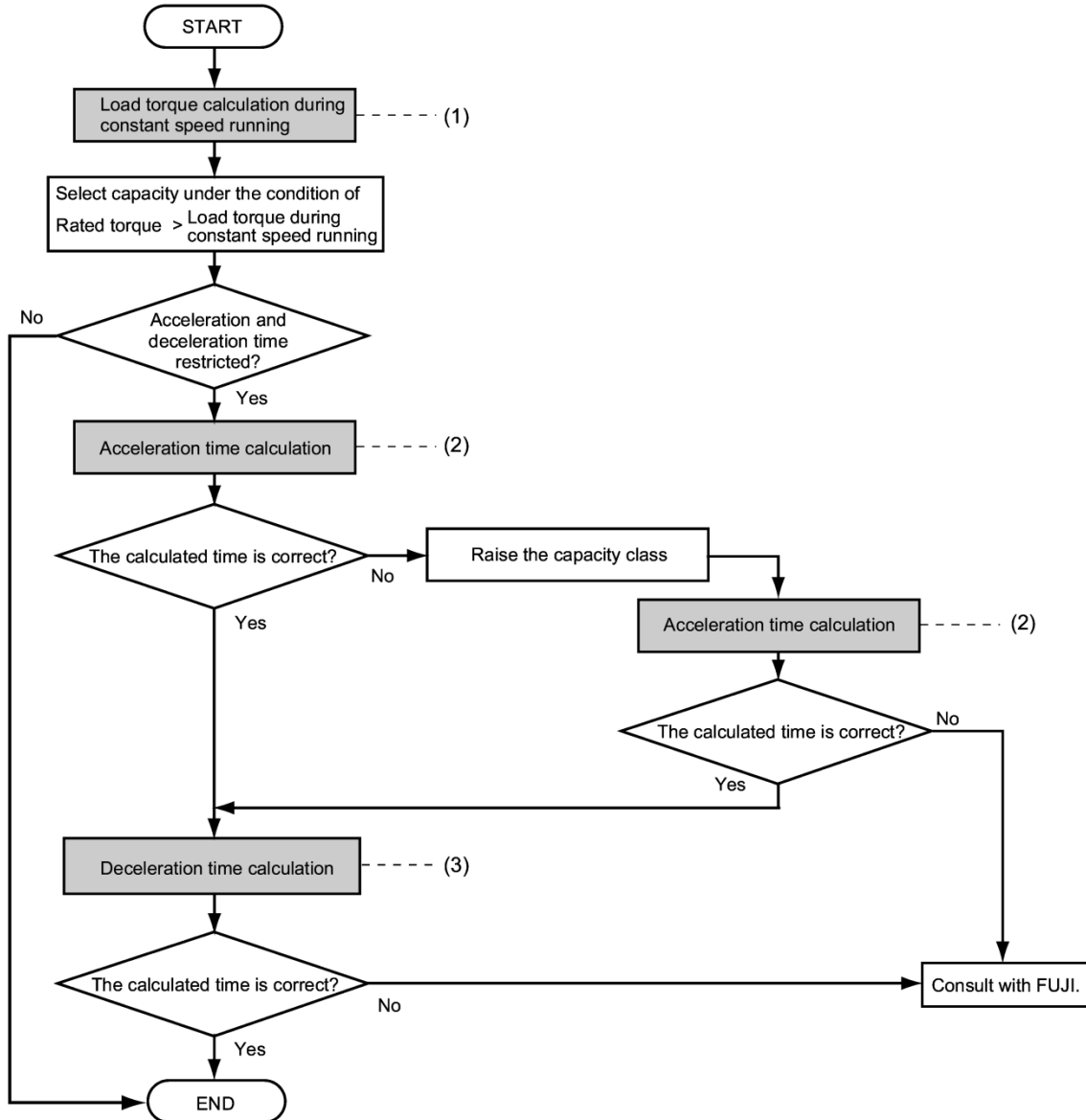

Figure 3.3 Selection Procedure

- (1) Calculating the load torque during constant speed running (For detailed calculation, refer to Section 3.1.3.1)

It is essential to calculate the load torque during constant speed running for all loads.

First calculate the load torque of the motor during constant speed running and then select a tentative capacity so that the continuous rated torque of the motor during constant speed running becomes higher than the load torque. To perform capacity selection efficiently, it is necessary to match the rated speeds (base speeds) of the motor and load. To do this, select an appropriate reduction-gear (mechanical transmission) ratio and the number of motor poles.

If the acceleration or deceleration time is not restricted, the tentative capacity can apply as a defined capacity.

- (2) Calculating the acceleration time (For detailed calculation, refer to Section 3.1.3.2)

When there are some specified requirements for the acceleration time, calculate it according to the following procedure:

- 1) Calculate the total moment of inertia for the load and motor
Calculate the moment of inertia for the load, referring to Section 3.1.3.2, "Calculation of acceleration/deceleration time." For the motor, refer to the related motor catalogs. Sum them up.
- 2) Calculate the required minimum acceleration torque (See Figure 3.4)
The acceleration torque is the difference between the motor short-time output torque (base frequency: 60 Hz) explained in Section 3.1.1 (2), "Maximum driving torque in a short time" and the load torque (τ_L / η_G) during constant speed running calculated in the above (1). Calculate the required minimum acceleration torque over the whole range of speed.
- 3) Calculate the acceleration time
Assign the value calculated above to the equation (3.10) in Section 3.1.3.2, "Calculation of acceleration/deceleration time" to calculate the acceleration time. If the calculated acceleration time is longer than the expected time, select the inverter and motor having one class higher capacity and calculate it again.

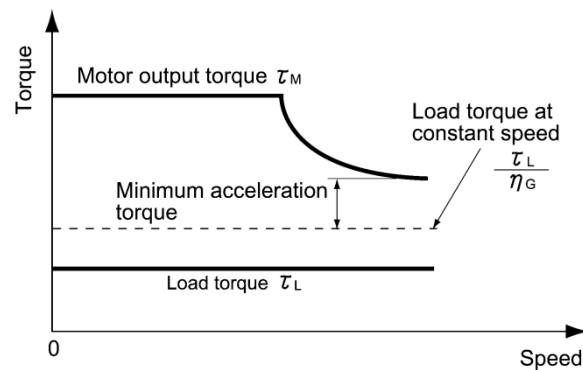

Figure 3.4 Example Study of Minimum Acceleration Torque

(3) Deceleration time (For detailed calculation, refer to Section 3.1.3.2)

To calculate the deceleration time, check the motor deceleration torque characteristics for the whole range of speed in the same way as for the acceleration time.

- 1) Calculate the total moment of inertia for the load and motor
Same as for the acceleration time.
- 2) Calculate the required minimum deceleration torque (See Figures 3.5 and 3.6.)
Same as for the acceleration time.
- 3) Calculate the deceleration time
Assign the value calculated above to the equation (3.11) to calculate the deceleration time in the same way as for the acceleration time. If the calculated deceleration time is longer than the requested time, select the inverter and motor having one class higher capacity and calculate it again.

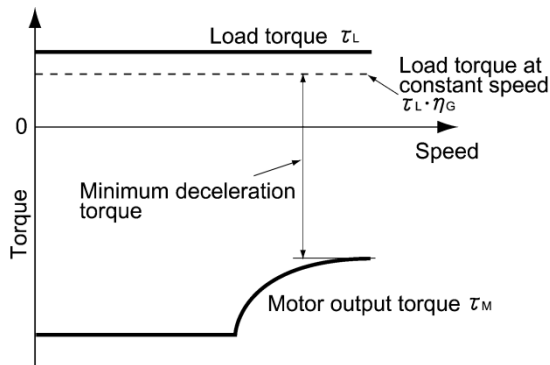

Figure 3.5 Example Study of Minimum Deceleration Torque (1)

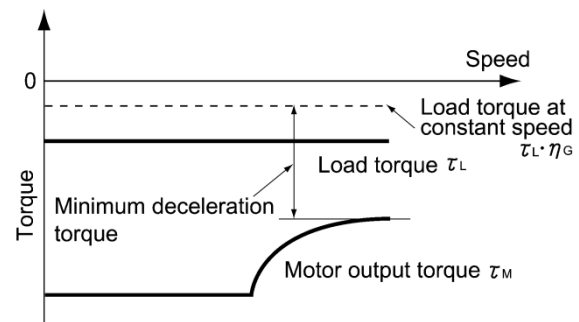

Figure 3.6 Example Study of Minimum Deceleration Torque (2)

3.1.3 Equations for selections

3.1.3.1 Load torque during constant speed running

[1] General equation

The frictional force acting on a horizontally moved load must be calculated. Calculation for driving a load along a straight line with the motor is shown below.

Where the force to move a load linearly at constant speed v (m/s) is F (N) and the motor speed for driving this is N_M (r/min), the required motor output torque τ_M (N·m) is as follows:

$$\tau_M = \frac{60 \cdot v}{2 \pi \cdot N_M} \cdot \frac{F}{\eta_G} \quad (\text{N} \cdot \text{m}) \quad (3.1)$$

where, η_G is Reduction-gear efficiency.

When the inverter brakes the motor, efficiency works inversely, so the required motor torque should be calculated as follows:

$$\tau_M = \frac{60 \cdot v}{2 \pi \cdot N_M} \cdot F \cdot \eta_G \quad (\text{N} \cdot \text{m}) \quad (3.2)$$

$(60 \cdot v) / (2 \pi \cdot N_M)$ in the above equation is an equivalent turning radius corresponding to speed v (m/s) around the motor shaft.

The value F (N) in the above equations depends on the load type.

[2] Obtaining the required force F

Moving a load horizontally

A simplified mechanical configuration is assumed as shown in Figure 3.7. If the mass of the carrier table is W_0 (kg), the load is W (kg), and the friction coefficient of the ball screw is μ , then the friction force F (N) is expressed as follows, which is equal to a required force for driving the load:

$$F = (W_0 + W) \cdot g \cdot \mu \quad (\text{N}) \quad (3.3)$$

where, g is the gravity acceleration (≈ 9.8 (m/s²)).

Then, the driving torque around the motor shaft is expressed as follows:

$$\tau_M = \frac{60 \cdot v}{2 \pi \cdot N_M} \cdot \frac{(W_0 + W) \cdot g \cdot \mu}{\eta_G} \quad (\text{N} \cdot \text{m}) \quad (3.4)$$

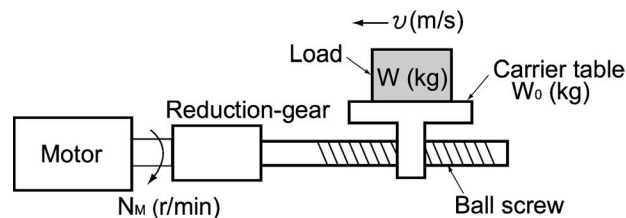

Figure 3.7 Moving a Load Horizontally

3.1.3.2 Calculation of acceleration/deceleration time

When an object whose moment of inertia is J ($\text{kg}\cdot\text{m}^2$) rotates at the speed N (r/min), it has the following kinetic energy:

$$E = \frac{J}{2} \cdot \left(\frac{2\pi \cdot N}{60} \right)^2 \quad (\text{J}) \quad (3.5)$$

To accelerate the above rotational object, the kinetic energy will be increased; to decelerate the object, the kinetic energy must be discharged. The torque required for acceleration and deceleration can be expressed as follows:

$$\tau = J \cdot \frac{2\pi}{60} \left(\frac{dN}{dt} \right) \quad (\text{N}\cdot\text{m}) \quad (3.6)$$

This way, the mechanical moment of inertia is an important element in the acceleration and deceleration. First, calculation method of moment of inertia is described, then those for acceleration and deceleration time are explained.

[1] Calculation of moment of inertia

For an object that rotates around the shaft, virtually divide the object into small segments and square the distance from the shaft to each segment. Then, sum the squares of the distances and the masses of the segments to calculate the moment of inertia.

$$J = \sum (W_i \cdot r_i^2) \quad (\text{kg}\cdot\text{m}^2) \quad (3.7)$$

The following describes equations to calculate moment of inertia having different shaped loads or load systems.

(1) Hollow cylinder and solid cylinder

The common shape of a rotating body is hollow cylinder. The moment of inertia J ($\text{kg}\cdot\text{m}^2$) around the hollow cylinder center axis can be calculated as follows, where the outer and inner diameters are D_1 and D_2 [m] and total mass is W [kg] in Figure 3.8.

$$J = \frac{W \cdot (D_1^2 + D_2^2)}{8} \quad (\text{kg}\cdot\text{m}^2) \quad (3.8)$$

For a similar shape, a solid cylinder, calculate the moment of inertia as D_2 is 0.

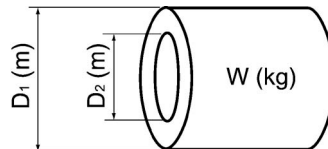
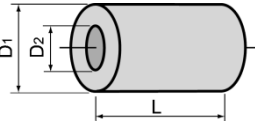
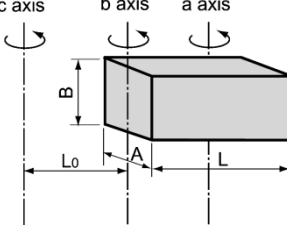
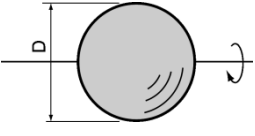
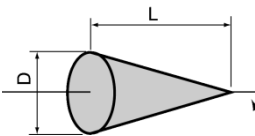
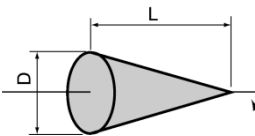
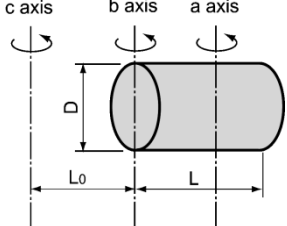
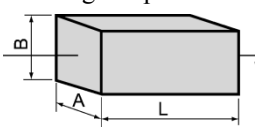
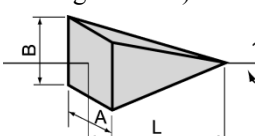
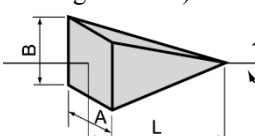
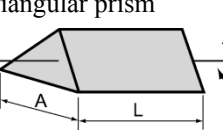
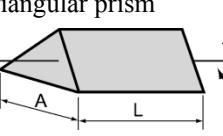
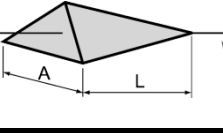
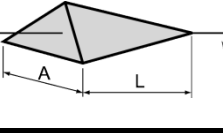

Figure 3.8 Hollow Cylinder

(2) For a general rotating body

Table 3.1 lists the calculation equations of moment of inertia of various rotating bodies including the above cylindrical rotating body.

Table 3.1 Moment of Inertia of Various Rotating Bodies

Shape	Mass: W (kg) Moment of inertia: J (kg·m ²)	Shape	Mass: W (kg) Moment of inertia: J (kg·m ²)
Hollow cylinder 	$W = \frac{\pi}{4} \cdot (D_1^2 - D_2^2) \cdot L \cdot \rho$ $J = \frac{1}{8} \cdot W \cdot (D_1^2 + D_2^2)$		$W = A \cdot B \cdot L \cdot \rho$ $J_a = \frac{1}{12} \cdot W \cdot (L^2 + A^2)$ $J_b = \frac{1}{12} \cdot W \cdot (L^2 + \frac{1}{4} \cdot A^2)$ $J_c \approx W \cdot (L_0^2 + L_0 \cdot L + \frac{1}{3} \cdot L^2)$
Sphere 	$W = \frac{\pi}{6} \cdot D^3 \cdot \rho$ $J = \frac{1}{10} \cdot W \cdot D^2$		$W = \frac{\pi}{4} \cdot D^2 \cdot L \cdot \rho$ $J_a = \frac{1}{12} \cdot W \cdot (L^2 + \frac{3}{4} \cdot D^2)$ $J_b = \frac{1}{3} \cdot W \cdot (L^2 + \frac{3}{16} \cdot D^2)$ $J_c \approx W \cdot (L_0^2 + L_0 \cdot L + \frac{1}{3} \cdot L^2)$
Cone 	$W = \frac{\pi}{12} \cdot D^2 \cdot L \cdot \rho$ $J = \frac{3}{40} \cdot W \cdot D^2$		$W = \frac{\pi}{3} \cdot A \cdot B \cdot L \cdot \rho$ $J_b = \frac{1}{10} \cdot W \cdot (L^2 + \frac{1}{4} \cdot A^2)$ $J_c \approx W \cdot (L_0^2 + \frac{3}{2} \cdot L_0 \cdot L + \frac{3}{5} \cdot L^2)$
Rectangular prism 	$W = A \cdot B \cdot L \cdot \rho$ $J = \frac{1}{12} \cdot W \cdot (A^2 + B^2)$		$W = \frac{\pi}{12} \cdot D^2 \cdot L \cdot \rho$ $J_b = \frac{1}{10} \cdot W \cdot (L^2 + \frac{3}{8} \cdot D^2)$ $J_c \approx W \cdot (L_0^2 + \frac{3}{2} \cdot L_0 \cdot L + \frac{3}{5} \cdot L^2)$
Square cone (Pyramid, rectangular base) 	$W = \frac{1}{3} \cdot A \cdot B \cdot L \cdot \rho$ $J = \frac{1}{20} \cdot W \cdot (A^2 + B^2)$		$W = \frac{\pi}{12} \cdot D^2 \cdot L \cdot \rho$ $J_b = \frac{1}{10} \cdot W \cdot (L^2 + \frac{3}{8} \cdot D^2)$ $J_c \approx W \cdot (L_0^2 + \frac{3}{2} \cdot L_0 \cdot L + \frac{3}{5} \cdot L^2)$
Triangular prism 	$W = \frac{\sqrt{3}}{4} \cdot A^2 \cdot L \cdot \rho$ $J = \frac{1}{3} \cdot W \cdot A^2$		$W = \frac{\pi}{12} \cdot D^2 \cdot L \cdot \rho$ $J_b = \frac{1}{10} \cdot W \cdot (L^2 + \frac{3}{8} \cdot D^2)$ $J_c \approx W \cdot (L_0^2 + \frac{3}{2} \cdot L_0 \cdot L + \frac{3}{5} \cdot L^2)$
Tetrahedron with an equilateral triangular base 	$W = \frac{\sqrt{3}}{12} \cdot A^2 \cdot L \cdot \rho$ $J = \frac{1}{5} \cdot W \cdot A^2$	Main metal density (at 20°C(68°F)) ρ(kg/m ³) Iron: 7860, Copper: 8940, Aluminum: 2700	

(3) For a load running horizontally

Assume a carrier table driven by a motor as shown in Figure 3.7. If the table speed is v (m/s) when the motor speed is N_M (r/min), then an equivalent distance from the shaft is equal to $60 \cdot v / (2\pi \cdot N_M)$ (m). The moment of inertia of the table and load to the shaft is calculated as follows:

$$J = \left(\frac{60 \cdot v}{2\pi \cdot N_M} \right)^2 \cdot (W_0 + W) \quad (\text{kg} \cdot \text{m}^2) \quad (3.9)$$

[2] Calculation of the acceleration time

Figure 3.9 shows a general load model. Assume that a motor drives a load via a reduction-gear with efficiency η_G . The time required to accelerate this load in stop state to a speed of N_M (r/min) is calculated with the following equation:

$$t_{\text{ACC}} = \frac{J_1 + J_2/\eta_G}{\tau_M - \tau_L/\eta_G} \cdot \frac{2\pi \cdot (N_M - 0)}{60} \quad (\text{s}) \quad (3.10)$$

where,

J_1 : Motor shaft moment of inertia ($\text{kg} \cdot \text{m}^2$)

J_2 : Load shaft moment of inertia converted to motor shaft ($\text{kg} \cdot \text{m}^2$)

τ_M : Minimum motor output torque in driving motor ($\text{N} \cdot \text{m}$)

τ_L : Maximum load torque converted to motor shaft ($\text{N} \cdot \text{m}$)

η_G : Reduction-gear efficiency.

As clarified in the above equation, the equivalent moment of inertia becomes $(J_1 + J_2/\eta_G)$ by considering the reduction-gear efficiency.

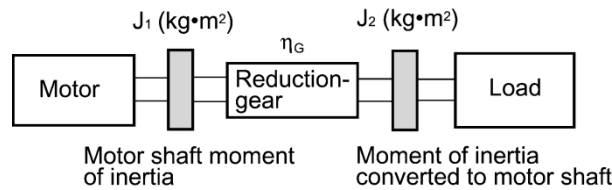

Figure 3.9 Load Model Including Reduction-gear

[3] Calculation of the deceleration time

In a load system shown in Figure 3.9, the time needed to stop the motor rotating at a speed of N_M (r/min) is calculated with the following equation:

$$t_{\text{DEC}} = \frac{J_1 + J_2 \cdot \eta_G}{\tau_M - \tau_L \cdot \eta_G} \cdot \frac{2\pi \cdot (0 - N_M)}{60} \quad (\text{s}) \quad (3.11)$$

where,

J_1 : Motor shaft moment of inertia ($\text{kg} \cdot \text{m}^2$)

J_2 : Load shaft moment of inertia converted to motor shaft ($\text{kg} \cdot \text{m}^2$)

τ_M : Minimum motor output torque in braking (or decelerating) motor ($\text{N} \cdot \text{m}$)

τ_L : Maximum load torque converted to motor shaft ($\text{N} \cdot \text{m}$)

η_G : Reduction-gear efficiency

In the above equation, generally output torque τ_M is negative and load torque τ_L is positive. So, deceleration time becomes shorter.

3.1.3.3 Heat energy calculation of braking resistor

If the inverter brakes the motor, the kinetic energy of mechanical load is converted to electric energy to be transmitted into the inverter circuit. This regenerative energy is often consumed in so-called braking resistors as heat. The following explains the braking resistor rating.

[1] Calculation of regenerative energy

In the inverter operation, one of the regenerative energy sources is the kinetic energy that is generated at the time an object is moved by an inertial force.

Kinetic energy of a moving object

When an object with moment of inertia J ($\text{kg}\cdot\text{m}^2$) rotates at a speed N_2 (r/min), its kinetic energy is as follows:

$$E = \frac{J}{2} \cdot \left(\frac{2\pi \cdot N_2}{60} \right)^2 \quad (J = \text{Ws}) \quad (3.12)$$

$$\approx \frac{1}{182.4} \cdot J \cdot N_2^2 \quad (J) \quad (3.12)'$$

When this object is decelerated to a speed N_1 (r/min), the output energy is as follows:

$$E = \frac{J}{2} \cdot \left[\left(\frac{2\pi \cdot N_2}{60} \right)^2 - \left(\frac{2\pi \cdot N_1}{60} \right)^2 \right] \quad (J) \quad (3.13)$$

$$\approx \frac{1}{182.4} \cdot J \cdot (N_2^2 - N_1^2) \quad (J) \quad (3.13)'$$

The energy regenerated to the inverter as shown in Figure 3.9 is calculated from the reduction-gear efficiency η_G and motor efficiency η_M as follows:

$$E \approx \frac{1}{182.4} \cdot (J_1 + J_2 \cdot \eta_G) \cdot \eta_M \cdot (N_2^2 - N_1^2) \quad (J) \quad (3.14)$$

[2] Calculation of energy able to regenerate per inverter

Energy able to regenerate per inverter is determined by the power source voltage and capacitance of the DC link bus capacitor(s).

$$E_c = \frac{1}{2} \cdot C \cdot V^2 \quad (J) \quad (3.15)$$

If the value E obtained by the equation (3.14) does not exceed the value E_c obtained here, the inverter is able to decelerate its load.

Chapter 4

SELECTING PERIPHERAL EQUIPMENT

This chapter describes how to use a range of peripheral equipment and options, FRENIC-HVAC's configuration with them, and requirements and precautions for selecting wires and crimp terminals.

Contents

4.1	Configuring the FRENIC-HVAC	4-1
4.2	Currents flowing across the inverter terminals	4-2
4.3	Peripheral Equipment	4-5
4.3.1	Molded case circuit breaker (MCCB), residual-current-operated protective device (RCD)/ earth leakage circuit breaker (ELCB) and magnetic contactor (MC)	4-5
4.3.2	Surge killers for L-load	4-10
4.3.3	Arresters	4-11
4.3.4	Surge absorbers	4-12
4.4	Options	4-13
4.4.1	Selecting peripheral equipment options	4-13
4.4.1.1	Power regenerative PWM converters, RHC series	4-13
4.4.1.2	AC reactors (ACRs)	4-36
4.4.1.3	DC reactors (DCRs) (Built-in or bundled as standard)	4-41
4.4.1.4	Surge suppression unit (SSU)	4-43
4.4.1.5	Output circuit filters (OFLs)	4-44
4.4.1.6	Zero-phase reactors for reducing radio noise (ACLs)	4-48
4.4.2	Selecting options for operation and communication	4-49
4.4.2.1	External frequency command potentiometer	4-49
4.4.2.2	Extension cable for remote operation	4-50
4.4.2.3	Frequency meters	4-50
4.4.2.4	Inverter support loader software	4-51
4.4.3	Selecting Option Cards	4-52
4.4.3.1	List of option cards, connection ports, and applicable ROM versions	4-52
4.4.3.2	Relay output interface card (OPC-RY)	4-53
4.4.3.3	Relay output interface card (OPC-RY2)	4-55
4.4.3.4	Analog interface card (OPC-AIO)	4-57
4.4.3.5	Analog current output (2 ch) interface card (OPC-AO)	4-61
4.4.3.6	Resistance temperature detector input card (OPC-PT)	4-63
4.4.3.7	CC-Link communications card (OPC-CCL)	4-66
4.4.3.8	PROFIBUS-DP communications card (OPC-PDP2)	4-68
4.4.3.9	DeviceNet communications card (OPC-DEV)	4-71
4.4.3.10	CANopen communications card (OPC-COP)	4-74
4.4.3.11	LONWORKS communications card (OPC-LNW)	4-76
4.4.3.12	Ethernet communications card (OPC-ETH)	4-77

4.5 Backup Battery.....	4-79
4.5.1 Outline.....	4-79
4.5.2 Loading the battery	4-80
4.5.3 Battery replacement procedure.....	4-82
4.5.4 About air transport of batteries.....	4-82

4.1 Configuring the FRENIC-HVAC

This section lists the names and features of peripheral equipment and options for the FRENIC-HVAC series of inverters and includes a configuration example for reference.

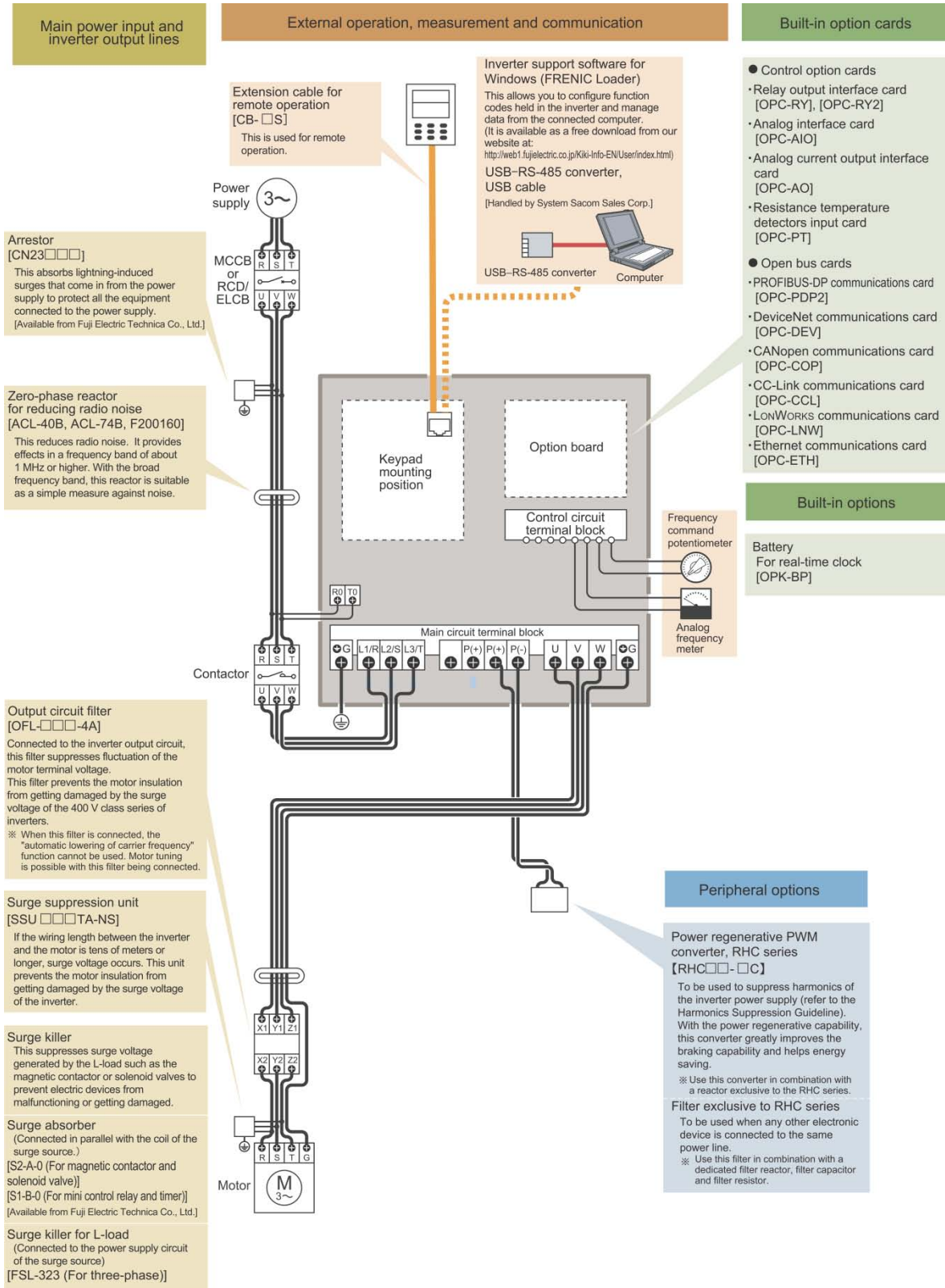

Figure 4.1 Configuration Example

4.2 Currents flowing across the inverter terminals

Table 4.1 summarizes average (effective) electric currents flowing across the terminals of each inverter model for ease of reference when you select peripheral equipment and options.

Table 4.1 Currents Flowing through Inverter

Power supply voltage	Nominal applied motor (HP)	Inverter type	60 Hz, 230 V	
			Input RMS current (A)	DC link bus current (A)
Three-phase 230 V	1	FRN001AR1■-2U	2.8	3.5
	2	FRN002AR1■-2U	5.3	6.5
	3	FRN003AR1■-2U	7.5	9.2
	5	FRN005AR1■-2U	12.9	15.8
	7.5	FRN007AR1■-2U	18.0	22.1
	10	FRN010AR1■-2U	24.2	29.7
	15	FRN015AR1■-2U	36.0	44.1
	20	FRN020AR1■-2U	48.6	59.6
	25	FRN025AR1■-2U	60.0	73.5
	30	FRN030AR1■-2U	71.5	87.6
	40	FRN040AR1■-2U	96.9	119
	50	FRN050AR1■-2U	121	149
	60	FRN060AR1■-2U	145	178
	75	FRN075AR1S-2U	177	217
	100	FRN100AR1S-2U	246	302
125	FRN125AR1S-2U	291	357	

Note: A box (■) replaces an alphabetic letter depending on the enclosure.
M (NEMA/UL TYPE 1) or L (NEMA/UL TYPE 12)

Note: The input RMS current values listed in the above table apply when the inverter is connected with a power supply of 230 V, 60 Hz, $R_{sce} = 120$.

If the power supply voltage differs from 230 V, such as 200 V, the input RMS current values will vary in inverse proportion to the voltage.

Table 4.1 Currents Flowing through Inverter (continued)

Power supply voltage	Nominal applied motor (HP)	Inverter type	460 V, 60 Hz	
			Input RMS current (A)	DC link bus current (A)
Three-phase 460 V	1	FRN001AR1■-4U	1.4	1.8
	2	FRN002AR1■-4U	2.7	3.4
	3	FRN003AR1■-4U	3.8	4.7
	5	FRN005AR1■-4U	6.5	8.0
	7.5	FRN007AR1■-4U	9.0	11.1
	10	FRN010AR1■-4U	12.1	14.9
	15	FRN015AR1■-4U	18.0	22.1
	20	FRN020AR1■-4U	24.3	29.8
	25	FRN025AR1■-4U	30.0	36.8
	30	FRN030AR1■-4U	35.8	43.9
	40	FRN040AR1■-4U	48.5	59.5
	50	FRN050AR1■-4U	60.4	74.0
	60	FRN060AR1■-4U	72.3	88.6
	75	FRN075AR1■-4U	88.7	109
	100	FRN100AR1■-4U	119	146
	125	FRN125AR1■-4U	141	173
	150	FRN150AR1S-4U	175	215
	200	FRN200AR1S-4U	207	254
	250	FRN250AR1S-4U	249	305
	300	FRN300AR1S-4U	311	381
350	FRN350AR1S-4U	340	417	
450	FRN450AR1S-4U	435	533	
500	FRN500AR1S-4U	547	670	
600	FRN600AR1S-4U	614	752	
800	FRN800AR1S-4U	767	940	
900	FRN900AR1S-4U	970	1189	
1000	FRN1000AR1S-4U	1093	1339	

Note: A box (■) replaces an alphabetic letter depending on the enclosure.
M (NEMA/UL TYPE 1) or L (NEMA/UL TYPE 12)

Note: The input RMS current values listed in the above table apply when the inverter is connected with a power supply of 460 V, 60 Hz, $R_{sc} = 120$.

If the power supply voltage differs from 460 V, such as 380 V, the input RMS current values will vary in inverse proportion to the voltage.

Table 4.1 Currents Flowing through Inverter (continued)

Power supply voltage	Nominal applied motor (HP)	Inverter type	575 V, 60 Hz	
			Input RMS current (A)	DC link bus current (A)
Three-phase 575 V	1	FRN001AR1■-5U	1.2	1.5
	2	FRN002AR1■-5U	2.1	2.6
	3	FRN003AR1■-5U	3.0	3.7
	5	FRN005AR1■-5U	5.2	6.4
	7.5	FRN007AR1■-5U	7.2	8.8
	10	FRN010AR1■-5U	9.7	12
	15	FRN015AR1■-5U	14.4	18
	20	FRN020AR1■-5U	19.5	24
	25	FRN025AR1■-5U	24.0	29
	30	FRN030AR1■-5U	28.6	35
	40	FRN040AR1■-5U	38.8	48
	50	FRN050AR1■-5U	48.3	59
	60	FRN060AR1■-5U	57.9	71
	75	FRN075AR1■-5U	71.0	87
	100	FRN100AR1■-5U	94.7	116
	125	FRN125AR1■-5U	113	138
	150	FRN150AR1■-5U	140	172
	200	FRN200AR1S-5U	199	244
250	FRN250AR1S-5U	249	305	
300	FRN300AR1S-5U	272	333	

Note: A box (■) replaces an alphabetic letter depending on the enclosure.
M (NEMA/UL TYPE 1) or L (NEMA/UL TYPE 12)

Note: The input RMS current values listed in the above table apply when the inverter is connected with a power supply of 575 V, 60 Hz, R_{sce} = 120.

4.3 Peripheral Equipment

4.3.1 Molded case circuit breaker (MCCB), residual-current-operated protective device (RCD)/earth leakage circuit breaker (ELCB) and magnetic contactor (MC)

[1] Functional overview

MCCBs and RCDs/ELCBs*

* With overcurrent protection

Molded Case Circuit Breakers (MCCBs) are designed to protect the power circuits between the power supply and inverter's main circuit terminals ([L1/R], [L2/S] and [L3/T]) from overload or short-circuit, which in turn prevents secondary accidents caused by the broken inverter.

Residual-Current-Operated Protective Devices (RCDs)/Earth Leakage Circuit Breakers (ELCBs) function in the same way as MCCBs.

Built-in overcurrent/overload protective functions protect the inverter itself from failures related to its input/output lines.





MCs

An MC can be used at both the power input and output sides of the inverter. At each side, the MC works as described below. When inserted in the output circuit of the inverter, the MC can also switch the motor drive power supply between the inverter output and commercial power lines.

At the power supply side

Insert an MC in the power supply side of the inverter in order to:

- (1) Forcibly cut off the inverter from the power supply (generally, commercial/factory power lines) with the protective function built into the inverter, or with the external signal input.
- (2) Stop the inverter operation in an emergency when the inverter cannot interpret the stop command due to internal/external circuit failures.
- (3) Cut off the inverter from the power supply when the MCCB inserted in the power supply side cannot cut it off for maintenance or inspection purpose. For the purpose only, it is recommended that you use an MC capable of turning the MC ON/OFF manually.

 **Note** Avoid frequent ON/OFF operation of the magnetic contactor (MC) in the input circuit; otherwise, the inverter failure may result. The frequency of the MC's ON/OFF should not be more than once per 30 minutes. To assure 10-year or longer service life of the inverter, it should not be more than once per hour. If frequent start/stop of the motor is required, use **FWD/REV** terminal signals or the ,  and  keys on the inverter's keypad.

At the output side

Insert an MC in the power output side of the inverter in order to:

- (1) Prevent externally turned-around current from being applied to the inverter power output terminals ([U], [V], and [W]) unexpectedly. An MC should be used, for example, when a circuit that switches the motor driving power supply between the inverter output and commercial power lines is connected to the inverter.

 **Tip** If a magnetic contactor (MC) is inserted in the inverter's output (secondary) circuit for switching the motor to a commercial power or for any other purposes, it should be switched on and off when both the inverter and motor are completely stopped. This prevents the contact point from getting rough due to a switching arc of the MC. The MC should not be equipped with any main circuit surge killer (Fuji SZ-ZM□, etc.). Applying a commercial power to the inverter's output circuit breaks the inverter. To avoid it, interlock the MC on the motor's commercial power line with the one in the inverter output circuit so that they are not switched ON at the same time.

- (2) Drive more than one motor selectively by a single inverter.
- (3) Selectively cut off the motor whose thermal overload relay or equivalent devices have been activated.

Driving the motor using commercial power lines

MCs can also be used to switch the power supply of the motor driven by the inverter to a commercial power supply.

Select the MC so as to satisfy the rated currents listed in Table 4.1, which are the most critical RMS currents for using the inverter. (Refer to Table 4.4.)

[2] Connection example and criteria for selection of circuit breakers

Figure 4.2 shows a connection example for MCCB or RCD/ELCB (with overcurrent protection) and MC in the inverter input circuit. Table 4.4 lists the rated current for the MCCB and corresponding inverter models. Table 4.5 lists the applicable grades of RCD/ELCB sensitivity.

⚠ WARNING
Insert an MCCB or RCD/ELCB (with overcurrent protection) recommended for each inverter for its input circuits. Do not use an MCCB or RCD/ELCB of a higher rating than that recommended. Doing so could result in a fire.

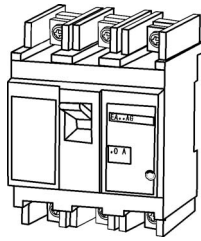

Molded case circuit breaker or residual-current-operated protective device/earth leakage circuit breaker

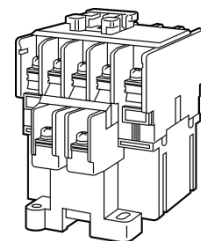

Magnetic contactor

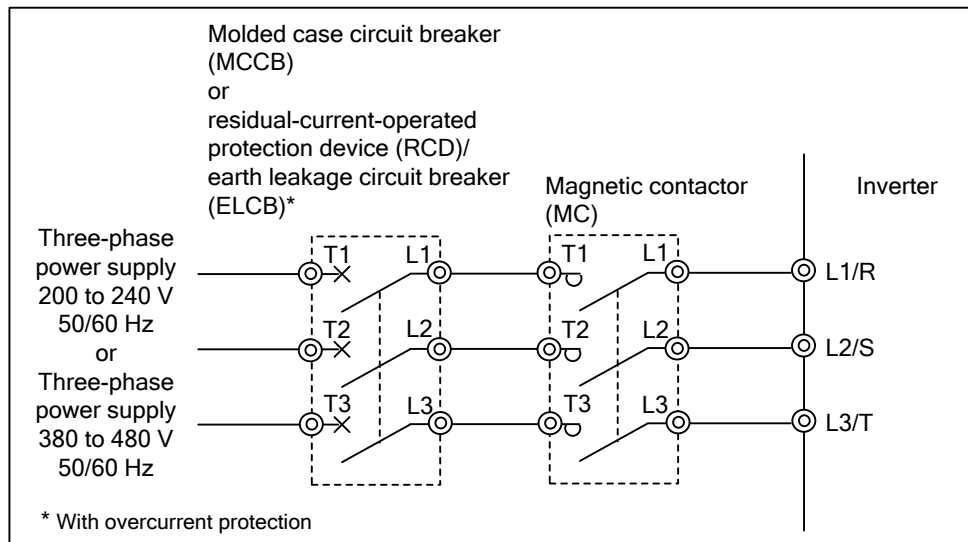

Figure 4.2 External Views of MCCB or RCD/ELCB and MC and Connection Example

Table 4.4 Rated Current of Molded Case Circuit Breaker (MCCB), Residual-Current-Operated Protective Device (RCD)/Earth Leakage Circuit Breaker (ELCB) and Magnetic Contactor (MC)

Power supply voltage	Nominal applied motor (HP)	Inverter type	MCCB, RCD/ELCB Rated current (A)	MC	
				For input circuit	For input circuit
Three-phase 230 V	1	FRN001AR1■-2U	5	SC-05	SC-05
	2	FRN002AR1■-2U	10		
	3	FRN003AR1■-2U			
	5	FRN005AR1■-2U	15	SC-4-0	
	7.5	FRN007AR1■-2U	30		
	10	FRN010AR1■-2U		SC-5-1	SC-5-1
	15	FRN015AR1■-2U	50	SC-N1	SC-N1
	20	FRN020AR1■-2U	60	SC-N2	SC-N2
	25	FRN025AR1■-2U	75	SC-N2S	SC-N2S
	30	FRN030AR1■-2U	100		SC-N3
	40	FRN040AR1■-2U	125	SC-N4	SC-N4
	50	FRN050AR1■-2U	150	SC-N5	SC-N5
	60	FRN060AR1■-2U	175	SC-N7	SC-N7
	75	FRN075AR1S-2U	250	SC-N8	SC-N8
	100	FRN100AR1S-2U	300	SC-N11	SC-N11
	125	FRN125AR1S-2U	350		

Note: A box (■) replaces an alphabetic letter depending on the enclosure.
M (NEMA/UL TYPE 1) or L (NEMA/UL TYPE 12)

Table 4.4 Rated Current of Molded Case Circuit Breaker (MCCB), Residual-Current-Operated Protective Device (RCD)/Earth Leakage Circuit Breaker (ELCB) and Magnetic Contactor (MC) (continued)

Power supply voltage	Nominal applied motor (HP)	Inverter type	MCCB, RCD/ELCB Rated current (A)	MC		
				For input circuit	For output circuit	
Three-phase 460 V	1	FRN001AR1■-4U	5	SC-05	SC-05	
	2	FRN002AR1■-4U				
	3	FRN003AR1■-4U				
	5	FRN005AR1■-4U	10			
	7.5	FRN007AR1■-4U	15			SC-05
	10	FRN010AR1■-4U				
	15	FRN015AR1■-4U	30	SC-4-0		
	20	FRN020AR1■-4U		SC-5-1	SC-5-1	
	25	FRN025AR1■-4U	40	SC-N1	SC-N1	
	30	FRN030AR1■-4U	50			
	40	FRN040AR1■-4U	60	SC-N2	SC-N2	
	50	FRN050AR1■-4U	75	SC-N2S	SC-N2S	
	60	FRN060AR1■-4U	100	SC-N3	SC-N3	
	75	FRN075AR1■-4U	125		SC-N4	
	100	FRN100AR1■-4U	150	SC-N4	SC-N5	
	125	FRN125AR1■-4U	175	SC-N7	SC-N7	
	150	FRN150AR1S-4U	250	SC-N8	SC-N8	
	200	FRN200AR1S-4U	250			
	250	FRN250AR1S-4U	300	SC-N11	SC-N11	
	300	FRN300AR1S-4U	400	SC-N12	SC-N12	
	350	FRN350AR1S-4U				
	450	FRN450AR1S-4U	600	SC-N14	SC-N14	
	500	FRN500AR1S-4U				
	600	FRN600AR1S-4U	800	SC-N16	SC-N16	
800	FRN800AR1S-4U	1000	610CM *1	610CM *1		
900	FRN900AR1S-4U	1200	612CM *1	612CM *1		
1000	FRN1000AR1S-4U	1400	616CM *1	616CM *1		

*1 The 610CM, 612CM, and 616CM are manufactured by Aichi Electric Works Co., Ltd.

Note: A box (■) replaces an alphabetic letter depending on the enclosure.
M (NEMA/UL TYPE 1) or L (NEMA/UL TYPE 12)

Table 4.4 Rated Current of Molded Case Circuit Breaker (MCCB), Residual-Current-Operated Protective Device (RCD)/Earth Leakage Circuit Breaker (ELCB) and Magnetic Contactor (MC) (continued)

Power supply voltage	Nominal applied motor (HP)	Inverter type	MCCB, RCD/ELCB Rated current (A)	MC		
				For input circuit	For output circuit	
Three-phase 575 V	1	FRN001AR1■-5U	5	SC-05	SC-05	
	2	FRN002AR1■-5U				
	3	FRN003AR1■-5U				
	5	FRN005AR1■-5U	10			
	7.5	FRN007AR1■-5U				
	10	FRN010AR1■-5U				
	15	FRN015AR1■-5U				
	20	FRN020AR1■-5U	30			SC-4-0
	25	FRN025AR1■-5U				SC-4-0
	30	FRN030AR1■-5U	40			SC-5-1
	40	FRN040AR1■-5U	50	SC-N1		
	50	FRN050AR1■-5U	60	SC-N2	SC-N2	
	60	FRN060AR1■-5U	75	SC-N2	SC-N2S	
	75	FRN075AR1■-5U	100	SC-N2S	SC-N3	
	100	FRN100AR1■-5U	125	SC-N3	SC-N4	
	125	FRN125AR1■-5U	150	SC-N4		
	150	FRN150AR1■-5U	175	SC-N5	SC-N5	
	200	FRN200AR1S-5U	250	SC-N7	SC-N8	
250	FRN250AR1S-5U	300	SC-N8	SC-N11		
300	FRN300AR1S-5U	350	SC-N11			

Note: A box (■) replaces an alphabetic letter depending on the enclosure.
M (NEMA/UL TYPE 1) or L (NEMA/UL TYPE 12)

- Install the MCCB or RCD/ELCB at the input side of the inverter. They cannot be installed at the output side of the inverter.
- The above table lists the rated current of MCCBs and RCDs/ELCBs to be used in the power control panel with an internal temperature of lower than 50°C (122°F). The rated current is factored by a correction coefficient of 0.85 as the MCCBs' and RCDs/ELCBs' original rated current is specified when using them in an ambient temperature of 50°C (122°F) or lower. Select an MCCB and/or RCD/ELCB suitable for the actual short-circuit breaking capacity needed for your power systems.
- For the selection of the MC type, it is assumed that the **600 V HIV wires (allowable ambient temperature: 75°C (167°F))** for the power input/output of the inverter are used. If an MC type for another class of wires is selected, the wire size suitable for the terminal size of both the inverter and the MC type should be taken into account.
- Use RCDs/ELCBs with overcurrent protection.
- To protect your power systems from secondary accidents caused by the broken inverter, use an MCCB and/or RCD/ELCB with the rated current listed in the above table. Do not use an MCCB or RCD/ELCB with a rating higher than that listed.

4.3.2 Surge killers for L-load

A surge killer absorbs surge voltage induced by L-load of an electro magnetic switch or solenoid valve. Use of a surge killer is effective in preventing the electronic equipment, including inverters, from damage or malfunctioning caused by such surges. Surge killers cannot be used with the 575V class series.

Install a surge killer near the power coil of the surge source. Connected to the inverter's power source side, as shown in Figure 4.3, a surge killer absorbs the surge voltage, preventing the electronic equipment from damage or malfunctioning. (The surge killer is available for inverters of 5 HP or less.)

Refer to the catalog "Fuji Surge Killers/Absorbers (HS118: Japanese edition only)" for details. These products are available from Fuji Electric Technica Co., Ltd.

Note: Do not connect the surge killers to the secondary (output) circuit of the inverter.

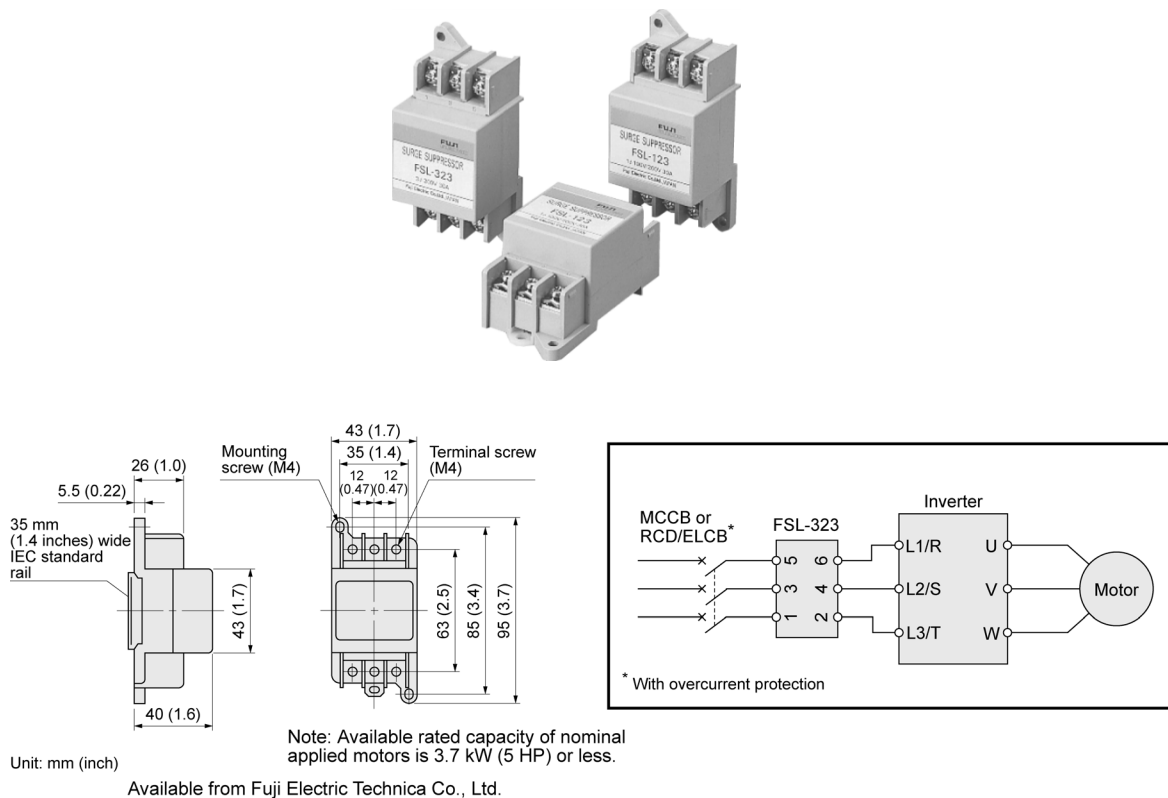

Figure 4.3 Dimensions of Surge Killer and Connection Example

4.3.3 Arresters

An arrester suppresses surge currents induced by lightning invaded from the power supply lines. Common use of the grounding wire for electronic equipment in the panel and the arrester is effective in preventing electronic equipment from damage or malfunctioning caused by such surges. Arresters cannot be used with the 575V class series.

Applicable arrester models are CN5132 for three-phase 230V class series, and CN5134 for three-phase 460V class series. (CN523 series with 20 kA of discharging capability is also available.) Figure 4.4 shows their external dimensions and connection examples. Refer to the catalog "Fuji Surge Killers/Absorbers (HS165a: Japanese edition only)" for details. These products are available from Fuji Electric Technica Co., Ltd.



● Three-phase (230/460 VAC)

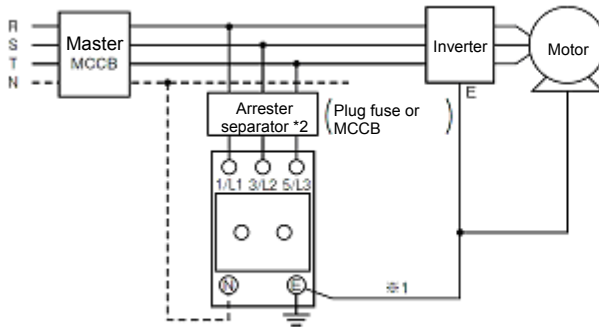

- *1 Keep the wiring length as short as possible.
- *2 The models with a built-in arrester separator (CN5212-FK and CN5232-FK) are not required when the short-circuit current of the circuit is 250 VAC, 10 kA or less.

(N-phase terminal is only for CN5234 and CN5234-K.)

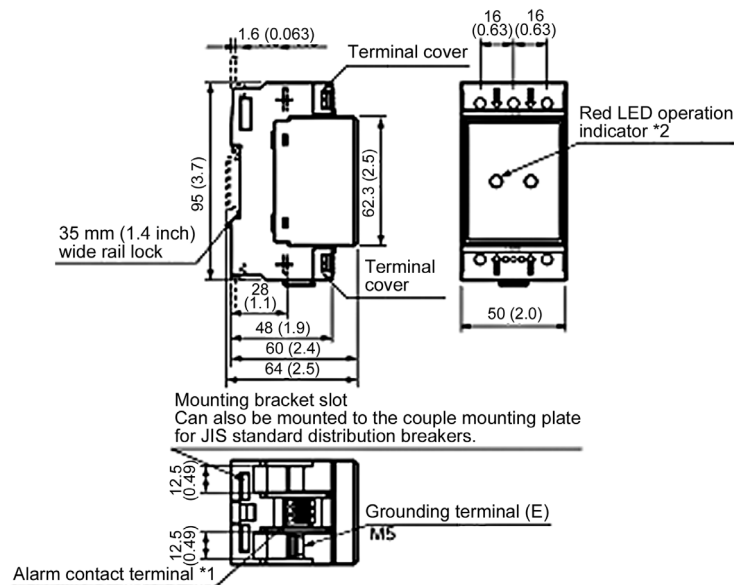

Unit: mm (inch)

- *1 Available only on the CN5□-K series.
- *2 Two-pole models have only the left indicator.

Available from Fuji Electric Technica Co., Ltd.

Figure 4.4 Arrester Dimensions and Connection Examples

4.3.4 Surge absorbers

A surge absorber absorbs surges or noises generated by a magnetic contactor (MC) or solenoid valve in the power system to effectively protect electronic equipment in the panel from malfunctions or breakdown. Installed parallel to a coil of an MC, solenoid valve, or L load, a surge absorber absorbs a surge voltage. Surge absorbers cannot be used with the 575V class series.

Applicable surge absorber models are the S2-A-O and S1-B-O. Figure 4.5 shows their external dimensions.

The surge absorbers are available from Fuji Electric Technica Co., Ltd.

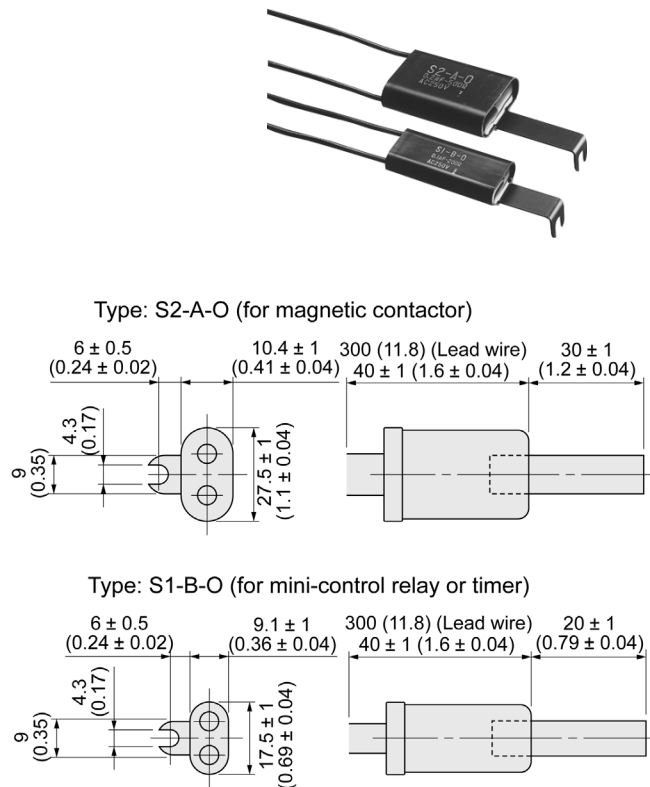

Unit: mm (inch)

Available from Fuji Electric Technica Co., Ltd.

Figure 4.5 Surge Absorber Dimensions

4.4 Options

4.4.1 Selecting peripheral equipment options

4.4.1.1 Power regenerative PWM converters, RHC series

[1] Overview

- Possible to reduce power supply facility capacity

Its power-factor control realizes the same phase current as the power-supply phase-voltage. The equipment, thus, can be operated with the power-factor of almost "1."

This makes it possible to reduce the power transformer capacity and downsize the other devices, compared with those required without the converter.

- Upgraded braking performance

Regenerated energy occurring at highly frequent accelerating and decelerating operation and elevating machine operation is entirely returned to power supply side.

Thus, energy saving during regenerative operation is possible.

As the current waveform is sinusoidal during regenerative operation, no troubles are caused to the power supply system.

Rated continuous regeneration: 100%
 Rated regeneration for 1 min 150% (CT use)
 120% (VT use)

- Enhanced maintenance/protective functions

Failure can be easily analyzed with the trace back function (option).

- 1) The past 10 alarms can be displayed with the 7-segment LEDs.
This helps you analyze the alarm causes and take countermeasures.
- 2) When momentary power failure occurs, the converter shuts out the gate to enable continuous operation after recovery.
- 3) The converter can issue warning signals like overload, heat sink overheating, or the end of service life prior to converter tripping.

- Enhanced network support

The converter can be connected to MICREX-SX, F series and CC-Link master devices (using option).

The RS-485 interface is provided as standard.

- Making the inverter incompliant with the EMC standards

The inverter combined with the PWM converter is no longer compliant with the EMC standards.



Comparison of Input Current Waveforms
 (With PWM converter) (Without PWM converter)

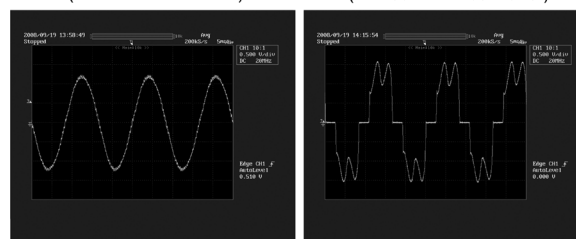

Allowable characteristics of the RHC unit

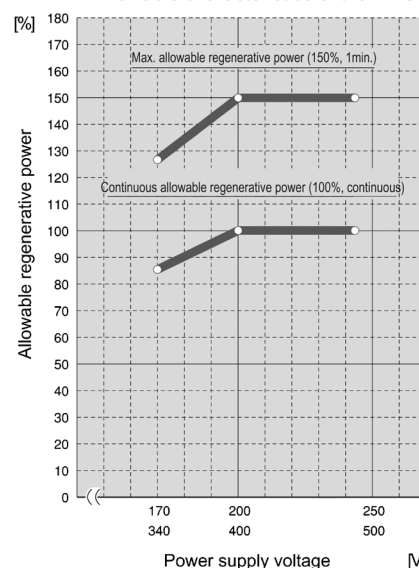

⚠ WARNING

When using 230 V class series inverters of 60 HP or below and 460 V ones of 125 HP or below in combination with the PWM converter, be sure to remove EMC filter grounding screws (E1, E2). The 230 V class series inverters of 75HP or above and 460 V ones of 150 HP or above, remove the connector of the EMC filter.

Fire or an accident could occur.

When replacing conventional models (FRENIC5000VG7S, FRENIC5000G11S) with the FRENIC-HVAC, it may be necessary to change wiring.

Malfunction could occur.

[2] Specifications

[2.1] Standard specifications

■ 230 V class series

Item		Standard specifications											
Type RHC□□□-2C		230 V class series											
		7.5	11	15	18.5	22	30	37	45	55	75	90	
CT mode	Applicable inverter capacity (HP)	10	15	20	25	30	40	50	60	75	100	125	
	Applicable inverter capacity (kW)	7.5	11	15	18.5	22	30	37	45	55	75	90	
	Output	Continuous capacity (kW)	8.8	13	18	22	26	36	44	53	65	88	103
		Overload rating	150% of continuous rating for 1 min										
		Voltage 200 V	320 to 355 V (Variable with input power voltage) (*1)										
	Required power supply (kVA)	9.5	14	19	24	29	38	47	57	70	93	111	
Carrier frequency	15 kHz (typical)										10 kHz (typical)		
VT mode	Applicable inverter capacity (HP)	15	20	25	30	40	50	60	75	100	125	150	
	Applicable inverter capacity (kW)	11	15	18.5	22	30	37	45	55	75	90	110	
	Output	Continuous capacity (kW)	13	18	22	26	36	44	53	65	88	103	126
		Overload rating	120% of continuous rating for 1 min										
		Voltage 200 V	320 to 355 V (Variable with input power voltage) (*1)										
	Required power supply (kVA)	14	19	24	29	38	47	57	70	93	111	136	
Carrier frequency	10 kHz (typical)										6 kHz (typical)		
Input power	Number of phases, voltage, frequency	Three-phase three lines, 200 to 220 V 50 Hz, 200 to 230 V 60 Hz (*2)											
	Voltage/frequency fluctuation	Voltage: -15 to +10%, Frequency: ±5%, Voltage unbalance: 2% or less (*3)											

(*1) When the power supply voltage is 200 V, 220 V or 230 V, the output voltage is approximate 320 VDC, 343 VDC, or 355 VDC, respectively.

(*2) The input power 220-230 V / 50 Hz is available by individual order.

(*3) Voltage unbalance (%) = (Max. voltage (V) - Min. voltage (V)) / Three-phase average voltage (V) x 67

■ 460 V class series

Item		Standard specifications																							
Type RHC□□□-4C		460 V class series																							
		7.5	11	15	18.5	22	30	37	45	55	75	90	110	132	160	200	220	280	315	355	400	500	630		
CT mode	Applicable inverter capacity (HP)	10	15	20	25	30	40	50	60	75	100	125	150	200	250	300	350	450	475	500	600	800	900		
	Applicable inverter capacity (kW)	7.5	11	15	18.5	22	30	37	45	55	75	90	110	132	160	200	220	280	315	355	400	500	630		
	Output	Continuous capacity (kW)	8.8	13	18	22	26	36	44	53	65	88	103	126	150	182	227	247	314	353	400	448	560	705	
		Overload rating	150% of continuous rating for 1 min																						
		Voltage 400 V	640 to 710 V (Variable with input power voltage) (*1)																						
	Required power supply (kVA)	9.5	14	19	24	29	38	47	57	70	93	111	136	161	196	244	267	341	383	433	488	610	762		
Carrier frequency	15 kHz (typical)										10 kHz (typical)										6 kHz (typical)				
VT mode	Applicable inverter capacity (HP)	15	20	25	30	40	50	60	75	100	125	150	200	250	300	350	450	475	500	600	800	-	-		
	Applicable inverter capacity (kW)	11	15	18.5	22	30	37	45	55	75	90	110	132	160	200	220	280	315	355	400	500	-	-		
	Output	Continuous capacity (kW)	13	18	22	26	36	44	53	65	88	103	126	150	182	227	247	314	353	400	448	560	-	-	
		Overload rating	120% of continuous rating for 1 min																						
		Voltage 400 V	640 to 710 V (Variable with input power voltage) (*1)																						
	Required power supply (kVA)	14	19	24	29	38	47	57	70	93	111	136	161	196	244	267	341	383	433	488	610	-	-		
Carrier frequency	10 kHz (typical)										6 kHz (typical)														
Input power	Number of phases, voltage, frequency	Three-phase three lines, 380 to 440 V 50 Hz, 380 to 460 V 60 Hz (*2)																							
	Voltage/frequency fluctuation	Voltage: -15 to +10%, Frequency: ±5%, Voltage unbalance: 2% or less (*3)																							

(*1) When the power supply voltage is 400 V, 440 V, or 460 V, the output voltage is approximate 640 VDC, 686 VDC, or 710 VDC, respectively.

(*2) When the power supply voltage is 380 to 398 V/50 Hz and 380 to 430 V/60 Hz, tap-switching is required in the converter. When the power supply voltage is less than 400 V, it is necessary to decrease the converter capacity.

(*3) Voltage unbalance (%) = (Max. voltage (V) - Min. voltage (V)) / Three-phase average voltage (V) x 67

[2.2] Common specifications

Item		Specifications
Control	Control method	AVR constant control with DC ACR minor
	Running/Stopping	Starts rectification when the converter is powered ON after connection. Starts boosting when it receives a run signal (terminals [RUN] and [CM] short-circuited or a run command via the communications link). After that, the converter is ready to run.
	Running status signal	Running, power running, regenerative operation, ready-to-run, alarm output (for any alarm), etc.
	CT/VT switching	Switching between CT and VT modes. CT: 150% of overload rating for 1 min VT: 120% of overload rating for 1 min (Converters of 500 kW or above are fixed in CT mode.)
	Carrier frequency	Fixed to high carrier frequency
	Input power factor	0.99 or above (under 100% load) (*1)
	Restart after momentary power failure	Shields the gate when the voltage level reaches the undervoltage level if a momentary power failure occurs, and the converter can automatically restart after the power recovers.
	Power limiting control	Controls the power not to exceed the preset limit value.

(*1) When the power supply voltage is 420 V or above and the converter is running under 50% load or above, the power factor decreases to about 0.95 (only under regenerative control).

Item		Specifications
Indication	Alarm display (Protective functions)	AC fuse blown, AC overvoltage, AC undervoltage, AC overcurrent, AC input current error, input phase loss, synchronous power supply frequency error, DC fuse blown, DC overvoltage, DC undervoltage, charge circuit fault, heat sink overheat, external alarm, converter internal overheat, overload, memory error, keypad communications error, CPU error, network device error, operation procedure error, A/D converter error, optical network error, IPM error
	Alarm history	Saves and displays the most recent 10 alarms. Saves and displays the detailed information of the trip cause for the previous alarm.
	Monitor	Displays input power, input current in RMS, input voltage in RMS, DC link bus voltage and power supply frequency.
	Load factor	Allows the user to measure the load factor with the keypad.
	Language	Allows the user to specify or refer to function codes in any of the three languages--Japanese, English and Chinese.
	Charging lamp	Lights when the DC link bus capacitor is charged.

[3] Function specifications

(1) Terminal functions

Classification	Symbol	Name	Functions
Main circuit	L1/R, L2/S, L3/T	Main circuit power inputs	Connects with the three-phase input power lines through a dedicated reactor.
	P(+), N(-)	Converter outputs	Connects with the power input terminals P(+) and N(-) on an inverter.
	 G	Grounding	Grounding terminal for the converter's chassis (or casing).
	R0, T0	Auxiliary power input for the control circuit	For a backup of the control circuit power supply, connect the power lines same as that of the main power input.
Voltage detection	R1, S1, T1	Synchronous power input for voltage detection	Voltage detection terminals for the internal control of the converter. Connect with the power supply side of the dedicated reactor or filter.
	R2, T2	Inputs for control monitoring	Detection terminal for AC fuse blown.
Input signal	[RUN]	Run command	Short-circuiting terminals [RUN] and [CM] runs the converter; opening them stops the converter.
	[RST]	Reset alarm command	When the converter stops due to an alarm, removing the alarm factor and short-circuiting the terminals [RST] and [CM] cancels the protective function, restarting the converter.
	[X1]	General-purpose transistor input	0: Enable external alarm trip THR 1: Cancel current limiter LMT-CCL 2: 73 answerback 73ANS 3: Switch current limiter I-LIM 4: Option DI OPT-DI
	[CM]	Digital input common	Common terminal for digital input signals.
	[PLC]	PLC signal power	Connects to PLC output signal power supply. (Rated voltage: 24 VDC (22 to 27 VDC))

Classification	Symbol	Name	Functions
Output signal	[30A/B/C]	Alarm relay output (for any alarm)	Outputs a signal when the protective function is activated to stop the converter. (Contact: [1C], Terminals [30A] and [30C] are closed: Signal ON) (Contact rating: 250 VAC, max. 50 mA)
	[Y1], [Y2], [Y3], [Y11] to [Y18]	General-purpose transistor output	0: Converter running RUN 1: Converter ready to run RDY 2: Power supply current limiting IL 3: Lifetime alarm LIFE 4: Heat sink overheat early warning PRE-OH 5: Overload early warning PRE-OL 6: Power running DRV 7: Regenerating REG 8: Current limiting early warning CUR 9: Restarting after momentary power failure U-RES 10: Synchronizing power supply frequency SY-HZ 11: Alarm content 1 AL1 12: Alarm content 2 AL2 13: Alarm content 4 AL4 14: Option DO OPT-DO * Mounting the OPC-VG7-DIOA option makes 8 points of DO extended functions available. (DI functions are not available.)
	[CME]	Digital output common	
	[Y5A/C]	Relay output	
	[A01], [A04], [A05]	General-purpose analog output	0: Input power PWR 1: Input current in RMS I-AC 2: Input voltage in RMS V-AC 3: DC link bus voltage V-DC 4: Power supply frequency FREQ 5: +10 V test P10 6: -10 V test N10 * Mounting the OPC-VG7-AIO option makes 2 points of AO extended functions available. (AI functions are not available.)
	[M]	Analog output common	Common terminal for analog output signal.
	[73A], [73C]	Charging resistor input relay outputs	Control output for the input relay of the external charging resistor (73).

(2) Communications specifications

Item	Specifications	
General communications specifications	Monitoring the running information, running status and function code data, and controlling (selecting) the terminals [RUN], [RST] and [X1]. * Writing to function codes is not possible.	
RS-485 (built-in, as standard)	Communicating with a PC or PLC. (The converter supports the Fuji general-purpose inverter protocol and Modbus RTU protocol.)	
T-Link (option)	Mounting the OPC-VG7-TL option enables communication with a T-Link module of MICREX-F or MICREX-SX via a T-Link network.	
SX-bus (option)	Mounting the OPC-VG7-SX option enables communication with a MICREX-SX via an SX bus network.	
CC-Link (option)	Mounting the OPC-VG7-CCL option enables communication with a CC-Link master.	
Traceback (option)	Hardware	Mounting the OPC-RHC-TR option enables tracing back of the running status data of the converter. WPS-LD-TR software is required.
	Software	Installing the WPS-RHC-TR software enables collecting of traceback data on the PC.
Optical communication (option)	Mounting the OPC-VG7-SI option enables load sharing control in the parallel multiplex system, supporting up to 2400 kW capacity.	

(3) Function settings

Function code	Name	Function code	Name
F00	Data protection	H01	Station address
F01	High frequency filter selection	H02	Communications error processing
F02	Restart mode after momentary power failure (Mode selection)	H03	Timer
		H04	Baud rate
F03	Current rating switching	H05	Data length
F04	LED monitor, item selection	H06	Parity bits
F05	LCD monitor, item selection	H07	Stop bits
F06	LCD monitor, language selection	H08	No-response error detection time
F07	LCD monitor, contrast control	H09	Response interval
F08	Carrier frequency	H10	Protocol selection
E01	Terminal [X1] function	H11	TL transmission format
E02 to E13	Terminal [Y1], [Y2], [Y3,], [Y5], [Y11] to [Y18] function	H12	Parallel system
		H13	Number of slave stations in parallel system
E14	I/O function normal open/closed	H14	Clear alarm data
E15	RHC overload early warning level	H15, H16	Power supply current limiter (driving 1/2)
E16	Cooling fan ON/OFF control	H17, H18	Power supply current limiter (braking 1/2)
E17	Under current limiting (Hysteresis width)	H19, H20	Current limiting early warning (level/timer)
E18 to E20	A01, A04 and A05, function selection	M09	Power supply frequency
E21 to E23	A01, A04 and A05, gain setting	M10	Input power
E24 to E26	A01, A04 and A05, bias setting	M11	Input current in RMS
E27	A01, A04 and A05, filter setting	M12	Input voltage in RMS
S01	Operation method	M13	Run command
S02, S03	Power supply current limiting (driving/braking)	M14	Running status
		M15	Output terminals [Y1] to [Y18]

(4) Protective functions

Item	LED monitor displays:	Description	Remarks
AC fuse blown	ACF	Stops the converter output if the AC fuse (R-/T-phase only) is blown.	
AC overvoltage	AOV	Stops the converter output upon detection of an AC overvoltage condition.	
AC undervoltage	ALV	Stops the converter output upon detection of an AC undervoltage condition.	
AC overcurrent	AOC	Stops the converter output if the peak value of the input current exceeds the overcurrent level.	
AC input current error	ACE	Stops the converter output upon detection of the excessive deviation of the AC reactor from the AC input.	
Input phase loss	LPV	Stops the converter output upon detection of an input phase loss.	
Synchronous power frequency error	FrE	After the MC for charging circuit (73) is turned on, the converter checks the power frequency. If it detects a power frequency error, this function stops the converter output. An error during converter running (e.g., momentary power failure) triggers no alarm.	
DC fuse blown	dCF	Stops the converter output if the DC fuse (P side) is blown.	18.5 kW(25HP) or above
DC overvoltage	dOV	Stops the converter output upon detection of a DC overvoltage condition. If a power failure continues for a long time and the control power source is shut down, this alarm is automatically reset.	230 V class series: 400 V \pm 3 V 460 V class series: 800 V \pm 5 V
DC undervoltage	dLV	Stops the converter output upon detection of a DC undervoltage condition. If a power failure continues for a long time and the control power source is shut down, this alarm is automatically reset.	230 V class series: Stops at 185 V, restarts at 208 V. 460 V class series: Stops at 371 V, restarts at 417 V.
Charging circuit fault	PbF	Stops the converter output upon detection of a charging circuit fault, provided that the answerback signal from 73 is enabled.	Condition: 73ANS (Answerback from 73) is assigned to terminal [X1].
Heat sink overheat	OH1	Stops the converter output upon detection of a heat sink overheat.	
External alarm	OH2	Stops the converter output upon receipt of an external signal THR .	Condition: THR (Enable external alarm trip) is assigned to terminal [X1].
Converter internal overheat	OH3	Stops the converter output upon detection of an internal overheat of the converter.	
Converter overload	OLU	Stops the converter output with the inverse-time characteristics due to the input current.	Activate at 105%, 150% for 1 min

Item	LED monitor displays:	Description	Remarks
Memory error	Er1	Stops the converter output if a data writing error or any other memory error occurs (when the checksums of the EEPROM and RAM do not match).	
Keypad communications error	Er2	Displays "Er2" upon detection of a wire break in initial communication with the keypad. This does not affect the converter operation.	
CPU error	Er3	Activated if a CPU error occurs.	
Network device error	Er4	Stops the converter output if a fatal error (including no power supply connection) occurs in the master unit in the network.	Applies to T-Link, SX-bus, and CC-Link devices.
Operation procedure error	Er6	Stops the converter output upon detection of an error in the operation procedure.	
A/D converter error	Er8	Stops the converter output upon detection of a failure in the A/D converter circuit.	
Optical network error	Erb	Stops the converter output upon detection of an optical cable break or a fatal error in the optical option.	
IPM error	IPE	Activated when the IPM's self-diagnosis function works due to an overcurrent or overheat.	15 kW (20HP) or below

(5) Required structure and environment

Item	Required structure, environment and standards	Remarks
Structure	Structure	Mounting in a panel or mounting for external cooling
	Enclosure	Open type
	Cooling system	Forced air cooling
	Installation	Vertical installation
	Coating color	Munsell 5Y3/0.5, eggshell
	Maintainability	Structure designed for easy parts replacement
Environment	Site location	Shall be free from corrosive gases, flammable gases, dusts, and direct sunlight. Indoor use only.
	Ambient temperature	-10 to 50°C (14 to 122°F)
	Relative humidity	5 to 95% RH (No condensation)
	Altitude	3000 m (9800 ft) max. (For use in an altitude between 1001 m to 3000 m (3300 ft to 9800 ft), the output current should be derated.)
	Vibration	2 to 9 Hz: Amplitude = 3 mm, 9 to 20 Hz: 9.8 m/s ² , 20 to 55 Hz: 2 m/s ² (9 to 55 Hz: 2 m/s ² for 90 kW or above), 55 to 200 Hz: 1 m/s ²
	Storage temperature	-20 to 55°C (-4 to 131°F)
Storage humidity	5 to 95% RH	

[4] Converter configuration

CT mode

Power supply Nominal applied motor (kW)	PWM converter type	MC for charging circuit		MC for power supply		Charging circuit box (*1)						Boosting reactor		Filtering resistor		Filtering reactor		Filtering capacitor		MC for filtering circuit	
		(73)	Q/ty	(52)	Q/ty	Charging resistor			Fuse			(Lr)	Q/ty	(Lf)	Q/ty	(Lf)	Q/ty	(Cf)	Q/ty	(6F)	Q/ty
						(CU)	(R0)	(F)													
200 V class series	7.5	RHC7.5-2C	SC-5-1	1		CU7.5-2C	1	(80W 7.5Ω)	(3)	(CR2LS-50/UL)	(2)	LR2-7.5C	1	GRZG80 0.42Ω	3	LFC2-7.5C	1	CF2-7.5C	1		
	11	RHC11-2C	SC-N1	1		CU11-2C	1	(HF5C5504)		(CR2LS-75/UL)	(2)	LR2-15C	1	GRZG150 0.2Ω	3	LFC2-15C	1	CF2-15C	1		
	15	RHC15-2C	SC-N2	1		CU15-2C	1			(CR2LS-100/UL)	(2)										
	18.5	RHC18.5-2C	SC-N3	1		CU18.5-2C	1	(GRZG120 2Ω)	(3)			LR2-22C	1	GRZG200 0.13Ω	3	LFC2-22C	1	CF2-22C	1		
	22	RHC22-2C				CU22-2C	1			(CR2LS-150/UL)	(2)										
	30	RHC30-2C	SC-N4	1		CU30-2C	1			(CR2LS-200/UL)	(2)	LR2-37C	1	GRZG400 0.1Ω	3	LFC2-37C	1	CF2-37C	1		
	37	RHC37-2C	SC-N5	1		CU45-2C	1			(CR2LS-260/UL)	(2)										
	45	RHC45-2C	SC-N7	1								LR2-55C	1				LFC2-55C	1	CF2-55C	1	
	55	RHC55-2C	SC-N8	1		CU55-2C	1			(CR2LS-400/UL)	(2)										
	75	RHC75-2C	SC-N11	1		CU75-2C	1					LR2-75C	1				LFC2-75C	1	CF2-75C	1	
90	RHC90-2C				CU90-2C	1	(GRZG400 1Ω)	(3)	(A50P600-4)	(2)	LR2-110C	1	GRZG400 0.12Ω	6	LFC2-110C	1	CF2-110C	1			
400 V class series	7.5	RHC7.5-4C	SC-05	1		CU7.5-4C	1	(TK50B 30Ω)	(3)	(CR6L-30/UL)	(2)	LR4-7.5C	1	GRZG80 1.74Ω	3	LFC4-7.5C	1	CF4-7.5C	1		
	11	RHC11-4C	SC-4-0	1		CU15-4C	1	(HF5B0416)		(CR6L-50/UL)	(2)	LR4-15C	1	GRZG150 0.79Ω	3	LFC4-15C	1	CF4-15C	1		
	15	RHC15-4C	SC-5-1	1																	
	18.5	RHC18.5-4C	SC-N1	1		CU18.5-4C	1	(80W 7.5Ω)	(3)			LR4-22C	1	GRZG200 0.53Ω	3	LFC4-22C	1	CF4-22C	1		
	22	RHC22-4C				CU22-4C	1	(HF5C5504)		(CR6L-75/UL)	(2)										
	30	RHC30-4C	SC-N2	1		CU30-4C	1			(CR6L-100/UL)	(2)	LR4-37C	1	GRZG400 0.38Ω	3	LFC4-37C	1	CF4-37C	1		
	37	RHC37-4C	SC-N2S	1		CU45-4C	1			(CR6L-150/UL)	(2)										
	45	RHC45-4C	SC-N3	1								LR4-55C	1	GRZG400 0.26Ω	3	LFC4-55C	1	CF4-55C	1		
	55	RHC55-4C	SC-N4	1		CU55-4C	1			(CR6L-200/UL)	(2)										
	75	RHC75-4C	SC-N5	1		CU75-4C	1					LR4-75C	1	GRZG400 0.38Ω	3	LFC4-75C	1	CF4-75C	1		
	90	RHC90-4C	SC-N7	1		CU90-4C	1			(CR6L-300/UL)	(2)	LR4-110C	1	GRZG400 0.53Ω	6	LFC4-110C	1	CF4-110C	1		
	110	RHC110-4C	SC-N8	1		CU110-4C	1	(GRZG120 2Ω)	(3)												
	132	RHC132-4C				CU132-4C	1			(A50P400-4)	(2)	LR4-160C	1	RF4-160C	1	LFC4-160C	1	CF4-160C	1		
	160	RHC160-4C	SC-N11	1		CU160-4C	1			(A50P600-4)	(2)										
	200	RHC200-4C	SC-N12	1		CU200-4C	1	(GRZG400 1Ω)	(3)			LR4-220C	1	RF4-220C	1	LFC4-220C	1	CF4-220C	1		
	220	RHC220-4C				CU220-4C	1			(A70QS800-4)	(2)										
	280	RHC280-4C	SC-N3	1	SC-N14	1		GRZG400 1Ω	6	A70QS800-4	2	LR4-280C	1	RF4-280C	1	LFC4-280C	1	CF4-280C	1	SC-N4	1
315	RHC315-4C						(2 pcs in parallel)		A70P1600-4TA	2	LR4-315C	1	RF4-315C	1	LFC4-315C	1	CF4-315C	1			
355	RHC355-4C										LR4-355C	1	RF4-355C	1	LFC4-355C	1	CF4-355C	1			
400	RHC400-4C			SC-N16	1						LR4-400C	1	RF4-400C	1	LFC4-400C	1	CF4-400C	1			
500	RHC500-4C			SC-N11	3						LR4-500C	1	RF4-500C	1	LFC4-500C	1	CF4-500C	1	SC-N4(*3)	1	
630	RHC630-4C			SC-N12	3				A70P2000-4T	2	LR4-630C	1	RF4-630C	1	LFC4-630C	1	CF4-630C	1	SC-N7(*4)	1	

(*1) The charging box (CU) contains a combination of a charging resistor (R0) and a fuse (F). If no CU is used, it is necessary to prepare the charging resistor (R0) and fuse (F) at your end.

(*2) The filtering capacitor consists of two pieces of capacitors. For an order of quantity "1," two pieces of capacitors are to be delivered.

(*3) (*4) Lowering the carrier frequency or using the OPC-VG7-SIR increases the generation loss, so use the SC-N4/SF for (*3) and the SC-N8 for (*4).

VT mode

	Power supply Nominal applied motor (kW)	PWM converte r type	MC for charging circuit		MC for power supply		Charging circuit box (*1)						Boosting reactor		Filtering resistor		Filtering reactor		Filtering capacitor		MC for filtering circuit	
			(73)	Qty	(52)	Qty	(CU)	Qty	Charging resistor		Fuse		(Lr)	Qty	(Lf)	Qty	(Lf)	Qty	(Cf)	Qty	(6F)	Qty
									(R0)	Qty	(F)	Qty										
200 V class series	11	RHC7.5-2C	SC-N1	1			CU7.5-2C	1	80W 7.5Ω	(3)	(CR2L-50/UL)	(2)	LR2-15C	1	GRZG150 0.2Ω	3	LFC2-15C	1	CF2-15C	1		
	15	RHC11-2C	SC-N2	1			CU11-2C	1	HF5C5504)	(3)	(CR2L-75/UL)	(2)										
	18.5	RHC15-2C	SC-N3	1			CU15-2C	1		(3)	(CR2L-100/UL)	(2)	LR2-22C	1	GRZG200 0.13Ω	3	LFC2-22C	1	CF2-22C	1		
	22	RHC18.5-2C					CU18.5-2C	1	GRZG120 2Ω)	(3)												
	30	RHC22-2C	SC-N4	1			CU22-2C	1		(3)	(CR2L-150/UL)	(2)	LR2-37C	1	GRZG400 0.1Ω	3	LFC2-37C	1	CF2-37C	1		
	37	RHC30-2C	SC-N5	1			CU30-2C	1		(3)	(CR2L-200/UL)	(2)										
	45	RHC37-2C	SC-N7	1			CU45-2C	1		(3)	(CR2L-260/UL)	(2)	LR2-55C	1				LFC2-55C	1	CF2-55C	1	
	55	RHC45-2C	SC-N8	1						(3)	(CR2L-400/UL)	(2)	LR2-75C	1				LFC2-75C	1	CF2-75C	1	
	75	RHC55-2C	SC-N11	1			CU55-2C	1		(3)												
	90	RHC75-2C					CU75-2C	1		(3)			LR2-110C	1	GRZG400 0.12Ω	6	LFC2-110C	1	CF2-110C	1		
110	RHC90-2C	SC-N12	1			CU90-2C	1	GRZG400 1Ω)	(3)	(A50P600-4)	(2)			GRZG400 0.12Ω	6	LFC2-110C	1	CF2-110C	1			
400 V class series	11	RHC7.5-4C	SC-4-0	1			CU7.5-4C	1	(TK50B 300J)	(3)	(CR6L-30/UL)	(2)	LR4-15C	1	GRZG150 0.79Ω	3	LFC4-15C	1	CF4-15C	1		
	15	RHC11-4C	SC-5-1	1			CU15-4C	1	HF5B0416)	(3)	(CR6L-50/UL)	(2)										
	18.5	RHC15-4C	SC-N1	1						(3)			LR4-22C	1	GRZG200 0.53Ω	3	LFC4-22C	1	CF4-22C	1		
	22	RHC18.5-4C					CU18.5-4C	1	80W 7.5Ω)	(3)	(CR6L-75/UL)	(2)	LR4-37C	1	GRZG400 0.38Ω	3	LFC4-37C	1	CF4-37C	1		
	30	RHC22-4C	SC-N2	1			CU22-4C	1	HF5C5504)	(3)	(CR6L-100/UL)	(2)										
	37	RHC30-4C	SC-N2S	1			CU30-4C	1		(3)	(CR6L-150/UL)	(2)	LR4-55C	1	GRZG400 0.26Ω	3	LFC4-55C	1	CF4-55C	1		
	45	RHC37-4C	SC-N3	1			CU45-4C	1		(3)												
	55	RHC45-4C	SC-N4	1						(3)	(CR6L-200/UL)	(2)	LR4-75C	1	GRZG400 0.38Ω	3	LFC4-75C	1	CF4-75C	1		
	75	RHC55-4C	SC-N5	1			CU55-4C	1		(3)			LR4-110C	1	GRZG400 0.53Ω	6	LFC4-110C	1	CF4-110C	1		
	90	RHC75-4C	SC-N7	1			CU75-4C	1		(3)	(CR6L-300/UL)	(2)			GRZG400 0.53Ω	6	LFC4-110C	1	CF4-110C	1		
	110	RHC90-4C	SC-N8	1			CU90-4C	1		(3)			LR4-160C	1	RF4-160C	1	LFC4-160C	1	CF4-160C	1		
	132	RHC110-4C					CU110-4C	1	GRZG120 2Ω)	(3)												
	160	RHC132-4C	SC-N11	1			CU132-4C	1		(3)	(A50P400-4)	(2)										
	200	RHC160-4C	SC-N12	1			CU160-4C	1		(3)	(A50P600-4)	(2)	LR4-220C	1	RF4-220C	1	LFC4-220C	1	CF4-220C	1		
	220	RHC200-4C					CU200-4C	1	GRZG400 1Ω)	(3)												
	280	RHC220-4C	SC-N14	1			CU220-4C	1		(3)	(A70QS800-4)	(2)	LR4-280C	1	RF4-280C	1	LFC4-280C	1	CF4-280C	1		
	315	RHC280-4C	SC-N3	1	SC-N14	1			GRZG400 1Ω	6	A70QS800-4	2	LR4-315C	1	RF4-315C	1	LFC4-315C	1	CF4-315C	1	SC-N4	1
355	RHC315-4C			SC-N16	1			(2 pcs in parallel)		A70P1600-4TA	2	LR4-355C	1	RF4-355C	1	LFC4-355C	1	CF4-355C	1			
400	RHC355-4C			SC-N16	1							LR4-400C	1	RF4-400C	1	LFC4-400C	1	CF4-400C	1			
500	RHC400-4C			SC-N11	3							LR4-500C	1	RF4-500C	1	LFC4-500C	1	CF4-500C	1	SC-N4/SF	1	

(*1) The charging box (CU) contains a combination of a charging resistor (R0) and a fuse (F). If no CU is used, it is necessary to prepare the charging resistor (R0) and fuse (F) at your end.

(*2) The filtering capacitor consists of two pieces of capacitors. For an order of quantity "1," two pieces of capacitors are to be delivered.

■ RHC280-4C to RHC630-4C (Applicable inverters: FRN450AR1S-4U to FRN900AR1S-4U)

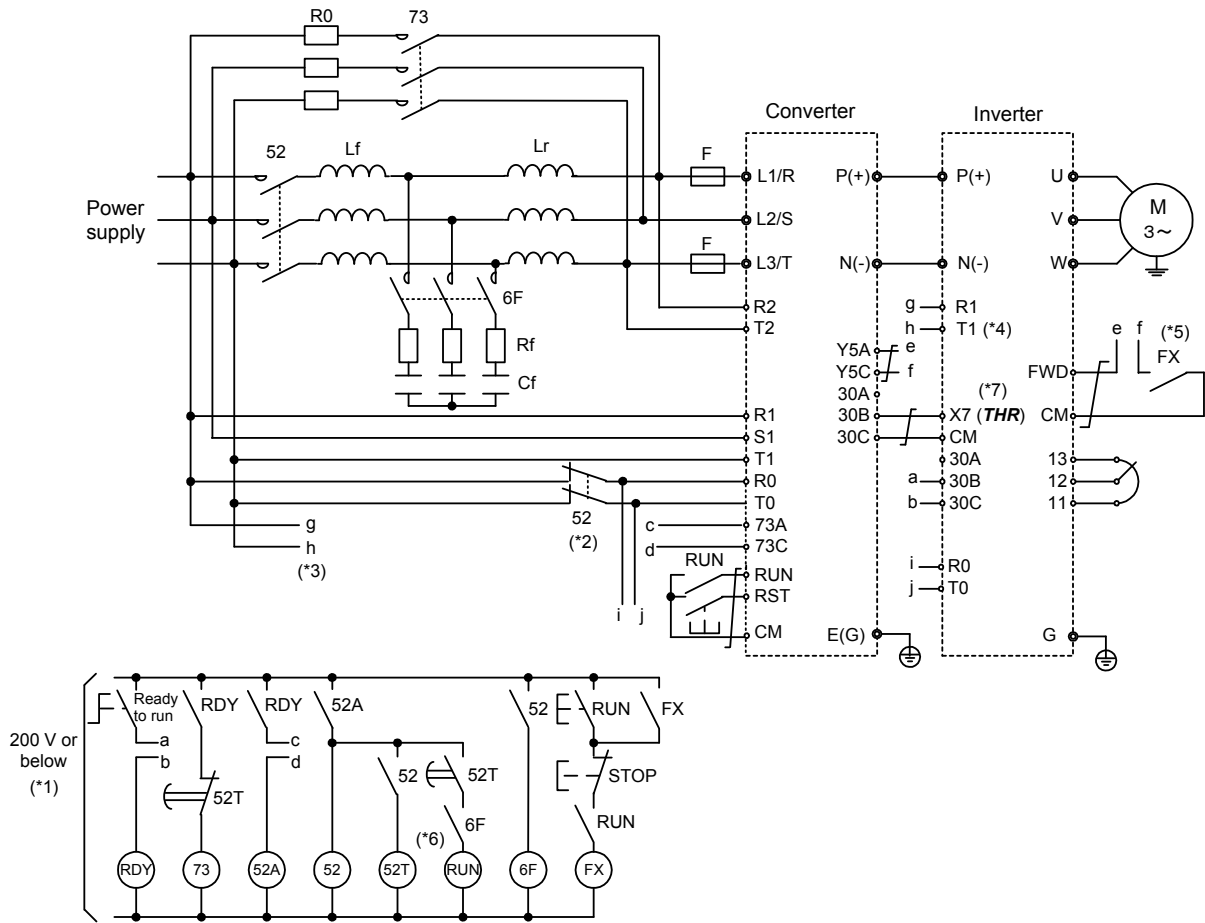

Symbol	Part name
Lr	Boosting reactor
Lf	Filtering reactor
Cf	Filtering capacitor
Rf	Filtering resistor
R0	Charging resistor
F	AC fuse
73	Magnetic contactor for charging circuit
52	Magnetic contactor for power supply
6F	Magnetic contactor for filtering circuit

- (*1) Connect a stepdown transformer to limit the voltage of the sequence circuit to 220 V or below.
- (*2) Be sure to connect the auxiliary power input terminals R0 and T0 of the PWM converter and the inverter to the main power input lines via B contacts of magnetic contactors of the power supply circuit (52). When the PWM converter is to be connected to an ungrounded power supply, an insulation transformer is required. For details, refer to the PWM Converter Instruction Manual (INR-HF51746□).
- (*3) Connect the auxiliary fan power input terminals R1 and T1 of the inverter to the main power input lines without going through the MC's B contacts or 73.
- (*4) Set fan power supply switching connectors CN R and CN W on the **NC** and **FAN** (**73X**) positions, respectively.
- (*5) Construct a sequence in which a run command is given to the inverter after the PWM converter becomes ready to run.
- (*6) Set the timer 52T at 1 sec.
- (*7) Assign the external alarm **THR** to any of terminals [X1] to [X7] on the inverter.
- (*8) Wiring for terminals L1/R, L2/S, L3/T, R2, T2, R1, S1, and T1 should match with the phase sequence.

[6] External dimensions

■ PWM converter

Figure A

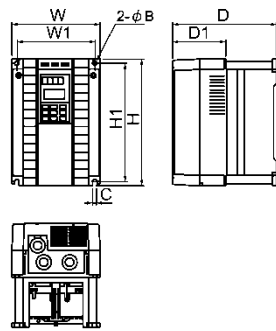

Figure B

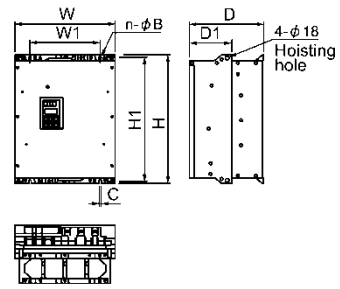

Figure C

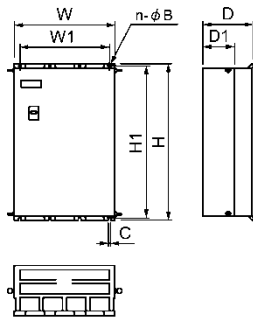
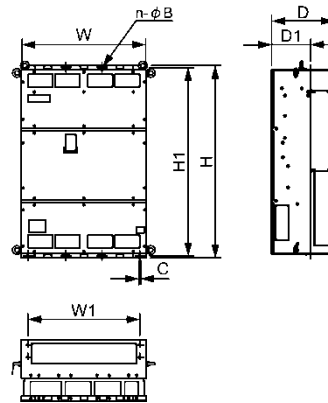

Figure D



PWM converter type		Figure	Dimensions mm(inch)									Approx. mass kg(lbs)						
			W	W1	H	H1	D	D1	N	B	C							
230 V class series	RHC7.5-2C	A	250 (9.84)	226 (8.90)	380	358	245 (9.65)	125 (4.92)	2 (0.08)	10 (0.39)	10 (0.39)	12.5 (28)						
	RHC11-2C				(14.96)	(14.09)												
	RHC15-2C				(14.96)	(14.09)												
	RHC18.5-2C	B	340 (13.39)	240 (9.45)	480	460	255 (10.04)	145 (5.71)	2 (0.08)	10 (0.39)	10 (0.39)	24						
	RHC22-2C				(18.90)	(18.11)						(53)						
	RHC30-2C				(21.65)	(20.87)						(64)						
	RHC37-2C				615	595	270 (10.63)					145 (5.71)	2 (0.08)	10 (0.39)	10 (0.39)	36		
	RHC45-2C				(24.12)	(23.43)										(79)		
	RHC55-2C				375	275	740					720	270 (10.63)	145 (5.71)	2 (0.08)	10 (0.39)	10 (0.39)	42
	RHC75-2C				(14.76)	(10.83)	(29.13)					(28.35)						(93)
RHC90-2C	C	530 (20.87)	430 (16.93)	750	720	285	145	2	15 (0.59)	15 (0.59)	44							
RHC90-2C				680	580	880	850	360			220	3	(97)					
460 V class series	RHC7.5-4C	A	250 (9.84)	226 (8.90)	380	358	245 (9.65)	125 (4.92)	2 (0.08)	10 (0.39)	10 (0.39)	12.5 (28)						
	RHC11-4C				(14.96)	(14.09)												
	RHC15-4C				(14.96)	(14.09)												
	RHC18.5-4C	B	340 (13.39)	240 (9.45)	480	460	255 (10.04)	145 (5.71)	2 (0.08)	10 (0.39)	10 (0.39)	24						
	RHC22-4C				(18.90)	(18.11)						(53)						
	RHC30-4C				(21.65)	(20.87)						(64)						
	RHC37-4C				375	275	675					655	270 (10.63)	145 (5.71)	2 (0.08)	10 (0.39)	10 (0.39)	34
	RHC45-4C						(26.57)					(25.79)						(75)
	RHC55-4C				(14.76)	(10.83)	740					720	270 (10.63)	145 (5.71)	2 (0.08)	10 (0.39)	10 (0.39)	38
	RHC75-4C				(29.13)	(28.35)	(84)											
	RHC90-4C	C	530 (20.87)	430 (16.93)	740	710	315	175	2 (0.08)	15 (0.59)	15 (0.59)	39						
	RHC110-4C				(29.13)	(27.95)	(12.40)	(6.89)				(86)						
	RHC132-4C				1000	970	360	220				3 (0.12)	(221)					
	RHC160-4C		(39.37)	(38.19)	(14.17)	(8.66)	15 (0.59)	(309)										
	RHC200-4C		680 (26.77)	580 (22.83)	1400 (55.12)	1370 (53.94)		450 (17.72)	285 (11.22)			4 (0.16)	15 (0.59)	15 (0.59)	320			
	RHC220-4C						(706)											
	RHC280-4C		880 (34.65)	780 (30.71)	1550 (59.84)	1520 (59.84)	500 (19.69)	313 (12.32)	4 (0.16)			15 (0.59)	15 (0.59)	410				
	RHC315-4C													(904)				
	RHC355-4C		D	999 (39.33)	900 (35.43)	1550 (59.84)	1520 (59.84)	500 (19.69)	313 (12.32)			4 (0.16)	15 (0.59)	15 (0.59)	525			
	RHC400-4C	(1157)																
RHC500-4C																		
RHC630-4C																		

< Boosting reactor >

Figure A

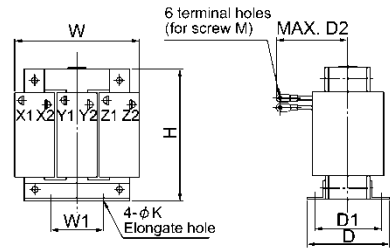

Figure B

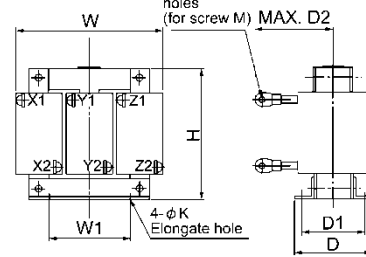

Figure C

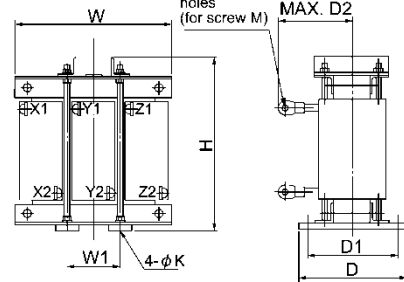
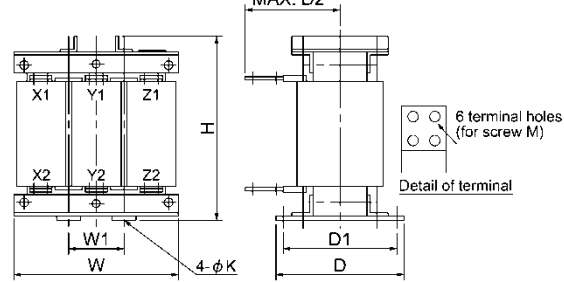
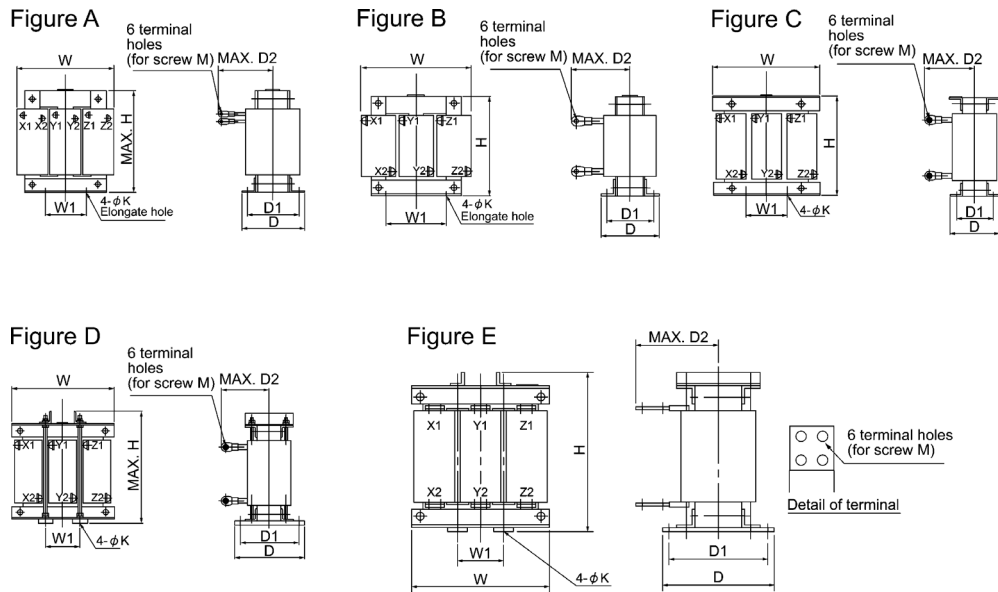

Figure D



Boosting reactor type	Figure	Dimensions inch (mm)								Approx. mass kg (lbs)		
		W	W1	H	D	D1	D2	K	M			
230 V class series	LR2-7.5C	A	180 (7.09)	75 (2.95)	205 (8.07)	105 (4.13)	85 (3.35)	95 (3.74)	7 (0.28)	M5	12 (26)	
	LR2-15C	B	195 (7.68)	75 (2.95)	215 (8.46)	131 (5.16)	110 (4.33)	130 (5.12)	7 (0.28)	M8	18 (40)	
	LR2-22C	C	240 (9.45)	80 (3.15)	340 (13.39)	215 (8.46)	180 (7.09)	145 (5.71)	10 (0.39)	M8	33 (73)	
	LR2-37C		285 (11.22)	95 (3.74)	420 (16.54)	240 (9.45)	205 (8.07)	150 (5.91)	12 (0.47)		M10	50 (110)
	LR2-55C					250 (9.84)	215 (8.46)	160 (6.30)		M12	58 (128)	
	LR2-75C		330 (12.99)	110 (4.33)	440 (17.32)	255 (10.04)	220 (8.66)	165 (6.50)			70 (154)	
	LR2-110C		345 (13.58)	115 (4.53)	500 (19.69)	280 (11.02)	245 (9.65)	185 (7.28)			100 (220)	
460 V class series	LR4-7.5C	B	180 (7.09)	75 (2.95)	205 (8.07)	105 (4.13)	85 (3.35)	90 (3.54)	7 (0.28)	M4	12 (26)	
	LR4-15C	A	195 (7.68)	75 (2.95)	215 (8.46)	131 (5.16)	110 (4.33)	120 (4.72)	7 (0.28)	M5	18 (40)	
	LR4-22C	C	240 (9.45)	80 (3.15)	340 (13.39)	215 (8.46)	180 (7.09)	120 (4.72)	10 (0.39)	M6	33 (73)	
	LR4-37C		285 (11.22)	95 (3.74)	405 (15.94)	240 (9.45)	205 (8.07)	130 (5.12)	12 (0.47)		M8	50 (110)
	LR4-55C				415 (16.34)	250 (9.84)	215 (8.46)	145 (5.71)		M10		58 (128)
	LR4-75C		330 (12.99)	110 (4.33)	440 (17.32)	255 (10.04)	220 (8.66)	150 (5.91)				70 (154)
	LR4-110C		345 (13.58)	115 (4.53)	490 (19.29)	280 (11.02)	245 (9.65)	170 (6.69)		M12	100 (220)	
	LR4-160C		380 (14.96)	125 (4.92)	550 (21.65)	300 (11.81)	260 (10.24)	185 (7.28)	15 (0.59)			140 (309)
	LR4-220C		450 (17.72)	150 (5.91)	620 (24.41)	330 (12.99)	290 (11.42)	230 (9.06)		M16	200 (441)	
	LR4-280C		480 (18.90)	160 (6.30)	740 (29.13)			240 (9.45)			250 (551)	
	LR4-315C				760 (29.92)	340 (13.39)	300 (11.81)	250 (9.84)			270 (595)	
	LR4-355C				830 (32.68)	355 (13.98)	315 (12.40)	255 (10.04)		310 (683)		
	LR4-400C			890 (35.04)	380 (14.96)	330 (12.99)	260 (10.24)	19 (0.75)		340 (750)		
	LR4-500C		525 (20.67)	175 (6.89)	960 (37.80)	410 (16.14)	360 (14.17)	290 (11.42)		420 (926)		
	LR4-630C	D	600 (23.62)	200 (7.87)	640 (25.20)	440 (17.32)	390 (15.35)	290 (11.42)	19 (0.75)	4×M12	450 (992)	

< Filtering reactor >



Filtering reactor type		Figure	Dimensions mm (inch)								Approx. mass kg (lbs)				
			W	W1	H	D	D1	D2	K	M					
230 V class series	LFC2-7.5C	B	125 (4.92)	40 (1.57)	100 (3.94)	85 (3.35)	67 (2.64)	85 (3.35)	6 (0.24)	M5	2.2 (4.9)				
	LFC2-15C					93 (3.66)	75 (2.95)	90 (3.54)		2.5 (5.5)					
	LFC2-22C					105 (4.13)	125 (4.96)	3.0 (6.6)							
	LFC2-37C		150 (5.91)	60 (2.36)	115 (4.53)	103 (4.06)	85 (3.35)	140 (5.51)		M10	5.0 (11)				
	LFC2-55C		175 (6.89)	80 (3.15)	145 (5.71)	110 (4.33)	90 (3.54)	150 (5.91)		M12	8.0 (18)				
	LFC2-75C		195 (7.68)	200 (7.87)	120 (4.72)	100 (3.94)	150 (5.91)	7 (0.28)		13 (29)					
	LFC2-110C	C	255 (10.04)	85 (3.35)	230 (9.06)	118 (4.65)	95 (3.74)	165 (6.50)	7 (0.28)	M12	20 (44)				
460 V class series	LFC4-7.5C	A	125 (4.92)	40 (1.57)	100 (3.94)	85 (3.35)	67 (2.64)	75 (2.95)	6 (0.24)	M4	2.2 (4.9)				
	LFC4-15C					93 (3.66)	75 (2.95)	90 (3.54)		M5	2.5 (5.5)				
	LFC4-22C					95 (3.74)	110 (4.33)	3.0 (6.6)							
	LFC4-37C	B	150 (5.91)	60 (2.36)	115 (4.53)	108 (4.25)	90 (3.54)	110 (4.33)	6 (0.24)	M8	5.0 (11)				
	LFC4-55C					110 (4.33)	120 (4.72)	8.0 (18)							
	LFC4-75C					113 (4.45)	130 (5.12)	12 (26)							
	LFC4-110C	C	255 (10.04)	85 (3.35)	220 (8.66)	113 (4.45)	90 (3.54)	145 (5.71)	7 (0.28)	M12	19 (42)				
	LFC4-160C				245 (9.65)	137 (5.39)	110 (4.33)	150 (5.91)	10 (0.39)		22 (49)				
	LFC4-220C	D	300 (11.81)	100 (3.94)	320 (12.60)	210 (8.27)	180 (7.09)	170 (6.69)	10 (0.39)	M12	35 (77)				
	LFC4-280C				330 (12.99)	110 (4.33)	320 (12.60)	230 (9.06)	195 (7.68)		43 (95)				
	LFC4-315C				315 (12.40)	105 (4.13)	365 (14.37)	235 (9.25)	200 (7.87)		200 (7.87)	12 (0.47)	M16	48 (106)	
	LFC4-355C						395 (15.55)		210 (8.27)		53 (117)				
	LFC4-400C				345 (13.58)	115 (4.53)	420 (16.54)	240 (9.45)	205 (8.07)		240 (9.45)	235 (9.25)	15 (0.59)	4×M12	60 (132)
	LFC4-500C						480 (18.90)		240 (9.45)		72 (159)				
LFC4-630C	550 (21.65)						295 (11.61)		205 (8.07)		175 (386)				

< Filtering capacitor >

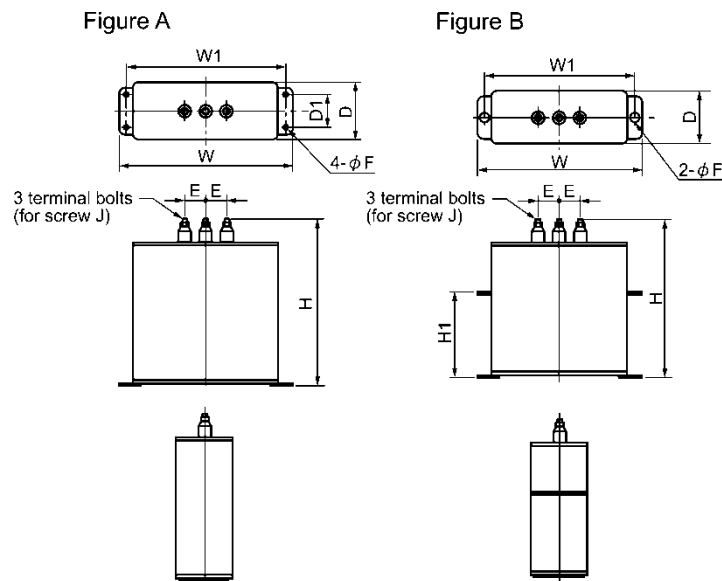

Filtering capacitor type	Figure	Dimensions mm (inch)									Approx. mass kg (lbs)
		W	W1	H	H1	D	D1	E	F	J	
230 V class series	CF2-7.5C	165 (6.50)	150 (5.91)	185 (7.28)	-	70 (2.76)	40 (1.57)	30 (1.18)	7 (0.28)	M5	1.9 (4.2)
	CF2-15C	205 (8.07)	190 (7.48)	245 (9.65)							3.5 (7.7)
	CF2-22C			215 (8.46)							5.5 (12)
	CF2-37C			235 (9.25)							6.0 (13)
	CF2-55C	280 (11.02)	265 (10.43)	340 (13.39)							8.5 (19)
	CF2-75C			235 (9.25)							6.0 (13)
	CF2-110C			340 (13.39)							8.5 (19)
460 V class series	CF4-7.5C	165 (6.50)	150 (5.91)	135 (5.31)	-	70 (2.76)	40 (1.57)	30 (1.18)	7 (0.28)	M5	1.3 (2.9)
	CF4-15C			215 (8.46)							2.3 (5.1)
	CF4-22C			185 (7.28)							2.5 (5.5)
	CF4-37C			205 (8.07)							2.9 (6.4)
	CF4-55C			245 (9.65)							3.5 (7.7)
	CF4-75C			205 (8.07)							2.9 (6.4)
	CF4-110C			245 (9.65)							3.5 (7.7)
	CF4-160C	280 (11.02)	265 (10.43)	260 (10.24)	90 (3.54)	55 (2.17)	80 (3.15)	M6	6.0 (13)		
	CF4-220C	435 (17.13)	400 (15.75)	310 (12.20)	125 (4.92)	100 (3.94)	-	80 (3.15)	15x20 (0.59x0.79)	M12	13 (29)
	CF4-280C			350 (13.78)	165 (6.50)						15 (33)
	CF4-315C			460 (18.11)	275 (10.83)						20 (44)
	CF4-355C			520 (20.47)	335 (13.19)						23 (51)
	CF4-400C			610 (24.02)	425 (16.73)						27 (60)
	CF4-500C *2			310 (12.20)	125 (4.92)						13 (29)
CF4-630C *2	460 (18.11)			275 (10.83)	20 (44)						

*1 Elongate hole

*2 The CF4-500C/CF4-630C consists of two pieces of capacitors. For an order of quantity "1," two pieces of capacitors are to be delivered.

< Filtering resistor >

Figure A

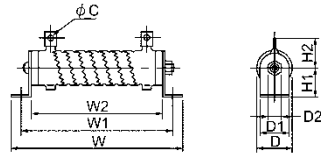

Figure B

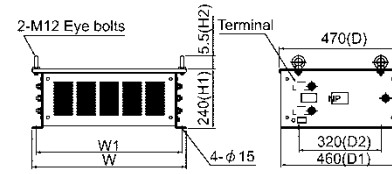
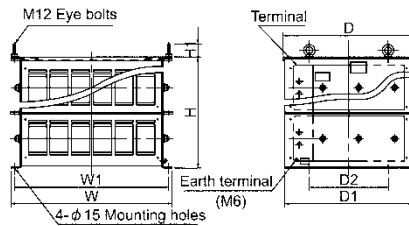

Figure C



Filtering resistor type		Figure	Dimensions mm(inch)								Approx. mass kg (lbs)	
			W	W1	W2	H1	H2	D	D1	D2		C
230 V class series	GRZG80 0.42Ω	A	167 (6.57)	148 (5.83)	115 (4.53)	-	32 (1.26)	33 (1.30)	26 (1.02)	6 (0.24)	5.5 (0.22)	0.19 (0.4)
	GRZG150 0.2Ω		247 (9.72)	228 (8.98)	195 (7.68)		22 (0.87)					
	GRZG200 0.13Ω		306 (12.05)	287 (11.30)	254 (10.00)	40 (1.57)	46 (1.81)	47 (1.85)	40 (1.57)	9.5 (0.37)	8.2 (0.32)	0.35 (0.8)
	GRZG400 0.1Ω		411 (16.18)	385 (15.16)	330 (12.99)							
	GRZG400 0.12Ω											
460 V class series	GRZG80 1.74Ω	A	167 (6.57)	148 (5.83)	115 (4.53)	-	32 (1.26)	33 (1.30)	26 (1.02)	6 (0.24)	5.5 (0.22)	0.19 (0.4)
	GRZG150 0.79Ω		247 (9.72)	228 (8.98)	195 (7.68)		22 (0.87)					
	GRZG200 0.53Ω		306 (12.05)	287 (11.30)	254 (10.00)	40 (1.57)	46 (1.81)	47 (1.85)	40 (1.57)	9.5 (0.37)	8.2 (0.32)	0.35 (0.8)
	GRZG400 0.38Ω		411 (16.18)	385 (15.16)	330 (12.99)							
	GRZG400 0.26Ω											
	GRZG400 0.53Ω											
	RF4-160C	B	400 (15.75)	370 (14.57)	-	240 (9.45)	55 (2.17)	470 (18.50)	460 (18.11)	320 (12.60)	-	22 (49)
	RF4-220C										25 (55)	
	RF4-280C	C	655 (25.79)	625 (24.61)	-	240 (9.45)	55 (2.17)	470 (18.50)	460 (18.11)	320 (12.60)	-	31 (68)
	RF4-315C											
	RF4-355C									36 (79)		
	RF4-400C									38 (84)		
	RF4-500C									41 (90)		
RF4-630C								440 (17.32)		530 (20.87)		520 (20.47)

< Charging box >

The charging box contains a combination of a charging resistor and a fuse, which is essential in the configuration of the RHC-C series of PWM converters. Using this charging box eases mounting and wiring jobs.

Capacity range

230 V class series: 7.5 to 90 kW (10 to 125 HP) in 10 types,

460 V class series: 7.5 to 220 kW (10 to 350 HP) in 14 types.

As for 400 V class series with a capacity of 280 to 630 kW, a charging resistor and a fuse are separately provided as before.

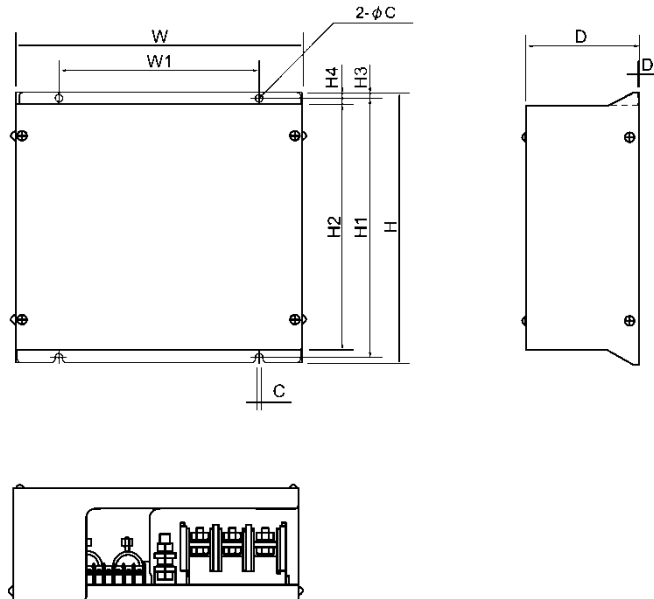

Charging box type		Dimensions mm (inch)									Mounting bolt	Approx. mass kg(lbs)	
		W	W1	H	H1	H2	H3	4	D	D1			C
230 V class series	CU7.5-2C	270 (10.63)	170 (6.69)	300 (11.81)	285 (11.22)	270 (10.63)	7.5 (0.30)	15 (0.59)	100 (3.94)	2.4 (0.09)	6 (0.24)	M5	6 (13)
	CU11-2C												
	CU15-2C												
	CU18.5-2C												
	CU22-2C												
	CU30-2C	300 (11.81)	200 (7.87)	310	295 (11.61)	280 (11.02)	110 (4.33)	130 (5.12)	7 (15)				
	CU45-2C	330 (12.99)	230 (9.06)							8 (18)			
	CU55-2C	430 (16.93)	330 (12.99)	560 (22.05)	536 (21.10)	510 (20.08)	12 (0.47)	25 (0.98)	150 (5.91)		3.2 (0.13)	10 (0.39)	M8
	CU90-2C									20 (44)			
460 V class series	CU7.5-4C	270 (10.63)	170 (6.69)	300 (11.81)	285 (11.22)	270 (10.63)	7.5 (0.30)	15 (0.59)	100 (3.94)	2.4 (0.09)	6 (0.24)	M5	5.5 (12)
	CU15-4C												
	CU18.5-4C												
	CU22-4C												
	CU30-4C	300 (11.81)	200 (7.87)	310	295 (11.61)	280 (11.02)	110 (4.33)	130 (5.12)	7 (15)				
	CU45-4C									8 (18)			
	CU55-4C	330 (12.99)	230 (9.06)	560 (22.05)	536 (21.10)	510 (20.08)	12 (0.47)	25 (0.98)	150 (5.91)		3.2 (0.13)	10 (0.39)	M8
	CU75-4C												
	CU90-4C	430 (16.93)	330 (12.99)	560 (22.05)	536 (21.10)	510 (20.08)	12 (0.47)	25 (0.98)	150 (5.91)	3.2 (0.13)	10 (0.39)	M8	20 (44)
	CU110-4C												
	CU132-4C												
	CU160-4C												
	CU200-4C	20 (44)											
	CU220-4C												

< Charging resistor >

Figure A

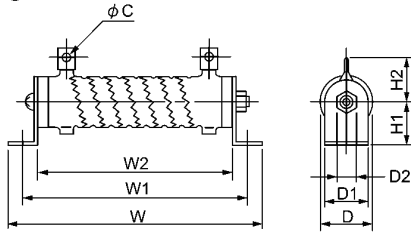

Figure B

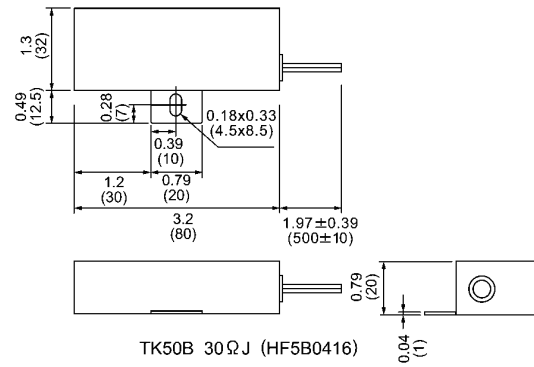
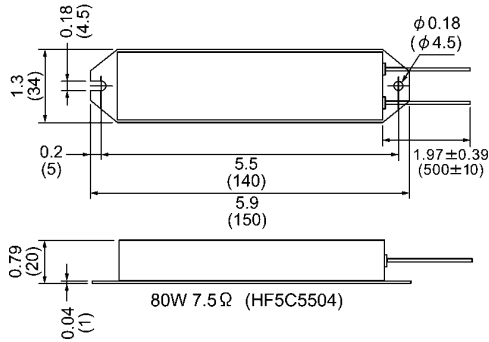

Figure C



Charging resistor type	Figure	Dimensions mm (inch)									Approx. mass kg(lbs)
		W	W1	W2	H1	H2	D	D1	D2	C	
GRZG120 2Ω	A	217 (8.54)	198 (7.80)	165 (6.50)	22 (0.87)	32 (1.26)	33 (1.30)	22 (0.87)	6 (0.24)	5.5 (0.22)	0.25 (0.6)
GRZG400 1Ω	A	411 (16.18)	385 (15.16)	330 (12.99)	40 (1.57)	39 (1.54)	47 (1.85)	40 (1.57)	9.5 (0.37)	5.5 (0.22)	0.85 (1.9)
TK50B 30ΩJ (HF5B0416)	B	-	-	-	-	-	-	-	-	-	0.15 (0.3)
80W 7.5Ω (HF5C5504)	C	-	-	-	-	-	-	-	-	-	0.19 (0.4)

< Fuse >

Figure A

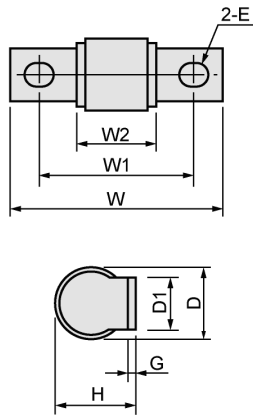

Figure B

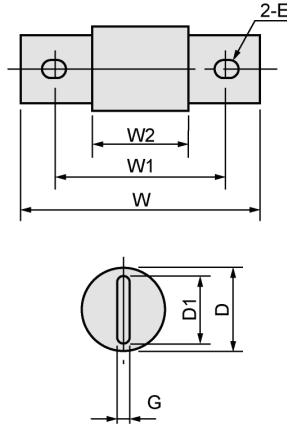
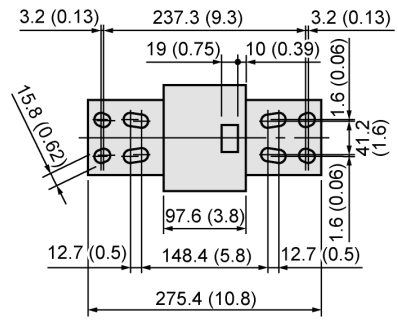
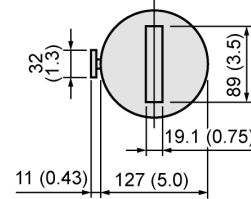

Figure C



Side view of A70P1600-4TA



Side view of A70P2000-4

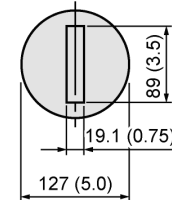

Fuse type	Figure	Dimensions mm(inch)								Approx. mass kg (lbs)	
		W	W1	W2	H	D	D1	G	E		
230 V class series	CR2LS-50/UL	A	56 (2.20)	42 (1.65)	26 (1.02)	18.5 (0.73)	17.5 (0.69)	12 (0.47)	2 (0.08)	6.5x8.5 (0.26x0.33)	0.03 (0.1)
	CR2LS-75/UL		80 (3.15)	58 (2.28)	29.5 (1.16)	30.5 (1.20)	27 (1.06)	20 (0.79)	3 (0.12)	9x11 (0.35x0.43)	0.10 (0.2)
	CR2LS-100/UL		85 (3.35)	60 (2.36)	30 (1.18)	33.5 (1.32)	30 (1.18)	25 (0.98)	3.2 (0.13)	11x13 (0.43x0.51)	0.13 (0.3)
	CR2L-150/UL		95 (3.74)	70 (2.76)	31 (1.22)	42 (1.65)	37 (1.46)	30 (1.18)	4 (0.16)	11x13 (0.43x0.51)	0.22 (0.5)
	CR2L-200/UL		113.5 (4.47)	81.75 (3.22)	56.4 (2.22)	-	50.8 (2.00)	38.1 (1.50)	6.4 (0.25)	10.3x18.2 (0.41x0.72)	0.60 (1.3)
	CR2L-260/UL		76 (2.99)	62 (2.44)	47 (1.85)	18.5 (0.73)	17.5 (0.69)	12 (0.47)	2 (0.08)	6.5x8.5 (0.26x0.33)	0.04 (0.1)
460 V class series	A50P600-4	A	95 (3.74)	70 (2.76)	40 (1.57)	34 (1.34)	30 (1.18)	25 (0.98)	3.2 (0.13)	11x13 (0.43x0.51)	0.15 (0.3)
	CR6L-30/UL		107 (4.21)	82 (3.23)	43 (1.69)	42 (1.65)	37 (1.46)	30 (1.18)	4 (0.16)	11x13 (0.43x0.51)	0.25 (0.6)
	CR6L-50/UL		110 (4.33)	78.6 (3.09)	53.1 (2.09)	-	38.1 (1.50)	25.4 (1.00)	6.4 (0.25)	10.3x18.4 (0.41x0.72)	0.30 (0.7)
	CR6L-75/UL		113.5 (4.47)	81.75 (3.22)	56.4 (2.22)	-	50.8 (2.00)	38.1 (1.50)	6.4 (0.25)	10.3x18.2 (0.41x0.72)	0.60 (1.3)
	CR6L-100/UL		180.2 (7.09)	129.4 (5.09)	72.2 (2.84)	-	63.5 (2.50)	50.8 (2.00)	9.5 (0.37)	13.5x18.3 (0.53x0.72)	1.1 (2.4)
	CR6L-150/UL		-	-	-	-	-	-	-	-	8.0 (18)
	CR6L-200/UL	-	-	-	-	-	-	-	-	8.0 (18)	
	CR6L-300/UL	-	-	-	-	-	-	-	-	-	
	A50P400-4	B	-	-	-	-	-	-	-	-	-
	A50P600-4		-	-	-	-	-	-	-	-	-
A70QS800-4	C	-	-	-	-	-	-	-	-	-	
A70P1600-4T	C	-	-	-	-	-	-	-	-	-	
A70P2000-4		-	-	-	-	-	-	-	-	-	

Generated loss

In CT mode

PWM converter		Boosting reactor		Filtering reactor		Filtering resistor		
Type	Generated loss (W)	Type	Generated loss (W)	Type	Generated loss (W)	Type	Q'ty	Generated loss (W) *
RHC7.5-2C	400	LR2-7.5C	95	LFC2-7.5C	10	GRZG80 0.42Ω	3	16
RHC11-2C	500	LR2-15C	150	LFC2-15C	19	GRZG150 0.2Ω	3	48
RHC15-2C	650							
RHC18.5-2C	700	LR2-22C	230	LFC2-22C	26	GRZG200 0.13Ω	3	68
RHC22-2C	800							
RHC30-2C	1000	LR2-37C	330	LFC2-37C	32	GRZG400 0.1Ω	3	107
RHC37-2C	1350							240
RHC45-2C	1500	LR2-55C	450	LFC2-55C	43	GRZG400 0.1Ω	3	137
RHC55-2C	1750							374
RHC75-2C	2050	LR2-75C	520	LFC2-75C	74	GRZG400 0.12Ω (2 parts in parallel)	6	374
RHC90-2C	2450	LR2-110C	720	LFC2-110C	115	GRZG400 0.12Ω (2 parts in parallel)	6	374
RHC7.5-4C	400	LR4-7.5C	90	LFC4-7.5C	9	GRZG80 1.74Ω	3	15
RHC11-4C	500	LR4-15C	160	LFC4-15C	20	GRZG150 0.79Ω	3	48
RHC15-4C	600							
RHC18.5-4C	650	LR4-22C	230	LFC4-22C	22	GRZG200 0.53Ω	3	70
RHC22-4C	900							
RHC30-4C	1200	LR4-37C	350	LFC4-37C	36	GRZG400 0.38Ω	3	86
RHC37-4C	1550							
RHC45-4C	1800	LR4-55C	490	LFC4-55C	43	GRZG400 0.26Ω	3	130
RHC55-4C	2050							
RHC75-4C	2150	LR4-75C	520	LFC4-75C	78	GRZG400 0.38Ω	3	112
RHC90-4C	2600	LR4-110C	710	LFC4-110C	90	GRZG400 0.53Ω (2 parts in parallel)	6	405
RHC110-4C	3050							
RHC132-4C	3500	LR4-160C	1000	LFC4-160C	160	RF4-160C	1	568
RHC160-4C	4150							
RHC200-4C	5100	LR4-220C	1240	LFC4-220C	200	RF4-220C	1	751
RHC220-4C	5600							
RHC280-4C	7100	LR4-280C	1430	LFC4-280C	220	RF4-280C	1	1027
RHC315-4C	8000	LR4-315C	1660	LFC4-315C	260	RF4-315C	1	1154
RHC355-4C	8900	LR4-355C	1910	LFC4-355C	300	RF4-355C	1	1286
RHC400-4C	10100	LR4-400C	2160	LFC4-400C	350	RF4-400C	1	1454

* Generated loss of the filtering resistor listed in the above table is a total value of all filtering resistors used.

In VT mode

PWM converter		Boosting reactor		Filtering reactor		Filtering resistor		
Type	Generated loss (W)	Type	Generated loss (W)	Type	Generated loss (W)	Type	Q'ty	Generated loss (W) *
RHC7.5-2C	450	LR2-15C	150	LFC2-15C	19	GRZG150 0.2Ω	3	48
RHC11-2C	550							
RHC15-2C	650	LR2-22C	230	LFC2-22C	26	GRZG200 0.13Ω	3	68
RHC18.5-2C	750							
RHC22-2C	850	LR2-37C	330	LFC2-37C	32	GRZG400 0.1Ω	3	107
RHC30-2C	1200							
RHC37-2C	1500	LR2-55C	450	LFC2-55C	43	GRZG400 0.1Ω	3	240
RHC45-2C	1600							
RHC55-2C	2100	LR2-75C	520	LFC2-75C	74			137
RHC75-2C	2300	LR2-110C	720	LFC2-110C	115	GRZG400 0.12Ω (2 parts in parallel)	6	374
RHC90-2C	2650							
RHC7.5-4C	400	LR4-15C	160	LFC4-15C	20	GRZG150 0.79Ω	3	48
RHC11-4C	500							
RHC15-4C	600	LR4-22C	230	LFC4-22C	22	GRZG200 0.53Ω	3	70
RHC18.5-4C	600							
RHC22-4C	950	LR4-37C	350	LFC4-37C	36	GRZG400 0.38Ω	3	86
RHC30-4C	1200							
RHC37-4C	1450	LR4-55C	490	LFC4-55C	43	GRZG400 0.26Ω	3	130
RHC45-4C	1750							
RHC55-4C	2250	LR4-75C	520	LFC4-75C	78	GRZG400 0.38Ω	3	112
RHC75-4C	1950	LR4-110C	710	LFC4-110C	90	GRZG400 0.53Ω (2 parts in parallel)	6	405
RHC90-4C	2400							
RHC110-4C	2900	LR4-160C	1000	LFC4-160C	160	RF4-160C	1	568
RHC132-4C	3250							
RHC160-4C	4100	LR4-220C	1240	LFC4-220C	200	RF4-220C	1	751
RHC200-4C	4400							
RHC220-4C	5600	LR4-280C	1430	LFC4-280C	220	RF4-280C	1	1027
RHC280-4C	6250	LR4-315C	1660	LFC4-315C	260	RF4-315C	1	1154
RHC315-4C	7000	LR4-355C	1910	LFC4-355C	300	RF4-355C	1	1286
RHC355-4C	8050	LR4-400C	2160	LFC4-400C	350	RF4-400C	1	1454
RHC400-4C	8950	LR4-500C	2470	LFC4-500C	450	RF4-500C	1	1821

* Generated loss of the filtering resistor listed in the above table is a total value of all filtering resistors used.

4.4.1.2 AC reactors (ACRs)

An ACR is effectively used when the power supply is unstabilized (excessive interphase voltage unbalance) or in DC link bus operation (shared PN operation) requiring stable DC power. It is also used for power supply matching and for correction of voltage waveform and input power factor. AC reactors cannot be used with the 575V class series.

□ For power supply matching

- Use an ACR when there are thyristor-driven loads or phase-advancing capacitors are being turned ON/OFF.

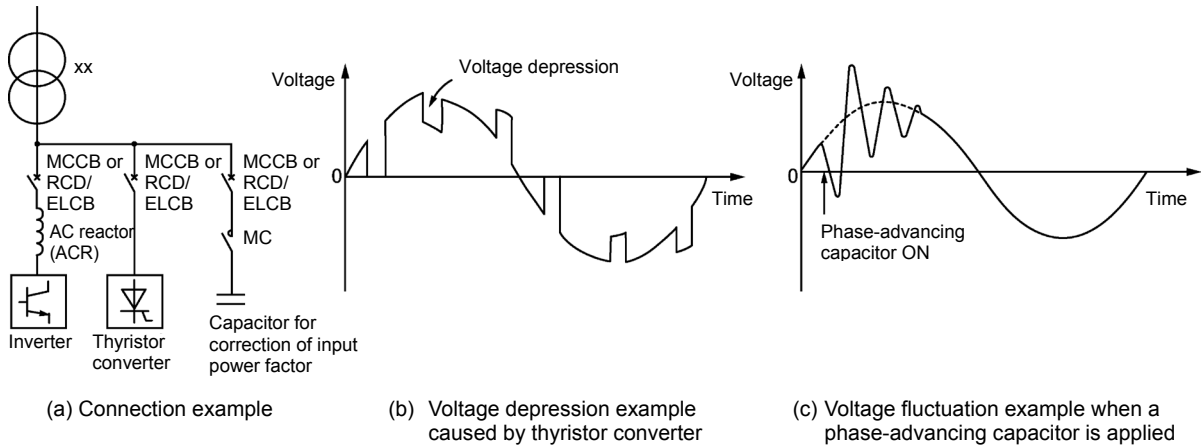

- Use an ACR when the interphase voltage unbalance ratio of the inverter power supply exceeds 2%.

$$\text{Interphase voltage unbalance (\%)} = \frac{\text{Max. voltage (V)} - \text{Min. voltage (V)}}{\text{Three - phase average voltage (V)}} \times 67$$

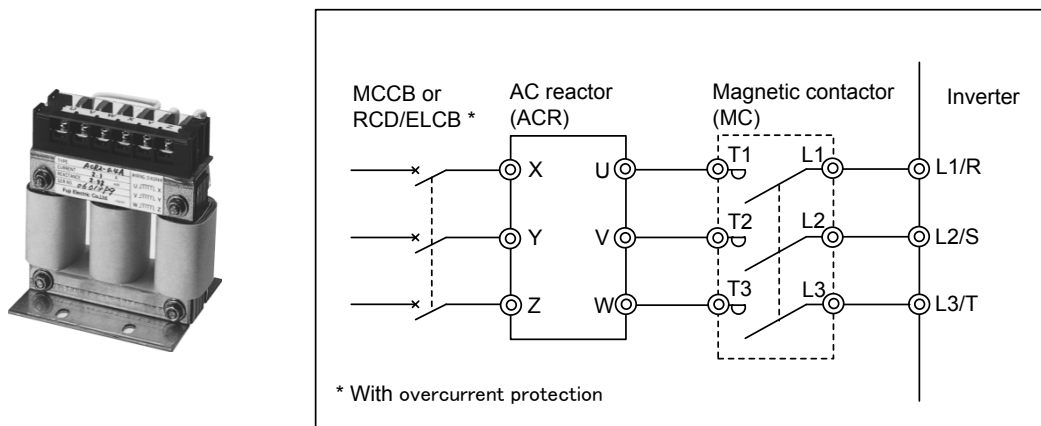

Figure 4.6 External View of AC Reactor (ACR) and Connection Example

Table 4.5 AC Reactor (ACR) Specifications

Power supply voltage	Nominal applied motor (HP)	Inverter type	AC reactor type	Rated current (A)	Reactance (mΩ/phase)		Coil resistance (mΩ)	Generated loss (W)
					50 Hz	60 Hz		
Three-phase 230 V	1	FRN001AR1■-2U	ACR2-0.75A	5	493	592	-	12
	2	FRN002AR1■-2U	ACR2-1.5A	8	295	354	-	14
	3	FRN003AR1■-2U	ACR2-2.2A	11	213	256	-	16
	5	FRN005AR1■-2U	ACR2-3.7A	17	218	153	-	23
	7.5	FRN007AR1■-2U	ACR2-5.5A	25	87.7	105	-	27
	10	FRN010AR1■-2U	ACR2-7.5A	33	65	78	-	30
	15	FRN015AR1■-2U	ACR2-11A	46	45.5	54.7	-	37
	20	FRN020AR1■-2U	ACR2-15A	59	34.8	41.8	-	43
	25	FRN025AR1■-2U	ACR2-18.5A	74	28.6	34.3	-	51
	30	FRN030AR1■-2U	ACR2-22A	87	24	28.8	-	57
	40	FRN040AR1■-2U	ACR2-37	200	10.8	13	0.5	28.6
	50	FRN050AR1■-2U	ACR2-37	200	10.8	13	0.5	40.8
	60	FRN060AR1■-2U	ACR2-55	270	7.5	9	0.375	47.1
	75	FRN075AR1S-2U	ACR2-55	270	7.5	9	0.375	66.1
	100	FRN100AR1S-2U	ACR2-75	390	5.45	6.54	0.25	55.1
125	FRN125AR1S-2U	ACR2-90	450	4.73	5.67	0.198	61.5	

Note 1: A box (■) replaces an alphabetic letter depending on the enclosure.
M (NEMA/UL TYPE 1) or L (NEMA/UL TYPE 12)

Note 2: Generated losses listed in the above table are approximate values that are calculated according to the following conditions:

- The power supply is three-phase 200 V 50 Hz with 0% interphase voltage unbalance ratio.
- The power supply capacity uses the larger of either 500 kVA or 10 times the rated capacity of the inverter.
- The motor is a 4-pole standard model at full load (100%).

Table 4.5 AC Reactor (ACR) Specifications (Continued)

Power supply voltage	Nominal applied motor (HP)	Inverter type	AC reactor type	Rated current (A)	Reactance (mΩ/phase)		Coil resistance (mΩ)	Generated loss (W)
					50 Hz	60 Hz		
Three-phase 460 V	1	FRN001AR1■-4U	ACR4-0.75A	2.5	1920	2300	-	10
	2	FRN002AR1■-4U	ACR4-1.5A	3.7	1160	1390	-	11
	3	FRN003AR1■-4U	ACR4-2.2A	5.5	851	1020	-	14
	5	FRN005AR1■-4U	ACR4-3.7A	9	512	615	-	17
	7.5	FRN007AR1■-4U	ACR4-5.5A	13	349	418	-	22
	10	FRN010AR1■-4U	ACR4-7.5A	18	256	307	-	27
	15	FRN015AR1■-4U	ACR4-11A	24	183	219	-	40
	20	FRN020AR1■-4U	ACR4-15A	30	139	167	-	46
	25	FRN025AR1■-4U	ACR4-18.5A	39	114	137	-	57
	30	FRN030AR1■-4U	ACR4-22A	45	95.8	115	-	62
	40	FRN040AR1■-4U	ACR4-37	100	41.7	50	2.73	38.9
	50	FRN050AR1■-4U	ACR4-37	100	41.7	50	2.73	55.7
	60	FRN060AR1■-4U	ACR4-55	135	30.8	37	1.61	50.2
	75	FRN075AR1■-4U	ACR4-55	135	30.8	37	1.61	70.7
	100	FRN100AR1■-4U	ACR4-75 *1	160	25.8	31	1.16	65.3
	125	FRN125AR1■-4U	ACR4-110	250	16.7	20	0.523	42.2
	150	FRN150AR1S-4U	ACR4-110	250	16.7	20	0.523	60.3
	200	FRN200AR1S-4U	ACR4-132 *1	270	20.8	25	0.741	119
	250	FRN250AR1S-4U	ACR4-220	561	10	12	0.236	56.4
	300	FRN300AR1S-4U	ACR4-220	561	10	12	0.236	90.4
350	FRN350AR1S-4U	ACR4-220	561	10	12	0.236	107	
450	FRN450AR1S-4U	ACR4-280	825	6.67	8	0.144	108	
500	FRN500AR1S-4U	ACR4-355 *1	825	6.67	8	0.144	245	
600	FRN600AR1S-4U	ACR4-450	950	6.67	8	0.136	380	
800	FRN800AR1S-4U	ACR4-530	1100	5.75	6.9	0.0824	340	
900	FRN900AR1S-4U	ACR4-630	1300	4.87	5.84	0.0713	422	
1000	FRN1000AR1S-4U	Not available	-	-	-	-	-	

*1 Fan cooling (3 m/s or more) is required.

Note 1: A box (■) replaces an alphabetic letter depending on the enclosure.
M (NEMA/UL TYPE 1) or L (NEMA/UL TYPE 12)

Note 2: Generated losses listed in the above table are approximate values that are calculated according to the following conditions:

- The power supply is three-phase 400 V 50 Hz with 0% interphase voltage unbalance ratio.
- The power supply capacity uses the larger of either 500 kVA or 10 times the rated capacity of the inverter.
- The motor is a 4-pole standard model at full load (100%).

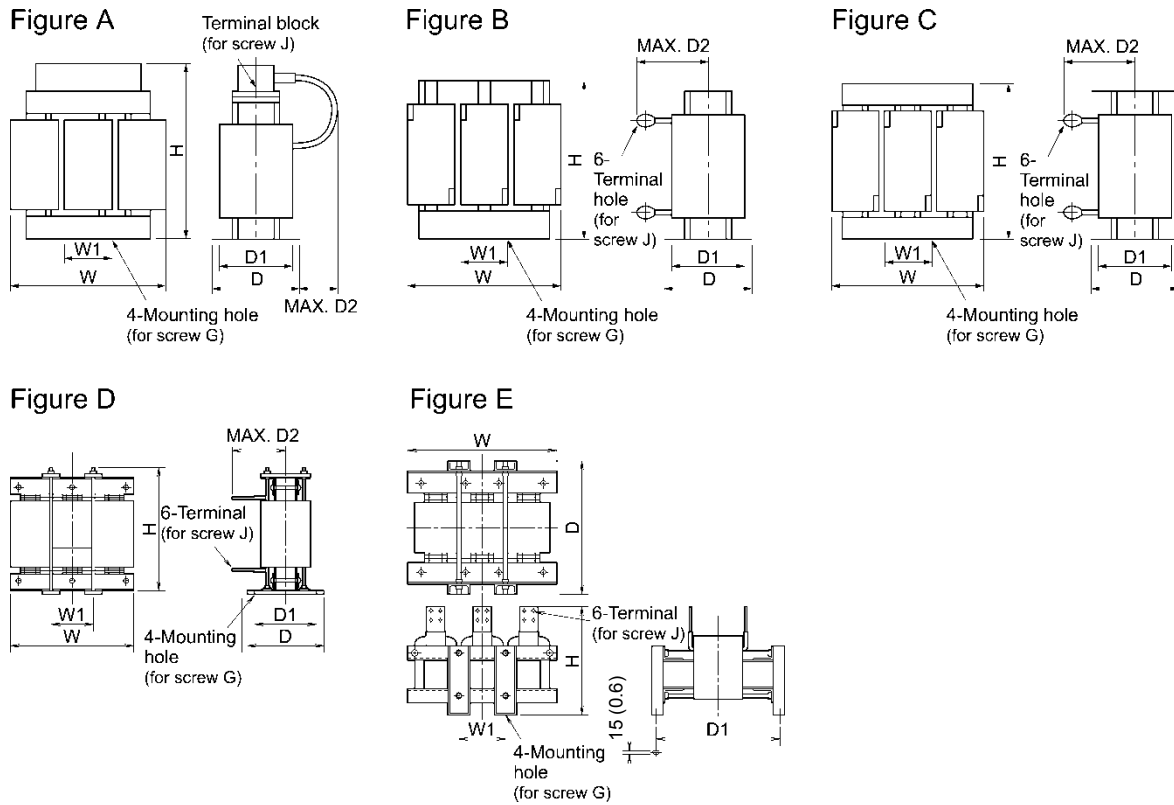

Table 4.6 AC Reactors (ACRs) External Dimensions

Power supply voltage	Nominal applied motor (HP)	Inverter type	AC reactor type	Fig.	Dimensions (mm)								Approx. mass (kg)									
					W	W1	D	D1	D2	Mounting hole G	H	Terminal hole J										
Three-phase 230 V	1	FRN001AR1■-2U	ACR2-0.75A	A	120 (4.72)	40 (1.57)	100 (3.94)	75 (2.95)	20 (0.79)	M5 6×10 (0.24×0.39)	115 (4.53)	M4	1.9 (4.2)									
	2	FRN002AR1■-2U	ACR2-1.5A										2.0 (4.4)									
	3	FRN003AR1■-2U	ACR2-2.2A										2.0 (4.4)									
	5	FRN005AR1■-2U	ACR2-3.7A										2.4 (5.3)									
	7.5	FRN007AR1■-2U	ACR2-5.5A										3.1 (6.8)									
	10	FRN010AR1■-2U	ACR2-7.5A	B	125 (4.92)	40 (1.57)	115 (4.53)	90 (3.54)	106 (4.17)	M5 6×10 (0.24×0.39)	95 (3.74)	M5	3.1 (6.8)									
	15	FRN015AR1■-2U	ACR2-11A										3.7 (8.2)									
	20	FRN020AR1■-2U	ACR2-15A										4.8 (11)									
	25	FRN025AR1■-2U	ACR2-18.5A										5.1 (11)									
	30	FRN030AR1■-2U	ACR2-22A										5.1 (11)									
	40;50	FRN040AR1■-2U FRN050AR1■-2U	ACR2-37										11 (24)									
	60;75	FRN060AR1■-2U FRN075AR1■-2U	ACR2-55										C	190 (7.48)	60 (2.36)	120 (4.72)	90 (3.54)	200 (7.87)	M6; 7×11 (0.28×0.43)	190 (7.48)	M12	13 (29)
	100	FRN100AR1S-2U	ACR2-75																			25 (55)
125	FRN125AR1S-2U	ACR2-90	26 (56)																			

Note: A box (■) replaces an alphabetic letter depending on the enclosure. M (NEMA/UL TYPE 1) or L (NEMA/UL TYPE 12)

Table 4.6 AC Reactors (ACRs) External Dimensions (Continued)

Power supply voltage	Nominal applied motor (HP)	Inverter type	AC reactor type	Fig.	Dimensions (mm)							Approx. mass (kg)						
					W	W1	D	D1	D2	Mounting hole G	H		Terminal hole J					
Three-phase 460 V	1	FRN001AR1■-4U	ACR4-0.75A	B	120 (4.72)	40 (1.57)	90 (3.54)	65 (2.56)	106 (4.17)	M5 6×10 (0.24×0.39)	85 (3.35)	M4	1.1 (2.4)					
	2	FRN002AR1■-4U	ACR4-1.5A		125 (4.92)		100 (3.94)	75 (2.95)					95 (3.74)	M5	1.9 (4.2)			
	3	FRN003AR1■-4U	ACR4-2.2A												2.2 (4.9)			
	5	FRN005AR1■-4U	ACR4-3.7A												2.4 (5.3)			
	7.5	FRN007AR1■-4U	ACR4-5.5A		115 (4.53)		90 (3.54)	106 (4.17)			M6	3.1 (6.8)						
	10	FRN010AR1■-4U	ACR4-7.5A									3.7 (8.2)						
	15	FRN015AR1■-4U	ACR4-11A		180 (7.09)		60 (2.36)	110 (4.33)			85 (3.35)	106 (4.17)	M6 7×11 (0.28×0.43)	115 (4.53)	M6	4.3 (9.5)		
	20	FRN020AR1■-4U	ACR4-15A													137 (5.39)	M6	5.4 (12)
	25	FRN025AR1■-4U	ACR4-18.5A															5.7 (13)
	30	FRN030AR1■-4U	ACR4-22A													5.9 (13)		
	40; 50	FRN040AR1■-4U FRN050AR1■-4U	ACR4-37	190 (7.48)		C			120 (4.72)	90 (3.54)				172 (6.77)	M6; 7×11 (0.28×0.43)	190 (7.48)	M8	12 (27)
	60; 75	FRN060AR1■-4U FRN075AR1■-4U	ACR4-55	190 (7.48)					60 (2.36)	90 (3.54)				200 (7.87)				M6; 7×10 (0.28×0.39)
	100	FRN100AR1■-4U	ACR4-75	250 (9.84)	100 (3.94)		126 (4.96)	157 (6.18)	M8; 9.5×18 (0.37×0.71)	245 (9.65)	M12	16 (35)						
	125; 150	FRN125AR1■-4U FRN150AR1S-4U	ACR4-110				136 (5.35)	105 (4.13)				202 (7.95)	M8; 10×16 (0.39×0.63)	250 (9.84)		24 (53)		
	200	FRN200AR1S-4U	ACR4-132	146 (5.75)	115 (4.53)		207 (8.15)	M10 12×20 (0.47×0.79)	300 (11.81)	32 (71)								
	250; 350	FRN250AR1S-4U FRN300AR1S-4U FRN350AR1S-4U	ACR4-220	320 (12.60)	120 (4.72)		150 (5.91)			110 (4.33)	240 (9.45)	M12	40 (88)					
	450	FRN450AR1S-4U	ACR4-280	380 (14.96)	130 (5.12)		150 (5.91)						260 (10.24)	M12		52 (115)		
	500	FRN500AR1S-4U	ACR4-355							52 (115)								
	600	FRN600AR1S-4U	ACR4-450	D	460 (18.11)		155 (6.10)	290 (11.42)	230 (9.06)	200 (7.87)	M12; φ15 (φ0.59)	490 (19.29)	4×M12	95 (209)				
	800	FRN800AR1S-4U	ACR4-530	E	480 (18.90)		155 (6.10)	420 (16.54)	370 (14.57)	-	M12 15×25 (0.59×0.98)	380 (14.96)	4×M12	100 (221)				
900	FRN900AR1S4U	ACR4-630	510 (20.08)		170 (6.69)	390 (15.35)	110 (243)											

Note: A box (■) replaces an alphabetic letter depending on the enclosure.
M (NEMA/UL TYPE 1) or L (NEMA/UL TYPE 12)

4.4.1.3 DC reactors (DCRs) (Built-in or bundled as standard)

The 230V class series inverters of 60 HP or below and 460V ones of 125 HP or below have a DCR built-in as standard. The 230V class series inverter of 75 HP or above and 460V ones of 150 HP or above have a DCR bundled as standard, so be sure to connect it to the inverter in accordance with the reference wiring diagram.

A DCR has the following effects.

☐ For power supply matching

- Use a DCR when the capacity of a power supply transformer exceeds 500 kVA and is 10 times or more the rated inverter capacity. In this case, the percent reactance of the power supply decreases, and harmonic components and their peak value increase. These factors may break rectifiers or capacitors in the converter section of inverter, or decrease the capacitance of the capacitor (which can shorten the inverter's service life).
- Also use a DCR when there are thyristor-driven loads or when phase-advancing capacitors are being turned ON/OFF.
- Use a DCR when the interphase voltage unbalance ratio of the inverter power supply exceeds 2%.

$$\text{Interphase voltage unbalance (\%)} = \frac{\text{Max. voltage (V)} - \text{Min. voltage (V)}}{\text{Three - phase average voltage (V)}} \times 67$$

☐ For input power factor correction (for suppressing harmonics)

Generally a capacitor is used to improve the power factor of the load, however, it cannot be used in a system that includes an inverter. Using a DCR increases the reactance of inverter's power supply so as to decrease harmonic components on the power supply lines and improve the power factor of inverter. Using a DCR improves the input power factor to approximately 86% to 95%.

Table 4.7 DC Reactors (DCRs)

Power supply voltage	Nominal applied motor (HP)	Inverter type	DC reactor type	Rated current (A)	Inductance (mH)	Generated loss (W)
Three-phase 230 V	75	FRN075AR1S-2U	DCR2-55C	256	0.080	75
	100	FRN100AR1S-2U	DCR2-75C	358	0.050	96
	125	FRN125AR1S-2U	DCR2-90C	431	0.042	100
Three-phase 460 V	150	FRN150AR1S-4U	DCR4-110C	261	0.166	122
	200	FRN200AR1S-4U	DCR4-132C	313	0.148	159
	250	FRN250AR1S-4U	DCR4-160C	380	0.122	185
	300	FRN300AR1S-4U	DCR4-200C	475	0.098	218
	350	FRN350AR1S-4U	DCR4-220C	524	0.087	231
	450	FRN450AR1S-4U	DCR4-280C	649	0.069	270
	500	FRN500AR1S-4U	DCR4-355C	833	0.054	308
	600	FRN600AR1S-4U	DCR4-400C	938	0.048	323
	800	FRN800AR1S-4U	DCR4-500C	1173	0.039	384
	900	FRN900AR1S-4U	DCR-630C	1477	0.031	620
	1000	FRN1000AR1S-4U	DCR-710C	1666	0.028	600

Note 1: Generated losses listed in the above table are approximate values that are calculated according to the following conditions:

- The power supply is three-phase 200V/400 V 50 Hz with 0% interphase voltage unbalance ratio.
- The power supply capacity uses the larger of either 500 kVA or 10 times the rated capacity of the inverter.
- The motor is a 4-pole standard model at full load (100%).
- An AC reactor (ACR) is not connected.

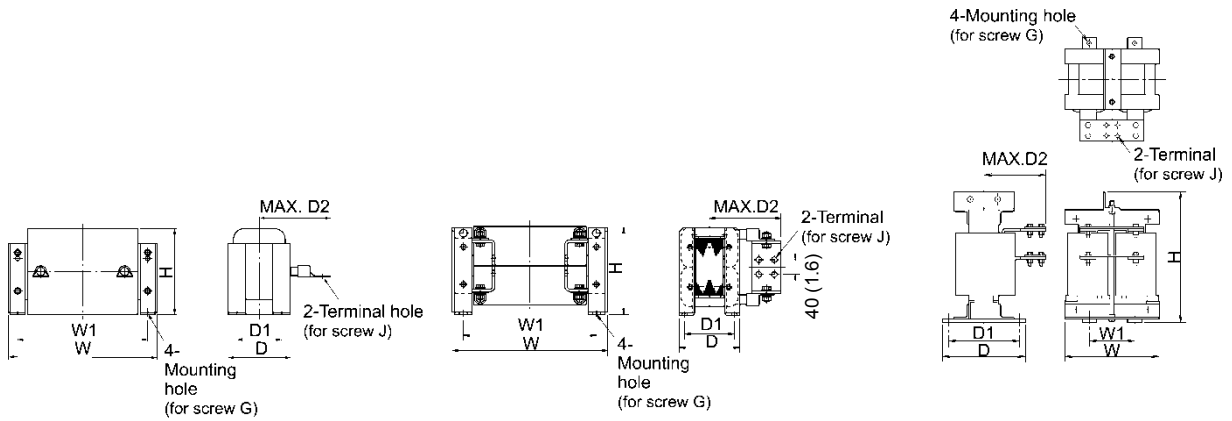

Figure A

Figure B

Figure C

Table 4.8 DC Reactors (DCRs) External Dimensions

Power supply voltage	Nominal applied motor (HP)	Inverter type	AC reactor type	Fig.	Dimensions mm(inch)								Approx. mass kg(lbs)	
					W	W1	D	D1	D2	H	Mounting hole G	Terminal hole J		
Three-phase 230 V	75	FRN075AR1S-2U	DCR2-55C	A	255 (10.04)	225 (8.86)	96 (3.78)	76 (2.99)	140 (5.51)	145 (5.71)	M6 7×13 (0.28×0.51)	M12	11 (24)	
	100	FRN100AR1S-2U	DCR2-75C				106 (4.17)	86 (3.39)	145 (5.71)				12 (27)	
	125	FRN125AR1S-2U	DCR2-90C				116 (4.57)	96 (3.78)	155 (6.10)				14 (31)	
Three-phase 460 V	150	FRN150AR1S-4U	DCR4-110C	A	300 (11.81)	265 (10.43)	116 (4.57)	90 (3.54)	175 (6.89)	155 (6.10)	M8 10×18 (0.39×0.71)	M12	19 (42)	
	200	FRN200AR1S-4U	DCR4-132C				126 (4.96)	100 (3.94)	180 (7.09)				160 (6.30)	22 (49)
	250	FRN250AR1S-4U	DCR4-160C				131 (5.16)	103 (4.06)	180 (7.09)				190 (7.48)	M10 12×22 (0.47×0.87)
	300	FRN300AR1S-4U	DCR4-200C		141 (5.55)	113 (4.45)	185 (7.28)	30 (66)						
	350	FRN350AR1S-4U	DCR4-220C		146 (5.75)	118 (4.65)	200 (7.87)	33 (73)						
	450	FRN450AR1S-4U	DCR4-280C		161 (6.34)	133 (5.24)	210 (8.27)	M16	37 (82)					
	500	FRN500AR1S-4U	DCR4-355C	400 (15.75)	345 (13.58)	156 (6.14)	128 (5.04)		200 (7.87)	225 (8.86)	M10 12×22 (0.47×0.87)	4×M12	49 (108)	
	600	FRN600AR1S-4U	DCR4-400C	455 (17.91)	385 (15.16)	145 (5.71)	117 (4.61)	213 (8.39)	245 (9.65)	52 (115)				
	800	FRN800AR1S-4U	DCR4-500C	445 (17.52)	390 (15.35)	165 (6.50)	137 (5.39)	220 (8.66)	480 (18.90)	M12 14×20 (0.55×0.79)			2×M12	72 (159)
	900	FRN900AR1S-4U	DCR4-630C	285 (11.22)	145 (5.71)	203 (7.99)	170 (6.69)	195 (7.68)			M12 φ15 (φ0.59)	4×M12		75 (165)
1000	FRN1000AR1S-4U	DCR4-710C	340 (13.39)	160 (6.30)	295 (11.61)	255 (10.04)	225 (8.86)	95 (209)						

4.4.1.4 Surge suppression unit (SSU)



If the drive wire for the motor is long, an extremely low surge voltage (micro surge) occurs at the wire end connected to the motor. Surge voltage causes motor degradation, insulation breakdown, or increased noises. The surge suppression unit (SSU) suppresses the surge voltage. It features the connectivity for all motor capacities and easy wiring work. Surge suppression unit cannot be used with the 575V class series.

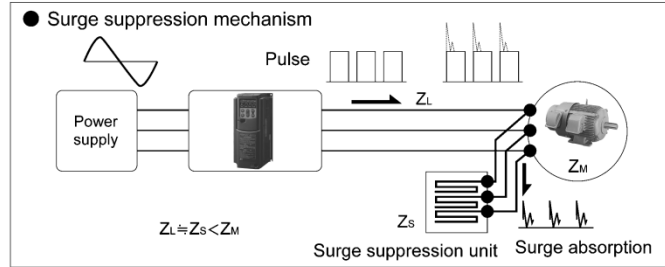

■ Dimensions

- 50 m (164 ft) spec.: SSU 50TA-NS

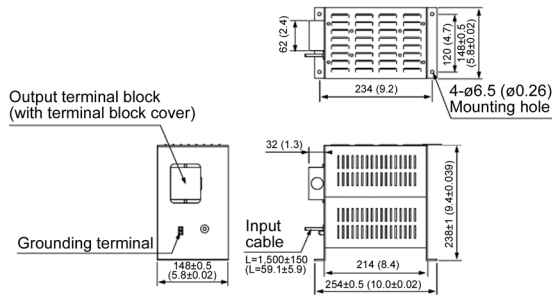

- 100 m (328 ft) spec.: SSU 100TA-NS

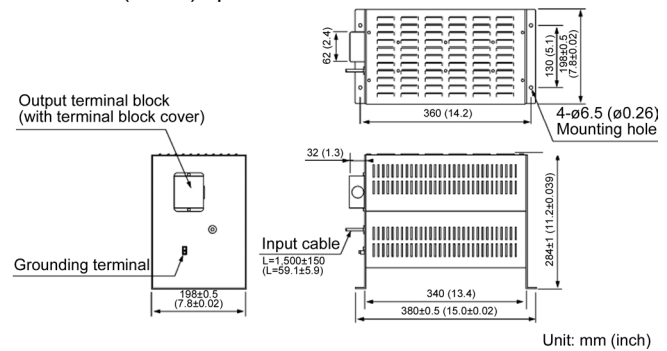

Unit: mm (inch)

■ Effects of installing the surge suppression units (shown by voltage waveform between motors)

Motor/inverter capacity: 3.7kW(5 HP)
 Wiring length: 50 m (164 ft)
 Running status: No-load
 Power supply voltage: Three-phase 400 V

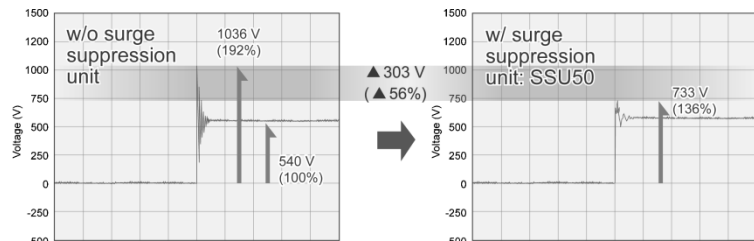

Motor/inverter capacity: 75kW(100 HP)
 Wiring length: 100 m (328 ft)
 Running status: No-load
 Power supply voltage: Three-phase 400 V

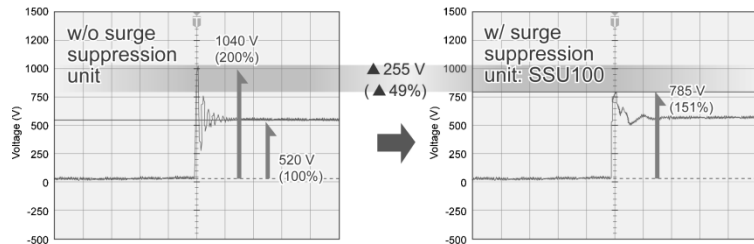

■ Basic specifications

Item	Specifications	
	SSU 50TA-NS	SSU 100TA-NS
Type	SSU 50TA-NS	SSU 100TA-NS
Applicable wiring length	50 m (164 ft) or shorter	100 m (328 ft) or longer
Power supply voltage	200 V and 400 V classes, PWM converter is applicable	
Inverter capacity	75kW(100 HP) or below	
Output frequency	400 Hz or below	
Carrier frequency	15 kHz or below (The SSU is not available at 16 kHz.)	
Enclosure	IP20/ Open type	
Installation environment	Ambient temperature: -20 to +40°C (-4 to 104°F), Relative humidity: 85% RH or below, Vibration: 0.7 G or less, Installation: Horizontally	
Dielectric strength voltage	2500 VAC, 1 minute	

4.4.1.5 Output circuit filters (OFLs)

Insert an OFL in the inverter power output circuit in order to:

- Suppress the surge voltage at motor terminals

This protects the motor from insulation damage caused by the application of high voltage surge currents from the 460 V class series of inverters.

- Suppress line leakage current from the inverter output lines (Leakage current to ground cannot be suppressed.)

This reduces the line leakage current when the motor is connected by long power feed lines. Keep the length of the power feed line less than 400 m (1300 ft).

Output circuit filters cannot be used with the 575V class series.

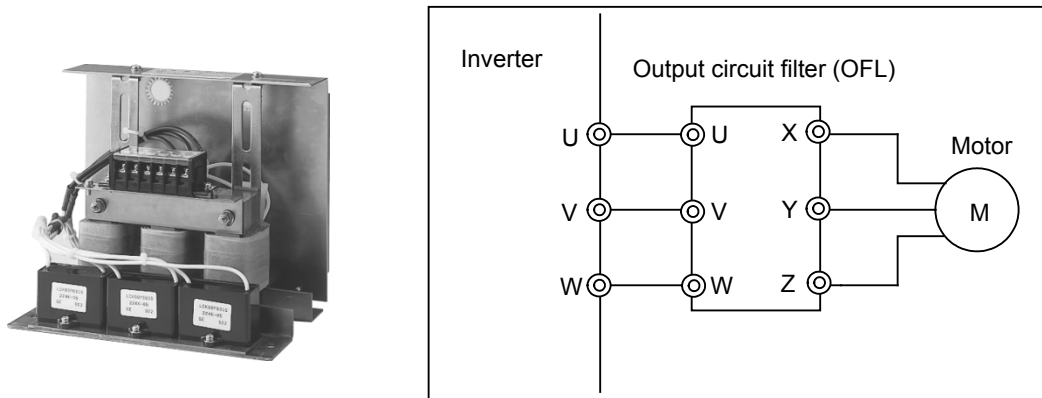

Figure 4.7 External View of Output Circuit Filter (OFL) and Connection Example

Table 4.9 Output Circuit Filter (OFL)

OFL-□□□-4A

Nominal applied motor (HP)	Inverter type	Filter type	Rated current (A)	Overload capability	Inverter power input voltage	Carrier frequency-allowable range (kHz)	Maximum frequency (Hz)	Generated loss (W)
1	FRN001AR1■-4U	OFL-1.5-4A	3.7	150%-1 min 200%-3s	Three-phase 380 to 480 V 50/60 Hz	0.75 to 16 kHz	400 Hz	105
2	FRN002AR1■-4U							
3	FRN003AR1■-4U	OFL-3.7-4A	9					210
5	FRN005AR1■-4U							
7.5	FRN007AR1■-4U	OFL-7.5-4A	18					190
10	FRN010AR1■-4U							
15	FRN015AR1■-4U	OFL-15-4A	30					320
20	FRN020AR1■-4U							
25	FRN025AR1■-4U	OFL-22-4A	45					350
30	FRN030AR1■-4U							
40	FRN040AR1■-4U	OFL-30-4A	60			570		
50	FRN050AR1■-4U	OFL-37-4A	75			610		
60	FRN060AR1■-4U	OFL-45-4A	91			810		
75	FRN075AR1■-4U	OFL-55-4A	112			910		
100	FRN100AR1■-4U	OFL-75-4A	150			1200		
125	FRN125AR1■-4U	OFL-90-4A	176			1360		
150	FRN150AR1S-4U	OFL-110-4A	210			1410		
200	FRN200AR1S-4U	OFL-132-4A	253			1800		
250	FRN250AR1S-4U	OFL-160-4A	304			2210		
300	FRN300AR1S-4U	OFL-200-4A	377			2520		
350	FRN350AR1S-4U	OFL-220-4A	415	2590				
450	FRN450AR1S-4U	OFL-280-4A	520	3570				
500	FRN500AR1S-4U	OFL-355-4A	650	3320				
600	FRN600AR1S-4U	OFL-400-4A	740	3390				
800	FRN800AR1S-4U	OFL-500-4A	960	4250				
900	FRN900AR1S-4U	OFL-630-4A	1170	4700				
1000	FRN1000AR1S-4U	Not available						

Note: A box (■) replaces an alphabetic letter depending on the enclosure.
M (NEMA/UL TYPE 1) or L (NEMA/UL TYPE 12)

OFL-□□□-4A

■ Filter (for OFL-22-4A or below)

Figure A

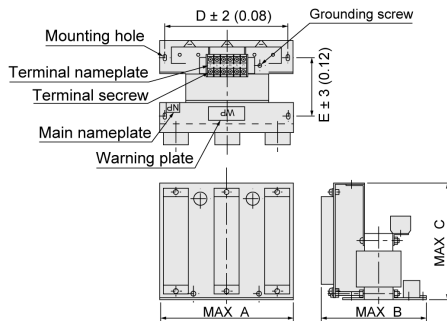
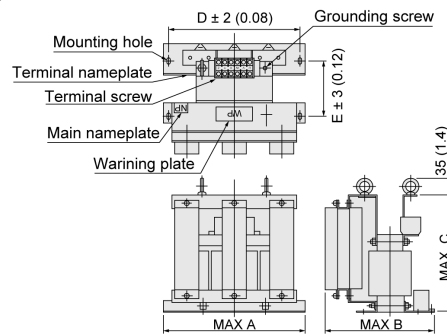
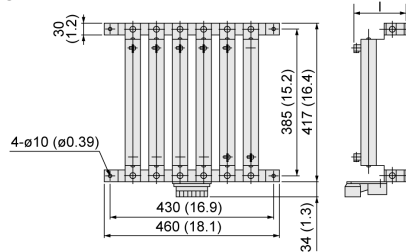

Figure B



■ Resistor and Capacitor (for OFL-30-4A or above)

Figure F



For filters OFL-30-4A or above, a reactor, resistor, and capacitor should be installed separately.
(Those parts are not included in the mass of a filter. If ordered with the filter type, the filter is shipped in combination with a reactor, resistor, and capacitor.)

Figure G

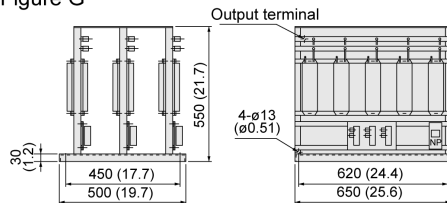

■ Reactor (for OFL-30-4A or above)

Figure C

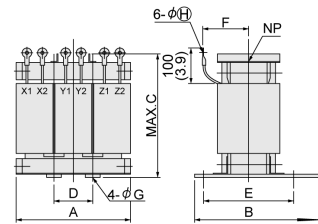

Figure D

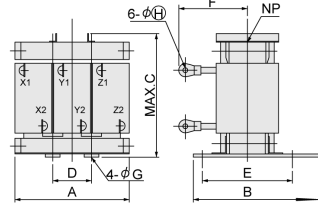
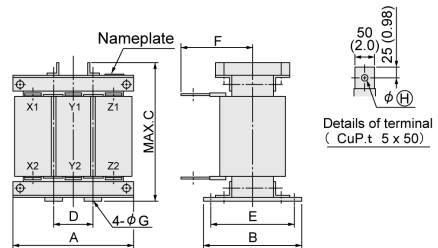

Figure E



unit : mm (inch)

Table 4.10 Output Circuit Filter (OFL) Dimensions

Power supply voltage	Filter type	Dimensions mm (inch)											Approx. mass kg(lbs)
		Fig.	A	B	C	D	E	F	G	Grounding screw H	Terminal screw J	Mounting screw K	
Three-phase 460 V	OFL-1.5-4A	A	220 (8.66)	175 (6.89)	195 (7.68)	200 (7.87)	95 (3.74)	-	-	M4	M4	M5	7 (15)
	OFL-3.7-4A		225 (8.86)	220 (8.66)	115 (4.53)	14 (31)							
	OFL-7.5-4A		290 (11.42)	290 (11.42)	230 (9.06)	260 (10.24)	160 (6.30)						22 (49)
	OFL-15-4A	B	330 (12.99)	275 (10.83)	310 (12.20)	300 (11.81)	145 (5.71)	-	-	M6	M6	M8	35 (77)
	OFL-22-4A		300 (11.81)	330 (12.99)	170 (6.69)	45 (99)							
	OFL-30-4A	C/F	210 (8.27)	175 (6.89)	210 (8.27)	70 (2.76)	140 (5.51)	90 (3.54)	160 (6.30)	-	M5	M6	12 (27)
	OFL-37-4A		220 (8.66)	190 (7.48)	220 (8.66)	75 (2.95)	150 (5.91)	95 (3.74)					15 (33)
	OFL-45-4A	D/F	220 (8.66)	195 (7.68)	265 (10.43)	70 (2.76)	155 (6.10)	140 (5.71)	160 (6.30)	-	M6	M8	17 (38)
	OFL-55-4A		200 (7.87)	275 (10.83)	160 (6.30)	150 (5.91)	22 (49)						
	OFL-75-4A		260 (10.24)	210 (8.27)	290 (11.42)	85 (3.35)	170 (6.69)	155 (6.10)	233 (9.17)		M8	M10	25 (55)
	OFL-90-4A		230 (9.06)	330 (12.99)	190 (7.48)	170 (6.69)	28 (62)						
	OFL-110-4A		300 (11.81)	240 (9.45)	340 (13.39)	100 (3.94)	200 (7.87)	180 (7.09)	333 (13.11)		M10	M12	38 (84)
	OFL-132-4A		320 (12.60)	270 (10.63)	350 (13.78)	105 (4.13)	220 (8.66)	190 (7.48)					42 (93)
	OFL-160-4A		340 (13.39)	11.81 (300)	390 (15.35)	115 (4.53)	250 (9.84)	200 (7.87)	60 (132)		M10	M12	48 (106)
	OFL-200-4A		350 (13.78)	270 (10.63)	350 (13.78)	105 (4.13)	220 (8.66)	190 (7.48)					70 (154)
	OFL-220-4A		350 (13.78)	11.81 (300)	430 (16.93)	115 (4.53)	250 (9.84)	200 (7.87)	78 (172)		M10	M12	70 (154)
	OFL-280-4A		350 (13.78)	11.81 (300)	430 (16.93)	115 (4.53)	250 (9.84)	200 (7.87)					78 (172)
	OFL-315-4A	E/G	440 (17.32)	275 (10.83)	450 (17.72)	150 (5.91)	230 (9.06)	170 (6.69)	-	-	M12	M12	90 (198)
	OFL-355-4A			290 (11.42)	480 (18.90)		245 (9.65)	175 (6.89)					100 (221)
	OFL-400-4A			295 (11.61)	510 (20.08)		240 (9.45)	110 (243)					
	OFL-450-4A			325 (12.80)	470 (18.50)		270 (10.63)	195 (7.68)					125 (276)
OFL-500-4A	335 (13.19)			500 (19.69)	280 (11.02)		210 (8.27)	145 (320)					
OFL-630-4A	480 (18.90)			355 (13.98)	560 (22.05)		245 (9.65)	170 (375)					

4.4.1.6 Zero-phase reactors for reducing radio noise (ACLs)

An ACL is used to reduce radio frequency noise emitted from the inverter output lines. Pass the total of four wires--three inverter output wires and a grounding wire through the ACL in the same passing direction four times. If shielded wires are used, pass them through the ACL with their shields four times. Be sure to use wires with a heat resistance of 75°C (167°F) or above.

The ACL absorbs high-frequency noise components and emits them as heat into the air so that the amount of heat generation can be large. If it happens, lower the carrier frequency, upgrade the heat-resistance rank of wires, increase the number of the ACLs to decrease the number of turns per ACL, replace the ACLs with higher type ones, or take any other measures.

The wire size is determined depending upon the ACL size (I.D.) and installation requirements. Refer to Table 6.13.

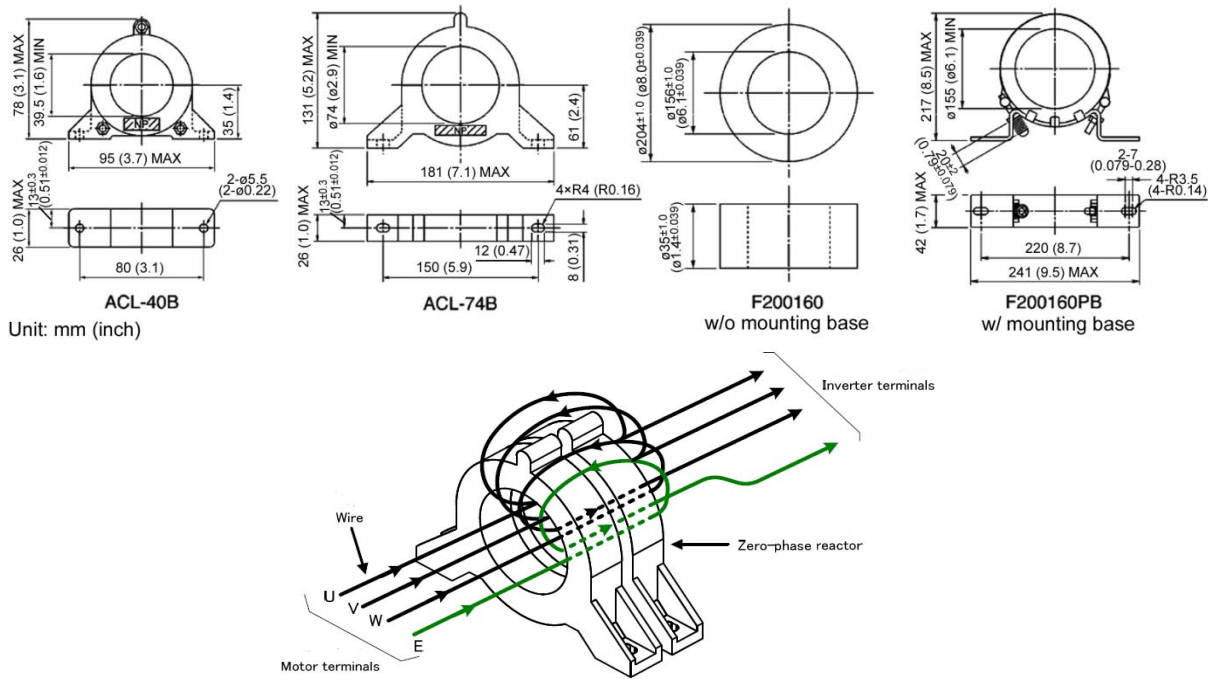

Figure 4.4-1 Dimensions of Zero-phase Reactor for Reducing Radio Noise (ACL) and Connection Example

Table 6.13 Wire size selection (ACL)

ACL type	Installation requirements		Wire size (mm ²)	Wire size (AWG)
	Q'ty	Number of turns		
ACL-40B	1	4	5.5 or below	10 or below
	2	2	14 or below	6 or below
	4	1	38 or below	1 or below
ACL-74B	1	4	14 or below	6 or below
	2	2	60 or below	1/0 or below
	4	1	250 or below	500 or below

Note: Use wires for the maximum allowable temperature of 75°C (167°F).

4.4.2 Selecting options for operation and communication

4.4.2.1 External frequency command potentiometer

An external frequency command potentiometer may be used to set the drive frequency. Connect the potentiometer to control signal terminals [11] through [13] of the inverter as shown in Figure 4.9.

Model: RJ-13 (BA-2 B-characteristics, 1 k Ω)

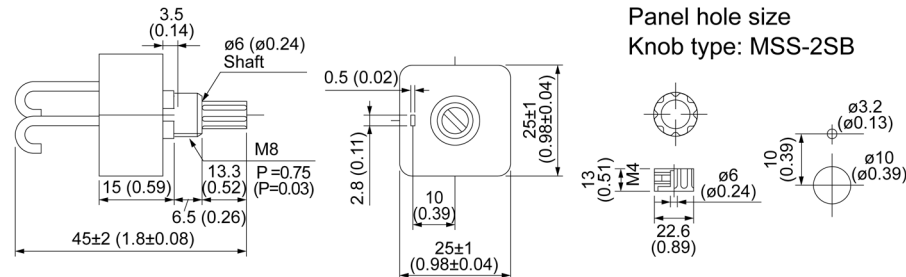

Dial plate type: YS549810-0

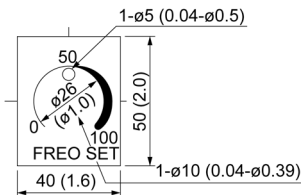

Unit: mm (inch)

Note: The dial plate and knob must be ordered as separated items.
Available from Fuji Electric Technica Co., Ltd.

Model: WAR3W (3W B-characteristics, 1 k Ω)

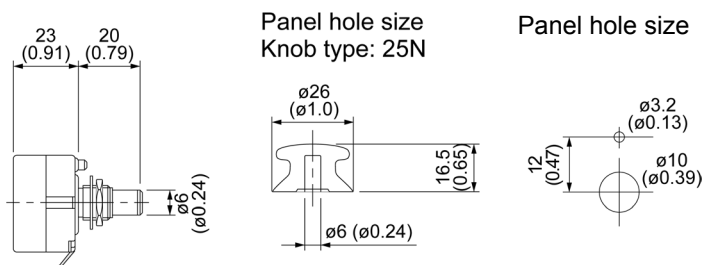

Dial plate type: 40P

Unit: mm (inch)

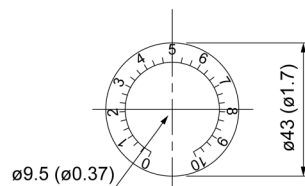

Note: The dial plate and knob must be ordered as separated items.
Available from Fuji Electric Technica Co., Ltd.

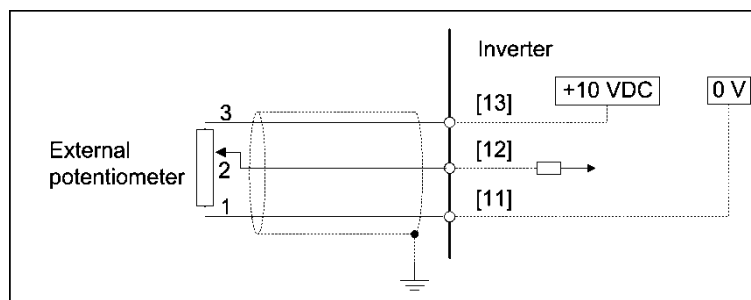

Figure 4.9 Dimensions of External Frequency Command Potentiometer and Connection Example

4.4.2.2 Extension cable for remote operation

The extension cable connects the inverter with the keypad (standard or multi-function) or USB-RS-485 converter to enable remote operation of the inverter. The cable is a straight type with RJ-45 jacks and its length is selectable from 5, 3, and 1 m (16, 9.8, and 3.3 ft).

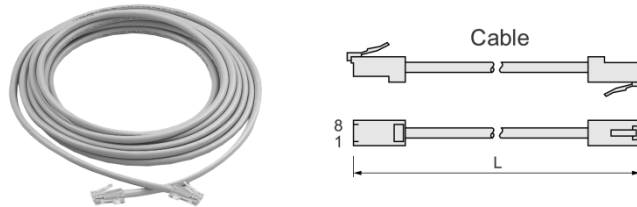

Table 4.12 Extension Cable Length for Remote Operation

Type	Length ft
CB-5S	5m (16 ft)
CB-3S	3m (9.8 ft)
CB-1S	1m (3.3 ft)

4.4.2.3 Frequency meters

Connect a frequency meter to analog signal output terminals [FM1] or [FM2] and [11] of the inverter to measure the frequency component selected by function code F31. Figure 4.10 shows the dimensions of the frequency meters and the connection example.

Model: TRM-45 (10 VDC, 1 mA)

This model has two types of calibration: "0 to 60/120 Hz" and "60/120/240 Hz."

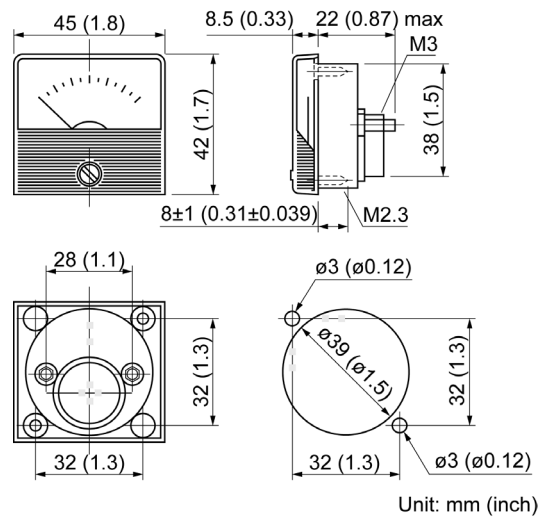

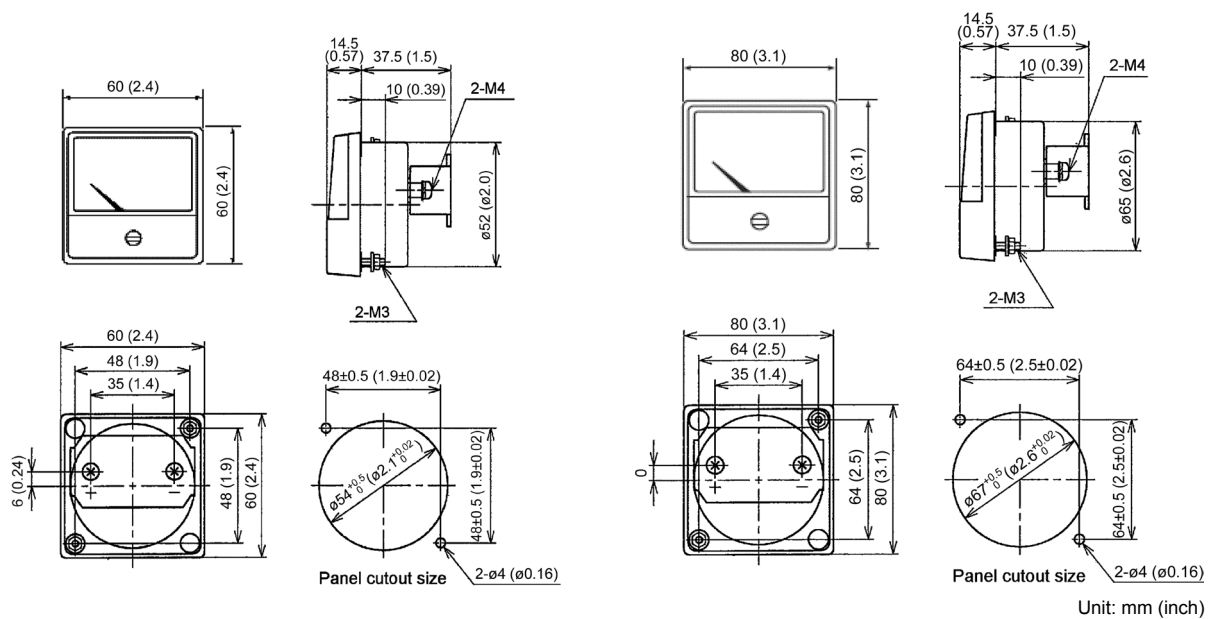
Model: FMN-60 (10 VDC, 1 mA)**Model: FMN-80 (10 VDC, 1 mA)**

Available from Fuji Electric Technica Co., Ltd.

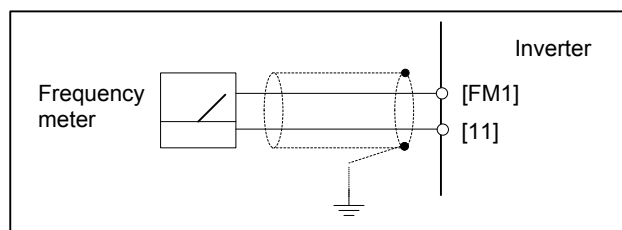

Figure 4.10 Frequency Meter Dimensions and Connection Example

4.4.2.4 Inverter support loader software

FRENIC Loader is support software which enables the inverter to be operated via the RS-485 communications facility. The main functions include the following:

- Easy editing of function code data
- Monitoring the operation statuses of the inverter such as I/O monitor and multi-monitor
- Operation of inverters on a PC screen (Windows-based only)

 Refer to Chapter 8 "RUNNING THROUGH RS-485 COMMUNICATION" for details.

4.4.3 Selecting Option Cards

4.4.3.1 List of option cards, connection ports, and applicable ROM versions

The table below lists the option cards, option connection ports, and applicable ROM versions.

(Function enhancement or version update in the future may provide new options. For options not listed below, contact Fuji Electric or visit our website.)

Option type	Model name	Option connection ports			ROM version	Remarks
		A-port	B-port	C-port		
Relay output	OPC-RY	√	√	--	1100 or later	Two option cards connectable at a time to A- and B-ports (4 outputs).
	OPC-RY2	--	√	√	1100 or later	A single option card connectable to B- and C-ports (both ports occupied)
I/O	OPC-AIO	√	√	√	1300 or later	A single option card connectable at a time to any one of A-, B- and C-ports.
	OPC-AO	√	√	√	1100 or later	A single option card connectable at a time to any one of A-, B- and C-ports.
	OPC-PT	√	√	√	1300 or later	A single option card connectable at a time to any one of A-, B- and C-ports.
Communication	OPC-DEV	√	√	√	1100 or later	Only one of these communications option cards connectable to the inverter at a time. (e.g. Connection of both OPC-DEV and OPC-CCL at a time is not possible.)
	OPC-COP	√	--	--	1100 or later	
	OPC-PDP2	√	--	--	1100 or later	
	OPC-CCL	√	--	--	1100 or later	
	OPC-LNW	√	--	--	1100 or later	
	OPC-ETH	√	--	--	1100 or later	



Note

- Two relay output interface cards OPC-RY can be mounted concurrently.
- The analog interface card OPC-AIO and analog current output interface card OPC-AO cannot be mounted concurrently.

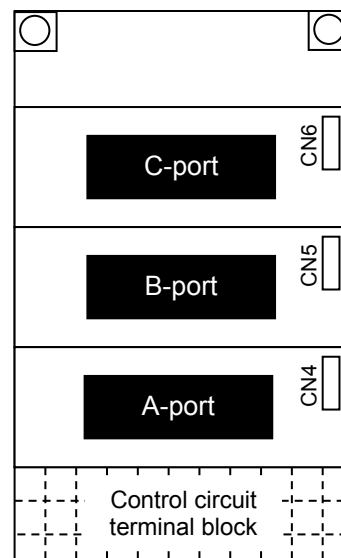

4.4.3.2 Relay output interface card (OPC-RY)

The relay output interface card OPC-RY converts general-purpose output signals issued via inverter terminals [Y1] and [Y2] or [Y3] and [Y4] to a relay output (one transfer contact). It has two independent transfer contacts so that using two cards allows the user to activate up to four contact outputs (Y1 to Y4).

A signal to be output to each contact can be defined with function codes E20 to E23. Selecting "Active OFF" for a contact output with the function code enables the contact to be turned ON without relay coil excitation. This is useful for a fail-safe application for the power system.

Ports available for the interface card and functionality assignments

A FRENIC-HVAC inverter has three option connection ports. Note that each port has some limitations as shown below.

Option connection port	Output signal	Assignment	Notes
A-port	Relay contact output 1 Relay contact output 2	Function code E20 (Y1) Function code E21 (Y2)	Do not connect this card to the inverter's terminal [Y1] or [Y2].
B-port	Relay contact output 1 Relay contact output 2	Function code E22 (Y3) Function code E23 (Y4)	Do not connect this card to the inverter's terminal [Y3] or [Y4].
C-port	Not available for the relay output interface card		

Terminal functions

Symbol	Name	Descriptions
[1A] [1B] [1C]	Relay contact output 1	Relay contacts to output signals selected by function codes E20 and E22, such as Inverter Running, Frequency Arrival and Overload Early Warning. In "active ON", the contact [1A] – [1C] closes and [1B] – [1C] opens while the signal is active.
[2A] [2B] [2C]	Relay contact output 2	Relay contacts to output signals selected by function codes E21 and E23, such as Inverter Running, Frequency Arrival and Overload Early Warning. In "active ON", the contact [1A] – [1C] closes and [1B] – [1C] opens while the signal is active.

Electrical requirements

Item	Specifications
Contact capacity	250 VAC, 0.3A, $\cos\Phi = 0.3$, or 48 VDC, 0.5A (resistor load)
Contact life	200,000 times (ON/OFF every 1 second) at 250 VAC, 0.3A 200,000 times (ON/OFF every 1 second) at 48 VDC, 0.5A Note: When frequent ON/OFF switching is anticipated (for example, when using the current limit function with the inverter output limiting signal), use the terminals [Y1] to [Y4] (transistor outputs) instead.
Safety Standards/Directives	EN61800-5-1, Overvoltage Category II (Reinforced Insulation) 250 VAC class

Internal circuits

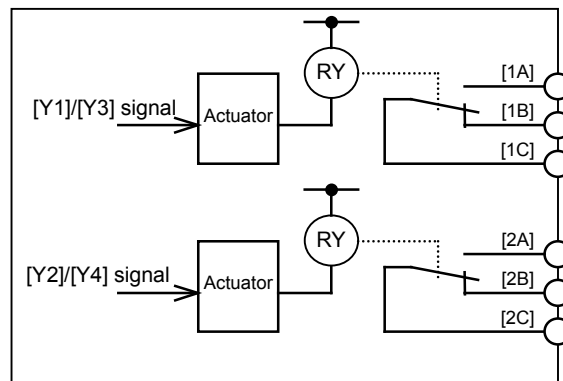

Figure 4.11 Internal Circuits

The relationship between function codes and relay output functions is as follows.

Function code	Functions	Setting range
E20	Terminal [Y1] (Function selection)	0 to 235 (For normal logic), or 1000 to 1235 (For negative logic)
E21	Terminal [Y2] (Function selection)	
E22	Terminal [Y3] (Function selection)	
E23	Terminal [Y4] (Function selection)	

E20 through E23 assign output signals to general-purpose, programmable output terminals [Y1], [Y2], [Y3], and [Y4]. These function codes can also switch the logic system between normal and negative to define the property of those output terminals so that the inverter logic can interpret either the ON or OFF status of each terminal as active.

When a negative logic is employed, all output signals are active (e.g. an alarm would be recognized) while the inverter is powered OFF. To avoid causing system malfunctions by this, interlock these signals to keep them ON using an external power ON signal. Furthermore, the validity of these output signals is not guaranteed for approximately 1.5 seconds after power ON, so introduce such a mechanism that masks them during the transient period.

4.4.3.3 Relay output interface card (OPC-RY2)

The relay output interface card OPC-RY2 adds seven independent transfer contacts (1A contact) to the inverter. Using this card under cascade control enables the inverter to control seven motors. (Using also two transfer contacts on the inverter unit makes it possible to control a maximum of eight motors plus one (auxiliary pump) under cascade control.)

Ports available for the interface card

This interface card can be connected to either one of the B- and C-ports, out of three option connection ports (A-, B-, and C-ports) provided on the FRENIC-HVAC. Two or more relay output interface cards cannot be connected at a time.

Terminal functions

Symbol	Name	Descriptions
[6A/6C]	Relay contact output 6	These relay contacts output various signals ("Inverter running," "Frequency arrival signal," "Motor overload early warning," etc.) selected with Function codes o01 to o07. When [nA-nC] is short-circuited (active ON), the output signal is Active. Where, n = one of 6 to 12.
[7A/7C]	Relay contact output 7	
[8A/8C]	Relay contact output 8	
[9A/9C]	Relay contact output 9	
[10A/10C]	Relay contact output 10	
[11A/11C]	Relay contact output 11	
[12A/12C]	Relay contact output 12	

Electrical requirements

Item	Specifications
Contact capacity	250 VAC, 0.3A, $\cos\Phi = 0.3$, or 48 VDC, 0.5A (resistor load)
Contact life	200,000 times (ON/OFF every 1 second) at 250 VAC, 0.3A 200,000 times (ON/OFF every 1 second) at 48 VDC, 0.5A Note: When frequent ON/OFF switching is anticipated (for example, when using the current limit function with the inverter output limiting signal), use the terminals [Y1] to [Y4] (transistor outputs) instead.
Safety Standards/Directives	EN61800-5-1, Overvoltage Category II (Reinforced Insulation) 250 VAC class

Internal circuits

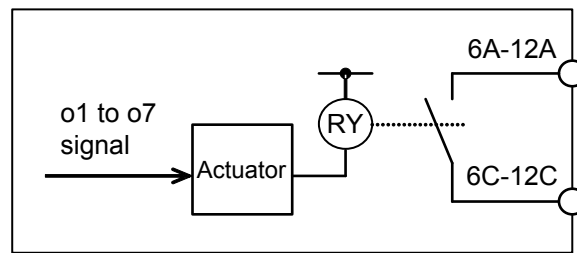

Figure 4.12 Internal Circuits

The relationship between function codes and relay output functions is as follows.

Function code	Functions	Setting range
o01	Relay contact output 6 (Function selection)	0 to 235, 1000 to 1235 (For negative logic)
o02	Relay contact output 7 (Function selection)	
o03	Relay contact output 8 (Function selection)	
o04	Relay contact output 9 (Function selection)	
o05	Relay contact output 10 (Function selection)	
o06	Relay contact output 11 (Function selection)	
o07	Relay contact output 12 (Function selection)	

o01 through o07 assign output signals to general-purpose, programmable relay outputs 6 through 12. These function codes can also switch the logic system between normal and negative to define the property of those relay outputs so that the inverter logic can interpret either the ON or OFF status of each relay output as active.

When a negative logic is employed, all output signals are active (e.g., an alarm would be recognized) while the inverter is powered OFF. To avoid causing system malfunctions by this, interlock these signals to keep them ON using an external power ON signal. Furthermore, the validity of these output signals is not guaranteed for approximately 2 seconds after power ON, so introduce such a mechanism that masks them during the transient period.

4.4.3.4 Analog interface card (OPC-AIO)

The analog interface card has the terminals listed below. Mounting this interface card on the FRENIC-HVAC enables analog input and analog output to/from the inverter.

- One analog voltage input point (0 to ± 10 V)
- One analog current input point (4 to 20 mA or 0 to 20 mA, switchable)
- One analog voltage output point (0 to ± 10 V)
- One analog current output point (4 to 20 mA)

Ports available for the interface card

This interface card can be connected to any one of the three option connection ports (A-, B-, and C-ports) on the FRENIC-HVAC.

Terminal functions

Classifications	Symbol	Name	Functions	Remarks
Analog input	[P10]	Power supply for the potentiometer	Power supply for frequency command potentiometer (Variable resistor: 1 to 5 k Ω) (10 VDC, 10 mA DC max.)	
	[32]	Analog voltage input	<ul style="list-style-type: none"> - Used as analog voltage input from external equipment. 0 to ± 10 VDC/0 to $\pm 100\%$ (0 to ± 5 VDC/0 to $\pm 100\%$) - Signal assignment: Selectable from signals that can be assigned to inverter standard terminal [12]. - Resolution: 1/3000 	Input impedance: 22k Ω Max. input: ± 15 VDC
	[C2]	Analog current input	<ul style="list-style-type: none"> - Used as analog current input from external equipment. 4 to 20 mA DC/0 to 100% - Signal assignment: Selectable from signals that can be assigned to inverter standard terminal [12]. - Resolution: 1/3000 	Input impedance: 250 Ω Max. input: 30 mA DC
	[31]	Analog common	- Reference terminal for [P10], [32], [C2].	Equipotent with the inverter's terminal [11]

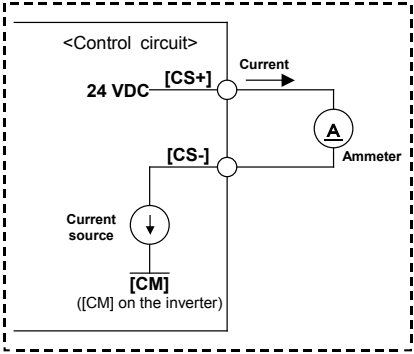
Classifications	Symbol	Name	Functions	Remarks
Analog output	[Ao+]	Analog voltage output (+)	<ul style="list-style-type: none"> - Outputs the monitor signal of analog DC voltage (0 to ±10 VDC). - Signal assignment: Selectable from signals that can be issued from inverter standard terminal [FM1]. This terminal can also output bipolar PID deviation. - Resolution: 1/3000 * Capable of driving up to two analog voltmeters with 10kΩ impedance. 	
	[Ao-]	Analog voltage output (-)	<ul style="list-style-type: none"> - Reference terminal for [Ao+]. 	Equipotent with the inverter's terminal [11]
	[CS+]	Analog current output (+)	<ul style="list-style-type: none"> - Outputs the monitor signal of analog DC current (4 to 20 mA DC). - Signal assignment: Selectable from signals that can be issued from inverter standard terminal [FM1]. - Resolution: 1/3000  <p>* Input impedance of the external device: Max. 500Ω</p>	Isolated from inverter's terminals [31], [Ao-], and [11]
	[CS-]	Analog current output (-)		

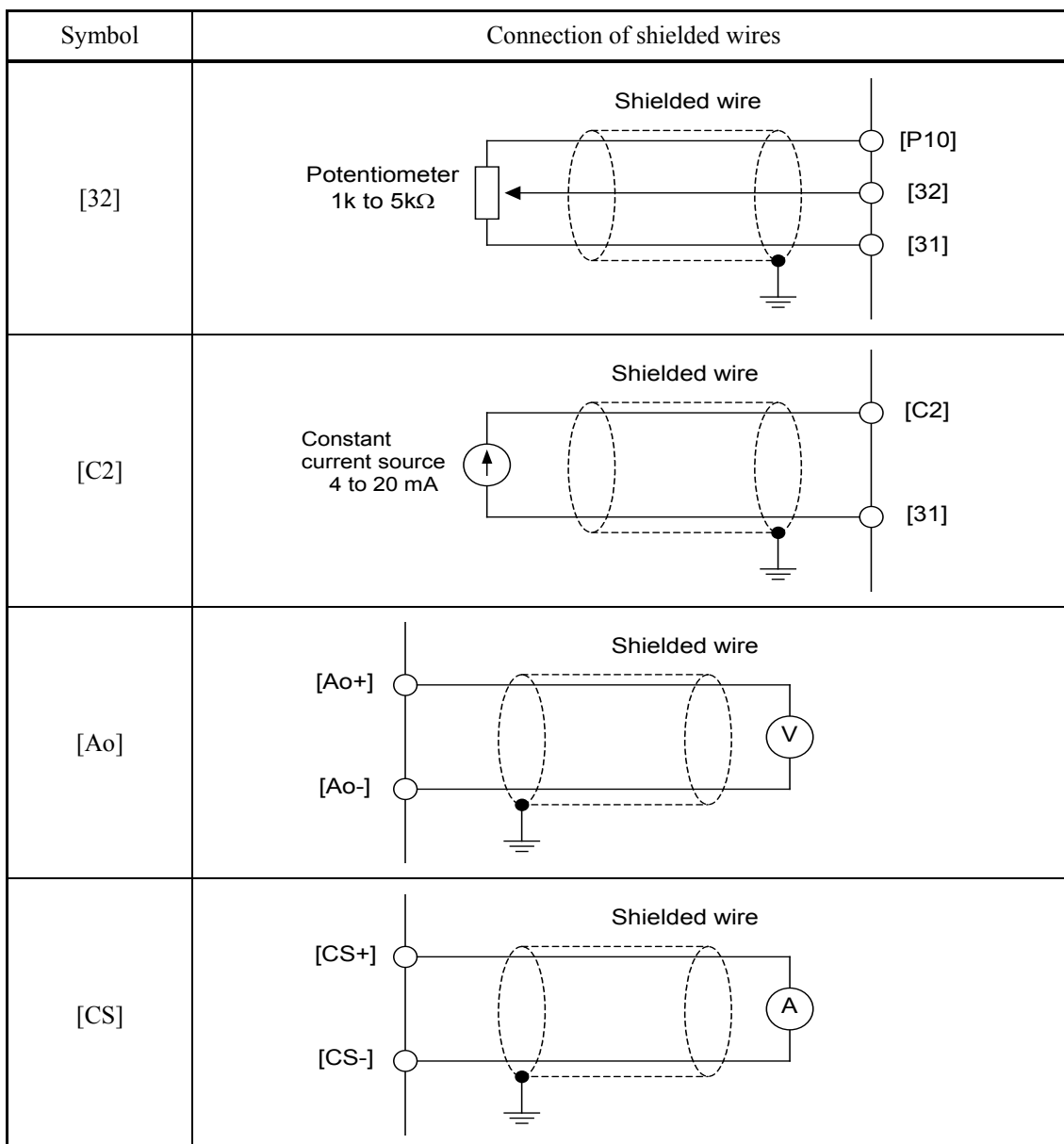
Connection example**Function code settings**

Function Codes and Their Data for Terminals [32] and [C2]

Function code	Name	Data	Description	Remarks
o60	Terminal [32] Function (Mode selection)	0 to 49	Same as E61.	
o61	(Offset adjustment)	-5.0 to +5.0%	Offset adjustment amount	
o62	(Gain adjustment)	0.00 to 200.00%	Gain adjustment amount	
o63	(Filter setting)	0.00 to 5.00 s	Filter constant	
o64	(Gain base point)	0.00 to 100.00%	Gain base point	
o65	(Polarity)	0	Bipolar	
		1	Unipolar	
o66	(Bias)	-100.00 to 100.00	Bias value	

Function Codes and Their Data for Terminals [32] and [C2] (Continued)

Function code	Name	Data	Description	Remarks
o67	(Bias base point)	0.00 to 100.00%	Bias base point	
o69	(Display unit)	1 to 48	Same as J105.	
o70	(Maximum scale)	-999 to 0.00 to 9990	Maximum scale	
o71	(Minimum scale)	-999 to 0.00 to 9990	Minimum scale	
o75	Terminal [C2] Function (Current range selection)	0	4 to 20 mA	
		1	0 to 20 mA	
o76	(Mode selection)	0 to 49	Same as E61.	
o77	(Offset adjustment)	-5.0 to +5.0%	Offset adjustment amount	
o78	(Gain adjustment)	0.00 to 200.00%	Gain adjustment amount	
o79	(Filter setting)	0.00 to 5.00 s	Filter constant	
o81	(Gain base point)	0.00 to 100.00%	Gain base point	
o82	(Bias)	-100.00 to 100.00	Bias value	
o83	(Gain base point)	0.00 to 100.00%	Gain base point	
o85	(Display unit)	1 to 48	Same as J105.	
o86	(Maximum scale)	-999 to 0.00 to 9990	Maximum scale	
o87	(Minimum scale)	-999 to 0.00 to 9990	Minimum scale	

Function Codes and Their Data for Terminal [Ao]

Function code	Name	Data	Description	Remarks
o90	Terminal [Ao] Function (Mode selection)	0 to 117	Same as F31.	
o91	(Gain adjustment)	0 to 300%	Gain adjustment amount	
o93	(Polarity)	0	Bipolar	
		1	Unipolar	

Function Codes and Their Data for Terminal [CS]

Function code	Name	Data	Description	Remarks
o96	Terminal [CS] Function (Mode selection)	0 to 117	Same as F31.	
o97	(Gain adjustment)	0 to 300%	Gain adjustment amount	

4.4.3.5 Analog current output (2 ch) interface card (OPC-AO)

The analog current output interface card has the terminals listed below. Mounting this interface card on the FRENIC-HVAC enables 2 channels of analog output from the inverter.

- Two analog current output points (4 to 20 mA)

Note The analog interface card OPC-AIO and analog current output interface card OPC-AO cannot be mounted concurrently.

Ports available for the interface card

This interface card can be connected to any one of the three option connection ports (A-, B-, and C-ports) on the FRENIC-HVAC.

Terminal functions

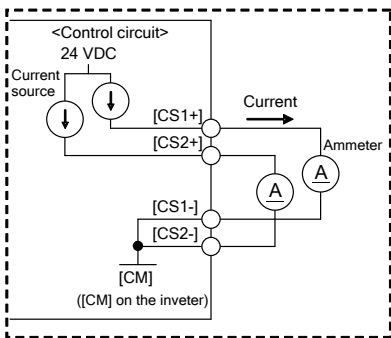
Classifications	Symbol	Name	Functions	Remarks
Analog current output	[CS1+] [CS2+]	Analog current output (+)	<ul style="list-style-type: none"> - Outputs the monitor signal of analog DC current (4 to 20 mA DC). - Signal assignment for each of CS1 and CS2: Selectable from signals that can be issued from inverter standard terminals [FM1] and [FM2]. - Resolution: 1/3000 - Output current error: Max. ±3% - Maximum allowable input impedance of connected devices: Max. 500Ω 	Isolated from inverter's terminal [11]
	[CS1-] [CS2-]	Analog current output (-)		

Connection example

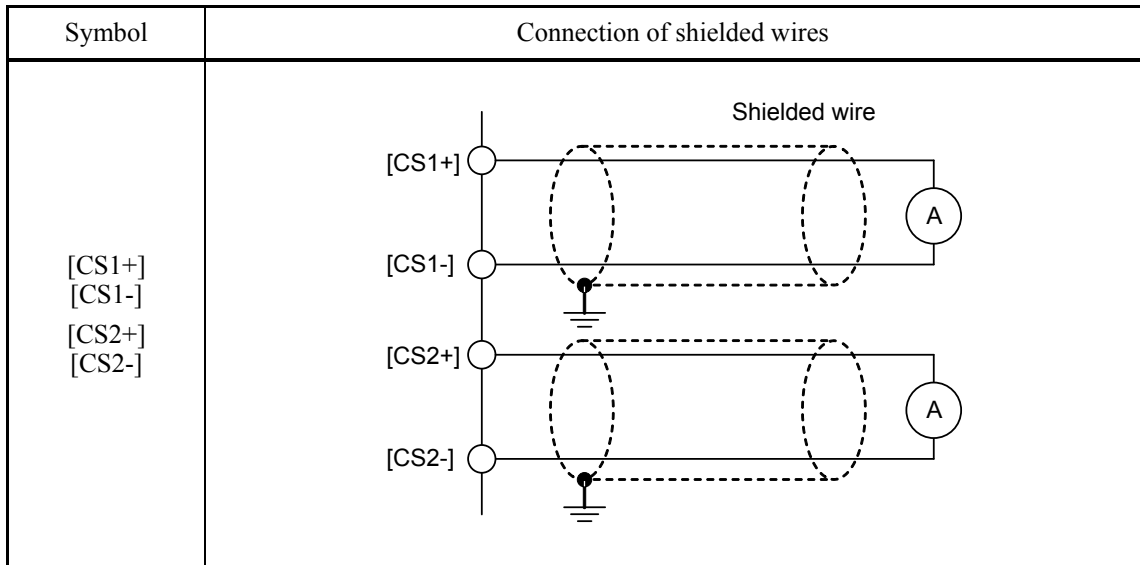

Function code settings

Function Codes and Their Data for Terminal [CS1]

Function code	Name	Data	Description	Remarks
o96	Terminal [CS1] function (Mode selection)	0 to 117	Same as F31.	
o97	(Gain adjustment)	0 to 300%	Gain adjustment amount	

Function Codes and Their Data for Terminal [CS2]

Function code	Name	Data	Description	Remarks
o90	Terminal [CS2] function (Mode selection)	0 to 117	Same as F31.	
o91	(Gain adjustment)	0 to 300%	Gain adjustment amount	

4.4.3.6 Resistance temperature detector input card (OPC-PT)

The resistance temperature detector input card connects a resistance temperature detector (RTD) to the FRENIC-HVAC to convert the temperature values to the digital ones. It can connect two RTDs. The following five types of RTDs are connectable: "JPt100," "Pt100," "Ni100," "Pt1000" and "Ni1000."

Ports available for the card

The input card can be connected to any one of the three connection ports (A-, B- and C-ports) on the inverter.

Specifications

Items	Specifications	
Number of input channels	2	
Applicable RTD type	JPt100, Pt100, Ni100, Pt1000, Ni1000 / Three-wire *The RTD type can be specified by the function code.	
RTD excited current	JPt100, Pt100, Ni100: 1 mA Pt1000, Ni1000: 0.5 mA *Switchable by slide switches.	
Temperature range	-20 to +100°C (-4 to 212°F, 253 to 373 K)	
Resolution	0.01°C (0.01°F, 0.01 K)	
Accuracy	±0.3% FS (at the inverter ambient temperature of 23°C (73.4°F, 296 K).) ±0.7% FS (All ranges of inverter ambient temperature) *Not including an RTD error.	
Sampling interval	Max. 700 ms / two channels	
Input filter time *1	Hardware (time constant): 50 ms or less Digital filter time: 0.0 to 100.0 s (Can be set in units of 0.1 s (default: 1.0 s).)	
Insulation	Between sensor input terminal and internal logic:	Photocoupler insulation
	Between sensor input terminal and CM/11/CMY:	Transformer insulation
	Between sensor input terminals:	None
Failure detection	Sensor wire break and short circuit, Incorrect configuration of switches *2	

*1 The input filter time does not affect display values.

*2 The setting of "Pt channel sensor type (o10, o15)" should be identical with the applied sensor. Wiring across channels should not be made; doing so may inhibit failure detection. If a failure is detected, the "-30°C (-22°F)" appears.

Terminal functions

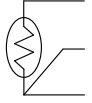
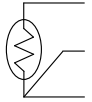
Symbols		Terminal name	Specifications
	A1	RTD input terminal Channel 1	RTD connection terminal for channel 1.
	b1		
	B1		
	A2	RTD input terminal Channel 2	RTD connection terminal for channel 2.
	b2		
	B2		



Function code setting

Function code	Name	Data	Contents	Remarks
o09	Display unit	60	Kelvin (K)	Factory default: 61
		61	Celsius (°C)	
		62	Fahrenheit (°F)	
o10	Channel 1 (Sensor type)	0	JPt100: JIS C 1604	Factory default: 0
		1	Pt100: JIS C 1604 / IEC 60751	
		2	Ni100: DIN 43760	
		3	Pt1000: IEC 60751	
		4	Ni1000: DIN 43760	
o11	(Extended functions)	0	No extended function assigned	Factory default: 0
		5	PID feedback value 1	
		30	PID feedback value 2	
		42	External PID feedback value 1	
		45	External PID feedback value 2	
		48	External PID feedback value 3	
o12	(Digital filter)	0.0 to 100.0 s	Filter time	Factory default: 1.0 s
o15	Channel 2 (Sensor type)	0 to 4	Same as o10.	Factory default: 0
o16	(Extended functions)	0 to 48	Same as o11.	Factory default: 0
o17	(Digital filter)	0.0 to 100.0 s	Same as o12.	Factory default: 1.0 s

Configuring the switches

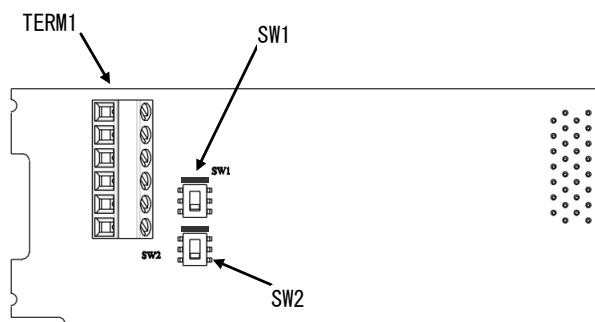
Switching the slide switches located on the input card is needed to match the sensor connected.



	Sensor type	Switch setting	Default setting
SW1: Channel 1 SW2: Channel 2	JPt100		
	Pt100		
	Ni100		
	Pt1000		
	Ni1000		

Display of detected temperature

The detected temperature (after digital filtering) is displayed on the I/O monitor of the keypad.

PRG>3>3[7/7]	
Ai:OPC-PT	
Ch1	+0.00°C
Ch2	+0.00°C

4.4.3.7 CC-Link communications card (OPC-CCL)



This communications card may not apply to the inverter depending upon the inverter ROM version. Consult your Fuji Electric representative.

CC-Link (Control & Communication Link) is an FA open field network system.

The CC-Link communications card connects the inverter to a CC-Link master via CC-Link using a dedicated cable. It supports the transmission speed of 156 kbps to 10 Mbps and the total length of 100 to 1,200 m (328 to 3900 ft) so that it can be used in wide range of systems requiring a high-speed or long-distance transmission, enabling a flexible system configuration.

Ports available for the communications card

This communications card can be connected to the A-port only, out of three option connection ports (A-, B-, and C-ports) provided on the FRENIC-HVAC.

Note: Once the inverter is equipped with this communications card, no more communications card (e.g., DeviceNet and SX-bus communications cards) is allowed on the inverter. Mounting more than one card on the inverter causes the Er4 trip that cannot be reset until those cards are removed except a single card.

CC-Link specifications

Item	Specifications				
Applicable controller	Mitsubishi Electric sequencer, etc. (CC-Link master)				
Transmission system	CC-Link version 1.10 and 2.0 (Broadcast polling system)				
Number of inverters connectable	Max. 42 units (one station occupied/unit)				
Number of stations occupied	CC-Link version 1.10: 1 station occupied CC-Link version 2.0: 1 station occupied (Selectable from among 2X, 4X and 8X settings)				
Transmission speed (Baud rate)	10, 5, 2.5 Mbps 625, 156 kbps				
Maximum cable length (When using the CC-Link dedicated cable)	10 Mbps	5 Mbps	2.5 Mbps	625 kbps	156 kbps
	100 m (328 ft)	150 m (492 ft)	200 m (656 ft)	600 m (2000 ft)	1200 m (3900 ft)
Insulation	500 VDC (photocoupler insulation)				
Station type	Remote device station				
Remote device type	Inverter (0x20)				

For items not contained in the above table, the CC-Link specifications apply.

Inverter's function codes dedicated to CC-Link communication

Function code	Function	Data setting range *1	Description															
y98	Select run/frequency command sources	<u>0</u> to 3	Select from the following choices: <table border="1" data-bbox="885 338 1370 562"> <thead> <tr> <th>y98</th> <th>Frequency command source</th> <th>Run command source</th> </tr> </thead> <tbody> <tr> <td>0</td> <td>Inverter</td> <td>Inverter</td> </tr> <tr> <td>1</td> <td>CC-Link</td> <td>Inverter</td> </tr> <tr> <td>2</td> <td>Inverter</td> <td>CC-Link</td> </tr> <tr> <td>3</td> <td>CC-Link</td> <td>CC-Link</td> </tr> </tbody> </table>	y98	Frequency command source	Run command source	0	Inverter	Inverter	1	CC-Link	Inverter	2	Inverter	CC-Link	3	CC-Link	CC-Link
y98	Frequency command source	Run command source																
0	Inverter	Inverter																
1	CC-Link	Inverter																
2	Inverter	CC-Link																
3	CC-Link	CC-Link																
o27	Select error processing for CC-Link network breaks	<u>0</u> , 4 to 9	Immediately coast to a stop and trip with Er5.															
		1	After the time specified by o28, coast to a stop and trip with Er5.															
		2	If the communications link is restored within the time specified by o28, ignore the communications error. If a timeout occurs, coast to a stop and trip with Er5.															
		3, 13 to 15	Keep the current operation, ignoring the communications error. (No Er5 trip occurs.)															
		10	Immediately decelerate to a stop. Issue Er5 after stopping.															
		11	After the time specified by o28, decelerate to a stop. Issue Er5 after stop.															
		12	If the communications link is restored within the time specified by o28, ignore the communications error. If a timeout occurs, decelerate to a stop and trip with Er5.															
o28	Set the operation timer to be used in error processing for network breaks	<u>0.0</u> to 60.0 sec.	Applies when o27 = 1, 2, 11, or 12															
o30	CC-Link extension	5 to 255	No operation															
		<u>0</u> , 1	1 station occupied (CC-Link version 1.10)															
		2	1 station occupied, 2X setting (CC-Link version 2.00)															
		3	1 station occupied, 4X setting (CC-Link version 2.00)															
		4	1 station occupied, 8X setting (CC-Link version 2.00)															
o31	Station address *2	<u>0</u> , 1 to 64	Any of 1 to 64 should be specified for a slave station. Specifying any other value causes the L.ERR LED to light.															
o32	Transmission speed *2	<u>0</u> to 4	0: 156 kbps, 1: 625 kbps, 2: 2.5 Mbps, 3: 5 Mbps, 4: 10 Mbps Specifying any other value causes the L.ERR LED to light.															

*1 The underlined values are factory defaults.

*2 If the station address (o31) or the transmission speed (o32) is modified when the inverter power is ON, the L.ERR LED flashes and the communications link is lost. Turning the terminal command **RST** ON or restarting both the inverter and the communications card validates the new setting.

4.4.3.8 PROFIBUS-DP communications card (OPC-PDP2)



This communications card may not apply to the inverter depending upon the inverter ROM version. Consult your Fuji Electric representative.

The PROFIBUS-DP communications card is used to connect the FRENIC-HVAC series to a PROFIBUS-DP master via PROFIBUS. Mounting the communications card on the FRENIC-HVAC enables the user to control the FRENIC-HVAC as a slave unit by configuring and monitoring run and frequency commands and accessing inverter's function codes from the PROFIBUS master.

The communications card has the following features:

- PROFIBUS version : DP-V0 compliant
- Transmission speed : 9,600 bps to 12 Mbps
- Applicable profile : PROFIDrive V2
- Able to read and write all function codes supported in the FRENIC-HVAC

Ports available for the communications card

This communications card can be connected to the A-port only, out of three option connection ports (A-, B-, and C-ports) provided on the FRENIC-HVAC.

Note: Once the inverter is equipped with this communications card, no more communications card (e.g., DeviceNet and SX-bus communications cards) is allowed on the inverter. Mounting more than one card on the inverter causes the Er4 trip that cannot be reset until those cards are removed except a single card.

PROFIBUS-DP specifications

Item		Specifications	Remarks
Transmission section	Lines	RS-485 (insulated cable)	
	Cable length	See the table below.	
	Transmission speed	9.6, 19.2, 45.45, 93.75, 187.5, 500 kbps 1.5, 3, 6, 12 Mbps (auto configuration)	To be specified in the master node
	Protocol	PROFIBUS-DP (DP-V0)	IEC 61158 and 61784
Connector		Pluggable, six-pin terminal block	Manufactured by Phoenix Contact Inc.
Control section	Controller	SPC3 (Siemens)	
	Comm. buffer	1472 bytes (SPC3 built-in memory)	
Addressing		- By on-board node address switches (rotary switches) (0 to 99) or - By inverter's function code o31 (data = 0 to 125)	Setting both node address switches SW1 and SW2 to "0" enables the o31 setting.
Diagnostics	Detection of cable break		Indicated by the OFFL LED
	Detection of the illegal configuration		Indicated by the ERR LED

The maximum cable length per segment for a PROFIBUS-DP specified cable is listed below.

Transmission speed (bps)	Maximum cable length per segment
9.6 k	1200 m (4000 ft)
19.2 k	1200 m (4000 ft)
45.45 k	1200 m (4000 ft)
93.75 k	1000 m (3300 ft)
187.5 k	1000 m (3300 ft)
500 k	400 m (1300 ft)
1.5 M	200 m (650 ft)
3 M	100 m (330 ft)
6 M	100 m (330 ft)
12 M	100 m (330 ft)

Inverter's function codes dedicated to PROFIBUS-DP communication

The inverter's function codes listed in Table 4.13 should be configured for specifying run and frequency commands via PROFIBUS.

Table 4.13 Inverter's Function Codes Required for Enabling Run and Frequency Commands via PROFIBUS

Function code	Description	Factory default	Function code data to be set	Remarks															
y98	Select run/frequency command sources	0	3	Select from the following choices: <table border="1" data-bbox="928 495 1386 689"> <thead> <tr> <th>y98</th> <th>Frequency command source</th> <th>Run command source</th> </tr> </thead> <tbody> <tr> <td>0</td> <td>Inverter</td> <td>Inverter</td> </tr> <tr> <td>1</td> <td>PROFIBUS</td> <td>Inverter</td> </tr> <tr> <td>2</td> <td>Inverter</td> <td>PROFIBUS</td> </tr> <tr> <td>3</td> <td>PROFIBUS</td> <td>PROFIBUS</td> </tr> </tbody> </table>	y98	Frequency command source	Run command source	0	Inverter	Inverter	1	PROFIBUS	Inverter	2	Inverter	PROFIBUS	3	PROFIBUS	PROFIBUS
y98	Frequency command source	Run command source																	
0	Inverter	Inverter																	
1	PROFIBUS	Inverter																	
2	Inverter	PROFIBUS																	
3	PROFIBUS	PROFIBUS																	
y99	Loader Link Function (Run/frequency commands from Loader)	0	0	No change is required from the factory default.															
E01 or above	Terminal Xn Function (n: Terminal number)	--	Any data except "24 (1024), LE " (For all terminals Xn)	Even if LE is selected, LE = ON makes parameter y98 valid, but LE = OFF makes y98 invalid and run/frequency commands in the inverter are valid.															

Table 4.14 lists the other related inverter's function codes.

Table 4.14 Related Inverter's Function Codes

Function code	Description	Factory default	Data setting range	Remarks
o27	Select error processing for PROFIBUS network breaks	0	0 to 15	
o28	Set the operation timer to be used in error processing for network breaks	0.0 s	0.0 to 60.0 s	
o30	Select PPO type	0	0 to 255	For details about o30, refer to the instruction manual of this communications card.
o31	Select PROFIBUS station address	0	0 to 125	Valid when rotary switches SW1 and SW2 are set to "00."
o40 to o43	Assign function code data to be written, 1 to 4	0000	0x0000 to 0xFFFF	Configure function codes for writing to the data mapped I/O. Functionally equivalent to PNU915.
o48 to o51	Assign function code data to be read, 1 to 4	0000	0x0000 to 0xFFFF	Configure function codes for reading from the data mapped I/O. Functionally equivalent to PNU916.

Node address

(1) Configuring node address switches (SW1 and SW2)

Before the inverter power is turned ON, the node address of the communications card should be specified with SW1 and SW2 (rotary switches) on the card. The setting range is from 00 to 99 in decimal. SW1 specifies a 10s digit of the node address and the SW2, a 1s digit.

$$\text{Node address} = (\text{SW1 setting} \times 10) + (\text{SW2 setting} \times 1)$$

Note: The node address switches should be accessed with the inverter being OFF. Setting these switches with the inverter being ON requires restarting the inverter to enable the new settings.

Note: To specify a node address exceeding 99, use the function code o31 as described in (2) below.

(2) Configuring the o31 data

The node address can also be specified with the inverter's function code o31. The setting range is from 0 to 125.

With both SW1 and SW2 being OFF, restarting the inverter validates the setting made with the function code 31. If those switches are set to any value other than 00, the setting made with those switches remains valid.

Setting the o31 data to 126 or greater flashes the ERR LED on the communications card, telling an occurrence of a data setting error.

Selecting the PPO type

This communications card supports PPO types 1 through 4. For details about the PPO, refer to the instruction manual of the PROFIBUS-DP communications card.

The same PPO type should be specified at both the inverter keypad and the PROFIBUS master. If not, the communications card cannot start data exchange with the PROFIBUS master and flashes the ERR LED, telling an occurrence of a data setting error.

■ From the inverter keypad

The PPO type of the communications card can be specified with the inverter's function code o30 that is accessible from the inverter keypad after the communications card is mounted on the inverter.

After the setting of the PPO type is modified, the inverter should be restarted to validate the new setting.

o30	PPO type
0, 1, 6 to 255	PPO 1
2	PPO 2
3	PPO 3
4	PPO 4
5	PPO 2

■ From the PROFIBUS master

The PROFIBUS master sends the definition of the communications card in its configuration frame. The definition is stored in the GSD file. For the configuration procedure, refer to the PROFIBUS master's manual.

4.4.3.9 DeviceNet communications card (OPC-DEV)

The DeviceNet communications card is used to connect the FRENIC-HVAC series to a DeviceNet master via DeviceNet. Mounting the communications card on the FRENIC-HVAC enables the user to control the FRENIC-HVAC as a slave unit by configuring and monitoring run and frequency commands and accessing inverter's function codes from the DeviceNet master.

Ports available for the communications card

This interface card can be connected to any one of the three option connection ports (A-, B-, and C-ports) provided on the FRENIC-HVAC.

Note: Once the inverter is equipped with this communications card, no more communications card (e.g., CC-Link and SX-bus communications cards) is allowed on the inverter. Mounting more than one card on the inverter causes the Er4 trip that cannot be reset until those cards are removed except a single card.

DeviceNet specifications

Item	Specifications			
Number of nodes connectable	Max. 64 (including the master)			
MAC ID	0 to 63			
Insulation	500 VDC (photocoupler insulation)			
Transmission rate (Baud rate)	500, 250, or 125 kbps			
Maximum cable length (When using thick cables)	Transmission rate	500 kbps	250 kbps	125 kbps
	Trunk line length	100 m (328 ft)	250 m (800 ft)	500 m (1600 ft)
	Drop line length	6 m (20 ft)	6 m (20 ft)	6 m (20 ft)
	Total length of drop lines	39 m (128 ft)	78 m (256 ft)	156 m (512 ft)
Messages supported	1. I/O Message (Poll, Change of State) 2. Explicit Message			
Vendor ID	319 (Registered name: Fuji Electric Group)			
Device type	AC drive (code: 2)			
Product code	9219			
Applicable device profile	AC Drive			
Number of input/output bytes	Max. 8 bytes for each of input and output * Depending on the format selected. Refer to Table 4.16 "List of Communications Formats Supported."			
Applicable DeviceNet specifications	CIP Specifications Volume 1, Edition 2.2 Japanese version and Volume 3, Edition 1.1 Japanese version			
Node type	Group 2 only server (noncompliant with UCMM)			
Network power consumption	80 mA, 24 VDC (Note) The network power is supplied by an external power source.			

For the items not contained in the table above, the DeviceNet Specifications apply.

DIP switch configuration

The DIP switch specifies the communication data rate (baud rate) and the node address (MAC ID) on DeviceNet as shown below. It offers a choice of baud rates (125, 250, and 500 kbps) and a choice of node address (MAC ID) ranging from 0 to 63. The DIP switch should be configured before the inverter and the communications card are turned ON. If the switch is configured when they are turned ON, the new configuration does not go into effect until they are restarted.

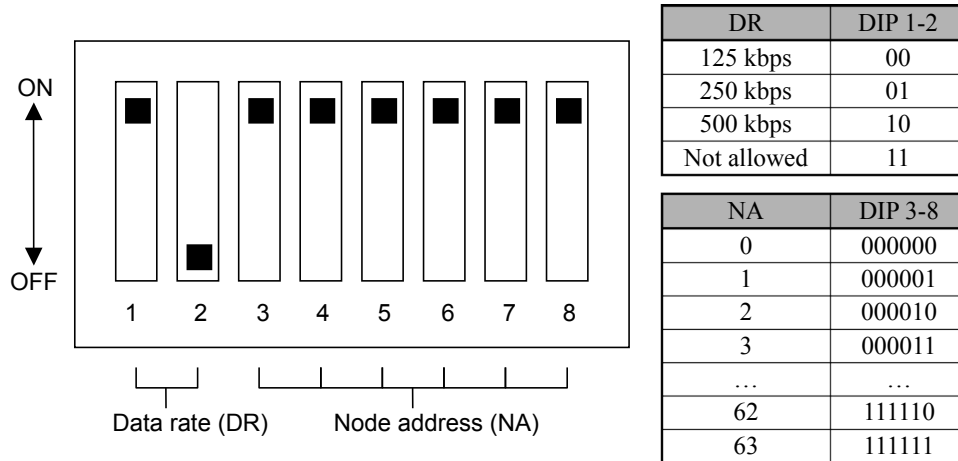

DIP Switch Configuration (showing an example of Data Rate = 500 kbps and Node Address = 63)

Inverter's function codes dedicated to DeviceNet communication

Function code	Description	Factory default	Function code data	Remarks															
y98	Select run/frequency command sources	0	Select from the following choices: <table border="1"> <thead> <tr> <th>y98</th> <th>Frequency command source</th> <th>Run command source</th> </tr> </thead> <tbody> <tr> <td>0</td> <td>Inverter</td> <td>Inverter</td> </tr> <tr> <td>1</td> <td>DeviceNet</td> <td>Inverter</td> </tr> <tr> <td>2</td> <td>Inverter</td> <td>DeviceNet</td> </tr> <tr> <td>3</td> <td>DeviceNet</td> <td>DeviceNet</td> </tr> </tbody> </table>	y98	Frequency command source	Run command source	0	Inverter	Inverter	1	DeviceNet	Inverter	2	Inverter	DeviceNet	3	DeviceNet	DeviceNet	
y98	Frequency command source	Run command source																	
0	Inverter	Inverter																	
1	DeviceNet	Inverter																	
2	Inverter	DeviceNet																	
3	DeviceNet	DeviceNet																	
o27	Select error processing for DeviceNet breaks	0	Refer to the instruction manual of the DeviceNet communications card.																
o28	Set the operation timer to be used in error processing for network breaks	0.0 s	0.0 to 60.0 s																
o31	Select output assembly instance.	0	See Table 4.16.	Restart the inverter to validate the new settings.															
o32	Select input assembly instance	0	See Table 4.16.																
o40 to o43	Assign the function code writing data, 1 to 4.	0000	See Note below.																
o48 to o51	Assign the function code reading data, 1 to 4.	0000	See Note below.																

Note: Configuring o40 to o43 and o48 to o51

Specify the function code group (shown in Table 4.15) and number in a 4-digit hexadecimal notation.

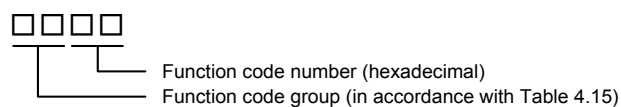

Table 4.15 Function Code Group

Group	Group code	Group name	Group	Group code	Group name	Group	Group code	Group name			
S	2	02h	Command/function data	y	15	0Fh	Link functions	T	30	1Eh	Timer functions
M	3	03h	Monitor data	W	16	10h	Monitor data 2	H1	32	20h	High performance functions
F	4	04h	Fundamental functions	X	17	11h	Alarm 1	U1	34	22h	Customizable logic functions
E	5	05h	Extension terminal functions	Z	18	12h	Alarm 2	J1	36	24h	PID control 1
C	6	06h	Control functions	d	20	14h	Application functions 2	J2	37	25h	PID control 2
P	7	07h	Motor 1 parameters	W1	23	17h	Monitor data 3	J4	39	27h	Pump application functions
H	8	08h	High performance functions	W2	24	18h	Monitor data 4	J5	40	28h	External PID control 1
o	10	0Ah	Option functions	W3	25	19h	Monitor data 5	J6	41	29h	External PID control 2, 3
U	13	0Dh	Customizable logic functions	X1	26	1Ah	Alarm 3				
J	14	0Eh	Application functions 1	K	29	1Dh	Keypad functions				

Example: For F26 F ⇒ Group code 04
 26 ⇒ 1A (hexadecimal) } "041A"

Communications formats

Table 4.16 lists the communications formats supported. The output formats should be selected by function code o31 and the input formats, by function code o32. Restarting the inverter validates the new settings of o31 and o32.

Table 4.16 List of Communications Formats Supported

Function codes o31, o32	Type	Instance ID	Description	Length (words)
o31 = 20	Output (from master to inverter)	20	Basic Speed Control Output	4
o31 = 21 or 0 (Factory default)		21	Extended Speed Control Output	4
o31 = 100		100	Fuji Drive Assembly Output	4
o31 = 102		102	User Defined Assembly Output	8
o31 = 104 (Note)		104	Request for Access to Function Codes	8
o32 = 70	Input (from inverter to master)	70	Basic Speed Control Input	4
o32 = 71 or 0 (Factory default)		71	Extended Speed Control Input	4
o32 = 101		101	Fuji Drive Assembly Input	4
o32 = 103		103	User Defined Assembly Input	8
o32 = 105 (Note)		105	Response to Function Codes Access Request	8

(Note) When o31 is set at 104 (Request for Access to Function Codes), o32 should be set at 105 (Response to Request for Access to Function Codes). For details, refer to the instruction manual of the DeviceNet communications card.

4.4.3.10 CANopen communications card (OPC-COP)

The CANopen communications card is used to connect the FRENIC-HVAC series to a CANopen master unit (e.g., PC and PLC) via a CANopen network. Mounting the communications card on the FRENIC-HVAC allows the user to control the FRENIC-HVAC as a slave unit by configuring run and frequency commands and accessing inverter's function codes from the CANopen master unit.

Ports available for the communications card

This communications card can be connected to the A-port only, out of three option connection ports (A-, B-, and C-ports) provided on the FRENIC-HVAC.

Note: Once the inverter is equipped with this communications card, no more communications card (e.g., DeviceNet and SX-bus communications cards) is allowed on the inverter. Mounting more than one card on the inverter causes the Er4 trip that cannot be reset until those cards are removed except a single card.

CANopen specifications

Item	Specifications	Remarks
Physical layer	CAN (ISO11898)	
Transmission speed (Baud rate)	20, 50, 125, 250, 500, 800 kbps, 1 Mbps	Specified by o32
Maximum cable length	2500 m (8200 ft) (at 20 kbps) to 25 m (82 ft) (at 1 Mbps)	
Node ID	1 to 127	Specified by o31
Applicable profile	Compliant with the following profiles; - CiA DS-301 Ver. 4.02 - CiA DS-402 Ver. 2.0 with Velocity Mode	

Inverter's function codes dedicated to CANopen communication

The inverter's function codes listed below should be configured for performing communication between the communications card and CANopen master unit.

Inverter's Function Codes Required for CANopen Communication

Function code	Function code name	Factory default	Data setting range	Description
o31 *1	Node ID setting	0	0 to 255 (Valid range: 0 to 127)	Setting 0 or 128 or greater is regarded as 127
o32 *1	Baud rate setting	0	0 to 255 (Valid range: 0 to 7)	0: 125 kbps 5: 500 kbps 1: 20 kbps 6: 800 kbps 2: 50 kbps 7: 1 Mbps 3: 125 kbps 8 to 255: 1 Mbps 4: 250 kbps

*1 After configuring the function code o31 or o32, restart the inverter or send ResetNode command from the CANopen master to validate the new setting.

The table below lists the other related inverter's function codes. Configure those function codes if necessary.

Related Inverter's Function Codes

Function code	Function code name	Factory default	Data setting range	Description															
o27	Select error processing for CANopen network breaks	0	0 to 15																
o28	Set the operation timer to be used in error processing for network breaks	0	0 to 60.0 s																
o40 to o43 *2	Assign the function code to be written via RPDO 3	0x0000	0x0000 to 0xFFFF	Specify the function code as follows: 0xXX■■■ XX: Group (Refer to the table below.) ■■■: Number ex. F07 → 0x0407															
o48 to o51 *2	Assign the function code to be monitored via TPDO 3	0x0000	0x0000 to 0xFFFF	Same as above.															
y98	Select run/frequency command sources	0	0 to 3	Select from the following choices: <table border="1" style="margin-left: 20px;"> <thead> <tr> <th>y98</th> <th>Frequency command source</th> <th>Run command source</th> </tr> </thead> <tbody> <tr> <td>0</td> <td>Inverter</td> <td>Inverter</td> </tr> <tr> <td>1</td> <td>CANopen</td> <td>Inverter</td> </tr> <tr> <td>2</td> <td>Inverter</td> <td>CANopen</td> </tr> <tr> <td>3</td> <td>CANopen</td> <td>CANopen</td> </tr> </tbody> </table>	y98	Frequency command source	Run command source	0	Inverter	Inverter	1	CANopen	Inverter	2	Inverter	CANopen	3	CANopen	CANopen
y98	Frequency command source	Run command source																	
0	Inverter	Inverter																	
1	CANopen	Inverter																	
2	Inverter	CANopen																	
3	CANopen	CANopen																	

*2 After configuring the function codes o40 to o43 and o48 to o51, restart the inverter or send Reset Node command from the CANopen master to validate the new setting.

Function Code Group (Function codes o40 to o43 and o48 to o51)

Group	Group code	Group name	Group	Group code	Group name	Group	Group code	Group name
S	2 02h	Command/function data	y	15 0Fh	Link functions	T	30 1Eh	Timer functions
M	3 03h	Monitor data	W	16 10h	Monitor data 2	H1	32 20h	High performance functions
F	4 04h	Fundamental functions	X	17 11h	Alarm 1	U1	34 22h	Customizable logic functions
E	5 05h	Extension terminal functions	Z	18 12h	Alarm 2	J1	36 24h	PID control 1
C	6 06h	Control functions	d	20 14h	Application functions 2	J2	37 25h	PID control 2
P	7 07h	Motor 1 parameters	W1	23 17h	Monitor data 3	J4	39 27h	Pump application functions
H	8 08h	High performance functions	W2	24 18h	Monitor data 4	J5	40 28h	External PID control 1
o	10 0Ah	Option functions	W3	25 19h	Monitor data 5	J6	41 29h	External PID control 2, 3
U	13 0Dh	Customizable logic functions	X1	26 1Ah	Alarm 3			
J	14 0Eh	Application functions 1	K	29 1Dh	Keypad functions			

Communication

The communications card is a slave of CANopen and supports the following services.

Item	Services	Remarks
PDO	- 3 RPDOs / 3 TPDOs - Sync, Cyclic and Async (Change of state event) supported for 3 TPDOs	All PDO cannot be remapped by PDO Mapping parameters.
SDO	- Expedited and Segmented protocol supported - Only Default SDO supported	Block protocol not supported
Emergency (EMCY) Object	EMCY Producer	EMCY Consumer not supported
Network Management (NMT)	NMT Slave (DS-301 state machine) Guarding Heartbeat Producer Heartbeat Consumer Boot-up Protocol	NMT master not supported

4.4.3.11 LONWORKS communications card (OPC-LNW)

The LONWORKS communications card is used to connect the FRENIC-HVAC series to peripheral equipment (e.g., LONWORKS master unit) via LONWORKS network. Mounting the communications card on the FRENIC-HVAC enables the user to control the FRENIC-HVAC as a slave unit by configuring and monitoring run and frequency commands and accessing inverter's function codes from the LONWORKS master. It also enables data exchange with peripheral equipment.

Ports available for the communications card

This communications card can be connected to the A-port only, out of three option connection ports (A-, B-, and C-ports) provided on the FRENIC-HVAC.

Note: Once the inverter is equipped with this communications card, no more communications card (e.g., DeviceNet communications cards) is allowed on the inverter. Mounting more than one card on the inverter causes the Er4 trip that cannot be reset until those cards are removed except a single card.

LONWORKS specifications

Item	Specifications
Transmission speed (Baud rate)	78 kbps
Profile	LonMark 3.3 Variable Speed Motor Drive functional Profile Ver. 1.1
Communication topology	Free topology
Network variables (NVs)	62 (Node objects: 3, VSD objects: 59)
Communications IC	Smart Transceiver (FT3120-E4S40)
Communications transceiver	TP/FT-10 (Free topology)
Network protocol	LonTalk protocol
Configuration properties (CPs)	24

4.4.3.12 Ethernet communications card (OPC-ETH)

Mounting the Ethernet communications card on the FRENIC-HVAC enables the user to control the FRENIC-HVAC as a slave unit from master equipment connected via Ethernet network by configuring and monitoring run and frequency commands and accessing inverter's function codes. It also enables data exchange with peripheral equipment.

Ports available for the communications card

The communications card can be connected to the A-port only, out of three option connection ports (A-, B-, and C-ports) provided on the inverter.

Note: Once the inverter is equipped with this card, no more different type of communications card (e.g., DeviceNet communications card) is allowed on the inverter. Mounting more than one card on the inverter causes the Er4 trip that cannot be reset until those cards are removed except a single card.

Specifications

Item	Service taka	Remarks
Supported protocols	Modbus/TCP Server Ethernet/IP Server Allen Bradley CSP Server (also known as "PCCC" and "AB Ethernet") BACnet/IP Server	
Ethernet port	IEEE 802.3 10/100BASE-T Ethernet compliant. Shielded RJ-45 connectors accept the standard CAT5-type 8 of unshielded twisted-pair (UTP) cables. MDI/MDI-X auto-crossover allows the use of any combination of straight-through and cross-over Ethernet cables. Transmission distance: 100 m (328 ft) or less	
USB port	USB 2.0 port with mini-B connector provides composite USB device functionality. USB connection enables product identification and firmware updating. The communications card works as a standard USB mass storage device ("flash drive") to copy configuration files and customize web pages.	

Function code settings

Function code	Function	Factory default	Function code data to be set	Description										
y98	Select run/frequency command sources	0	3	<table border="0"> <tr> <td>Freq. command</td> <td>Run command</td> </tr> <tr> <td>0: Inverter</td> <td>Inverter</td> </tr> <tr> <td>1: Ethernet</td> <td>Inverter</td> </tr> <tr> <td>2: Inverter</td> <td>Ethernet</td> </tr> <tr> <td>3: Ethernet</td> <td>Ethernet</td> </tr> </table>	Freq. command	Run command	0: Inverter	Inverter	1: Ethernet	Inverter	2: Inverter	Ethernet	3: Ethernet	Ethernet
Freq. command	Run command													
0: Inverter	Inverter													
1: Ethernet	Inverter													
2: Inverter	Ethernet													
3: Ethernet	Ethernet													

The table below lists the error processing to apply when a timeout occurs.

Function code		Descriptions	Remarks
o27	o28		
0, 4 to 9	--	Immediately coast to a stop and trip with Er5.	
1	0.0 to 60.0s	After the time specified by o28, coast to a stop and trip with Er5.	
2	0.0 to 60.0s	If the communications link is restored within the time specified by o28, ignore the communications error. If a timeout occurs, coast to a stop and trip with Er5.	
3, 13 to 15	--	Keep the current operation, ignoring the communications error. (No Er5 trip occurs.)	
10	--	Immediately decelerate to a stop. After stop, trip with Er5.	Specify the deceleration time with the inverter's function code F08.
11	0.0 to 60.0s	After the time specified by o28, decelerate to a stop. After stop, trip with Er5.	Same as above.
12	0.0 to 60.0s	If the communications link is restored within the time specified by o28, ignore the communications error. If a timeout occurs, decelerate to a stop. After stop, trip with Er5.	Same as above.

4.5 Backup Battery

4.5.1 Outline

The backup battery is used to back up the real-time clock (RTC) when no power is applied to the inverter. It is provided as an option.

Model	OPK-BP
Battery voltage/capacity	3.6 V/1100 mAh
Type	Lithium-thionyl chloride battery
Replacement interval (as a guide)	5 years (Battery ambient temperature 60°C (140°F), Inverter not powered)

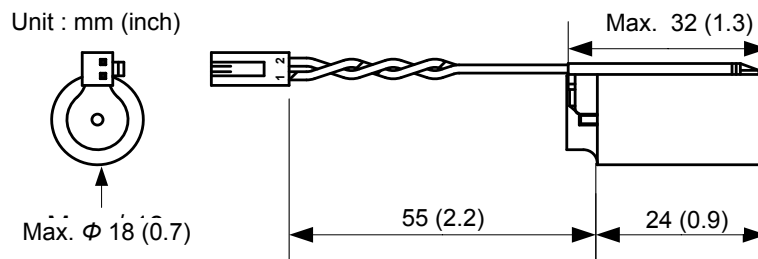

Figure 4.13 External View and Dimensions

⚠ WARNING

Safety Precautions

The lithium thionyl chloride battery, which contains lithium (dangerous material) and thionyl chloride (deleterious material), is a hermetically sealed, high-energy density battery. Improper use of the battery could cause deformation, leakage of battery fluid (Liquid inside the battery leaks out), heat generation, battery-rupture or fire, or produce irritant and corrosive gas. This could result in bodily injury or inverter fault. Be sure to observe the following precautions.

- Take care not to swallow the battery.
- Do not apply excessive force to the positive terminal of the battery.
- Do not drop the battery.
- Do not short-circuit the battery terminals.
- Do not charge the battery.
- Do not discharge the battery forcedly.
- Never heat the battery.
- Never put the battery into fire.
- Never disassemble the battery.
- Do not deform the battery by pressure.
- When loading the battery into the inverter, take care not to insert it in wrong direction.
- Do not touch the fluid leaked from the battery.
- Do not leave a damaged battery in the inverter.

⚠ CAUTION

When storing the battery, keep it away from direct sunlight, high temperature, high humidity, and rainwater.

The battery used in this product is a so-called primary battery, so dispose of it in accordance with local code and regulations.

4.5.2 Loading the battery

CAUTION

Before proceeding to the loading procedure, be sure to shut down the power.

Fire or an accident could occur.

- * For the calendar clock setting, refer to Chapter 5, Section 5.6.2.3 "Setting the calendar clock."
- * Replacing the battery may cause a light alarm "dtL." To reset the alarm state, set the calendar clock again and press the  key.

- (1) Remove the front cover.

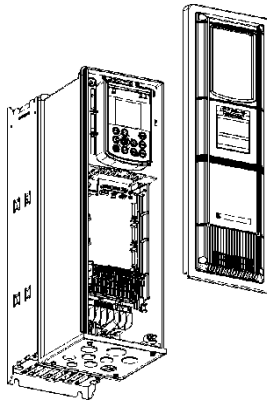

- (2) Load the battery to the location shown below.

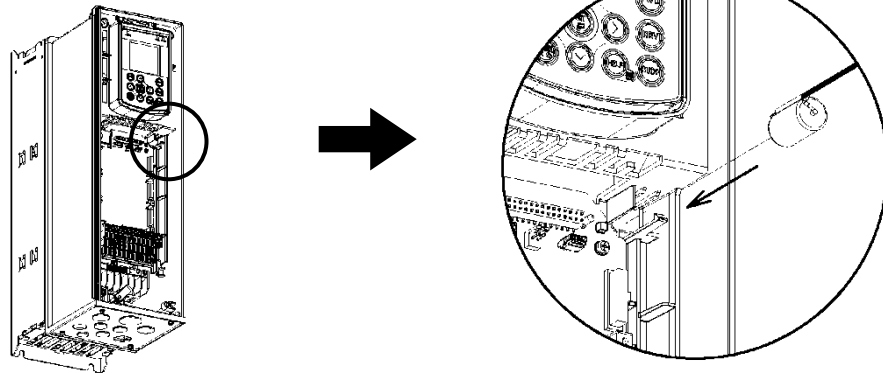

- (3) Hook the battery harness over the boss and then fully insert the connector into connector CN11 on the control printed circuit board.

FRN005AR1 ■-2U or below,
FRN010AR1 ■-4U/5U or below.

FRN007AR1 ■-2U to FRN060AR1 ■-2U,
FRN015AR1 ■-4U to FRN125AR1 ■-4U,
FRN015AR1 ■-5U to FRN150AR1 ■-5U.

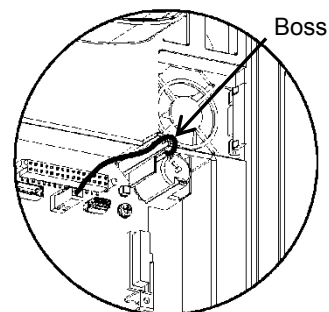
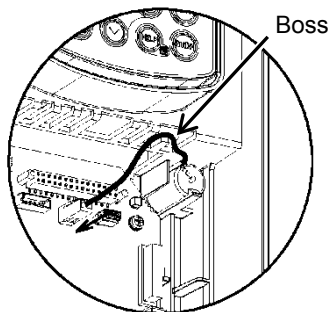

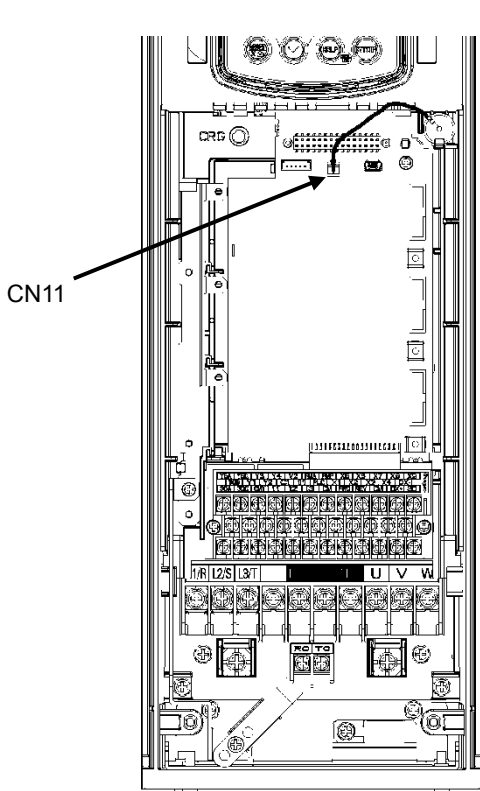

Figure 4.14 Battery Loaded
(FRN005AR1-2U or below,
FRN010AR1-4U/5U or below.)

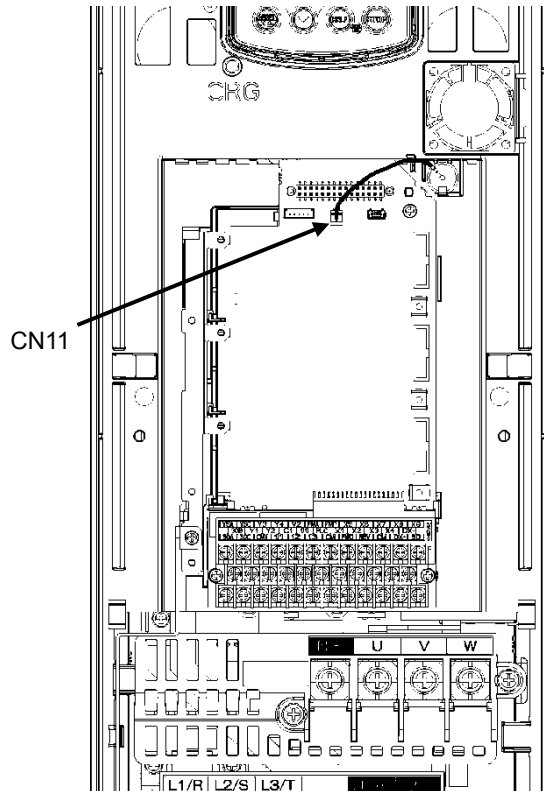

Figure 4.15 Battery Loaded
(FRN007AR1-2U to FRN060AR1-2U,
FRN015AR1-4U to FRN125AR1-4U,
FRN015AR1-5U to FRN150AR1-5U.)

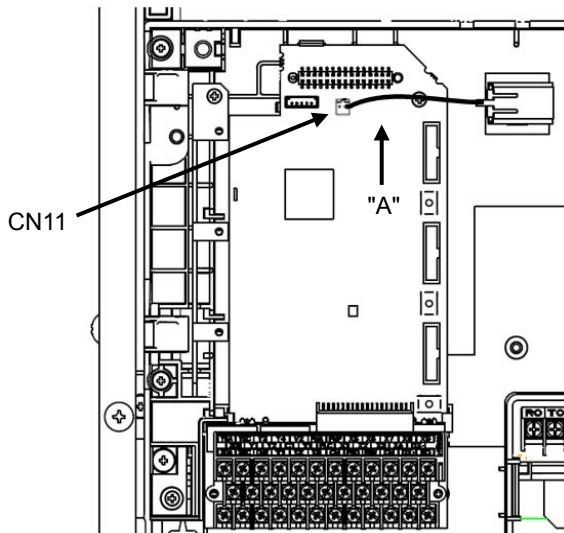
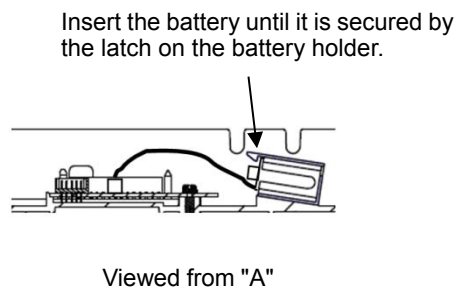

Figure 4.16 Battery Loaded
(FRN075AR1S-2U or above and FRN150AR1S-4U or above, FRN200AR1S-5U or above)



4.5.3 Battery replacement procedure

Remove the battery from the inverter in the reverse order of the loading procedure and then load a new battery.

 CAUTION
--

Before proceeding to the replacement procedure, be sure to shut down the power.

Fire or an accident could occur.

* For the calendar clock setting, refer to Chapter 5, Section 5.6.2.3 "Setting the calendar clock."

4.5.4 About air transport of batteries

In the International Air Transport Association (IATA) Dangerous Goods Regulations 44th Edition (effective date of January 1, 2003), the "Transportation regulations for lithium and lithium ion cells and batteries" have been revised.

The backup battery is classified into non-dangerous goods (Lithium content 1.0 g or less: Not in Class 9) so that 24 batteries or less are exempt from the regulations. However, 25 batteries or more require packaging compliant with the regulations. For details, consult your Fuji Electric representative. (as of April, 2011)

Chapter 5

PREPARATION AND TEST RUN

This chapter details the operating environment, storage environment, installation, wiring, basic connection examples, names and functions of the keypad components, operation using the keypad, and test run procedure.

Contents

5.1	Mounting and Wiring the Inverter.....	5-1
5.1.1	Installing the inverter	5-1
5.1.2	Wiring	5-4
5.1.2.1	Removing and mounting the front cover and the wiring plate	5-4
5.1.2.2	Input ferrite core diameter.....	5-7
5.1.3	Screw specifications and recommended wire sizes.....	5-7
5.1.3.1	Main circuit terminals	5-7
5.1.3.2	Control circuit terminals (Common to all inverter types)	5-7
5.1.4	Conduits	5-7
5.1.5	Wiring precautions	5-8
5.1.6	Wiring of main circuit terminals and grounding terminals.....	5-9
5.1.7	Wiring for control circuit terminals.....	5-16
5.1.8	Setting up the slide switches	5-19
5.1.9	USB port	5-20
5.2	Mounting and Connecting a Keypad.....	5-21
5.2.1	Parts required for connection	5-21
5.2.2	Mounting procedure	5-21
5.3	Operation Using the Keypad.....	5-24
5.3.1	LCD monitor, keys and LED indicators on the keypad.....	5-24
5.4	Overview of Operation Modes.....	5-28
5.5	Running Mode	5-29
5.5.1	Monitoring the running status	5-29
5.5.2	Setting up frequency and PID commands	5-32
5.5.3	Running/stopping the motor.....	5-36
5.5.4	Remote and local modes	5-36
5.5.5	Changing from keypad operation to external signal (terminal block) operation	5-37
5.5.6	Monitoring light alarms.....	5-37
5.6	Programming Mode	5-38
5.6.1	Quick Setup.....	5-40
5.6.2	Start-up.....	5-40
5.6.2.1	Set Display Language.....	5-41
5.6.2.2	Function-Specific Initialization.....	5-42
5.6.2.3	Date/Time Settings	5-42
5.6.2.4	Set Display	5-45
5.6.3	Function Codes	5-46

5.6.3.1	Setting up function codes	5-47
5.6.3.2	Confirm Data.....	5-49
5.6.3.3	Confirm Changed Function Code.....	5-49
5.6.3.4	Copying data	5-49
5.6.3.5	Set Timer Operation	5-61
5.6.3.6	Initialize Data.....	5-64
5.6.4	Inverter Information	5-65
5.6.4.1	Confirm Power Level	5-65
5.6.4.2	Confirm Operational Status.....	5-66
5.6.4.3	Check Status of Input/Output Signal.....	5-69
5.6.4.4	View Maintenance Information.....	5-71
5.6.4.5	View Unit Information	5-75
5.6.5	Alarm Information	5-76
5.6.5.1	Confirm Alarm History	5-76
5.6.5.2	Confirm Light Alarm History.....	5-80
5.6.5.3	Retry History.....	5-80
5.6.6	User Config.....	5-81
5.6.6.1	Quick Setup.....	5-81
5.6.6.2	Password	5-81
5.6.7	Tools.....	5-85
5.6.7.1	Monitor PID Control Status	5-85
5.6.7.2	Monitor Multiple Unit Controls	5-88
5.6.7.3	Monitor Customized Logic (CLogic).....	5-91
5.6.7.4	Resonance Avoidance.....	5-92
5.6.7.5	Load Factor Measurement.....	5-93
5.6.7.6	Communication Debug	5-96
5.7	Alarm Mode.....	5-97
5.7.1	Releasing the alarm and switching to Running mode	5-97
5.7.2	Displaying the alarm history	5-97
5.7.3	Displaying the status of inverter at the time of alarm	5-97
5.7.4	Test run procedure.....	5-98
5.7.5	Checking prior to powering ON.....	5-99
5.7.6	Powering ON and checking.....	5-100
5.7.7	Selecting a desired motor drive control.....	5-100
5.7.8	Function code basic settings < 1 >	5-101
5.7.9	Function code basic settings and tuning < 2 >	5-103
5.7.10	Running the inverter for motor operation check	5-106
5.7.11	Preparation for practical operation.....	5-107

5.1 Mounting and Wiring the Inverter

5.1.1 Installing the inverter

(1) Mounting base

Install the inverter on a base made of metal or other non-flammable material. Do not mount the inverter upside down or horizontally.

⚠ WARNING

Install the inverter on a base made of metal or other non-flammable material.
Otherwise, a fire could occur.

(2) Clearances

Ensure that the minimum clearances indicated in Figure 5.1 and Table 5.1 are maintained at all times. When installing the inverter in the panel of your system, take extra care with ventilation inside the panel as the ambient temperature easily rises. Do not install the inverter in a small panel with poor ventilation.

■ Mounting two or more inverters

When mounting two or more inverters in the same unit or panel, basically lay them out side by side. When mounting them necessarily one above the other, be sure to separate them with a partition plate or the like so that any heat radiating from an inverter will not affect the one(s) above.

Table 5.1 Clearances mm (inch)

Inverter capacity	A	B	C
230 V class series: 1 to 60 HP	10	100	100
460 V class series: 1 to 125 HP	(0.4)	(3.9)	(3.9)
575 V class series: 1 to 150 HP			
230 V class series: 75 to 125 HP	50	100	100
460 V class series: 150 to 450 HP	(2)	(3.9)	(3.9)
575 V class series: 200 to 300 HP			
460 V class series: 500 to 1000 HP	50	100	100
	(2)	(3.9)	(3.9)

C: Space required in front of the inverter unit

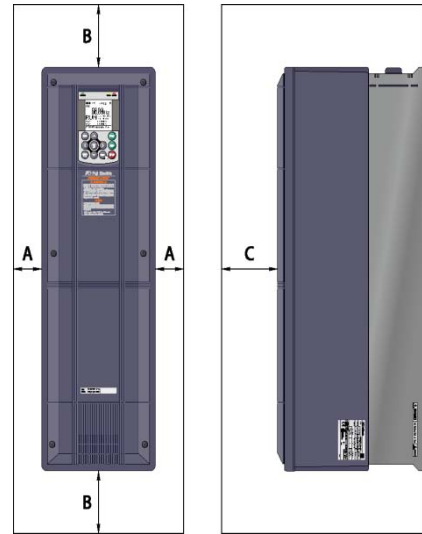

Figure 5.1 Mounting Direction and Required Clearances

■ Mounting inverters side by side without any clearance

The 230 V class series of 25 HP or below and 460/575 V ones of 50 HP or below can be mounted side by side without any clearance under the following conditions.

NEMA/UL TYPE1: Ambient temperature -10 to +40°C (14 to 104°F)

NEMA/UL TYPE12: Ambient temperature -10 to +30°C (14 to 86°F)

■ Employing external cooling

UL open type-rated inverters (230 V class series inverters of 75 HP or above and 460 V ones of 150 HP or above) can employ external cooling by changing the positions of the mounting bases.

In external cooling, the heat sink, which dissipates about 70% of the total heat (total loss) generated into air, is situated outside the equipment or the panel. The external cooling, therefore, significantly reduces heat radiating inside the equipment or panel.

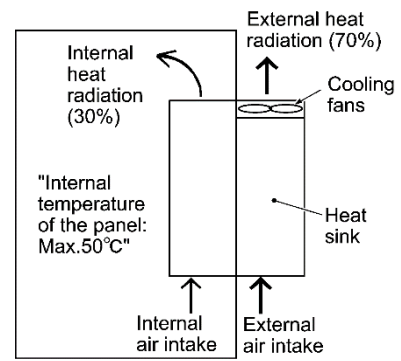

Figure 5.1-1 External Cooling

⚠ CAUTION
Prevent lint, paper fibers, sawdust, dust, metallic chips, or other foreign materials from getting into the inverter or from accumulating on the heat sink.
A fire or accident could occur.

To employ external cooling, change the positions of the top and bottom mounting bases from the edge to the center of the inverter as shown in Figure 5.1-2.

Screws differ in size and count for each inverter. Refer to the table below.

Table 5.1-1 Screw Size, Count and Tightening Torque

Inverter type	Base fixing screw (Screw size and q'ty)	Case fixing screw (Screw size and q'ty)	Tightening torque (N•m)
FRN075AR1S-2U FRN100AR1S-2U	M6 × 20 (3 pcs each for upper and lower sides)	M6 × 12 (3 pcs for upper side)	5.8
FRN125AR1S-2U FRN150AR1S-4U FRN200AR1S-4U	M5 × 12 (7 pcs each for upper and lower sides)	M5 × 12 (7 pcs for upper side)	3.5
FRN250AR1S-4U FRN300AR1S-4U FRN200AR1S-5U FRN250AR1S-5U FRN300AR1S-5U	M5 × 16 (7 pcs each for upper and lower sides)	M5 × 16 (7 pcs for upper side)	3.5
FRN350AR1S-4U FRN450AR1S-4U	M5 × 16 (8 pcs each for upper and lower sides)	M5 × 16 (8 pcs for upper side)	3.5
FRN500AR1S-4U FRN600AR1S-4U FRN800AR1S-4U	M5 × 16 (2 pcs each for upper and lower sides) M6 × 20 (6 pcs each for upper and lower sides)	M5 × 16 (2 pcs each for upper and lower sides) M6 × 20 (6 pcs each for upper and lower sides)	3.5 5.8
FRN900AR1S-4U FRN1000AR1S-4U	M8 × 20 (8 pcs each for upper and lower sides)	M8 × 20 (8 pcs each for upper and lower sides)	13.5

- 1) Remove all of the base fixing screws and the case fixing screws from the top of the inverter.
- 2) Move the top mounting base to the center of the inverter and secure it to the case fixing screw holes with the base fixing screws. (After changing the position of the top mounting base, some screws may be left unused.)
- 3) Remove the base fixing screws from the bottom of the inverter, move the bottom mounting base to the center of the inverter, and secure it with the base fixing screws, just as in step 2). (Inverters of 450 HP or below have no case fixing screws on the bottom.)

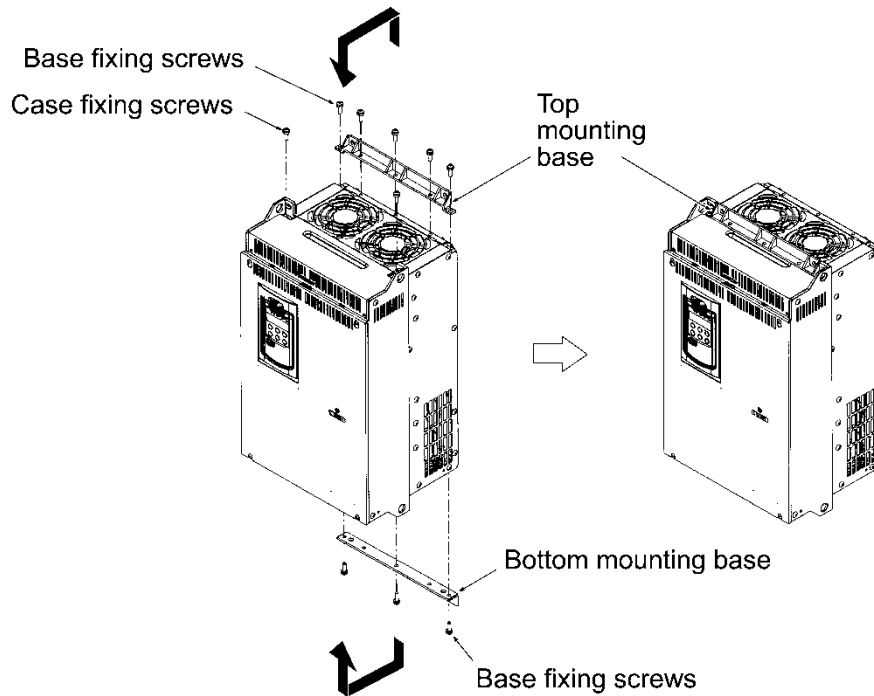

Figure 5.1-2 Changing the Positions of the Top and Bottom Mounting Bases

⚠ CAUTION

When changing the positions of the top and bottom mounting bases, use only the specified screws.
A fire or accident could occur.

5.1.2 Wiring

Before wiring, remove the front cover and wiring plate and then set conduits on the wiring plate. After wiring, mount the wiring plate and front cover back into place.

5.1.2.1 Removing and mounting the front cover and the wiring plate

(1) 230V class series 60HP, 460V class series 125HP, 575V class series 150 HP or less

- ① Loosen the (four or six) screws on the front cover, hold the right and left ends of the front cover, and remove it towards you.
- ② Loosen the four screws on the wiring plate, hold the right and left ends of the wiring plate, and remove it downwards.

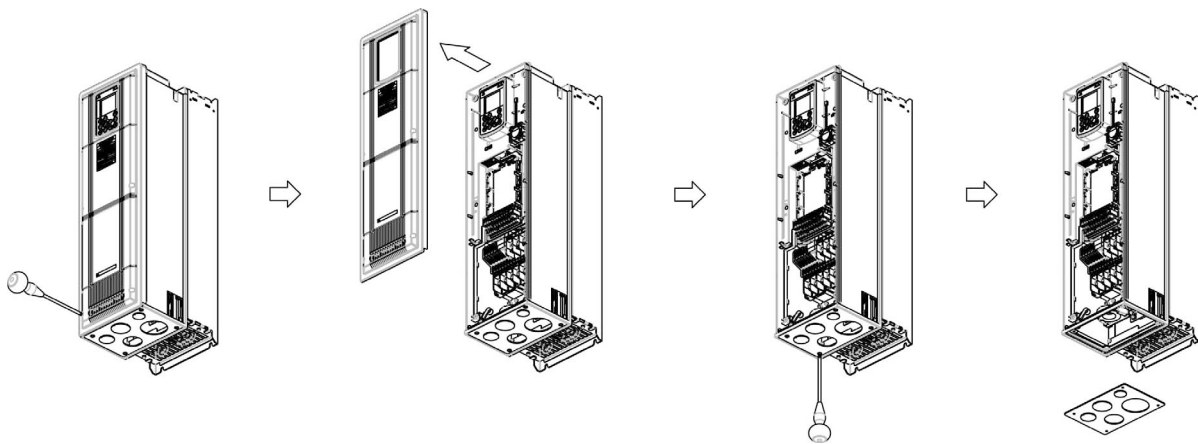

Figure 5.2 Removing the Front Cover and the Wiring Plate (FRN050AR1M-4U)

- Tip** - The wiring plate can be removed even with the front cover being mounted.
- To expose the control printed circuit board (control PCB), remove the front cover.

(2) 230V class series 75 to 125HP and 460V class series 150 to 1000HP 575V class series 200 to 300 HP

- ① Loosen the screws on the front cover, hold the right and left ends of the front cover, and slide it up to remove it.
- ② After making the necessary wiring connections, align the top of the front cover with the holes on the unit and reattach the cover by reversing the process illustrated in Figure 2.3.

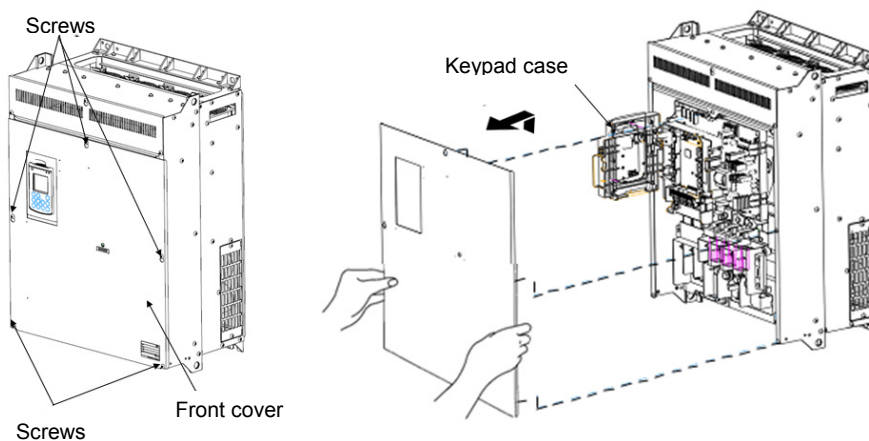

Figure 5.3 Removing the Front Cover and the Wiring Plate (FRN110AR1S-4□)

(3) Punching out semi-perforated sections in the wiring plate and setting conduits

- ① Lightly tap the semi-perforated sections from the inside of the wiring plate using the hand grip of a screwdriver or the like to punch them out.
- ② Set the conduits on the wiring plate and then carry out wiring.

Note Take care not to get injured by the edge of the parts.

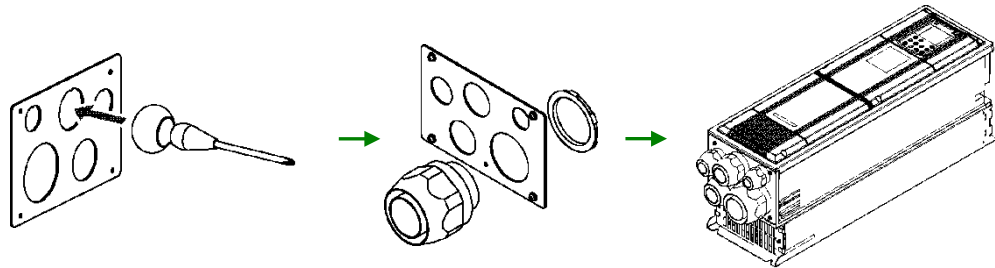
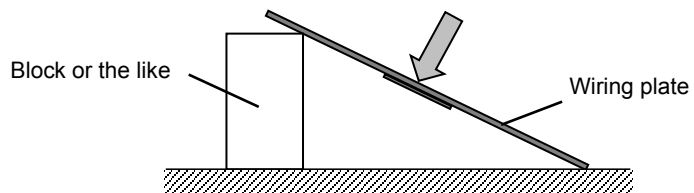
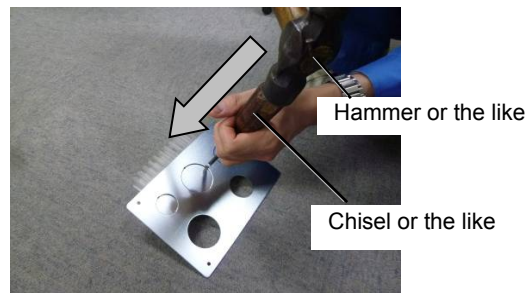
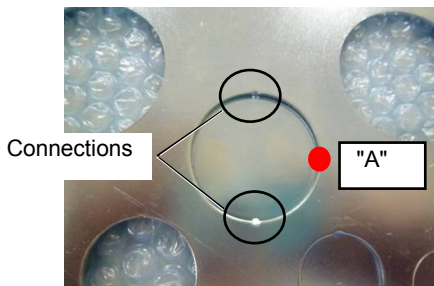

Figure 5.3 Punching Out Semi-perforated Sections in the Wiring Plate and Setting Conduits

If it is difficult to punch semi-perforated sections out of the wiring plate

Apply a rod with a sharp tip (e.g., chisel) to point "A" shown below and tap it using a hammer.



Take care not to deform the wiring plate.

(4) Wiring the main circuit power input wires

For 230 V class series inverters of 7.5 to 60 HP and 460 V ones of 15 to 125 HP, follow the wiring procedure given below for smooth wiring. For 575V series, ferrite core is not required.

- ① Remove the screws and press the ends of the ferrite core support inwards to release the ferrite core from the main circuit terminal block.
- ② Connect the inverter grounding wire.
- ③ Pass the main circuit power input wires of the inverter through the ferrite core and then connect those wires to the terminal block.
- ④ Put the ferrite core and its support back into place.

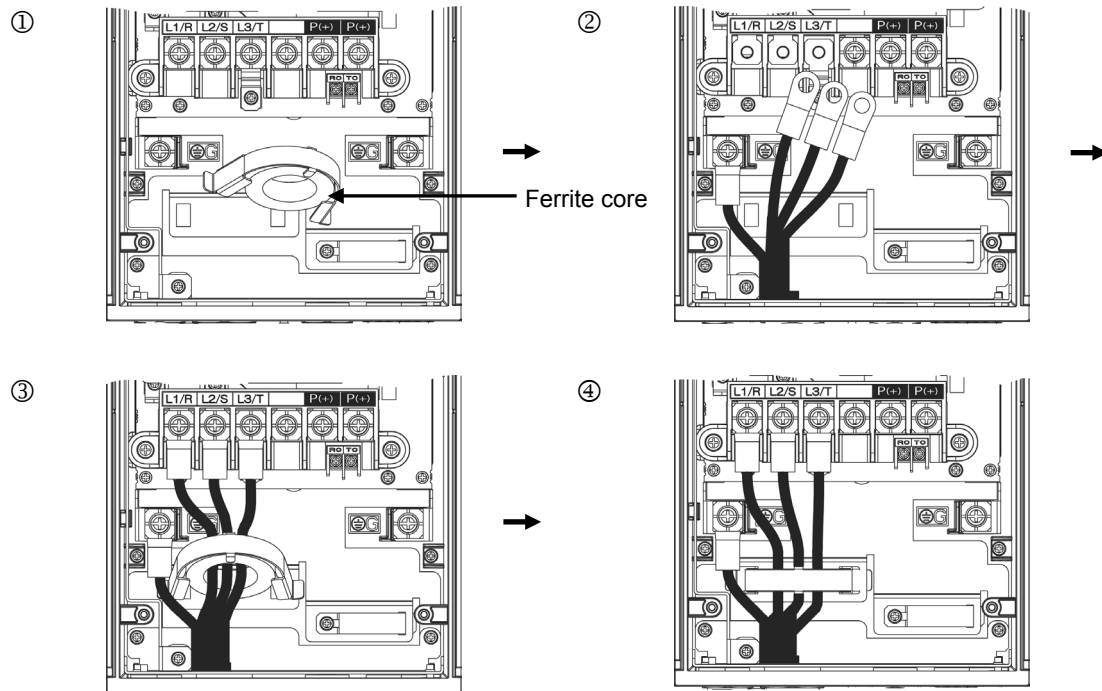

(5) Mounting the wiring plate and the front cover

After wiring, mount the wiring plate and front cover back into place. (Tightening torque: 1.8 N·m (15.9 lb-in) (M4))

5.1.2.2 Input ferrite core diameter

The input ferrite core size is shown in the table below.

Inverter type	Inside diameter of input ferrite core mm (inch)
FRN007-015AR1 ■-2U FRN015-030AR1 ■-4U	31(1.22)
FRN020-025AR1 ■-2U FRN040-050AR1 ■-4U	31(1.22)
FRN030-040AR1 ■-2U FRN060-075AR1 ■-4U	39(1.54)
FRN050-060AR1 ■-2U FRN100-125AR1 ■-4U	50(1.97)



5.1.3 Screw specifications and recommended wire sizes

5.1.3.1 Main circuit terminals

The screw specifications and wire sizes are shown in Chapter 2, Section 2.3.2.1 "Main circuit terminals."

Note that the terminal arrangements differ depending on the inverter types.

Use crimp terminals covered with an insulation sheath or with an insulation tube.

 WARNING 	
When the inverter power is ON, a high voltage is applied to the following terminals. Main circuit terminals: L1/R, L2/S, L3/T, P(+), N(-), U, V, W, R0, T0, R1, T1, AUX-contact (30A, 30B, 30C, Y5A, Y5C)	
Insulation level	
Main circuit—Enclosure	: Basic insulation (Overvoltage category III, Pollution degree 2)
Main circuit—Control circuit	: Reinforced insulation (Overvoltage category III, Pollution degree 2)
Relay output—Control circuit	: Reinforced insulation (Overvoltage category II, Pollution degree 2)
An electric shock may occur.	

5.1.3.2 Control circuit terminals (Common to all inverter types)

The control circuit terminal arrangement, screw sizes, and tightening torque are shown in Chapter 2, Section 2.3.2.2 "Control circuit terminals (Common to all inverter types)."

The control circuit terminals are common to all inverter types regardless of their capacities.

5.1.4 Conduits

To ensure NEMA/UL Type 1 rating, mount conduits on the wiring plate in wiring. The conduits should be selected according to the number of wires to be connected and the wire size.

Chapter 2, Sections 2.4.1 "Conduits" give the sizes of the conduits to be applied when the wires of the recommended sizes are used. Their sizes and mounting positions differ depending upon the inverter capacity.

5.1.5 Wiring precautions

Follow the rules below when performing wiring for the inverter.

WARNING

- If no zero-phase current (earth leakage current) detective device such as a ground-fault relay is installed in the upstream power supply line in order to avoid the entire power supply system's shutdown undesirable to factory operation, install a residual-current-operated protective device (RCD)/earth leakage circuit breaker (ELCB) individually to inverters to break the individual inverter power supply lines only.
Otherwise, a fire could occur.
- When wiring the inverter to the power source, insert a recommended molded case circuit breaker (MCCB) or residual-current-operated protective device (RCD)/earth leakage circuit breaker (ELCB) (with overcurrent protection) in the path of each pair of power lines to inverters. Use the recommended devices within the recommended current capacity.
- Use wires in the specified size.
- Tighten terminals with specified torque.
Otherwise, a fire could occur.
- When there is more than one combination of an inverter and motor, do not use a multicore cable for the purpose of handling their wirings together.
- Do not connect a surge killer to the inverter's output (secondary) circuit.
Doing so could cause a fire.
- Be sure to ground the inverter's grounding terminals G.
Otherwise, an electric shock or a fire could occur.
- Qualified electricians should carry out wiring.
- Be sure to perform wiring after turning the power OFF.
Otherwise, an electric shock could occur.
- Be sure to perform wiring after installing the inverter unit.
Otherwise, an electric shock or injuries could occur.
- Ensure that the number of input phases and the rated voltage of the product match the number of phases and the voltage of the AC power supply to which the product is to be connected.
Otherwise, a fire or an accident could occur.
- Do not connect the power supply wires to the inverter output terminals (U, V, and W).
Doing so could cause fire or an accident.
- In general, sheaths of the control signal wires are not specifically designed to withstand a high voltage (i.e., reinforced insulation is not applied). Therefore, if a control signal wire comes into direct contact with a live conductor of the main circuit, the insulation of the sheath might break down, which would expose the signal wire to a high voltage of the main circuit. Make sure that the control signal wires will not come into contact with live conductors of the main circuit.
Doing so could cause an accident or an electric shock.

5.1.6 Wiring of main circuit terminals and grounding terminals

Perform wiring in the order given below. This section also outlines terminal functions.

① Primary grounding terminal (⚡G) for inverter enclosure

Two grounding terminals (⚡G) are not exclusive to the power supply wiring (primary circuit) or motor wiring (secondary circuit).

Be sure to ground either of the two grounding terminals for safety and noise reduction. The inverter is designed for use with safety grounding to avoid electric shock, fire and other disasters.

- 1) Ground the inverter in compliance with the national or local electric code.
- 2) Use a thick grounding wire with a large surface area and keep the wiring length as short as possible.

② Inverter output terminals U, V, and W and secondary grounding terminals (⚡G) for motor

Inverter's output terminals should be connected as follows:

- 1) Connect the three wires of the 3-phase motor to terminals U, V, and W, aligning the phases each other.
- 2) Connect the grounding wire of output lines (U, V, and W) to the grounding terminal (⚡G).

Note When there is more than one combination of an inverter and motor, do not use a multicore cable for the purpose of handling their wirings together.

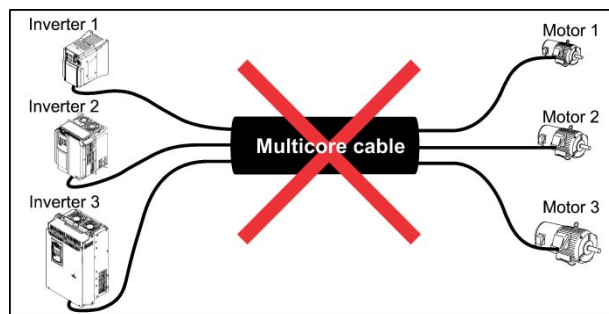

Note Use shielded wires for the motor cable and route the cable as short as possible. Clamp the shield to the specified point inside the inverter.

③ DC reactor terminals P1 and P(+) (on 230 V class series inverters of 75 HP or above and 460 V ones of 150 HP or above and 575 V ones of 150 HP or above)

Connect terminals [P1] and [P(+)] of a DC reactor (DCR) bundled as standard for power factor correction to these terminals.

- Note**
- The wiring length should be 10 m (33 ft) or below.
 - When an AC power supply is connected, be sure to connect a DCR.
 - If a PWM converter is connected to the inverter, no DCR is required.

④ DC link bus terminals P(+) and N(-)

For connection to the DC link bus.

When you need to use the DC link bus terminals P(+) and N(-), consult your Fuji Electric representative.

⑤ Main circuit power input terminals L1/R, L2/S, and L3/T (three-phase input)

The three-phase input power lines are connected to these terminals.

- 1) For safety, make sure that the molded case circuit breaker (MCCB) or magnetic contactor (MC) is turned OFF before wiring the main circuit power input terminals.

-
- 2) Connect the main circuit power supply wires (L1/R, L2/S and L3/T) to the input terminals of the inverter via an MCCB or residual-current-operated protective device (RCD)/earth leakage circuit breaker (ELCB)*, and an MC if necessary.

It is not necessary to align phases of the power supply wires and the input terminals of the inverter with each other.

* With overcurrent protection

- Note**
- When wiring the main circuit power lines of the 230 V class series inverters of 7.5 to 60 HP and 460, be sure to pass them through a ferrite core.
For 575V series, ferrite core is not required.
 - To drive the inverter with single-phase input power, consult your Fuji Electric representative.
- Tip**
- It is recommended to insert a manually operable magnetic contactor (MC) that allows you to disconnect the inverter from the power supply in an emergency (e.g., when the protective function is activated), preventing a failure or accident from causing secondary disasters.
 - When shielded wires are not used for the motor cable, remove the motor cable clamps to prevent the cable covering from getting damaged, which makes the machinery or equipment incompliant with the EMC standards. Wiring the inverter main power input lines without passing them through a ferrite core also makes the machinery or equipment incompliant with the EMC standards due to increase of noise generated by the inverter, but it does not affect inverter basic operation.

⑥ Auxiliary control power input terminals R0 and T0

In general, the inverter runs normally without power supplied to the auxiliary control power input terminals R0 and T0. If the inverter main power is shut down, however, no power is supplied to the control circuit so that the inverter cannot issue a variety of output signals or display on the keypad.

To retain an alarm output signal *ALM* issued on inverter's programmable output terminals by the protective function or to keep the keypad alive even if the main power has shut down, connect the auxiliary control power input terminals R0 and T0 to the power supply lines. If a magnetic contactor (MC) is installed in the inverter's primary circuit, connect the primary circuit of the MC to these terminals R0 and T0.

Terminal rating:

200 to 240 VAC, 50/60 Hz, Maximum current 1.0 A (230 V class series of 25 HP or below)

200 to 230 VAC, 50/60 Hz, Maximum current 1.0 A (230 V class series of 30 HP or above)

380 to 480 VAC, 50/60 Hz, Maximum current 0.5 A (460 V class series)

575 to 600 VAC, 50/60 Hz, Maximum current 0.5 A (575 V class series)

- Note**
- When introducing a residual-current-operated protective device (RCD)/earth leakage circuit breaker (ELCB), connect its output (secondary) side to terminals R0 and T0. Connecting its input (primary) side to those terminals causes the RCD/ELCB to malfunction since the input power voltage to the inverter is three-phase but the one to terminals R0 and T0 is single-phase. To avoid such problems, be sure to insert an insulation transformer or auxiliary B contacts of a magnetic contactor in the location shown in Figure 5.4.

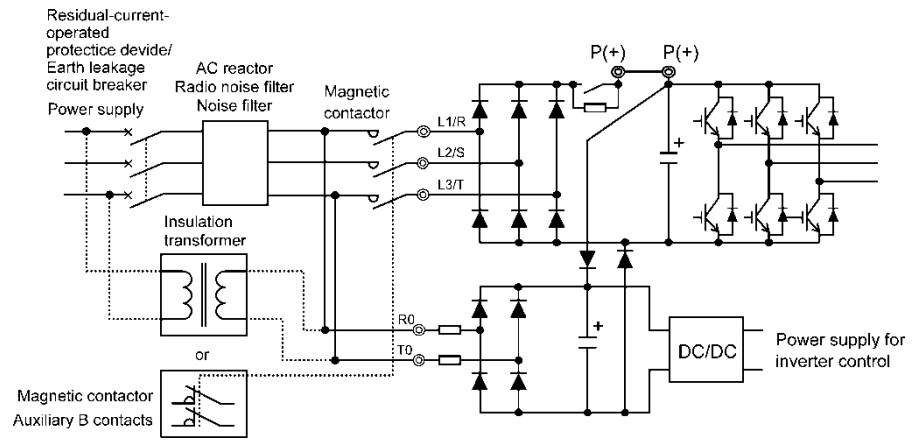

Figure 5.4 Connection Example of residual-current-operated protective device (RCD)/ Earth Leakage Circuit Breaker (ELCB)

⑦ Grounding for EMC filter, E1 and E2

Usually there is no need to do anything for these terminals.

When the leakage current from the connected EMC filter causes problems with the power supply system, removing screws from terminals [E1] and [E2] could improve the problem. Note that doing so loses the effect of the EMC filter so that the inverter is no longer compliant with the EMC standards. To remove those screws, consult your Fuji Electric representative.

⑧ Auxiliary main power input terminals R1 and T1

(on 230 V class series inverters of 30 HP or above and 460/575 V ones of 60 HP or above)

Usually there is no need to do anything for these terminals.

When the inverter works with the DC-linked power input (in combination with a PWM converter), these terminals are used to feed AC power.

Using these terminals require switching the main power switching connectors CN R and CN W.

Terminal rating:

230 V class series: 200 to 220 VAC/60 Hz, 200 to 230 VAC/60 Hz
Maximum current 1.0 A

460 V class series: 380 to 440 VAC/50 Hz, 380 to 480 VAC/60 Hz
800 HP or below: Maximum current 1.0 A
900/1000 HP: Maximum current 2.0 A

575 V class series: 575 to 600 VAC/50Hz, 575 to 600 VAC/60Hz
Maximum current 1.0 A

⑨ Switching connectors

- Power voltage switching connectors (CN UX) (for 460 V class series inverters of 60 HP or above)

The 460 V class series of 60 HP or above is equipped with a set of switching connectors (male) which should be configured according to the power source voltage and frequency. By factory default, a jumper (female connector) is set to U1. If the power supply to the main power inputs (L1/R, L2/S, L3/T) or the auxiliary main power input terminals (R1, T1) matches the conditions listed below, change the jumper to U2.

For the switching instructions, see Figures 5.4-1 to 5.4-4.

(a) 60 to 200 HP

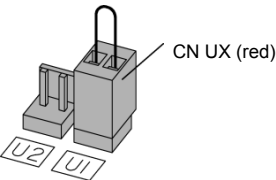
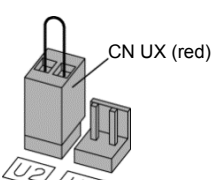
Connector configuration		
Power source voltage	398 to 440 V/50 Hz, 430 to 480 V/60 Hz (Factory default)	380 to 398 V/50 Hz, 380 to 430 V/60 Hz

Note The allowable power input voltage fluctuation is within -15% to +10% of the power source voltage.

(b) 250 to 1000 HP

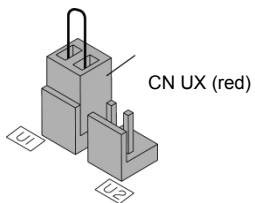
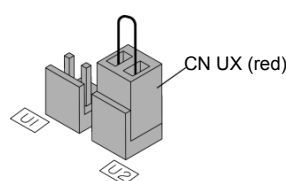
Connector configuration		
Power source voltage	398 to 440 V/50 Hz, 430 to 480 V/60 Hz (Factory default)	380 to 398 V/50 Hz, 380 to 430 V/60 Hz

Note The allowable power input voltage fluctuation is within -15% to +10% of the power source voltage.

- Main power switching connectors (CN R and CN W) (for 230 V class series inverters of 30 HP or above and 460 V ones of 60 HP or above, 575 V ones of 60 HP or above)

The standard FRENIC-HVAC series accepts DC-linked power input. The 230 V class series inverters of 30 HP or above and 460 V/575V ones of 60 HP or above, however, contain AC-driven components. To supply AC power to those components, exchange the CN R and CN W connectors as shown below and connect the AC power line to the auxiliary main power input terminals (R1, T1).

For the switching instructions, see Figures 5.4-1 to 5.4-4.

(a) 230 V class series inverters of 30 HP or above and 460 V ones of 60 to 200 HP and 575V ones of 60 to 150HP

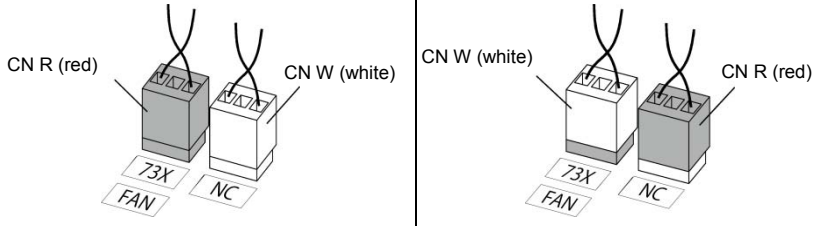
Connector configuration		
Use conditions	When not using terminal R1 or T1 (Factory default)	When using terminals R1 and T1 <ul style="list-style-type: none"> • Feeding the DC-linked power • Combined with a PWM converter

(b) 460 V class series inverters of 250 HP or above and 575V ones of 200 HP or above

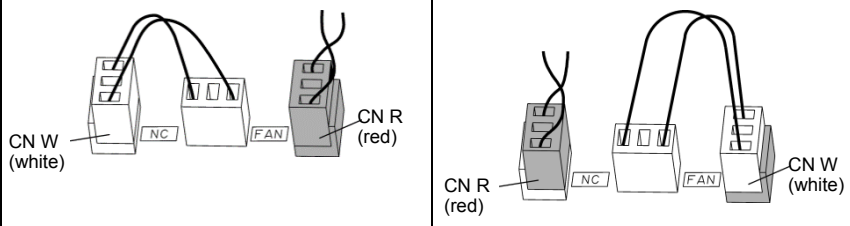
Connector configuration		
Use conditions	When not using terminal R1 or T1 (Factory default)	When using terminals R1 and T1 <ul style="list-style-type: none"> • Feeding the DC-linked power • Combined with a PWM converter

Note By factory default, the CN R is set on the **73X** position (230 V class series inverters of 30 to 60 HP, 460V ones of 60 to 125HP and 575V ones of 60 to 150HP) or on the **FAN** position (230 V class series inverters of 75 HP or above and 460 V ones of 150 HP or above and 575V ones of 200HP or above), and the CN W is set on the **NC** position. Do not exchange them unless you drive the inverter with a DC-linked power supply.

Wrong configuration of these switching connectors causes a heat sink overheat alarm “**CH**” or a charger circuit alarm “**PF**”.

■ Location of the switching connectors

The switching connectors are located on the power printed circuit board (power PCB) as shown below.

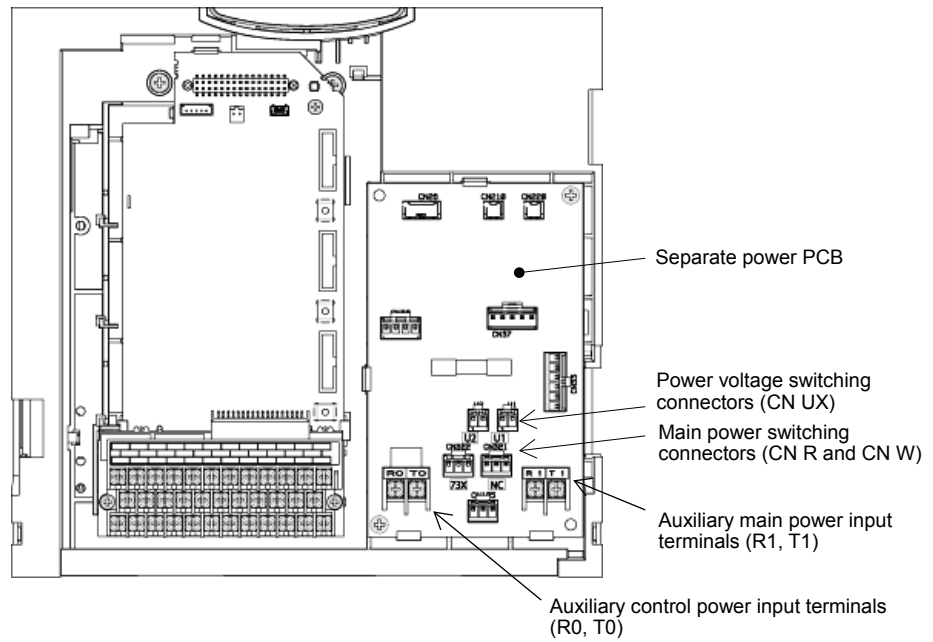

Figure 5.4-1 Location of Switching Connectors
(230 V class series inverters of 30 to 60 HP and 460 V ones of 60 to 125 HP and 575V ones of 60 to 150HP)

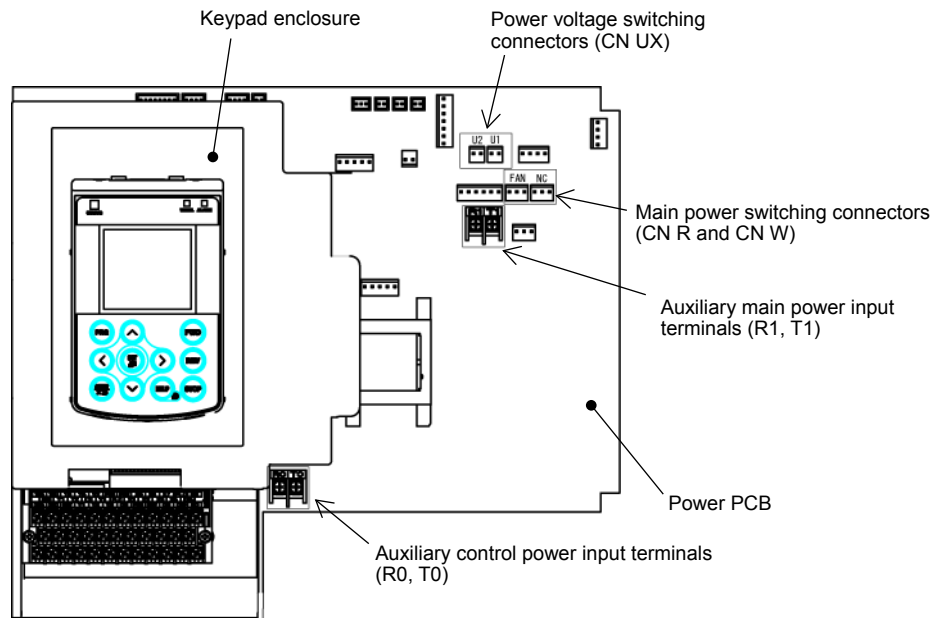

Figure 5.4-2 Location of Switching Connectors
(230 V class series inverters of 75 to 125 HP and 460 V ones of 150 to 200 HP)

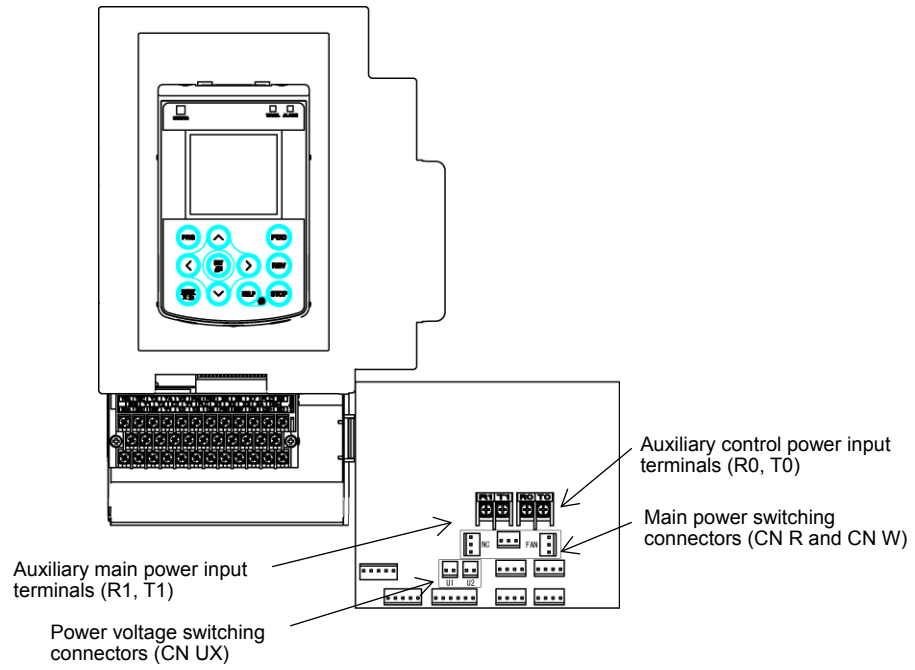

Figure 5.4-3 Location of Switching Connectors
(460 V class series inverters of 250 HP or above and 575V ones of 200 to 300 HP)

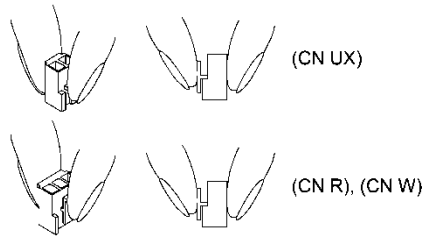



Figure 5.4-4 Removing/Inserting the Jumpers

Note To remove each of the jumpers, pinch its upper side between your fingers, unlock its fastener, and pull it up.
When inserting the jumper, fit it over the connector until its fastener snaps into place.

5.1.7 Wiring for control circuit terminals

 WARNING 
In general, the covers of the control signal wires are not specifically designed to withstand a high voltage (i.e., reinforced insulation is not applied). Therefore, if a control signal wire comes into direct contact with a live conductor of the main circuit, the insulation of the cover might break down, which would expose the signal wire to a high voltage of the main circuit. Make sure that the control signal wires will not come into contact with live conductors of the main circuit.
Failure to observe these precautions could cause electric shock or an accident.



 CAUTION 
Noise may be emitted from the inverter, motor and wires. Take appropriate measures to prevent the nearby sensors and devices from malfunctioning due to such noise.
An accident could occur.

Table 5.2 lists the symbols, names and functions of the control circuit terminals. The wiring to the control circuit terminals differs depending upon the setting of the function codes, which reflects the use of the inverter. Route wires properly to reduce the influence of noise.

Table 5.2 Symbols, Names and Functions of the Control Circuit Terminals

Classification	Symbol	Name	Functions
Analog input	[13]	Power supply for the potentiometer	Power supply (+10 VDC) for frequency command potentiometer (Potentiometer: 1 to 5kΩ)
	[12]	Analog setting voltage input	The frequency is commanded according to the external analog voltage input.
	[C1]	Analog setting current input PTC thermistor input	The frequency is commanded according to the external analog current input. Connects PTC (Positive Temperature Coefficient) thermistor for motor protection.
	[V2]	Analog setting voltage input	The frequency is commanded according to the external analog voltage input.
	[11]	Analog common	Common for analog input/output signals
Digital input	[X1]	Digital input 1	(1) Various signals such as "Coast to a stop," "Enable external alarm trip," and "Select multi-frequency" can be assigned to terminals [X1] to [X7], [FWD] and [REV] by setting function codes E01 to E07, E98, and E99. (2) Input mode, i.e. SINK/SOURCE, is changeable by using the slide switch SW1. (3) The logic value (1/0) for ON/OFF of the terminals [X1] to [X7], [FWD], or [REV] can be switched. If the logic value for ON of the terminal [X1] is "1" in the normal logic system, for example, OFF is "1" in the negative logic system and vice versa.
	[X2]	Digital input 2	
	[X3]	Digital input 3	
	[X4]	Digital input 4	
	[X5]	Digital input 5	
	[X6]	Digital input 6	
	[X7]	Digital input 7	
	[FWD]	Run forward command	Short-circuiting terminals [FWD] and [CM] runs the motor in the forward direction and opening them decelerates the motor to a stop.
	[REV]	Run reverse command	Short-circuiting terminals [REV] and [CM] runs the motor in the reverse direction and opening them decelerates the motor to a stop.

Classification	Symbol	Name	Functions
Digital input	[EN1]	Enable input 1	(1) Opening terminals [EN1] and [PLC] or terminals [EN2] and [PLC] stops the inverter's output transistor. (2) These terminals are exclusively used for the SOURCE mode input and cannot be switched to the SINK mode input. (3) If input to either one of [EN1] and [EN2] is OFF, the inverter issues an alarm (ECF).
	[EN2]	Enable input 2	
	[PLC]	Power for programmable logic controller signals	Connects to PLC output signal power supply.
	[CM]	Digital input common	Two common terminals for digital input signals.
Analog output	[FM1]	Analog monitor	These terminals output monitor signals of analog DC voltage (0 to +10 V) or analog DC current (+4 to +20 mA DC or 0 to +20 mA DC).
	[FM2]		
	[I1]	Analog common	Two common terminals for analog input and output signals.
Transistor output	[Y1]	Transistor output 1	Both the SINK and SOURCE modes are supported. (1) Various signals such as inverter running, frequency arrival and overload early warning can be assigned to terminals [Y1] to [Y4] by setting function code E20 to E23. (2) It is possible to switch the logic value (1/0) for ON/OFF of the terminals between [Y1] to [Y4], and [CMY]. If the logic value for ON between [Y1] to [Y4] and [CMY] is 1 in the normal logic system, for example, OFF is 1 in the negative logic system and vice versa.
	[Y2]	Transistor output 2	
	[Y3]	Transistor output 3	
	[Y4]	Transistor output 4	
	[CMY]	Transistor output common	Common terminal for transistor output signals
Relay output	[Y5A/C]	General-purpose relay output	(1) A general-purpose relay contact output usable as well as the function of the transistor output terminal [Y1], [Y2], [Y3] or [Y4]. (2) Whether excitation or non-excitation causes this terminal to output an alarm can be switched.
	[30A/B/C]	Alarm relay output	(1) Outputs a contact signal (1C) when the protective function has been activated to stop the motor. (2) Any one of output signals assigned to terminals [Y1] to [Y4] can also be assigned to this relay contact to use it for signal output. (3) Whether excitation or non-excitation causes this terminal to output an alarm can be switched.
Communication	DX+/DX-/SD	RS-485 communications port 2 (Terminal block)	The communications port transmits data through the RS-485 multipoint protocol between the inverter and a computer or other equipment such as a PLC (Programmable Logic Controller).
	RJ-45 connector for the keypad	RS-485 communications port 1 (Standard RJ-45 connector)	Used to connect the inverter with the keypad. The inverter supplies the power to the keypad through the pins specified below. The extension cable for remote operation also uses wires connected to these pins for supplying the keypad power.

Classification	Symbol	Name	Functions
Communication	CN10	USB port	Used as a USB port connector (mini B) that connects the inverter to a computer. This connector enables connection with the inverter support loader (FRENIC-HVAC Loader).
Battery	CN11	Connector for battery	A connector for an optional battery. For details, refer to Section 4.5 "Battery."

- Note**
- Route the wiring of the control circuit terminals as far from the wiring of the main circuit as possible. Otherwise electric noise may cause malfunctions.
 - Fix the control circuit wires with a cable tie inside the inverter to keep them away from the live parts of the main circuit (such as the terminal block of the main circuit).

5.1.8 Setting up the slide switches

⚠ WARNING ⚠

Before changing the switches, turn OFF the power and wait at least ten minutes. Make sure that the LCD monitor is turned OFF. Further, make sure, using a multimeter or a similar instrument, that the DC link bus voltage between the terminals P(+) and N(-) has dropped to the safe level (+25 VDC or below).

An electric shock may occur.

Switching the slide switches located on the control PCB allows you to customize the operation mode of the analog output terminals, digital I/O terminals, and communications ports. The locations of those switches are shown in Figure 5.5.

To access the slide switches, remove the front cover so that you can see the control PCB.

Table 5.3 lists the function of each slide switch.

Table 5.3 Function of Each Slide Switch

Slide Switch	Function																			
SW1	Switches the service mode of the digital input terminals between SINK and SOURCE. - This switches the input mode of digital input terminals [X1] to [X7], [FWD] and [REV] to be used as the SINK or SOURCE mode. - Factory default: SINK																			
SW2	Switches the terminating resistor of RS-485 communications port on the inverter ON and OFF. (RS-485 communications port 2, on the terminal block) - If the inverter is connected to the RS-485 communications network as a terminating device, turn SW2 to ON.																			
SW3	Switches the terminating resistor of RS-485 communications port on the inverter ON and OFF. (RS-485 communications port 1, for connecting the keypad) - To connect a keypad to the inverter, turn SW3 to OFF (Factory default). - If the inverter is connected to the RS-485 communications network as a terminating device, turn SW3 to ON.																			
SW4/SW6	Switches the output mode of the analog output terminal [FM1]/[FM2] between voltage and current. When changing this switch setting, also change the data of function code F29/F32. <table border="1" style="margin-left: 20px;"> <thead> <tr> <th rowspan="2">Output mode</th> <th colspan="2">[FM1]</th> <th colspan="2">[FM2]</th> </tr> <tr> <th>SW4</th> <th>F29 data</th> <th>SW6</th> <th>F32 data</th> </tr> </thead> <tbody> <tr> <td>Voltage output (Factory default)</td> <td>VO1</td> <td>0</td> <td>VO2</td> <td>0</td> </tr> <tr> <td>Current output</td> <td>IO1</td> <td>1, 2</td> <td>IO2</td> <td>1, 2</td> </tr> </tbody> </table>	Output mode	[FM1]		[FM2]		SW4	F29 data	SW6	F32 data	Voltage output (Factory default)	VO1	0	VO2	0	Current output	IO1	1, 2	IO2	1, 2
Output mode	[FM1]		[FM2]																	
	SW4	F29 data	SW6	F32 data																
Voltage output (Factory default)	VO1	0	VO2	0																
Current output	IO1	1, 2	IO2	1, 2																
SW5	Switches the property of the analog input terminal [C1] between analog setting current input and PTC thermistor input. When changing this switch setting, also change the data of function code H26. <table border="1" style="margin-left: 20px;"> <thead> <tr> <th>Output mode</th> <th>SW5</th> <th>H26 data</th> </tr> </thead> <tbody> <tr> <td>Analog setting current input (Factory default)</td> <td>C1</td> <td>0</td> </tr> <tr> <td>PTC thermistor input</td> <td>PTC</td> <td>1 (alarm) or 2 (warning)</td> </tr> </tbody> </table>	Output mode	SW5	H26 data	Analog setting current input (Factory default)	C1	0	PTC thermistor input	PTC	1 (alarm) or 2 (warning)										
Output mode	SW5	H26 data																		
Analog setting current input (Factory default)	C1	0																		
PTC thermistor input	PTC	1 (alarm) or 2 (warning)																		

Figure 5.5 shows the location of slide switches on the control PCB.

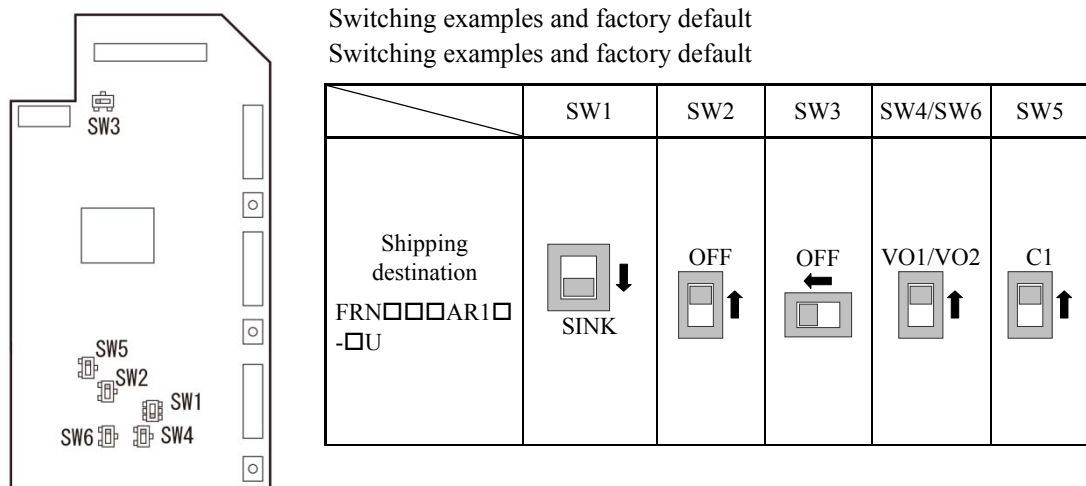

Figure 5.5 Location of the Slide Switches on the Control PCB

Note To move a switch slider, use a tool with a narrow tip (e.g., tweezers), taking care not to touch other electronic parts on the PCB. If the slider is in an ambiguous position, the circuit is unclear whether it is turned ON or OFF and the input remains in an undefined state. Be sure to place the slider so that it contacts either side of the switch.

Slider in the correct position	or
Slider in an ambiguous position	

5.1.9 USB port

⚠ WARNING ⚠

To connect a USB cable, turn OFF the power and wait at least ten minutes. Make sure that the LCD monitor is turned OFF. Further, make sure, using a multimeter or a similar instrument, that the DC link bus voltage between the terminals P(+) and N(-) has dropped to the safe level (+25 VDC or below).

An electric shock may occur.

The USB port* (CN10) is located in the upper right corner of the control printed circuit board (control PCB). To connect the USB cable to the port, remove the front cover so that you can see the control PCB.

Connecting the inverter to a PC with a USB cable enables remote control from FRENIC-HVAC Loader. On the PC running FRENIC- HVAC Loader, it is possible to edit, check and manage the inverter's function code data and monitor the running/alarm status of the inverter.

* mini B, compliant with Ver. 2.0

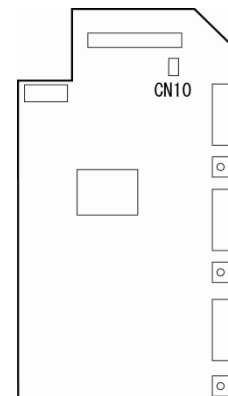

Figure 5.6 USB Connector Position on Control PCB

5.2 Mounting and Connecting a Keypad

5.2.1 Parts required for connection

To mount/install a keypad on a place other than in an inverter, the parts listed below are needed.

Parts name	Model	Remarks
Extension cable (Note 1)	CB-5S, CB-3S and CB-1S	3 types available in length of 5m (16 ft), 3 m (9.8 ft), and 1 m (3.3 ft).
Fixing screw	M3 × □ (Note 2)	Two screws needed. Purchase off-the-shelf ones separately.

(Note 1) When using an off-the-shelf LAN cable, use a 10BASE-T/100BASE-TX straight type cable compliant with US ANSI/TIA/EIA-568A Category 5. (Less than 20m (66 ft))

Recommended LAN cable

Manufacturer: Sanwa Supply Inc.

Model: KB-10T5-01K (1 m (3.3 ft))

KB-STP-01K: (1 m (3.3 ft)) (Shielded LAN cable to make the inverter compliant with the EMC Directive)

(Note 2) Use the screws with a length suitable for the wall thickness.

5.2.2 Mounting procedure

After completion of wiring, remove the keypad from the inverter and mount it to the panel using the following procedure. Make sure that the inverter power is shut down beforehand.

- (1) Remove the front cover, then remove the keypad by pulling it toward you with the hook held down as directed by the arrows shown below.

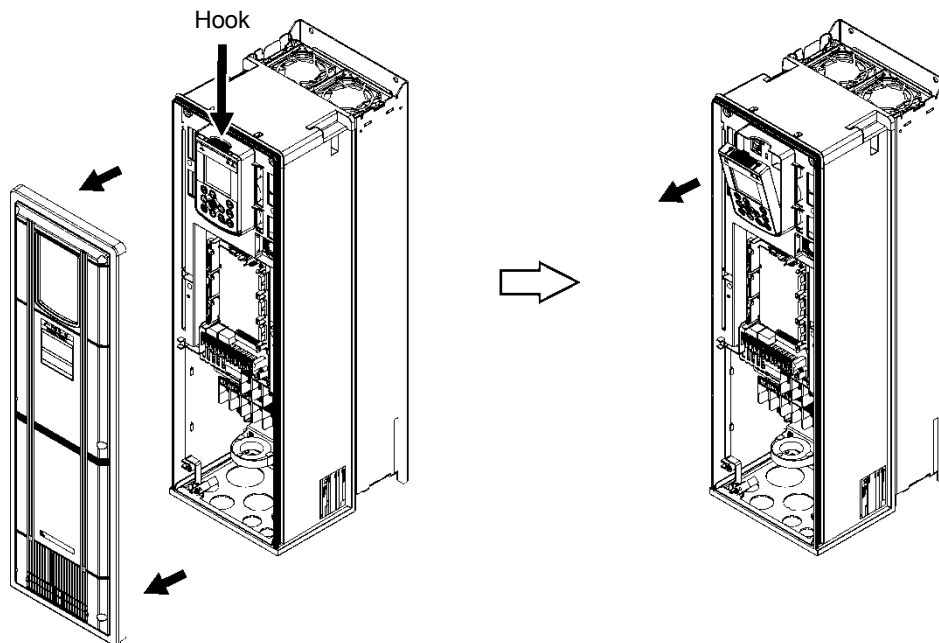



Figure 5.7 Removing the Keypad

 For the front cover removal procedure, refer to Section 5.1.2.1 "Removing and mounting the front cover and the wiring plate."

- (2) Cut the panel out for a single square area and perforate two screw holes on the panel wall as shown in Figure 5.8.

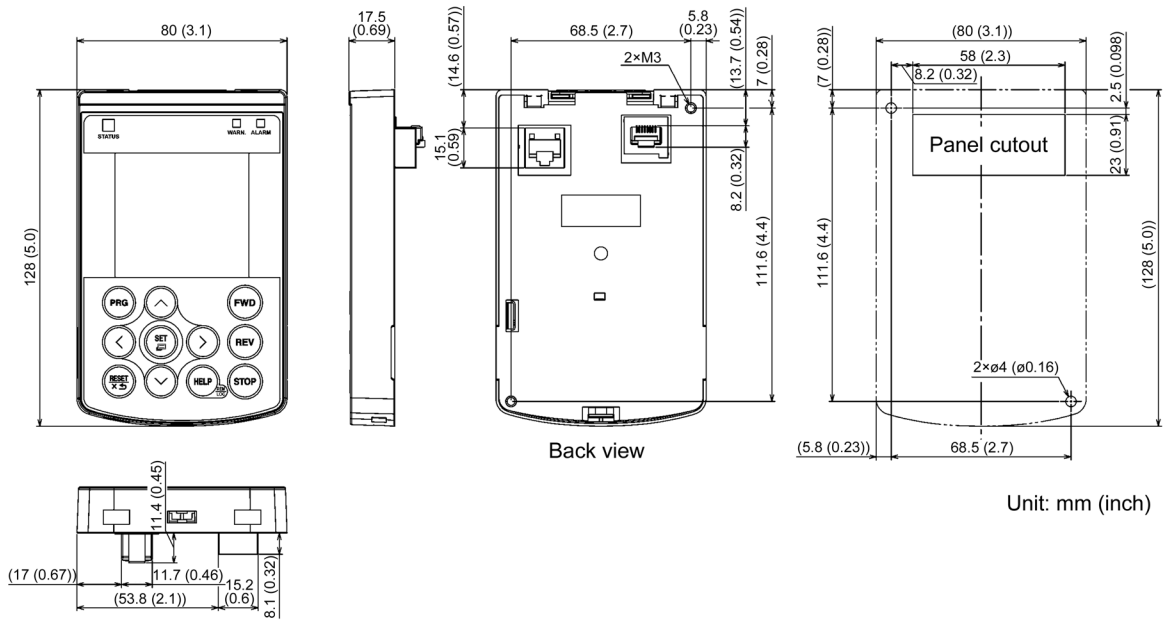

Figure 5.8 Location of Screw Holes and Dimension of Panel Cutout

- (3) Mount the keypad on the panel wall with 2 screws as shown below. (Recommended tightening torque: 0.7 N•m(6.2 lb-in))

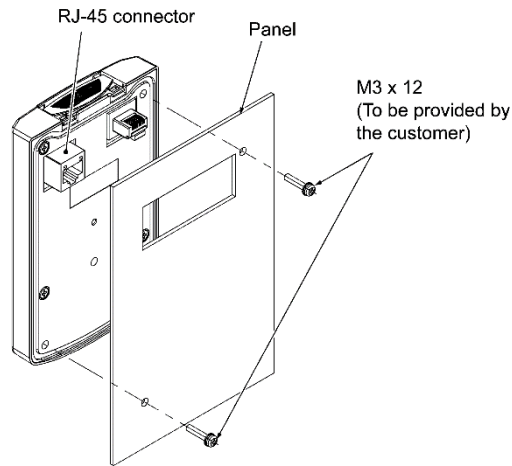

Figure 5.9 Mounting the Keypad

- (4) Using a remote operation extension cable or a LAN cable, interconnect the keypad and the inverter (insert one end of the cable into the RS-485 port with RJ-45 connector on the keypad and the other end into that on the inverter) (See Figure 5.10).

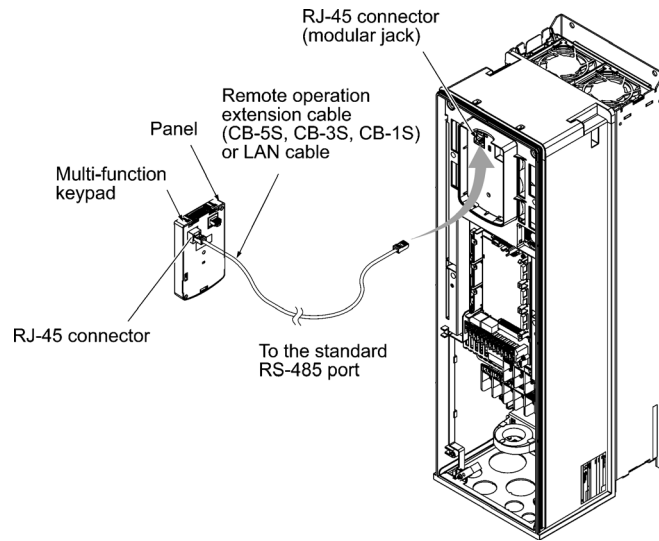

Figure 5.10 Connecting the Keypad to the Inverter with Remote Operation Extension Cable or an Off-the-shelf LAN Cable

- (5) Be sure to put the front cover back into place before using the inverter.

Note After the keypad is removed, the enclosure rating of the inverter unit is UL open type.

5.3 Operation Using the Keypad

5.3.1 LCD monitor, keys and LED indicators on the keypad

The keypad allows you to run and stop the motor, monitor the running status, specify the function code data, and monitor I/O signal states, maintenance information, and alarm information.

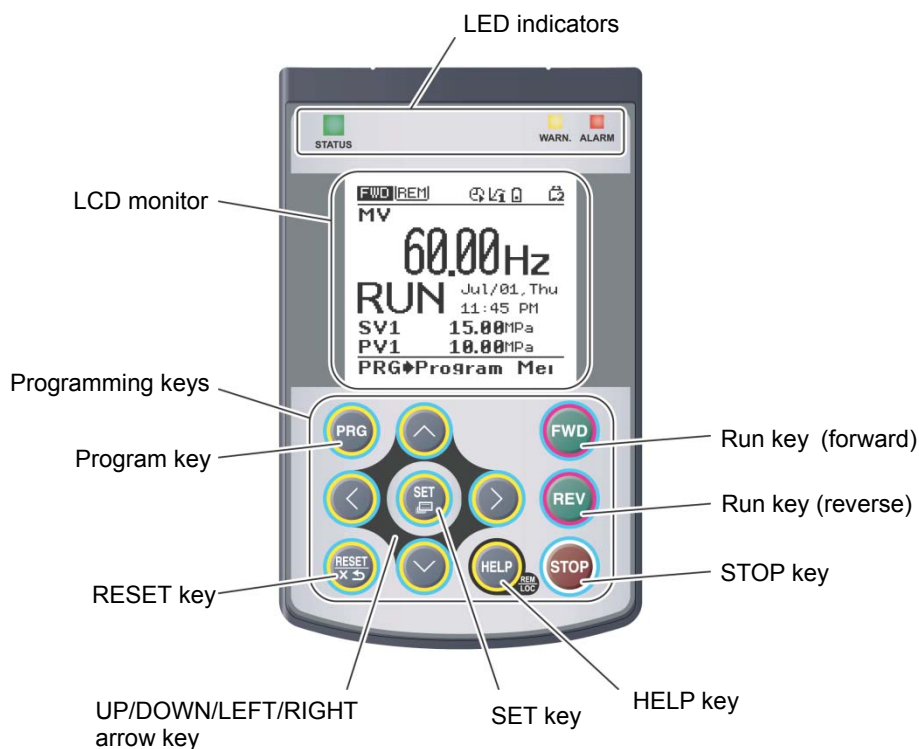

Figure 5.11 Names and Functions of Keypad Components

1. LED indicators:	These indicators show the current running status of the inverter.	Refer to Table 5.4.
2. LCD monitor:	This monitor shows the following various information about the inverter according to the operation modes.	Refer to Figure 5.12 and Table 5.6.
3. Keys:	These keys are used to perform various inverter operations.	Refer to Table 5.5.

Table 5.4 Indication of LED Indicators













LED Indicators	Indication	
 STATUS (Green)	Shows the inverter running state.	
	Flashing	No run command input (Inverter stopped)
	ON	Run command input
 WARN. (Yellow)	Shows the light alarm state.	
	OFF	No light alarm has occurred.
	Flashing /ON	A light alarm has occurred.
 ALARM (Red)	Shows the alarm state (heavy alarm).	
	OFF	No heavy alarm has occurred.
	Flashing	A heavy alarm has occurred.

Table 5.5 Overview of Keypad Functions

Number	Keys	Functions
3-1		This key switches the operation modes between Running mode/Alarm mode and Programming mode.
3-2		Reset key which works as follows according to the operation modes. ■ In Running mode: This key cancels the screen transition. ■ In Programming mode: This key resets the alarm states and switches to Programming mode. ■ In Alarm mode: This key discards the settings being configured and cancels the screen transition.
3-3		UP/DOWN key which works as follows according to the operation modes. ■ In Running mode: These keys switch to the digital reference frequency and PID command modification screen (when commands from the keypad are enabled). ■ In Programming mode: These keys display multiple alarms and alarm history. ■ In Alarm mode: These keys select menu items, change data, and scroll the screen.
		These keys move the cursor to the digit of data to be modified, shift the setting item, and switch the screen.
3-4		Set key which works as follows according to the operation modes. ■ In Running mode: Pressing this key switches to the selection screen of the LCD monitor content. ■ In Programming mode: Pressing this key switches to the alarm detailed information screen. ■ In Alarm mode: Pressing this key established the selected items and data being changed.
3-5		Pressing this key calls up the HELP screen according to the current display state. Holding it down for 2 seconds toggles between the remote and local modes.
3-6		Pressing this key starts running the motor in the forward rotation (when a run command from the keypad is enabled).
3-7		Pressing this key starts running the motor in the reverse rotation (when a run command from the keypad is enabled).
3-8		Pressing this key stops the motor (when a run command from the keypad is enabled or the STOP key priority is selected).

■ LCD monitor

The LCD monitor shows various information of the inverter according to the operation modes.

< Screen sample in Running mode >

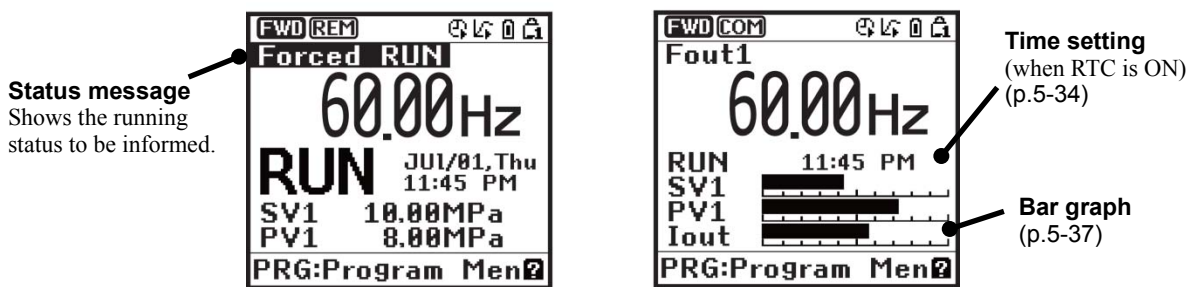
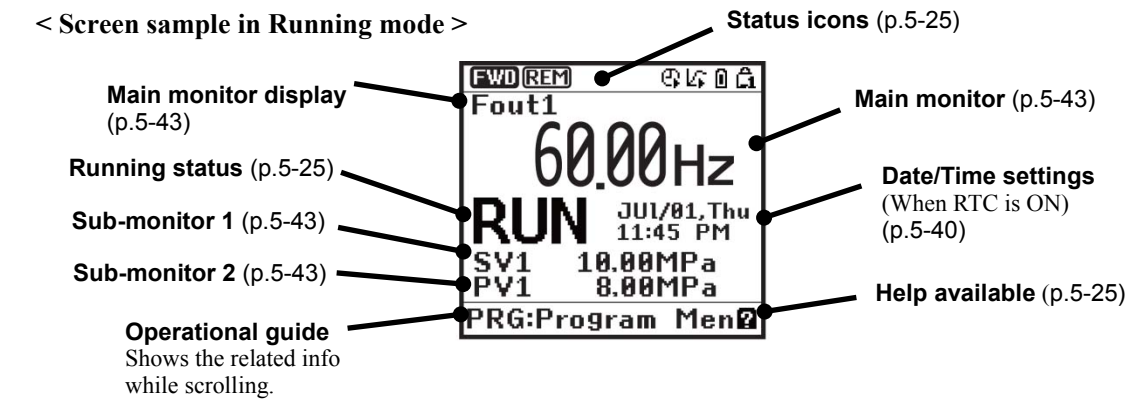

< Screen sample in Alarm mode >

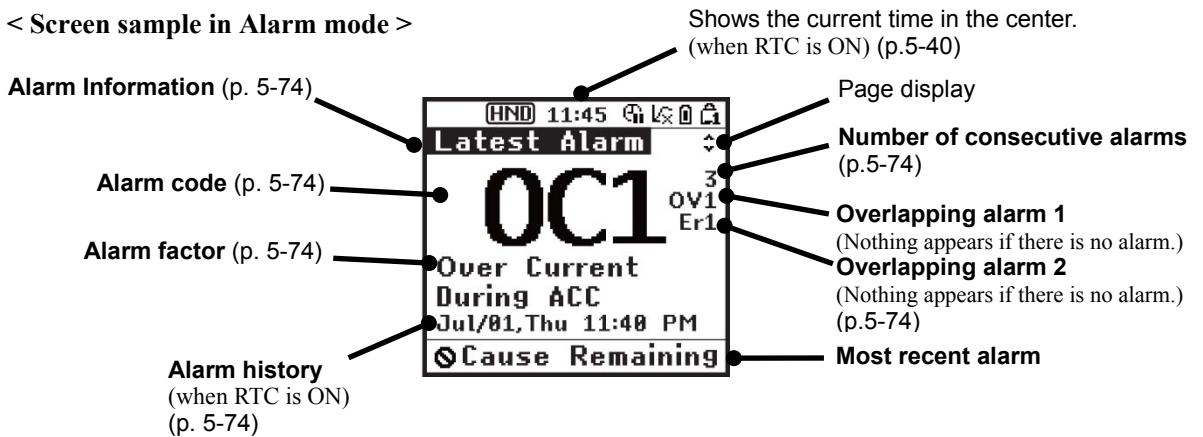

Figure 5.12 Screen Samples In Running and Alarm Modes

Table 5.6 Icons on the LCD Monitor

Status icons that show the running status, run command sources and various icons		
	Running status (rotation direction)	Running forward
		Running reverse
	Run command source	Keypad
		External terminals
		Keypad in local mode
		Communications link
	Timer operation	Running under timer control (Timer enabled and run command entered)
		<ul style="list-style-type: none"> Stopped under timer control (Timer enabled and run command entered) PID control being canceled (during running or stop) Pause date (during running or stop)
		Timer enabled, real-time clock normal, no run command entered (except during canceling)
		Timer operation specified and real-time clock info lost (running prohibited) All of terminals [TM1] to [TM4] are OFF (running prohibited)
	PID operation (Internal PID)	Internal PID configured and PID1 being selected (This icon appears even a run command is OFF.)
		Internal PID configured and PID2 being selected (This icon appears even a run command is OFF.)
		PID operation stopped temporarily, e.g., due to slow flowrate (Run command being ON)
		PID operation canceled (including boost)
	Battery state	Battery connected and sufficiently charged.
		Battery not connected or low battery charge
	Password protection state	Inverter being locked (Force to stop, Inoperable)
		Locked with password 2 (Access to function codes is prohibited.)
		Locked with password 1 (Function code data change is prohibited.)
		Lock being released (Password being canceled)
Running status		
	Running status	No run command entered or inverter stopped
		Run command entered or during inverter output
HELP that displays help information corresponding to the current screen		
		Help available
	(flashing)	Help being displayed

Note LCDs have temperature characteristics. The low temperature slows down the LCD response; the high temperature makes the screen contrast high so that contrast adjustment may be needed.

5.4 Overview of Operation Modes

FRENIC-HVAC features the following three operation modes:

- **Running mode** : After powered ON, the inverter automatically enters this mode.
This mode allows you to specify the reference frequency, PID command value and etc., and run/stop the motor with the (FWD) / (REV) / (STOP) keys.
It is also possible to monitor the running status in real time.
- **Programming mode** : This mode allows you to configure function code data and check a variety of information relating to the inverter status and maintenance.
- **Alarm mode** : If an alarm condition arises, the inverter automatically enters Alarm mode. In this mode, you can view the corresponding alarm code* and its related information on the LCD monitor.

* Alarm code: Indicates the cause of the alarm condition. For details, refer to Chapter 9, Section 9.1 "Protective Functions" and Section 5.6.5 "Reading alarm information" in this chapter.

Figure 5.13 shows the status transition of the inverter between these three operation modes. If the inverter is turned ON, it automatically enters Running mode, making it possible to start or stop the motor.

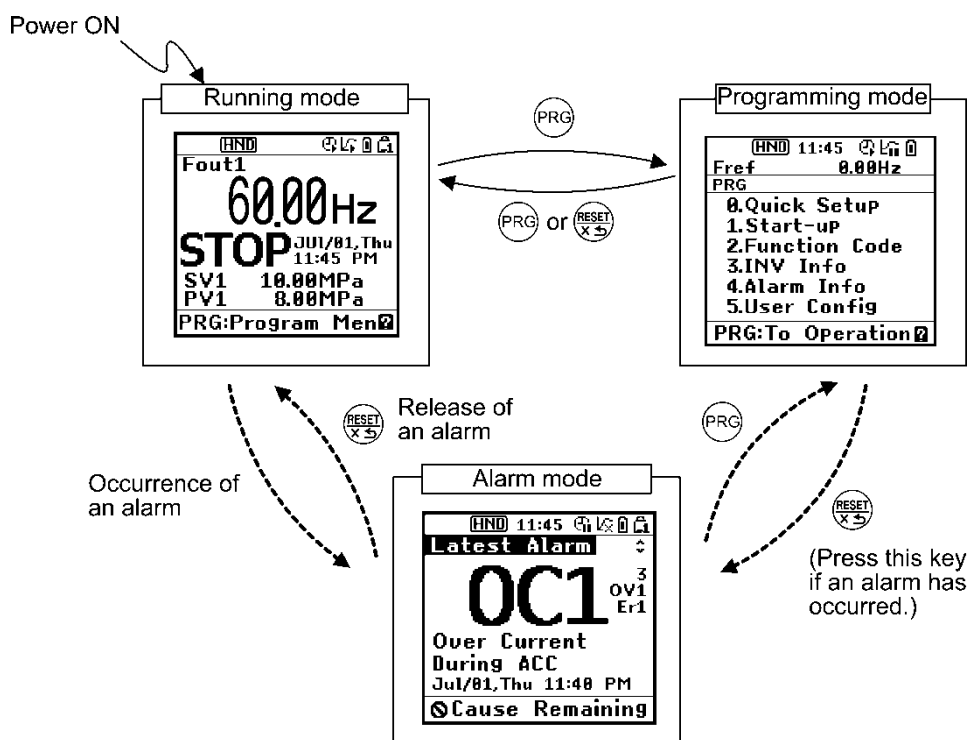

Figure 5.13 Status Transition between Operation Modes

5.5 Running Mode

When the inverter is turned on, it automatically enters Running mode in which you can:

- (1) Monitor the running status (e.g., output frequency and output current),
- (2) Configure the reference frequency and PID commands, etc.,
- (3) Run/stop the motor,
- (4) Switch between remote and local modes
- (5) Switch the operation from the keypad to the one by external signals (terminal block), and
- (6) Monitor light alarms

5.5.1 Monitoring the running status

In Running mode, the nine items listed below can be monitored. Immediately after the inverter is turned on, the monitor item specified by function code K10 is displayed. Press the  key to switch between monitor items.



Table 5.7 Monitoring Items (Selectable anytime)

Monitor names	Sub-monitor	Unit	Meaning of displayed value	Function code data for K10
Speed monitor	Function code K11 specifies what to be displayed on the main monitor.			0
Output frequency 1 (before slip compensation)	Fout1	Hz	Frequency actually being output	(K11 = 1)
Output frequency 2 (after slip compensation)	Fout2	Hz	Frequency actually being output	(K11 = 2)
Reference frequency	Fref	Hz	Reference frequency being set	(K11 = 3)
Motor speed	Sync	r/min	Output frequency (Hz) $\times \frac{120}{P01}$	(K11 = 4)
Load shaft speed	Load	r/min	Output frequency (Hz) \times K30	(K11 = 5)
Speed (%)	SPD	%	$\frac{\text{Output frequency}}{\text{Maximum frequency}} \times 100$	(K11 = 8)
Output current	Iout	A	Current output from the inverter in RMS	13
Output voltage	Vout	V	Voltage output from the inverter in RMS	14
Calculated torque	TRQ	%	Motor output torque in % (Calculated value)	18
Input power	PWR	kW	Input power to the inverter	19
Load factor	LOF	%	Load factor of the motor in % as the rated output being at 100%	25
Motor output	MPW	kW	Motor output in kW	26
Analog input monitor (Note 1)	AMon	Unit specified for each terminal	An analog input to the inverter in a format suitable for a desired scale. Refer to function codes below. Terminal [I2]: C59, C60 Terminal [C1]: C65, C66 Terminal [V2]: C71, C72	27
Input watt-hour	Wh	–	$\frac{\text{Input watt-hour (kWh)}}{100}$ Refer to function code K31 for details.	35

The following monitor items appear only when the related PID control or external PID control is enabled. Items for the PID control and external PID control being disabled cannot be displayed.

Table 5.8 Monitoring Items (Selectable when PID control or external PID control is enabled)

Monitor names	Sub-monitor	Unit	Meaning of displayed value	Function code data for K10
PID command (Note 2)	SV	J105 J205	PID command and its feedback converted into physical quantities of the object to be controlled. The display unit can be selected with Function code J105 and J205.	50
PID feedback amount (Note 2)	PV	–		51
PID output (Note 2)	MV	%	PID output in %, assuming the maximum frequency (F01) as 100%	52
PID control 1 command (Note 3)	SV1	–	PID control 1 command and its feedback converted into physical quantities of the object to be controlled. The display unit can be selected with Function code J105.	53
PID control 1 feedback amount (Note 3)	PV1	–		54
PID control 2 command (Note 3)	SV2	–	PID control 2 command and its feedback converted into physical quantities of the object to be controlled. The display unit can be selected with Function code J205.	55
PID control 2 feedback amount (Note 3)	PV2	–		56
External PID control 1 command value (Note 4)	E. SVF	–		60
External PID control 1 feedback amount (Note 4)	E. PVF	–		61
External PID control 1 output (Note 4)	E. MV1	–	PID output in %, assuming the maximum frequency (F01) as 100% The display unit can be selected with Function code J505.	62
External PID control 1 manual command (Note 5)	E. MU1	%		63
External PID control 1 command (Note 6)	E. SV1	%		64
External PID control 1 feedback amount (Note 6)	E. PV1	–	The display unit can be selected with Function code J505.	65
External PID control 2 command (Note 7)	E. SV2	%		70
External PID control 2 feedback amount (Note 7)	E. PV2	–	The display unit can be selected with Function code J605.	71
External PID control 2 output (Note 7)	E. MV2	–	The display unit can be selected with Function code J605.	72
External PID control 2 manual command (Note 8)	E. MU2	%		73
External PID control 3 command (Note 9)	E. SV3	%		80
External PID control 3 feedback amount (Note 9)	E. PV3	–	The display unit can be selected with Function code J655.	81
External PID control 3 output (Note 9)	E. MV3	–	The display unit can be selected with Function code J655.	82
External PID control 3 manual command (Note 10)	E. MU3	%		83

- (Note 1) The analog input monitor appears only when it is assigned to terminal [12], [C1] or [V2] with any of E61 to E63 (data = 20). Specify the display unit with C58, C64 or C70.
- (Note 2) These items appear when J101 (PID control 1) or J201 (PID control 2) $\neq 0$. The  or  appears on the status icon field, indicating that the internal PID is selected.
- (Note 3) These items appear when:
- J101 (PID control 1) or J201 (PID control 2) $\neq 0$
- J101 (PID control 1) or J104 (PID control 1) $\neq 0$
- (Note 4) These items appear when J501 (External PID control 1) $\neq 0$.
- (Note 5) These items appear when J501 (External PID control 1) $\neq 0$ and *%EPID1* ("Cancel external PID control 1") is assigned to any digital input terminal.
- (Note 6) These items appear when J501 or J504 (External PID control 1) $\neq 0$.
- (Note 7) These items appear when J601 (External PID control 2) $\neq 0$.
- (Note 8) This item appears when J601 (External PID control 1) $\neq 0$ and *%EPID2* ("Cancel external PID control 2") is assigned to any digital input terminal.
- (Note 9) These items appear when J651 (External PID control 3) $\neq 0$.
- (Note 10) This item appears when J651 (External PID control 3) $\neq 0$ and *%EPID3* ("Cancel external PID control 3") is assigned to any digital input terminal.

5.5.2 Setting up frequency and PID commands

You can set up the desired frequency and PID commands by using \triangleleft and \triangleright keys on the keypad. It is also possible to set up the frequency command as load shaft speed, motor speed or speed (%) by setting function code K11.

■ Setting up a frequency command

Using the keypad (F01 = 0 (factory default) or 8)

- (1) Set function code F01 to "0" or "8" (\triangleleft / \triangleright keys on keypad). This can be done only when the inverter is in Running mode.
- (2) Press the \triangleleft / \triangleright key to display the current reference frequency. The lowest digit will blink.
- (3) To change the reference frequency, press the \triangleleft / \triangleright key again. The new setting can be saved into the inverter's internal memory.

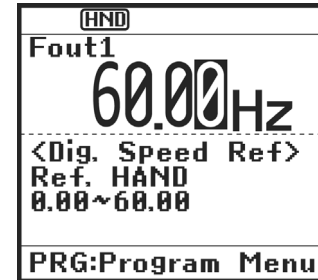

Figure 5.14 Setting up Frequency (display sample)

- Tip**
- The reference frequency will be saved either automatically by turning the main power OFF or only by pressing the STOP key. You can choose either way using function code E64.
 - When you start specifying the reference frequency or any other parameter with the \triangleleft / \triangleright key, the least significant digit on the display blinks; that is, the cursor lies in the least significant digit. Holding down the \triangleleft / \triangleright key changes data in the least significant digit and generates a carry, while the cursor remains in the least significant digit.
Using the \triangleleft / \triangleright key moves the cursor (blinking) between digits, making change to the large value easily.
 - Setting F01 data to "8" (\triangleleft / \triangleright keys on keypad) enables the balanceless-bumpless switching. When the frequency command source is switched to the keypad from any other source, the inverter inherits the current frequency that has applied before switching, providing smooth switching and shockless running.

Using analog input (F01 = 1 to 3, or 5)

- Applying the gain and bias to analog inputs (voltage inputs to terminals [12] and [V2], and current input to terminal [C1]) enables the frequency to be set within an arbitrary range (frequency vs. analog input level).
(Refer to the description of F18, C32, C37, C42, C61, C67.)
- Noise reduction filters are applicable to these analog inputs.
(Refer to the descriptions of C33, C38 and C43.)
- The normal/inverse operation for the frequency command 1 setting (F01) can be selected with function code C53 and be switched between them with the terminal command IVS assigned to any of the digital input terminals.
(Refer to the descriptions of E01 through E07.)

- Note**
- To input bipolar analog voltage (0 to ± 10 VDC) to terminals [12] and [V2], set C35 and C45 data to "0." Setting C35 and C45 data to "1" enables the voltage range from 0 to +10 VDC and interprets the negative polarity input from 0 to -10 VDC as 0 V.
 - A reference frequency can be specified not only with the frequency (Hz) but also with other menu items, depending on the setting of function code K11 (= 4, 5, or 8).

■ Settings under PID process control

To enable the PID process control, you need to set the J101 data (PID control 1) or J201 data (PID control 2) to "1" or "2."

The main monitor can be selected with the $\left(\frac{F01}{\text{PID}}$) key. The items that can be specified or checked with $\left(\wedge\right)$ and $\left(\vee\right)$ keys are switchable between PID process commands under PID monitoring and manual speed commands under any other monitoring.

Setting the PID process command with $\left(\wedge\right)$ and $\left(\vee\right)$ keys

- (1) Set function code J102 to "0" ($\left(\wedge\right)$ / $\left(\vee\right)$ keys on keypad).
- (2) Set the LCD monitor to something other than the speed monitor (K10=0) when the inverter is in Running mode. When the keypad is in Programming or Alarm mode, you cannot modify the PID process command with the $\left(\wedge\right)$ / $\left(\vee\right)$ key. To enable the PID process command to be modified with the $\left(\wedge\right)$ / $\left(\vee\right)$ key, first switch to Running mode.
- (3) Press the $\left(\wedge\right)$ / $\left(\vee\right)$ key to display the PID process command. The lowest digit and its decimal point blink on the LCD monitor.

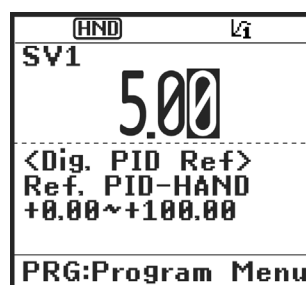

Figure 5.15 Setting the PID Process Command (display sample)

- (4) To change the PID process command, press the $\left(\wedge\right)$ / $\left(\vee\right)$ key again. The new setting can be saved into the inverter's internal memory.



- The PID process command will be saved either automatically by turning the main power OFF or only by pressing the key. You can choose either way using function code E64.
- Even if a PID multistep command is selected (*PID-SS1* or *PID-SS2* = ON) as a PID command, it is possible to set a PID command using the keypad.
- When function code J102 is set to any value other than "0," pressing the / key displays, on the LCD monitor, the PID command currently selected, while you cannot change the setting.

The LCD monitor shows the guidance as shown below.

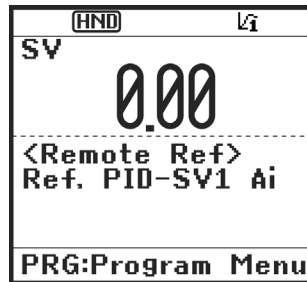

Table 5.9 PID Process Command Manually Set with / Key and Requirements

PID control (Mode selection) J101	PID control (Remote command SV) J102	LCD monitor K10	PID multistep command <i>PID-SS1, PID-SS2</i>	With / key
1 or 2	0	Other than 0	ON or OFF	PID process command <u>by keypad</u>
	Other than 0			PID process command <u>currently selected</u>

Setting up the frequency command with and keys under PID process control

When function code F01 is set to "0" (/ keys on keypad) and frequency command 1 is selected as a manual speed command (when disabling the frequency setting command via the communications link, multistep frequency command, and PID control), switching the LCD monitor to monitoring except PID monitoring in Running mode enables you to modify the frequency command with the / keys.

In Programming or Alarm mode, the / keys are disabled to modify the frequency command. You need to switch to Running mode.

Table 5.10 lists the combinations of the commands and the figure illustrates how the manual speed command [Ⓢ] entered via the keypad is translated to the final frequency command [Ⓢ].

The setting procedure is the same as that for setting of a usual frequency command.

Table 5.10 Manual Speed (Frequency) Command Specified with \wedge / \vee Keys and Requirements

PID control (Mode selection) J101, J102	LCD monitor K10	Frequency command 1 F01	Multi-frequency <i>SS1, SS2</i>	Communications link operation <i>LE</i>	Fire mode <i>FMS</i>	Cancel PID control <i>Hz/PID</i>	Pressing \wedge / \vee keys controls:	
1 or 2	0	0	OFF	OFF	OFF	OFF (PID enabled)	PID output (as final frequency command)	
						ON (PID disabled)	Manual speed (frequency) command set by keypad	
		Other than the above					OFF (PID enabled)	PID output (as final frequency command)
							ON (PID disabled)	Manual speed (frequency) command currently selected

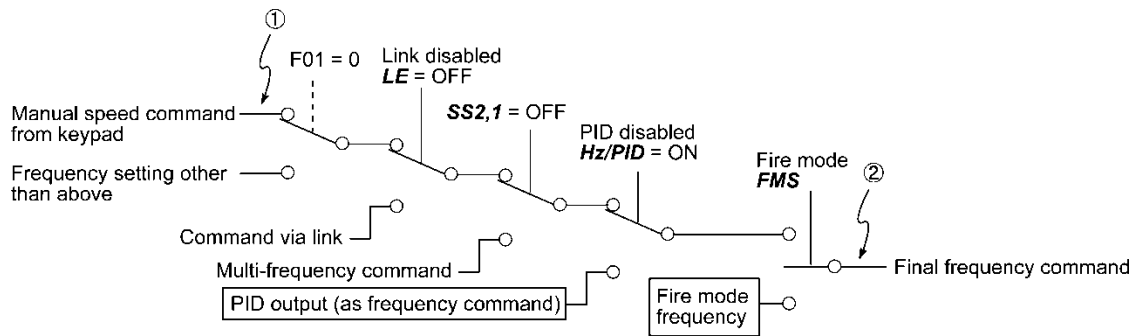

5.5.3 Running/stopping the motor

By factory default, pressing the **FWD** / **REV** key starts running the motor in the forward or reverse direction and pressing the **STOP** key decelerates the motor to stop. The **FWD** / **REV** key is enabled only in Running mode.

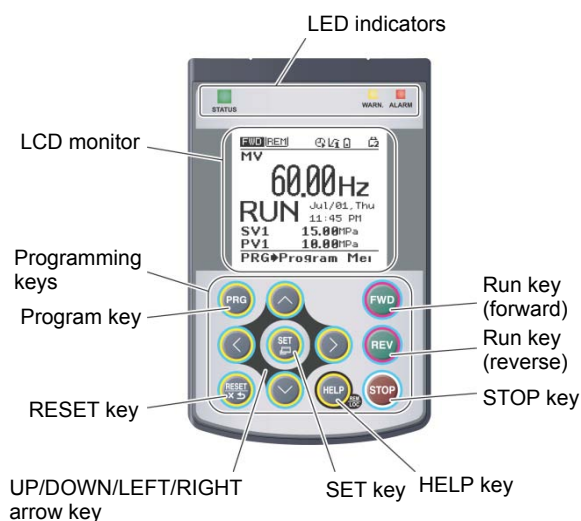

■ Operational relationship between function code F02 (Operation method) and **FWD** / **REV** key

Table 5.11 lists the relationship between function code F02 settings and the **FWD** / **REV** key, which determines the motor rotation direction.

Table 5.11 Motor Rotation Direction Specified by F02

Data for F02	Pressing FWD / REV runs the motor:
0	In the direction commanded by [FWD] or [REV].
1	FWD / REV keys disabled (The motor is driven by [FWD] or [REV].)
2	In the forward direction.
3	In the reverse direction.

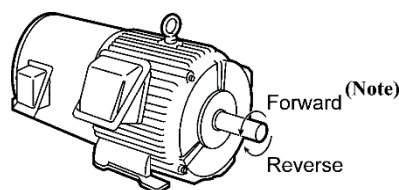

(Note) The rotational direction of IEC-compliant motors is opposite to that of the motor shown here.

For the details on operations with function code F02, refer to Chapter 6 "FUNCTION CODES."

5.5.4 Remote and local modes

The inverter is available in either remote or local mode.

In remote mode, run and frequency commands are selected by function codes. In local mode, the command source is the keypad, regardless of the settings specified by function codes.

Holding down the **HELP** key on the keypad for 2 seconds or more switches between remote and local modes.

Switching these modes is also possible by a digital input signal provided from the outside of the inverter. You need to assign **LOC** (Select local (keypad) operation) as a digital input signal to any of terminals [X1] to [X7].

Refer to E01 through E07.)

Tip The current mode can be checked by the status icons. The **REM** / **COM** is displayed in remote mode and the **LOC**, in local mode.

Switching from remote to local mode automatically inherits the frequency settings used in remote mode. If the motor is running at the time of the switching from remote to local, the run command will be automatically turned ON so that all the necessary data settings will be carried over. If, however, there is a discrepancy between the settings used in remote mode and ones made on the keypad (e.g., switching from the reverse rotation in remote mode to the forward rotation only in local mode), the inverter automatically stops.

5.5.5 Changing from keypad operation to external signal (terminal block) operation

By factory default, both the run commands (FWD / REV / STOP key) and frequency commands are sourced from the keypad. This section provides other external command source samples--an external potentiometer (variable resistor) as a frequency command source and external run switches as run forward/reverse command sources.

Set up those external sources using the following procedure.

- (1) Configure the function codes as listed below.

Function code	Name	Data	Factory default
F01	Frequency command 1	1: Analog voltage input to terminal [12]	0
F02	Operation method	1: External digital input signal	0
E98	Terminal [FWD] function	98: Run forward command FWD	98
E99	Terminal [REV] function	99: Run reverse command REV	99

 **Note** If terminal [FWD] and [REV] are ON, the F02 data cannot be changed. First turn those terminals OFF and then change the F02 data.

- (2) Wire the potentiometer to terminals across [13], [12], and [11].
- (3) Connect the run forward switch between terminals [FWD] and [CM] and the run reverse switch between [REV] and [CM].
- (4) To start running the inverter, rotate the potentiometer to give a voltage to terminal [12] and then turn the run forward or reverse switch ON (short-circuit).

 For precautions in wiring, refer to Chapter 2 "SPECIFICATIONS."

5.5.6 Monitoring light alarms



The FRENIC-HVAC identifies abnormal states in two categories--Heavy alarm and Light alarm. If the former occurs, the inverter immediately trips; if the latter occurs, the inverter shows the L-AL on the LCD monitor and flashes the WARN. LED but it continues to run without tripping.

Which abnormal states are categorized as a light alarm ("Light alarm" object) should be defined with function codes H181 to H184 beforehand.

Assigning the **LALM** signal to any one of the digital output signals with any of function codes E20 to E24 and E27 (data = 98) enables the inverter to output the **LALM** signal on that terminal upon occurrence of a light alarm.

 For details of the light alarm objects, refer to Chapter 9, Section 9.3.1 "Alarm Codes."

■ How to reset a light alarm

If the light alarm factor has been removed, pressing the  key stops flashing of the WARN. LED and turns **LALM** signal OFF. If not, pressing the  key turns the WARN. LED ON and then the LED automatically goes OFF the moment the light alarm factor is removed.

■ How to check a light alarm factor

If a light alarm occurs, an alarm code appears on the LCD monitor. To check the current light alarm factor, enter Programming mode by pressing the  key and select "2. Light Alarm History" of "4. Alarm Info." It is possible to check the factors of the last five light alarms.

5.6 Programming Mode

Programming mode allows the setting and confirmation of function codes, and monitoring of maintenance-related and input/output (I/O) terminal information, as well as other functions. A menu format is used to enable simple function selection. The menu transition for programming mode is shown below.

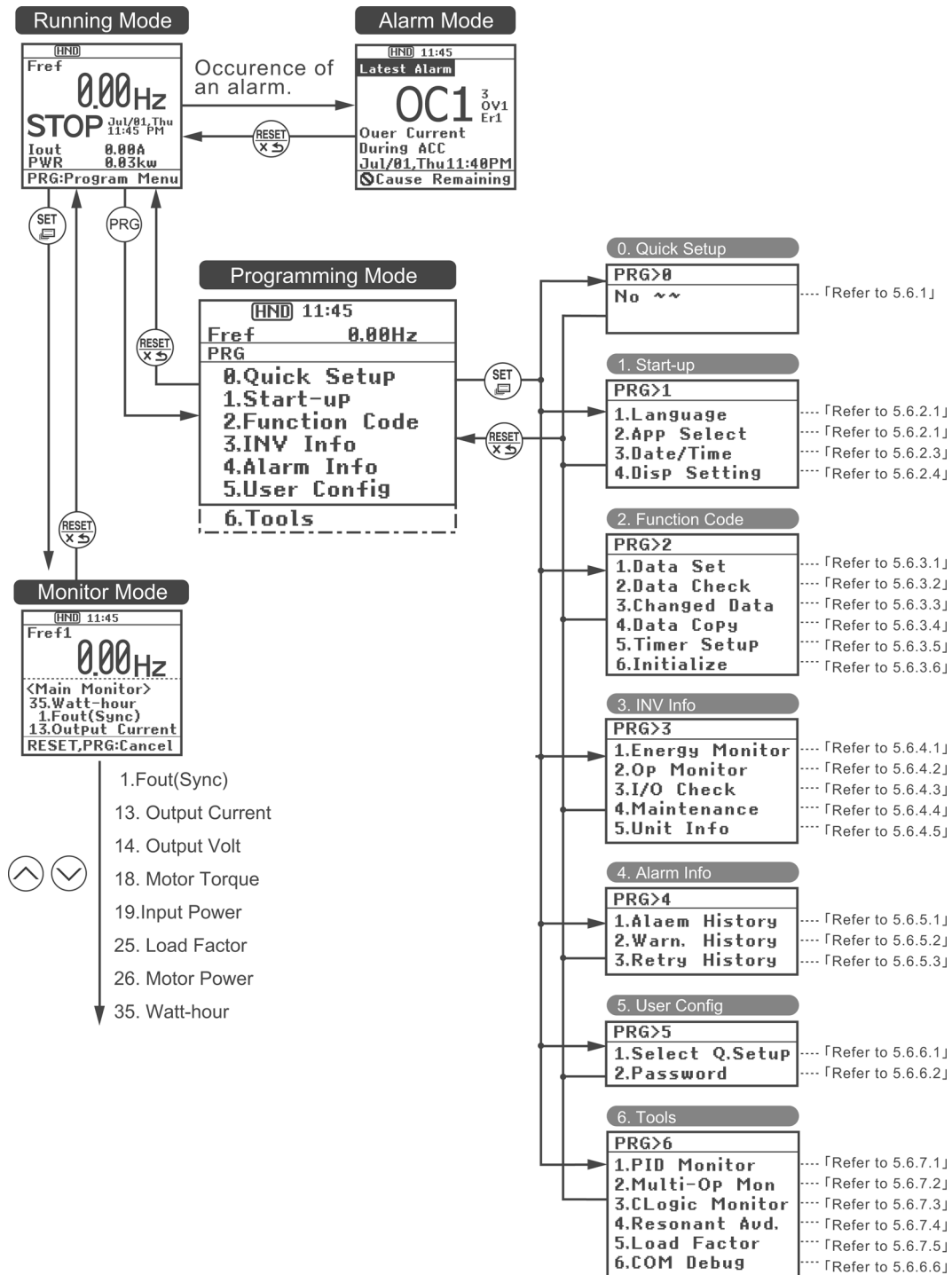

Basic Screen Configuration

■ Main menu screen

Pressing the  key while the Running mode screen is displayed will show the main menu screen.

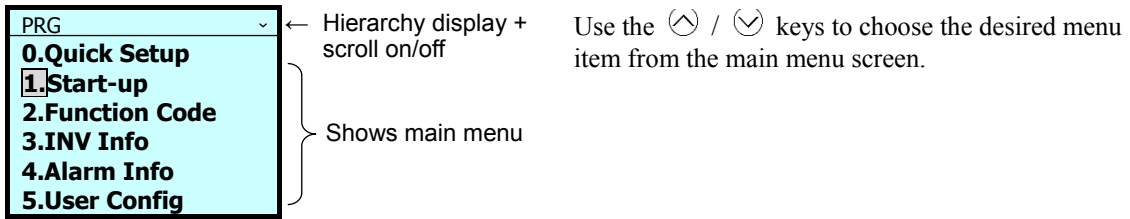

■ Hierarchy display

The hierarchical structure for each screen is "Main menu" ⇒ "Sub-menu" ⇒ "Detailed menu" ⇒ "Data revision screen". Make each menu selection to move to the data revision screen.

Explanation of designation

In this manual, the menu transition of Programming mode ⇒ Main menu item 1, "Start-up" ⇒ Sub-menu item 3, "Date/Time" ⇒ Detailed menu item 2, "Adjust" will be shown as PRG > 1(Start-up) > 3(Date/Time) > 2(Adjust).

Menu types are shown in Table 5.12.

Table 5.12 Programming Mode Menus

Main Menu	Sub-Menu	Hierarchy Display	Principal Functions
0. Quick Setup: Shows only frequently used function codes.			
	—	—	PRG>0
1. Start-up: Sets functions for initial settings.			
	1	Language	PRG>1>1 Sets language to be displayed on LCD monitor.
	2	Select application	PRG>1>2 Allows individual initialization of function codes that are grouped by application.
	3	Set clock	PRG>1>3 Allows setting of date, time and daylight saving time. Date and time display format can also be changed.
	4	Set display	PRG>1>4 Selects content to be displayed on LCD screen.
2. Function Code: Setting screens related to function codes, such as setting/copying function code data.			
	1	Set data	PRG>2>1 Allows function code data to be displayed/changed.
	2	Confirm data	PRG>2>2 Allows confirmation of function code settings.
	3	Confirm revised data	PRG>2>3 Allows confirmation of function code changes from factory-default settings.
	4	Copy data	PRG>2>4 Reads, writes and verifies function code data.
	5	Timer operation	PRG>2>5 Allows setting of timer operation status.
	6	Initialize data	PRG>2>6 Restores function code data values to factory-default settings.

Table 5.12 Programming Mode Menus (Continued)

Main Menu	Sub-Menu	Hierarchy Display	Principal Functions	
3. INV Info: Allows monitoring of inverter operational status.				
	1	Power monitor	PRG>3>1	Allows monitoring of the estimated amount of power.
	2	Operation monitor	PRG>3>2	Displays operational information.
	3	I/O check	PRG>3>3	Displays external interface information.
	4	Maintenance information	PRG>3>4	Displays cumulative run time and other information used during maintenance.
	5	Unit information	PRG>3>5	Allows confirmation of inverter type, serial number and ROM number.
4. Alarm Info: Displays alarm information.				
	1	Alarm history	PRG>4>1	Lists alarm history (newest + 9 previous). Detailed information can be confirmed for the four most recent occurrences.
	2	Light alarm history	PRG>4>2	Lists light alarm history (newest + 5 previous).
	3	Retry history	PRG>4>3	Displays retry history (two instances).
5. User Config: Allows any settings to be made.				
	1	Quick setup selection	PRG>5>1	Allows function codes to be added to or deleted from the "0. Quick Setup" display.
	2	Password	PRG>5>2	Allows setting to prevent inverter function code access or data revision.
6. Tools: Various functions				
	1	PID monitor	PRG>6>1	Allows status of PID controls 1 and 2 and external PID controls 1, 2 and 3 to be monitored. (PV, SV, MV, etc.)
	2	Unit number control monitor	PRG>6>2	Allows confirmation of the operational status on the pump number control.
	3	CLogic monitor	PRG>6>3	Previews and debugs customized logic.
	4	Resonance prevention	PRG>6>4	During operation, allows jump frequency to be set while confirming resonance status.
	5	Load Factor Measurement	PRG>6>5	Allows measurement of the operational status of the maximum output current and average output current.
	6	Signal debug	PRG>6>6	Allows monitoring and setting of communication-specific function codes (S, M, W, W1, W2, W3, X, X1, Z).

5.6.1 Quick Setup

PRG > 0(Quick Setup)

In programming mode, menu number 0, "Quick Setup" shows only those function codes predetermined to have a high usage frequency.

Menu number 5, "User Config" can be used to add or delete function codes from the Quick Setup.

5.6.2 Start-up

PRG > 1(Start-up)

In programming mode, menu number 1, "Start-up" allows display of information needed on startup: the language displayed on the LCD monitor, data and time settings, and inverter operational status.

5.6.2.1 Set Display Language

PRG > 1(Start-up) > 1(Language)

Allows for setting of the keypad display language (19 languages + customizable language).

Key operations and screen transitions are shown.

RESET Return to previous screen PRG Return to running

1. Press the PRG key while the running mode screen is displayed.
2. Use the ▲ / ▼ keys to select [1. Start-up], and confirm with the SET key.
3. Use the ▲ / ▼ keys to select [1. Language], and confirm with the SET key.
4. Use the ◀ / ▶ keys to shift the cursor, and use the ▲ / ▼ keys to select the language you wish to set.

<Selections>
 0:Japanese, 1:English, 2:German, 3:French, 4:Spanish, 5:Italian, 6:Chinese,
 8:Russian, 9:Greek, 10:Turkish, 11:Polish, 12:Czech, 13:Swedish, 14:Portuguese,
 15:Dutch, 16:Malay, 17:Vietnamese, 18:Thai, 19:Indonesian, 100:U.C.L
5. Confirm with the SET key.
6. Finish the setting shown on the menu screen.

5.6.2.2 Function-Specific Initialization

PRG > 1(Start-up) > 2(App Select)

Function-specific initialization allows individual initialization of function codes that are grouped by application.

 Refer to "5.6.3.6 Initialize Data" for details on initialization

5.6.2.3 Date/Time Settings



PRG > 1(Start-up) > 3(Date/Time)

Date and time can be set using a special screen. Setting the data and time also allows time management of timer operation and alarm history. Display location differs, depending on the operation mode.

Replacing the backup battery (option) requires setting the date and time again.



1. Adjust date and time

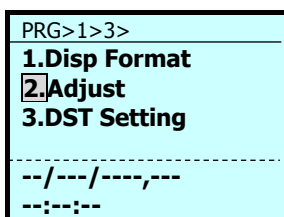
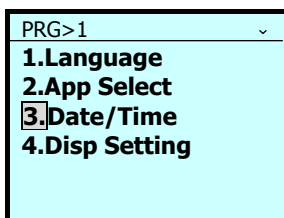
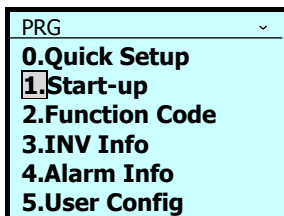
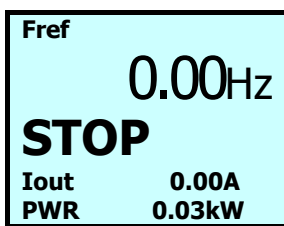

PRG > 1(Start-up) > 3(Date/Time) > 2(Adjust)



 Return to previous screen  Return to running



1. Press the  key while the running mode screen is displayed.

2. Use the  /  keys to select [1. Start-up], and confirm with the  key.

3. Use the  /  keys to select [3. Date/Time], and confirm with the  key.

4. Use the  /  keys to select [2. Adjust], and confirm with the  key.

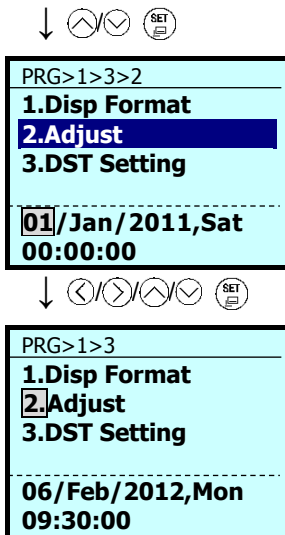

5. Use the / keys to shift the **cursor**, and use the / keys to set the month, day and time. Confirm with the key.

6. Finish the setting shown on the menu screen.

2. Set daylight saving time

PRG > 1(Start-up) > 3(Date/Time) > 3(DST Setting)

Allows for setting of daylight saving time. Settings are for +30 minutes or +60 minutes.

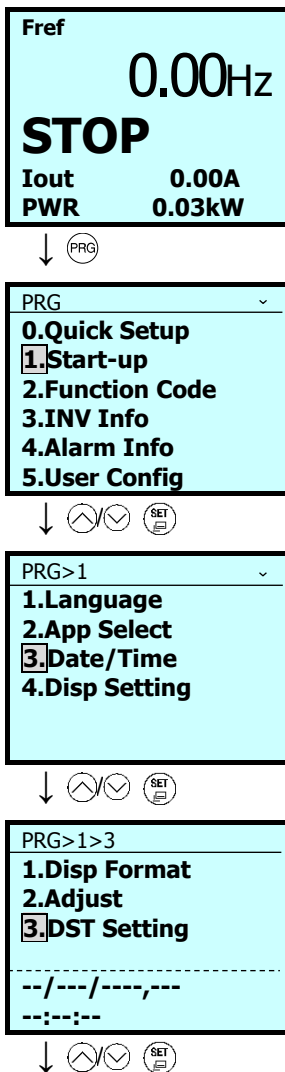
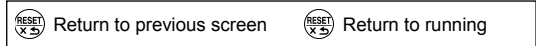

1. Press the key while the running mode screen is displayed.

2. Use the / keys to select [1. Start-up], and confirm with the key.

3. Use the / keys to select [3. Date/Time], and confirm with the key.

4. Use the / keys to select [3. DST Setting], and confirm with the key.

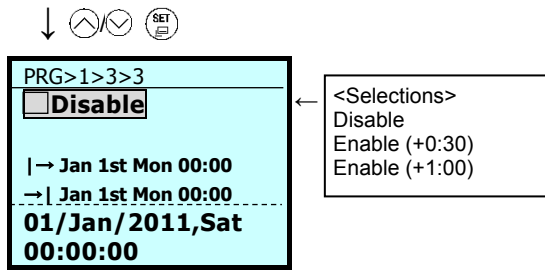

5. Use the \leftarrow / \rightarrow keys to select [Enable(+0:30)] or [Enable(+1:00)]. Use the \rightarrow key to move the cursor.

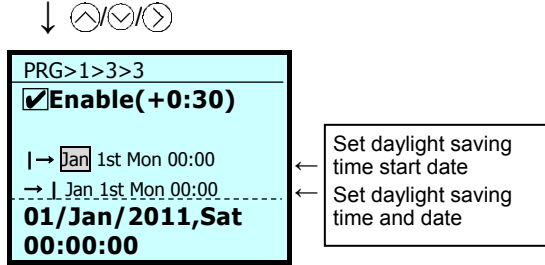

6. Use the \leftarrow / \rightarrow keys to shift the cursor, make the selection, and use the \uparrow / \downarrow keys to input values for the month/date, day and time. Confirm with the SET key.

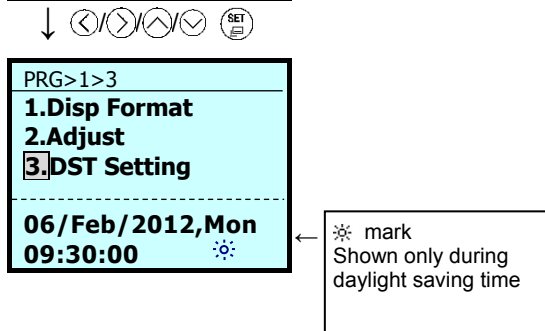

7. Finish the setting shown on the menu screen.

3. Display format

PRG > 1(Start-up) > 3(Date/Time) > 1(Disp Format)

The time and date display format shown on the LCD monitor can be set.

Select the menu item with the \leftarrow / \rightarrow keys and set the format with the \uparrow / \downarrow keys.

5.6.2.4 Set Display

PRG > 1(Start-up) > 4(Disp Setting) > 1 to 18(Sub-menu number)

The equipment's operational status can be determined by displaying its operational status on the keypad.

Follow the settings below to display output frequency, current, torque and other necessary information on the keypad's main monitor and sub-monitors.

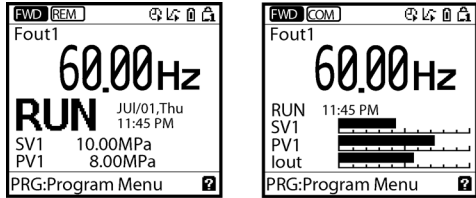
Sub-Menu		Principal Functions	Function Code
1	Screen selection	Selects sub-monitor display (numerical display/bar graph) 	K15
2	Main monitor	Set main monitor display item.*	K10
3	Select speed monitor	Set speed monitor details. If 0 (Speed) is selected as the main monitor content, detailed display data is set.	K11
4	Display selection when stopped	Display selection when main monitor is stopped Set display data when inverter is stopped.	K12
5	Sub-monitor 1	Set sub-monitor 1 display item. *	K16
6	sub-monitor 2	Set sub-monitor 2 display item. *	K17
7	Bar graph 1	Set bar graph 1 display item. *	K20
8	Bar graph 2	Set bar graph 2 display item. *	K21
9	Bar graph 3	Set bar graph 3 display item. *	K22
10	Display filter	Set filter time.	K29
11	Speed display coefficient	Set display coefficient.	K30
12	Units for cumulative amount of power	Change units displayed.	K31
13	Cumulative input watt-hour coefficient	Set display coefficient.	K32
14	Backlight OFF time	Set backlight blackout time.	K02
15	Brightness control	Set backlight brightness.	K03
16	Contrast	Set contrast.	K04
17	Shortcut ⏪	Set shortcut destination for ⏪ key (jump to registered menu).	K91
18	Shortcut ⏩	Set shortcut destination for ⏩ key (jump to registered menu).	K92

 Refer to "5.5.1 Operational Status Monitor, Table 5.7 Monitor Items" for items that can be displayed.

5.6.3 Function Codes

$\text{PRG} > 2(\text{Function Code})$

Function code data settings and changes, such as setting, changing, copying or initializing data, can be made via programming mode menu number 2, "Function Code".

The table below shows function codes that can be used on the FRENIC-HVAC.

Table 5.13 FRENIC-HVAC Function Codes

Function Code Group	Function Codes	Functions	Explanation
F code (Fundamental functions)	F00 to F44	Basic functions	Functions used in basic motor operation
E code (Extension terminal functions)	E01 to E99	Terminal functions	Functions to select control circuit terminal movements
C code (Control functions of frequency)	C01 to C72	Control functions	Applied functions related to frequency settings
P code (Motor 1 parameters)	P01 to P99	Motor 1 parameters	Functions for setting motor capacity and other characteristic parameters
H code (High performance functions)	H03 to H98	High-level functions	Functions related to high-value-added functions, complex controls, etc.
H1 code (High performance functions)	H104 to H197	High-level functions	Functions related to high-value-added functions, complex controls, etc.
J code (Application 1 functions)	J21 to J22	Applied functions 1	Application-related functions
J1 code (PID 1 functions)	J101 to J195	PID control 1	Functions related to PID control 1
J2 code (PID 2 functions)	J201 to J280	PID control 2	Functions related to PID control 2
J5 code (Ext PID functions)	J501 to J553	External PID control 1	Functions related to external PID control 1
J6 code (Ext PID 2/3 functions)	J601 to J690	External PID control 2, 3	Functions related to external PID controls 2, 3
d code (Application 2 functions)	d51 to d99	Applied functions 2	For manufacturer
U code (Custom Logic functions)	U00 to U97	Custom logic	Functions related to customized logic
U1 code (Custom Logic functions)	U101 to U107	Custom logic	Functions related to customized logic
y code (Link functions)	y01 to y99	Link functions	Signal-related functions
T code (Timer functions)	T01 to T70	Timer operation	Functions related to timer operation
K code (Keypad functions)	K01 to K92	Keypad	Functions related to language selection, monitor display settings, time settings, long-term cumulative power monitor and daylight saving time
o code (Option functions)	o01 to o97	Option functions	Functions related to options (Note)

(Note) For o code content, refer to the instruction manuals on individual options.

■ Function codes needed for double-key operation

Double-key operation is required to change the function codes F00 (Data Protection), H03 (Initialize Data), H45 (Mock Alarm), H97 (Clear Alarm Data) and U107 (Automate Conversion Factor). Press the key and the key or the key and the key.

■ Revising, reflecting and storing function code data while running

Data for some function codes can be changed when the inverter is running; others cannot. Furthermore, for some function codes, changing the data will cause those values to be reflected immediately in inverter operation; for other function codes, they will not be reflected. For details, refer to the column on changes while running in the "6.1 Function Code Table" in Chapter 6.

For details on function codes, refer to the "6.1 Function Code Table" in Chapter 6.

5.6.3.1 Setting up function codes

PRG > 2(Function Code) > 1(Data Set)

This section explains how to set function code data.

The examples below show how to change the high-output frequency function code F03 from 50 Hz to 60 Hz.

Return to previous screen Return to running

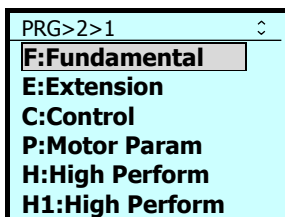
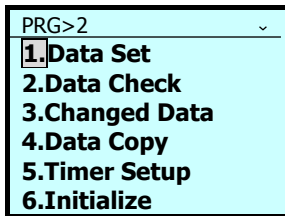
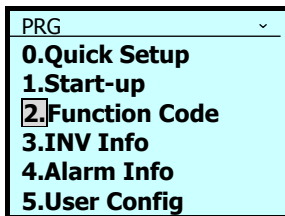
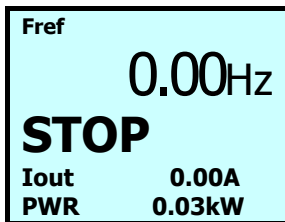

<Selection items>
Selected with
F,E,C,P,H,H1,J,J1,J2,
J3,J4,J5,J6,d,U,y,T,K,
o codes

1. Press the key while the running mode screen is displayed.

2. Use the / keys to select [2. Function Code], and confirm with the key.

3. Use the / keys to select [1. Data Set], and confirm with the key.

4. Use the / keys to select the function code you wish to set (in this case, F: Fundamental).

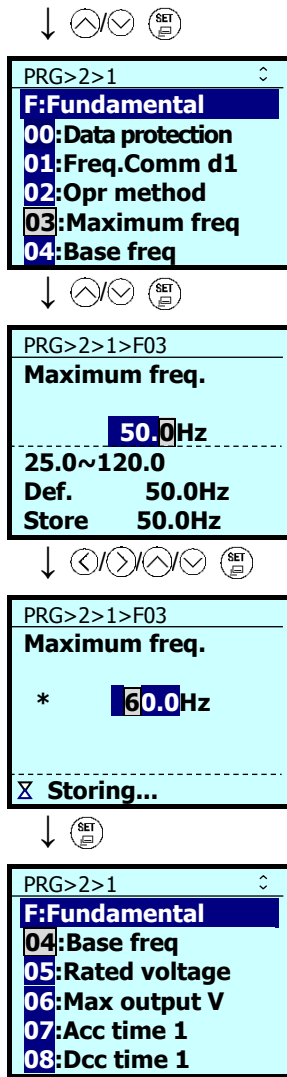

5. Use the (Up/Down) / (Left/Right) keys to move the **cursor**, select the function code that you wish to set (in this case, F03), and confirm with the (SET) key.

6. Use the (Left/Right) keys to shift the **cursor**, and use the (Up/Down) keys to input the value. Confirm with the (SET) key.

<Set data range>
 25.0 to 120.0

7. "Storing" is displayed, and data is saved to the inverter's internal memory.

8. The LCD screen shows the function code following the one that has been set.

5.6.3.2 Confirm Data

PRG > 2(Function Code) > 2(Data Check)

Function codes and function code data can be confirmed at the same time. Also, function codes that have been changed from their factory-set values are accompanied by an asterisk (*). Selecting the function code and pressing the  key allows you to refer to or change the displayed function code data.

The LCD menu transition in the "2. Confirm Data" menu is the same as in "1. Set Data". However, the function code list screen is as shown below.

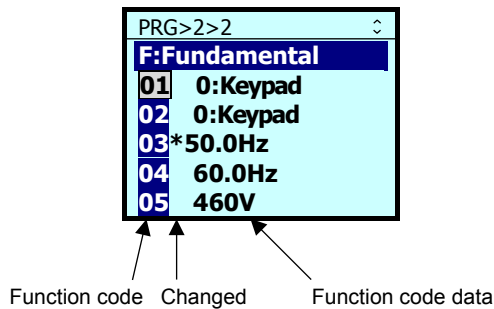

5.6.3.3 Confirm Changed Function Code

PRG > 2(Function Code) > 3(Changed Data)

Only function codes that have been changed from their factory-set values are shown. Selecting the function code and pressing the  key allows you to refer to or change the displayed function code data.

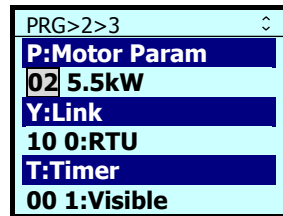

5.6.3.4 Copying data

PRG > 2(Function Code) > 4(Data Copy)

Menu #10 "DATA COPY" in Programming mode provides "Read," "Write," and "Verify" functions, enabling the following applications. The keypad can hold three sets of function code data in its internal memory to use for three different inverters.

- Reading function code data already configured in an inverter and then writing that function code data altogether into another inverter.
- Copying the function code data saved in the inverter memory into the keypad memory for backup.
- Saving function code data in the keypad as master data for data management; that is, saving more than one set of function code data in the keypad and writing a set of data suited to the machinery into the target inverter.

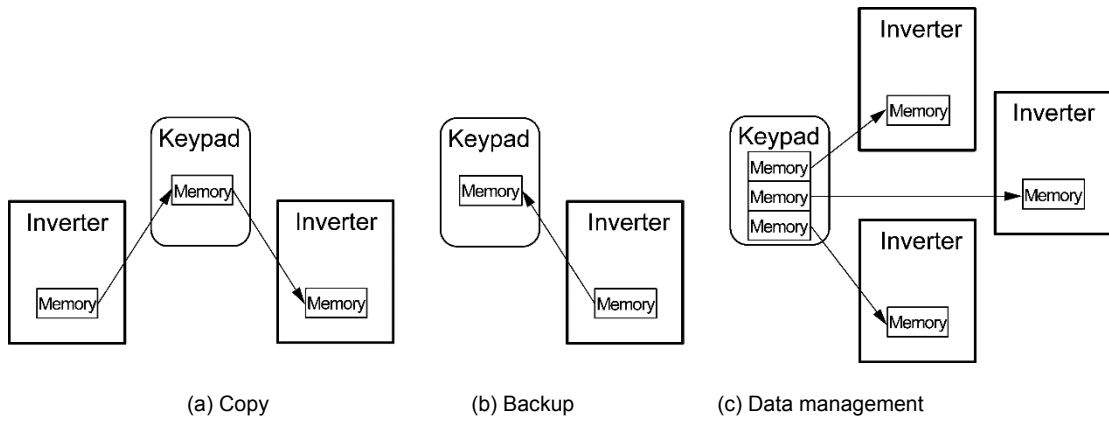



The following functions can be made to sub-menu numbers 1 to 5.

Sub-Menu No	Sub-Menu	Description
1	I.C.V (Safe Light)	Performs inverter initialization, data writing, and verifying automatically.
2	Read: Read data	Reads out function code data from the inverter memory and stores it into the keypad memory.
3	Write: Write data	Writes the data held in the selected area of the keypad memory into the target inverter memory.
4	Verify: Verify data	Verifies the data held in the keypad memory against that in the inverter memory.
5	Confirm: Confirm copied data:	Confirms the model info (type) and function code data of three sets of data held in the keypad memory.



< I.Write: I.C.V (Safe Write) >

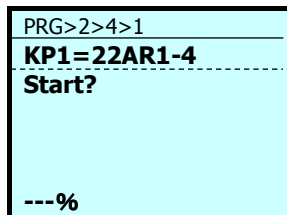
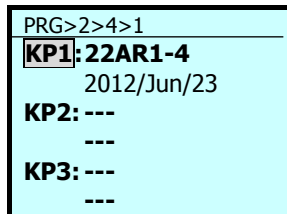
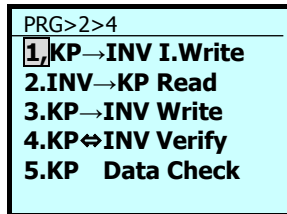
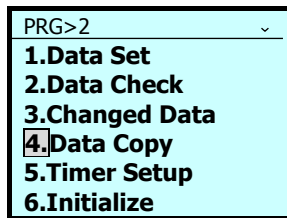
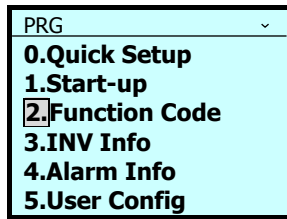
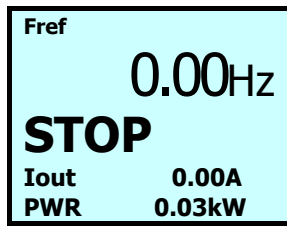

PRG > 2(Function Code) > 4(Data Copy) > 1(KP→INV I.Write)



 Return to previous screen  Return to running







1. Press the  key while the running mode screen is displayed.

2. Use the  /  keys to select [2. Function Code], and confirm with the  key.

3. Use the  /  keys to select [4. Data Copy], and confirm with the  key.

4. Use the  /  keys to select [1. KP→INV I Write], and confirm with the  key.

5. Use the  /  keys to select the location, KP1–KP3, to store the data you wish to write, and confirm the destination with the  key.

6. Pressing the  key writes from the keypad.

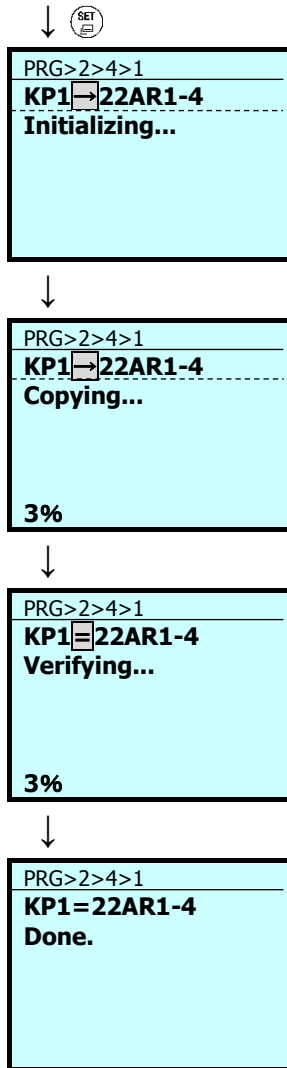

7. Data initialization begins, followed by writing.

8. While writing, the message "Copying..." is displayed, and the percentage of progress is shown.

9. Next, information is verified. During verification, the message "Verifying..." is displayed, and the percentage of progress is shown.

10. If "Done." is displayed, the operation has concluded successfully.

< Read >

PRG > 2(Function Code) > 4(Data Copy) > 2(INV→KP Read)

Return to previous screen Return to running

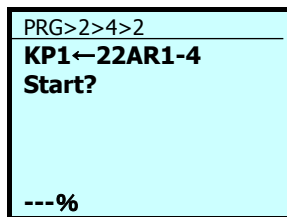
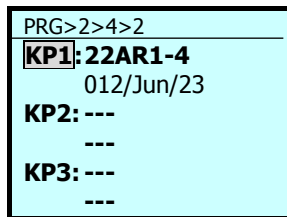
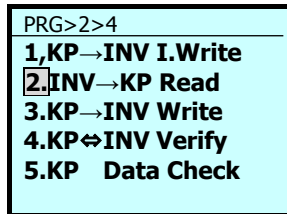
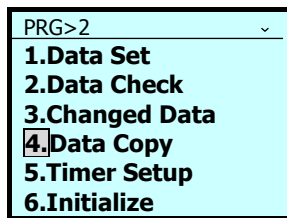
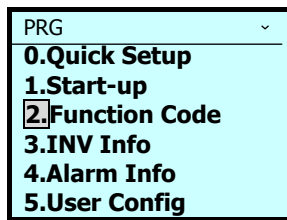
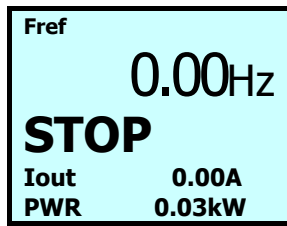

1. Press the key while the running mode screen is displayed.
2. Use the / keys to select [2. Function Code], and confirm with the key.
3. Use the / keys to select [4. Data Copy], and confirm with the key.
4. Use the / keys to select [2. INV→KP Read], and confirm with the key.
5. Use the / keys to select the location, KP1–KP3, to store the data you have read, and confirm the destination with the key.
6. Pressing the key reads from the inverter.

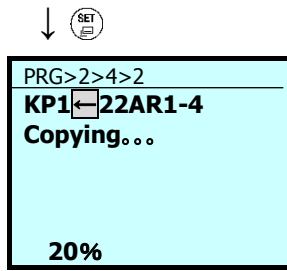

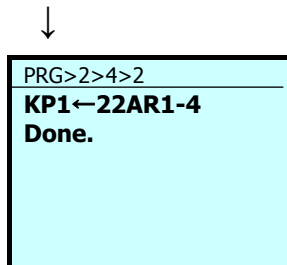

7. While reading, the message "Copying..." is displayed, and the percentage of progress is shown.



8. If "Done." is displayed, the read operation has concluded successfully.

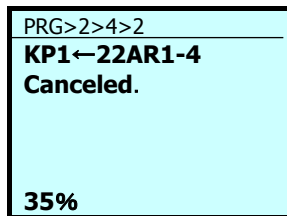

Errors displayed during reading

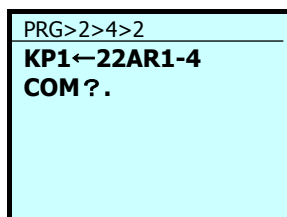

Pressing the  key or the  key during the reading operation cancels the operation, and "Canceled" is shown on the cancel operation screen (Note). If cancelled, all the data stored in the keypad memory is cleared.



If a communication error occurs between the keypad and the inverter while reading, the read error screen will be displayed.

 **Note** If a cancel operation screen, error screen or version mismatch screen is displayed, press the  key or the  key to release. After resetting, the screen returns to programming mode.

< Write >

PRG > 2(Function Code) > 4(Data Copy) > 3(KP→INV Write)

Return to previous screen Return to running

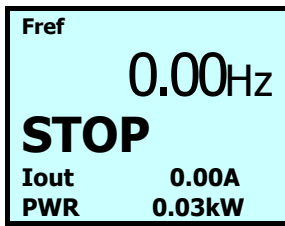

↓

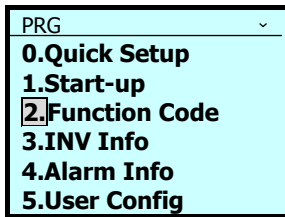

↓

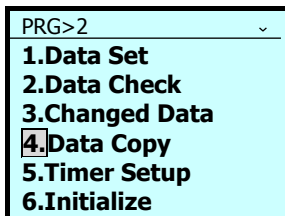

↓

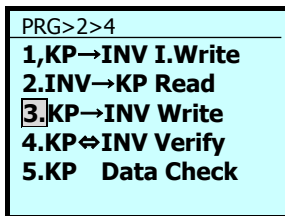

↓

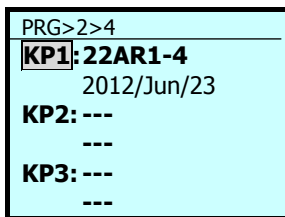

↓

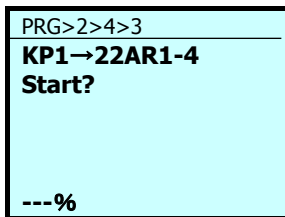

↓

1. Press the key while the running mode screen is displayed.
2. Use the / keys to select [2. Function Code], and confirm with the key.
3. Use the / keys to select [4. Data Copy], and confirm with the key.
4. Use the / keys to select [3. KP→INV Write], and confirm with the key.
5. Use the / keys to select the location, KP1–KP3, to store the data you wish to write, and confirm the destination with the key.
6. Pressing the key writes from the inverter.

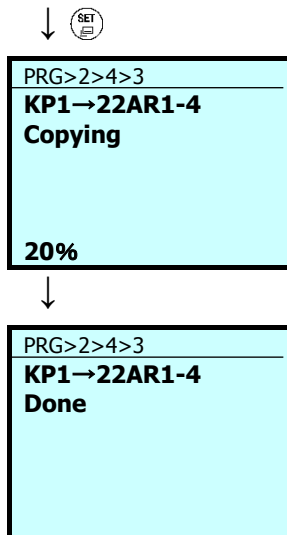



7. While writing, the message "Copying..." is displayed, and the percentage of progress is shown.

8. If "Done." is displayed, the write operation has concluded successfully.

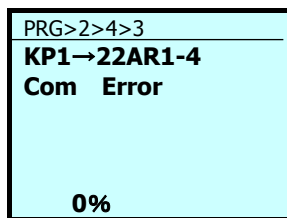
Errors displayed during writing



Pressing the  or  key during data writing cancels the operation that is in progress, "Com Error" is displayed on the cancel operation screen (Note), and the writing operation is forcibly terminated.

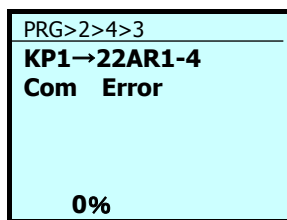

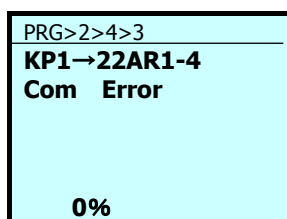

For safety reasons, the following conditions result in errors.

- There is no data stored in the keypad memory.
(If no data has been read at any time since shipping or if the operation was cancelled while data was being read)
- There is an abnormality in the data stored in the keypad memory.
- There is an abnormality in the inverter type.
- Data was written while the inverter was running.
- Inverter data is protected.
- The WE-KP command ("Enable data change with keypad") is OFF.
- There is an abnormality in the data stored in the keypad memory.
- Terminal [FWD]/[REV] is ON.





The function codes stored in the keypad are not compatible with the inverter function codes. (Version upgrades may be non-standard or incompatible. Please contact us.)

 Note If a cancel operation screen, error screen or version mismatch screen is displayed, press the  or  key to release. After resetting, the screen returns to programming mode.

<Verify>

PRG > 2(Function Code) > 4(Data Copy) > 4(KP ↔ INV Verify)

 Return to previous screen
  Return to running

```

Fref
      0.00Hz
STOP
Iout   0.00A
PWR    0.03kW
  
```

↓ 

```

PRG
0.Quick Setup
1.Start-up
2.Function Code
3.INV Info
4.Alarm Info
5.User Config
  
```

↓  /  

```

PRG>2
1.Data Set
2.Data Check
3.Changed Data
4.Data Copy
5.Initialize
  
```

↓  /  

```

PRG>2>4
1.KP→INV I.Write
2.INV→KP Read
3.KP→INV Write
4.KP↔INV Verify
5.KP Data Check
  
```

↓  /  

```

PRG>2>4
KP1: 22AR1-4
      2012/Jun/23
KP2: ---
      ---
KP3: ---
      ---
  
```















↓ 

```

PRG>2>4>4
KP1=22AR1-4
-----
Start?

      20%
  
```

↓ 

1. Press the  key while the running mode screen is displayed.
2. Use the  /  keys to select [2. Function Code], and confirm with the  key.
3. Use the  /  keys to select [4. Data Copy], and confirm with the  key.
4. Use the  /  keys to select [4. KP ↔ INV Verify], and confirm with the  key.
5. Use the  /  keys to select the location, KP1–KP3, to store the data to be verified, and confirm the destination with the  key.
6. Pressing the  key implements verification.



```

PRG>2>4>4
KP1=22AR1-4
Verifying. . .

---%

```



```

PRG>2>4>4
KP1=22AR1-4
Done

```

```

PRG>2>4>4
KP1=22AR1-4
Error : F03
Maximum freq
KP1 : 60.0
INV : 120.0
0%

```

7. While verifying, the message "Verifying..." is displayed, and the percentage of progress is shown.

8. If "Done." is displayed, the operation has concluded successfully.

*Note: If there is a mismatch in the function code data, the mismatched function code data is displayed, and verification stops.

9. Pressing the key again restarts verification with the next function code.

Errors displayed during verification

```

PRG>2>4>4
KP1=22AR1-4
Error : F03
Maximum freq
KP1 : 60.0
INV : 120.0
0%

```

If there is a mismatch in the function code data, the mismatched function code data is displayed, and verification stops.

Pressing the key again restarts verification with the next function code.

```

PRG>2>4>4
KP1=22AR1-4
Canceled

0%

```

Pressing the key or the key when verifying cancels the operation that is in progress, "Canceled" is displayed on the cancel operation screen (Note), and the verify operation that is in progress is forcibly terminated.

```

PRG>2>4>4
KP1: 22AR1-4
2012/Jun/23
KP2: ---
---
KP3: ---
---

```

If no data is stored in the keypad, data storage locations KP1–KP3 cannot be selected.

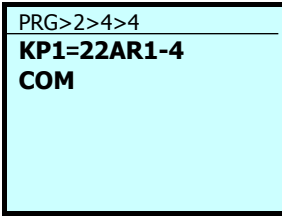

The function codes stored in the keypad are not compatible with the inverter function codes. If no data is available, the verify error screen is shown (Note).

Note If a cancel operation screen, error screen or version mismatch screen is displayed, press the key or the key to release. After resetting, the screen returns to programming mode.

< Confirm copied data >

PRG > 2(Function Code) > 4(Data Copy) > 5(KP Data Check)

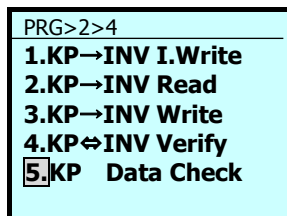
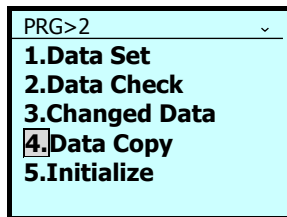
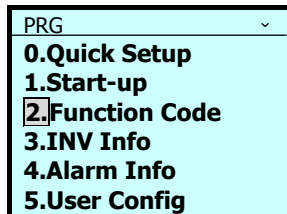
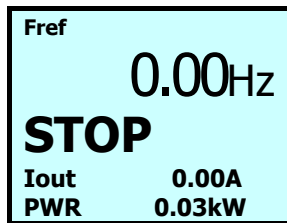
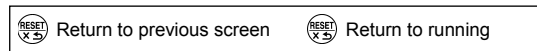

1. Press the key while the running mode screen is displayed.

2. Use the / keys to select [2. Function Code], and confirm with the key.

3. Use the / keys to select [4. Data Copy], and confirm with the key.

4. Use the / keys to select [KP Data Check], and confirm with the key.

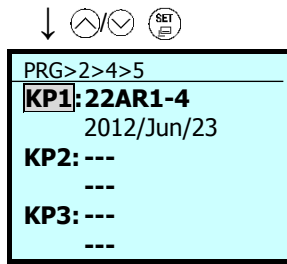

5. Use the / keys to select the location, KP1–KP3, to store the data to be confirmed, and confirm the destination with the key.

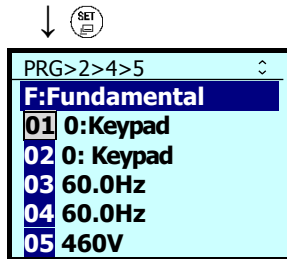

6. Function code data is displayed. Use the / keys to confirm any of the function codes.

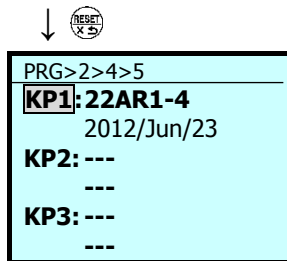

7. Return to the menu screen with the key.

Note If a cancel operation screen, error screen or version mismatch screen is displayed, press the key or the key to release. After resetting, the screen returns to programming mode.

5.6.3.5 Set Timer Operation



PRG > 2(Function Code) > 5(Timer Setup) > 1 to 6(Sub-Menu No.)

Timer operations can be set.









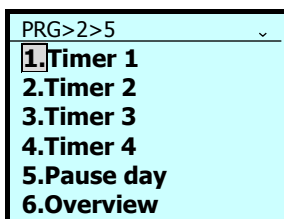
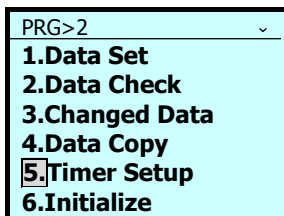
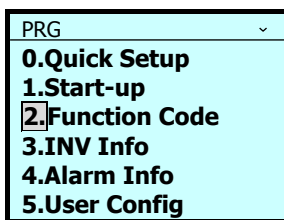
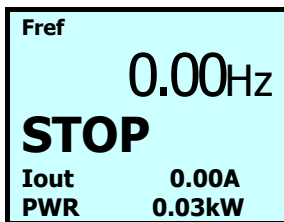

The following content settings can be made to sub-menu numbers 1 to 6.

Sub-Menu No.	Sub-Menu	Principal Functions
1	Timer 1	Select timer 1 operation, set operation start/stop times and days of operation.
2	Timer 2	Select timer 2 operation, set operation start/stop times and days of operation.
3	Timer 3	Select timer 3 operation, set operation start/stop times and days of operation.
4	Timer 4	Select timer 4 operation, set operation start/stop times and days of operation.
5	Pause Day Setting	Set pause days (maximum of 20 days)
6	Timer Graph	Confirm operations of timers 1–4 on a graph (one week)

< Setting Timer 1 PRG>2>5>1 >

 Return to previous screen  Return to running



1. Press the  key while the running mode screen is displayed.
2. Use the  /  keys to select [2. Function Code], and confirm with the  key.
3. Use the  /  keys to select [5. Timer Setup], and confirm with the  key.
4. Use the  /  keys to select the location, Timer 1–Timer 4, to store the data, and confirm the destination with the  key.

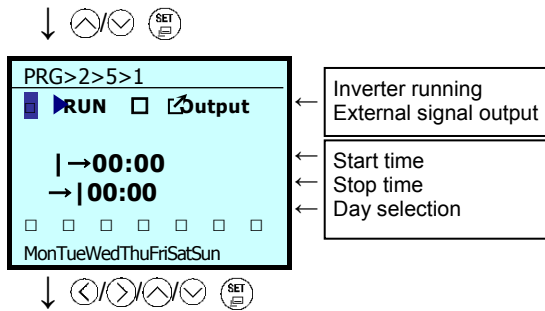

- Use the \leftarrow / \rightarrow keys to shift the **cursor**, and use the \uparrow / \downarrow keys to input the check mark, time and day. Confirm the storage destination with the SET key.

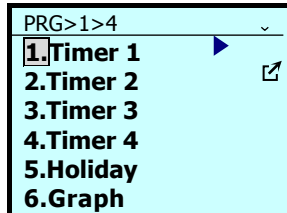

- The menu screen is displayed, and setting is completed. A mar▶ or is shown by the timer in which data is stored, indicating "timer operation due to inverter running" or "timer operation due to external output signal," respectively.

< Setting Pause Day PRG>2>5>5 >

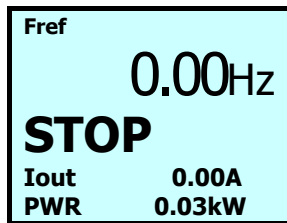

- Press the PRG key while the running mode screen is displayed.

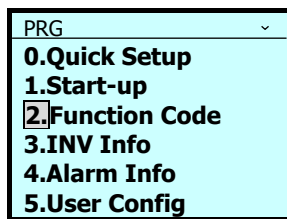

- Use the \uparrow / \downarrow keys to select [2. Function Code], and confirm with the SET key.

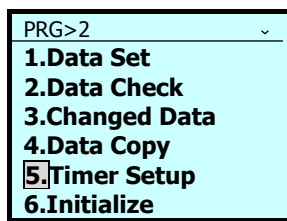

- Use the \uparrow / \downarrow keys to select [5. Timer Setup], and confirm with the SET key.

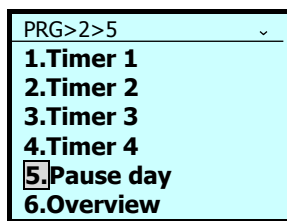

- Move using the \uparrow / \downarrow keys, select [5. Pause day], and confirm with the SET key.

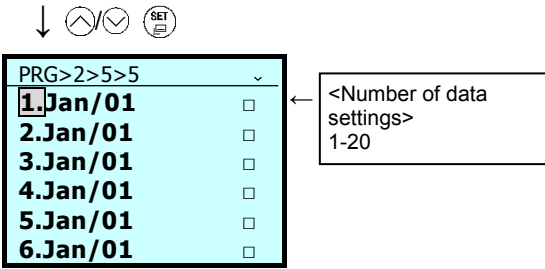

<Number of data settings>
1-20

5. Select item using the \uparrow / \downarrow keys, and confirm with the SET key.
Note: 20 pause days can be set.

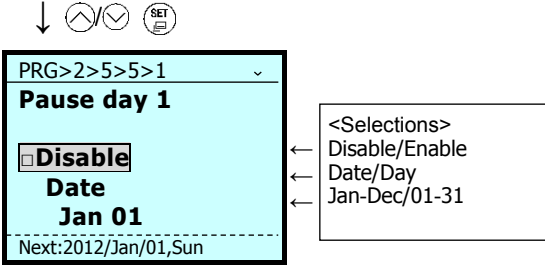

<Selections>
Disable/Enable
Date/Day
Jan-Dec/01-31

6. Use the \uparrow / \downarrow keys to change [Disable] to [Enable].
Use the \rightarrow key to move the cursor, and use the \uparrow / \downarrow keys to input the display method, month/day and other information, and confirm with the SET key.

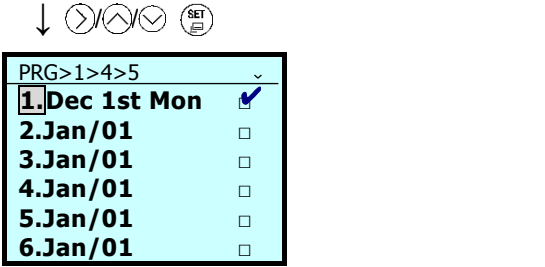

7. The menu screen is displayed, pause days are shown, and setting is completed.



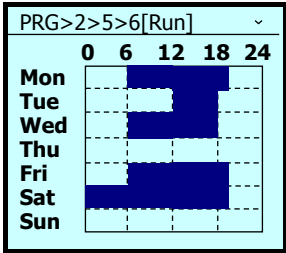

< Timer Graph PRG>2>5>6 >

The time schedule for the timer operation can be displayed on the timer graph screen.
Pressing the \uparrow / \downarrow keys on the screen showing the graph displays [Run] (the time schedule for inverter operation), [Out] (the time schedule for external signal) or [Both] (time schedules for inverter operation and external signal).



5.6.3.6 Initialize Data

PRG > 2(Function Code) > 6(Initialize)

This returns function code data to the values in the factory-default settings. Changing the data requires double-key operation (the  key and the  key or the  key and the  key). The following content settings can be made to sub-menu numbers 0 to 12.

Sub-Menu No.	Sub-Menu	Principal Functions
0	Manually set values	Does not initialize.
1	Initial values (factory-default setting values)	Initialize all function codes (initializes to factory-set values).
2	Initialize Motor 1 parameters	Initialize in accordance with Motor 1 selection (P99) and motor capacity (P02).
10	Initialize time information	Initialize date and time. PRG>1(Start-up)>2(Date/Time) set values are initialized.
11	Limited initialization (initialization except for communication function codes)	Initialize function codes except link functions y01–y20.
12	Limited initialization (customized logic U code initialization)	Initialize function codes except customized logic U codes.

Note: Settings can be made in the same manner for function code H03 (initialize data).

5.6.4 Inverter Information

PRG > 3(INV Info)

5.6.4.1 Confirm Power Level

PRG > 3(INV Info) > 1(Energy Monitor)

This allows confirmation of accumulated power level data calculated by the inverter. Cumulative time can be selected in units of hours, days, weeks or months, with 48 elements stored for each. For example, if months are chosen as the unit, a long period of cumulative power can be confirmed for up to 48 months (four years).

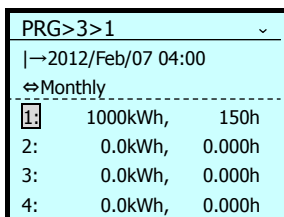
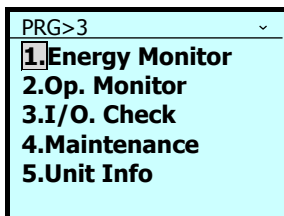
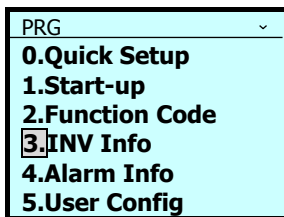
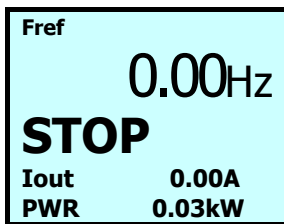

Return to previous screen Return to running

1. Press the key while the running mode screen is displayed.
2. Use the / keys to select [3. INV Info], and confirm with the key.
3. Use the / keys to select [1. Energy Monitor], and confirm with the key.
4. 48 elements for a long period of cumulative power can be confirmed.

5.6.4.2 Confirm Operational Status

$$\boxed{\text{PRG} > 3(\text{INV Info}) > 2(\text{Op Monitor})}$$

This allows confirmation of the inverter's operational status. This can be used when confirming operational status during maintenance or on test runs.

Table 5.14 "Operation Monitor" Display Items

Operational Guide Page No.	Category	Code	Details
1	Set frequency	Fref	Set frequency [Hz]
	Output frequency	Fout1	Output frequency (before slip compensation) [Hz]
	Output frequency	Fout2	Output frequency (temporary frequency) [Hz]
	Output current	Iout	Output current [A]
	Output voltage	Vout	Output voltage [V]
	Calculated torque	Torque	Calculated torque [%]
2	Motor rotational speed	SyncSp	Displayed value = output frequency (Hz) $\times \frac{120}{P01}$ [r/min]
	Load rotational speed	LoadSp	Displayed value = (output frequency Hz) x (function code K30)
3	Current limit	ILimit	Current limited
	Voltage limited	VLimit	Voltage limited
	Torque limit	TtqLimit	Torque limited
	Insufficient voltage limited	LowVolt	Insufficient voltage limited
	Rotational direction limited	RotLimit	Rotational direction limited
4	Frequency attained	FAR	Frequency attained
	Frequency detection	FDT	Frequency detection
	Run preparation	RDY	Run preparation
	Recovering power after momentary power failure	IPF	Recovering power after momentary power failure
	Motor overload	OL	Motor overload
	Keypad operating	KP	Keypad operating
	Fan operating	FAN	Fan operating
	Retrying	TRY	Retrying
	Heat sink overheat early warning	OH	Heat sink overheat early warning
	Lifetime alarm	LIFE	Lifetime alarm
	Overload prevention controlled	OLP	Overload prevention controlled
Current detection	ID	Current detection	
5	Torque limit value A	TLA	Drive-side torque limit value A (calculated according to motor's rated torque) [%]
	Torque limit value B	TLB	Braking-side torque limit value B (calculated according to motor's rated torque) [%]
6	Output current effective value	Iout	Output current effective value [A]
	Output current U phase	-U	Output current U phase [A]
	Output current V phase	-V	Output current V phase [A]
	Output current W phase	-W	Output current W phase [A]
	Power consumption	Power	Power consumption [kW]

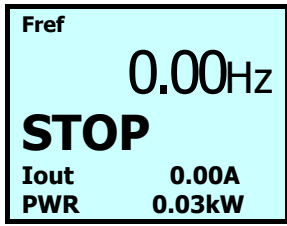

1. Press the **PRG** key while the running mode screen is displayed.

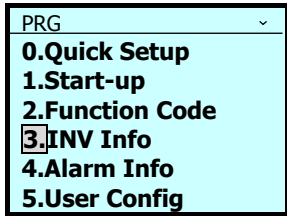

2. Use the **▲** / **▼** keys to select [3. INV Info], and confirm with the **SET** key.

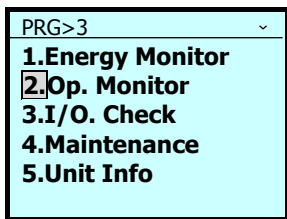

3. Use the **▲** / **▼** keys to select [2. Op Monitor], and confirm with the **SET** key.

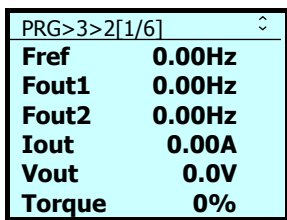

- ← 1/6: Operational guide page number
- ← Set frequency
- ← Output frequency (before slip compensation)
- ← Output frequency (temporary frequency)
- ← Output current
- ← Output voltage
- ← Calculated torque

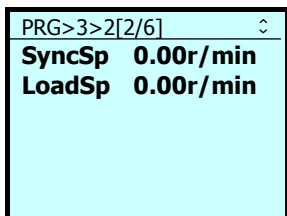

- ← Motor rotational speed
- ← Load rotational speed

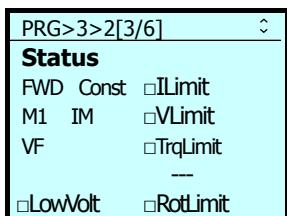

- ← Running direction, output condition^{*1} Deceleration condition^{*2} Current limited
- ← Selected motor Drive motor type Voltage limited
- ← Control method^{*3} Torque limited
- ← Insufficient voltage --- Rotational direction limited

*1 FWD: Moving forward; REV: Moving in reverse
 *2 Const: At constant speed (only when running); Blank: Stopped
 *3 VF: V/F controlled



PRG>3>2[4/6]		
Status2		
<input type="checkbox"/> FAR	<input type="checkbox"/> OL	<input type="checkbox"/> LIFE
<input type="checkbox"/> FDT	---	<input type="checkbox"/> OLP
<input type="checkbox"/> RDY	<input type="checkbox"/> FAN	<input type="checkbox"/> ID
---	<input type="checkbox"/> TRY	---
<input type="checkbox"/> IPF	<input type="checkbox"/> OH	---

←	Frequency attained	Motor overload	Lifetime alarm
←	Frequency detection	---	Overload prevention controlled
←	Run preparation	Fan operating	Current detection
←	Retrying	Heat sink overheat early warning	
←	Recovering power after momentary power failure		



PRG>3>2[5/6]	
TLA	90%
TLB	110%

←	Torque limit value A
←	Torque limit value B



PRG>3>2[6/6]	
Iout	0.00A
-U	0.00A
-V	0.00A
-W	0.00A
Power	0.02kW

←	Output current effective value
←	Output current U phase
←	Output current V phase
←	Output current W phase
←	Power consumption

5.6.4.3 Check Status of Input/Output Signal

PRG > 3(INV Info) > 3(I/O Check)

This allows confirmation of the inverter’s digital input/output signal and analog input/output signal. This can be used when confirming operational status during maintenance or on test runs.

Table 5.15 "I/O Check" Display Items

Operational Guide Page No.	Category	Category Details	Code	Details
1	Di	Control circuit terminal input signal (terminal input)	FWD, REV, X1-X7, EN1, EN2	ON/OFF information on control circuit’s terminal input (Reversal on short-circuit, no reversal when open)
2	Di: Link	Communications port input signal	FWD, REV, X1-X7, XF, XR, RST	Input information on communication-specific function code S06 (Reversal on 1, no reversal on 0)
3	Do	Output signal	Y1-Y4, Y5A, 30ABC	Output signal information
4	Ai/Ao	Analog input signal	12	Terminal 12 input voltage
			C1	Terminal C1 input current
			V2	Terminal V2 input voltage
			FM1-Vo	Terminal FM1 output voltage, output current
			FM2-Vo	Terminal FM2 output voltage, output current

Return to previous screen
 Return to running

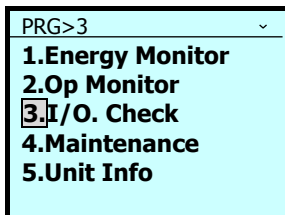
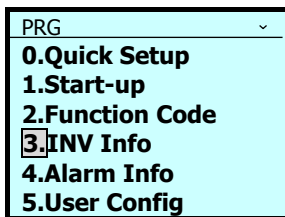
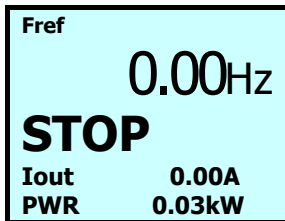

1. Press the key while the running mode screen is displayed.

2. Use the / keys to select [3. INV Info], and confirm with the key.

3. Use the / keys to select [3. I/O Check], and confirm with the key.



```
PRG>3>3[1/4]
Di
□FWD □X1 □X6 ■EN1
□REV □X2 □X7 ■EN2
      □X3
      □X4
      □X5      1800H
```

← **Digital input (input terminal)**



```
PRG>3>3[2/4]
Di:Link
□FWD □X1 □X6 □XF
□REV □X2 □X7 □XR
      □X3      □RST
      □X4
      □X5      0000H
```

← **Digital input (communications terminal)**



```
PRG>3>3[3/4]
Do
□Y1   □30ABC
□Y2
□Y3
□Y4
□Y5A      0000H
```

← **Digital output information**



```
PRG>3>3[4/4]
Ai/Ao
12      +0.0V
C1      0.0mA
V2      +0.0V
FM1-Io  4.0mA
FM2-Io  4.0mA
```

← **Analog input/output**

5.6.4.4 View Maintenance Information

PRG > 3(INV Info) > 4(Maintenance)



Displays information needed for inverter maintenance.

Table 5.16 "Maintenance Information" Display Items

Operational Guide Page No.	Category	Code	Details
1	Cumulative run time	Time	Shows cumulative time inverter's main power has been on. Reverts to 0 after exceeding 65,535 hours and begins counting up again.
	DC link bus voltage	Edc	Shows DC link bus voltage of inverter's main circuit.
	Maximum effective current value	Imax	Shows as the effective value the maximum inverter output current each hour.
	Cumulative power level	Wh	Shows cumulative power level. Reverts to 0 after passing 1,000,000 kWh.
	Cumulative power data	PDat	Cumulative power data shown as cumulative power level (kWh) x function code K32. (Display range: 0.001–9999; data of 9999 or higher is limited to 9999.)
2	Capacity of main circuit capacitor	Cap	Current capacity of main circuit capacitor is shown, using capacity at time of shipment as 100%. For details, refer to "Chapter 10. Maintenance and Inspection" in the inverter unit instruction manual.
	Main circuit capacitor life (Powered life)	EneT	Shows as total elapsed time the period during which a voltage has been applied to the electrolytic capacitor on the main circuit. The capacity of the electrolytic capacitor on the main circuit is measured when the main power is OFF, and elapsed time is revised.
	Main circuit capacitor life (Remaining life)	RemT	Shows the remaining life of the electrolytic capacitor on the main circuit. Remaining life is calculated by subtracting elapsed time from the service life (five years).
3	Life of electrolytic capacitor on PCB (Powered life)	EneT	Shows as cumulative run time the product of the cumulative amount of time during which a voltage has been applied to the electrolytic capacitor on the PCB times a coefficient to account for ambient temperature conditions.
	Target life of electrolytic capacitor on PCB	Life	Shows the remaining life of the electrolytic capacitor on the PCB. Remaining life is calculated by subtracting elapsed time from the service life (five years).
	Powered life of cooling fan	EneT	Shows the total amount of time the cooling fan has been in operation. Time when the cooling fan ON-OFF control (function code H06) is enabled and the cooling fan is off is not counted.
	Target life of cooling fan	Life	Shows the cooling fan's remaining service life. Remaining life is calculated by subtracting elapsed time from the service life (five years).
4	Cumulative motor run time	EneT	Shows the motor's cumulative run time. Reverts to 0 after exceeding 99,990 hours and begins counting up again.
	Remaining time to motor maintenance	RemT	Shows the amount of time remaining until the next maintenance. The value shown is calculated by subtracting cumulative motor run time from the set maintenance time (H78).
	Number of startups	EneN	Accumulates and shows the number of motor operations (the number of times the inverter run command has been ON). Reverts to 0 after exceeding 65,535 times and begins counting up again.
	Number of startups remaining to motor maintenance	RemN	Indicates the number of startups until the next maintenance. The value shown is calculated by subtracting the number of startups from the maintenance setting for the number of startups (H79).



Table 5.16 "Maintenance Information" Display Items (continued)

Operational Guide Page No.	Category	Code	Details
5	Interior temperature (Real-time value)	Int	Shows the current temperature inside the inverter.
	Maximum interior temperature	Int(max)	Shows the maximum temperature inside the inverter in one-hour increments.
	Heat sink temperature (Real-time value)	Fin	Shows the current temperature of the heat sink inside the inverter.
	Maximum heat sink temperature	Fin(max)	Shows the current temperature of the heat sink inside the inverter.
6	RS-485 error (Communications port 1)	Ch1	Shows the cumulative number of times an error has arisen at RS-485 (communications port 1) and the code for the most recent error.
	RS-485 error (Communications port 2)	Ch2	Shows the cumulative number of times an error has arisen at RS-485 (communications port 2) and the code for the most recent error.
	Option error (A-port)	OpA	Shows the cumulative number of times an error has arisen in option communications when loading the option (A-port) and the code for the most recent error.
	Option error (B-port)	OpB	Shows the cumulative number of times an error has arisen in option communications when loading the option (B-port) and the code for the most recent error.
	Option error (C-port)	OpC	Shows the cumulative number of times an error has arisen in option communications when loading the option (C-port) and the code for the most recent error.
7	Inverter ROM version	Main	Shows the inverter ROM version as four digits.
	Keypad ROM version	KP	Shows the keypad ROM version as four digits.
	Option (A-port) ROM version	OpA	Shows the option (A-port) ROM version as four digits.
	Option (B-port) ROM version	OpB	Shows the option (B-port) ROM version as four digits.
	Option (C-port) ROM version	OpC	Shows the option (B-port) ROM version as four digits.

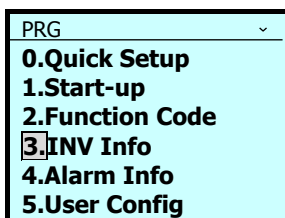
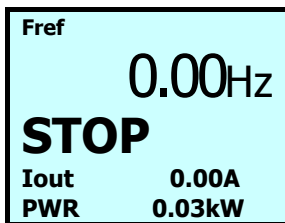
 Return to previous screen  Return to running



1. Press the  key while the running mode screen is displayed.

2. Use the  /  keys to select [3. INV Info], and confirm with the  key.

↓ (Left Arrow) (Right Arrow) (SET)

PRG>3

1. Energy Monitor
 2. Op. Monitor
 3. I/O. Check
4. Maintenance
 5. Unit Info

↑ (Left Arrow) (Right Arrow)

PRG>3>4[1/7]

Operation

Time 7hours
 Edc 590V
 Imax 0.00A
 Wh 0.0003kWh
 PDat 0.000

← Cumulative run time
 ← DC link bus voltage
 ← Maximum effective current value
 ← Cumulative power level
 ← Cumulative power data

↑ (Left Arrow) (Right Arrow)

PRG>3>4[2/7]

Main Capacitor

Cap 0.0%
 EneT 0hours
 RemT 43500hours

← Capacity of main circuit capacitor
 ← Powered life of main circuit capacitor
 ← Remaining life of main circuit capacitor

↑ (Left Arrow) (Right Arrow)

PRG>3>4[3/7]

PCB Capacitor

EneT 0hours
 Life 43500hours

Cooling Fan

EneT 0hours
 Life 43500hours

← Powered life of electrolytic capacitor on PCB
 ← Service life of electrolytic capacitor on PCB

← Powered life of cooling fan
 ← Target life of cooling fan

↑ (Left Arrow) (Right Arrow)

PRG>3>4[4/7]

Motor

EneT 0hours
 RemT 43500hours
 EneN 1
 RemN 0

← Cumulative motor run time
 ← Remaining time to motor maintenance
 ← Number of motor startups
 ← Times remaining to motor maintenance

↑ (Left Arrow) (Right Arrow)

PRG>3>4[5/7]

Temperature

Int 36°C
 (Max) 36°C
 Fin 36°C
 (Max) 36°C

← Temperature inside inverter (Real-time value)
 ← Temperature inside inverter (Maximum value)
 ← Heat sink temperature (Real-time value)
 ← Heat sink temperature (Maximum value)

↑ (Left Arrow) (Right Arrow)

3. Use the (Left Arrow) / (Right Arrow) keys to select [4. Maintenance], and confirm with the (SET) key.



PRG>3>4[6/7]		
COM Error		
Ch1	0	—
Ch2	0	—
OpA	0	—
OpB	0	—
OpC	0	—

- ← Number of RS-485 errors (communications port 1)
- ← Number of RS-485 errors (communications port 2)
- ← Option error details (A-port)
- ← Option error details (B-port)
- ← Option error details (C-port)



PRG>3>4[7/7]		
ROM Number		
Main	1000	
KP	5000	
OpA	0000	
OpB	0000	
OpC	0000	

- ← Inverter ROM version
- ← Keypad ROM version
- ← Option ROM version (A-port)
- ← Option ROM version (B-port)
- ← Option ROM version (C-port)

5.6.4.5 View Unit Information

PRG > 3(INV Info) > 5(Unit Info)

Shows inverter type, serial number and ROM version.

Return to previous screen Return to running

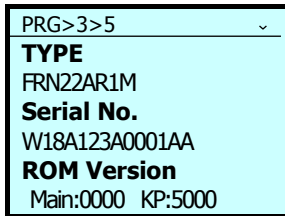
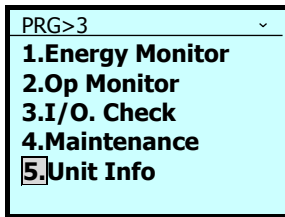
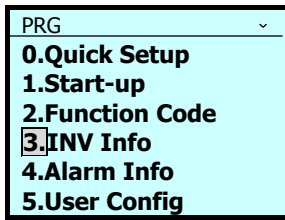
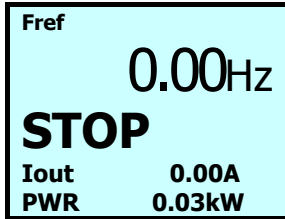

← Inverter type
 ← Serial number
 ← Main: Inverter ROM version; KP: Keypad ROM version

1. Press the key while the running mode screen is displayed.
2. Use the / keys to select [3. INV Info], and confirm with the key.
3. Use the / keys to select [4. Maintenance], and confirm with the key.

5.6.5 Alarm Information

PRG > 4(Alarm Info)

5.6.5.1 Confirm Alarm History

PRG > 4(Alarm Info) > 1(Alarm History)



For the most recent alarm and the past nine, shows alarm codes indicating the types of protective functions operated and the number of consecutive alarms. Also, for the most recent alarm and the past three, shows alarm information indicating the inverter status at the time the alarm was triggered.

Table 5.17 "Alarm History" Display Items

Operational Guide Page No.	Category	Code	Details
1/9	Alarm name	—	Name of alarm, date and time occurred
2/9	Set frequency	Fref	Set frequency [Hz]
	Output frequency	Fout1	Output frequency (before slip compensation) [Hz]
	Output current	Iout	Output current [A]
	Output voltage	Vout	Output voltage [V]
	Calculated torque	Torque	Calculated torque [%]
	Speed	Speed	Speed monitor (K11)
3/9	Cumulative run time	Time	Shows cumulative time inverter's main power has been on. Reverts to 0 after exceeding 65,535 hours and begins counting up again.
	Number of startups	EneN	Accumulates and shows the number of motor operations (the number of times the inverter run command has been ON). Reverts to 0 after exceeding 65,535 times and begins counting up again.
	DC link bus voltage	Edc	Shows DC link bus voltage of inverter's main circuit.
	Interior temperature	T.Int	Shows the interior temperature.
	Heat sink temperature	T.Fin	Shows the heat sink temperature.
	Power consumption	Power	Power consumption (only the most recent alarm history stored.)
4/9	Current limit	ILimit	Current limited
	Voltage limited	VLimit	Voltage limited
	Torque limit	TrqLimit	Torque limited
	Insufficient voltage limited	LowVolt	Insufficient voltage limited
	Rotational direction limited	RotLimit	Rotational direction limited

Table 5.17 "Alarm History" Display Items (continued)

Operational Guide Page No.	Category	Code	Details
5/9	Frequency attained	FAR	Frequency attained
	Frequency detection	FDT	Frequency detection
	Run preparation	RDY	Run preparation
	Recovering power after momentary power failure	IPF	Recovering power after momentary power failure
	Motor overload	OL	Motor overload
	Fan operating	FAN	Fan operating
	Retrying	TRY	Retrying
	Heat sink overheat early warning	OH	Heat sink overheat early warning
	Lifetime alarm	LIFE	Lifetime alarm
	Overload prevention controlled	OLP	Overload prevention controlled
	Current detection	ID	Current detection
6/9	Di Control circuit terminal input signal (terminal input)	FWD, REV, X1-X7, EN1, EN2	ON/OFF information on control circuit's terminal input (Reversal on short-circuit, no reversal when open)
7/9	Di: Link Communications port input signal	FWD, REV, X1-X7, XF, XR, R ST	Input information on communication-specific function code S06 (Reversal on 1, no reversal on 0)
8/9	Do Output signal	Y1-Y4, Y5A, 30ABC	Output signal information
9/9	Overlapping alarm 1	O.lap1	Simultaneously triggered alarm codes (No. 1) (If no alarm, shows " --- ")
	Overlapping alarm 2	O.lap2	Simultaneously triggered alarm codes (No. 2) (If no alarm, shows " --- ")



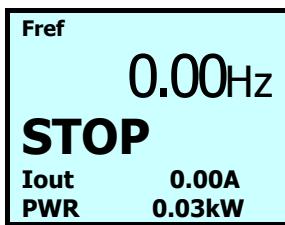

 Return to previous screen  Return to running

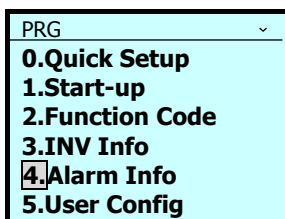

↓ 



↓   

1. Press the  key while the running mode screen is displayed.
2. Use the  /  keys to select [4. Alarm Info], and confirm with the  key.

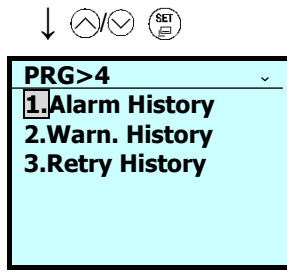

3. Use the (Up/Down) / (Left/Right) keys to select [1. Alarm History], and confirm with the (SET) key.

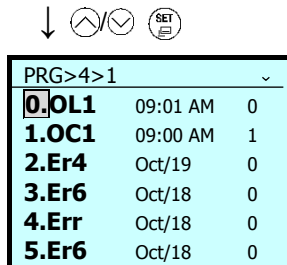

← Most recent alarm Time triggered Number of consecutive alarms
 ← Shows date and time of past alarms

4. Use the (Up/Down) / (Left/Right) keys to select the alarm to check, and confirm with the (SET) key.

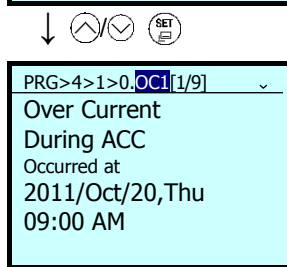

← "----" displayed if no time set

5. Shows alarm details.

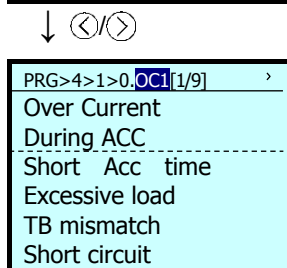

6. Use (Left/Right) / (Right) to show the alarm factor.

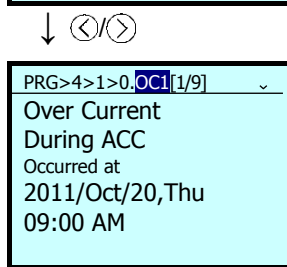

7. Use the (Left/Right) key to confirm the inverter status at the time the alarm occurred.

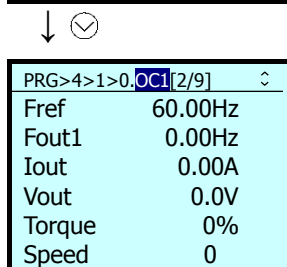

← Set frequency
 ← Output frequency
 ← Output current
 ← Output voltage
 ← Calculated torque
 ← Speed

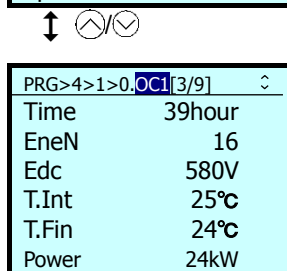

← Cumulative run time
 ← Number of startups
 ← DC link bus voltage
 ← Interior temperature
 ← Heat sink temperature
 ← Power consumption

↑ (Left Arrow) (Right Arrow) (Down Arrow)

```

PRG>4>1>0.OC1[4/9]
Status
INT      □ILimit
M1 IM    □VLimit
VF       □TrqLimit
          ---
□LowVolt □RotLimit
            
```

← FWD, REV, INT: Running forward/reverse, Stopped Current limited

← M1 IM: Induction motor Voltage limited

← VF, DTV, VF-SC: Drive control Torque limited

← Acc, Dec, Const: Accelerating, Decelerating, Constant-speed running

← Undervoltage Rotation direction limited

↑ (Left Arrow) (Right Arrow) (Down Arrow)

```

PRG>4>1>0.OC1[5/9]
Status2
□FAR □OL □LIFE
□FDT --- □OLP
■RDY □FAN □ID
--- □TRY ---
□IPF □OH ---
            
```

← Frequency attained Motor overload Lifetime alarm

← Frequency detection --- Overload prevention controlled

← Run preparation Fan operating Current detection

← --- Retrying

← Recovering power after momentary power failure Heat sink overheat early warning

↑ (Left Arrow) (Right Arrow) (Down Arrow)

```

PRG>4>1>0.OC1[6/9]
Di
□FWD □X1 □X6 ■EN1
□REV □X2 □X7 ■EN2
      □X3
      □X4
      □X5    1800H
            
```

← Digital input (input terminal) information

↑ (Left Arrow) (Right Arrow) (Down Arrow)

```

PRG>4>1>0.OC1[7/9]
Di:Link
□FWD □X1 □X6 □XF
□REV □X2 □X7 □XR
      □X3 □RST
      □X4
      □X5    0000H
            
```

← Digital input (communications terminal)

↑ (Left Arrow) (Right Arrow) (Down Arrow)

```

PRG>4>1>0.OC1[8/9]
Do
□Y1    □30ABC
□Y2
□Y3
□Y4
□Y5A    0000H
            
```

← Digital output information

↑ (Left Arrow) (Right Arrow) (Down Arrow)

```

PRG>4>1>0.OC1[9/9]
Main OC1 9998
0.lap1 --- ---
0.lap2 ---
            
```

← Overlapping alarm information

5.6.5.2 Confirm Light Alarm History

PRG > 4(Alarm Info) > 2(Warn. History)

Light alarm codes are shown for the most recent alarm and the past five.

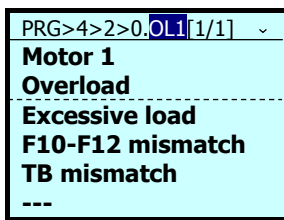
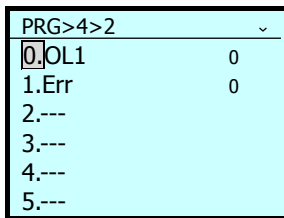
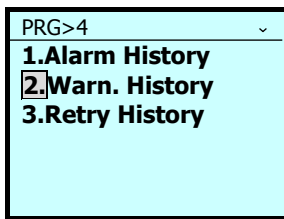
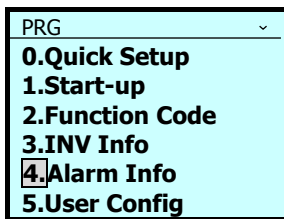
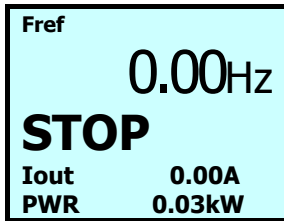

Return to previous screen Return to running

1. Press the key while the running mode screen is displayed.
2. Use the / keys to select [4. Alarm Info], and confirm with the key.
3. Use the / keys to select [2. Warn. History], and confirm with the key.
4. Use the / keys to select the past alarm to check, and confirm with the key.
5. Shows alarm factor.

5.6.5.3 Retry History

PRG > 4(Alarm Info) > 3(Retry History)

If the retry function is used, shows alarm codes for two events if the protective functions targeted by the retry are operating.

Basic key operations are the same as in "5.6.5.2 Confirm Light Alarm History"

5.6.6 User Config

PRG > 5(User Config)

5.6.6.1 Quick Setup

PRG > 5(User Config) > 1(Select Q.Setup)

From programming mode menu number 5, "User Config" function codes can be added to or deleted from the Quick Setup. Target function codes can be added or deleted by selecting them.

5.6.6.2 Password

PRG > 5(User Config) > 2(Password)

Setting the password allows the setting of access to inverter function codes and to prevent data revision.

Password functions are different, as shown below, depending on whether PW1 or PW2 are selected.

Sub-Menu No.	Sub-Menu	Principal Functions
4	User PW1 setting	Setting that allows function codes to be accessed, but data may not be revised.
6	User PW2 setting	Setting that allows no access to function codes, and data may not be revised.
10*	Initialize all	Removes PW1 and PW2.

*) Not shown unless either PW1 or PW2 is set.

< Set Password >

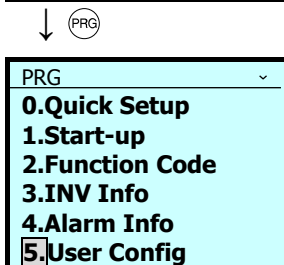
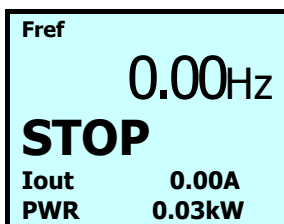

Return to previous screen Return to running

1. Press the key while the running mode screen is displayed.
2. Use the / keys to select [5. User Config], and confirm with the key.

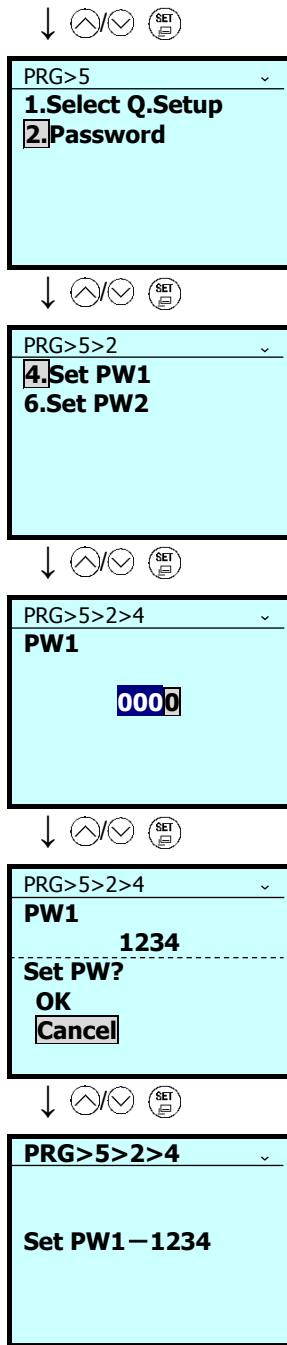

3. Use the / keys to select [2. Password], and confirm with the key.

4. Use the / keys to select the number of the password to be set, [4. Set PW1] or [6. Set PW2], and confirm with the key.

5. Use the / keys to select any four numerical digits, and confirm with the key.

6. Use the / keys to select [OK], and confirm with the key.

7. The set password shown. Selecting [Cancel] returns to the password setting screen.

Note If only the password is set, function code data can be revised. To use the password to prevent function code data from being revised, enable password protection.

< Enable Password Protection >

Return to previous screen Return to running

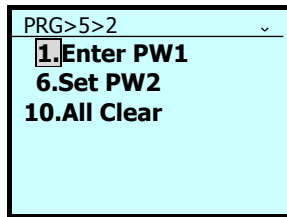
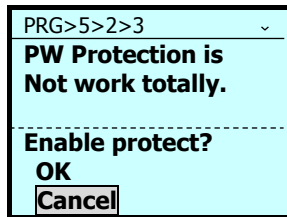
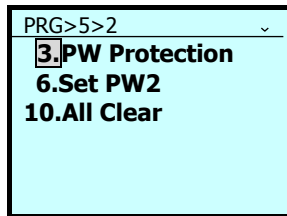
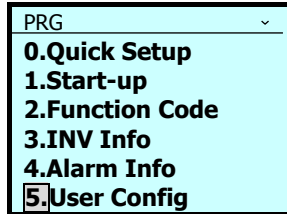
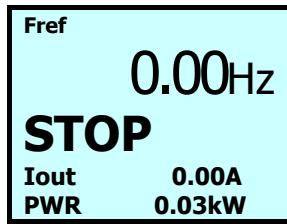

1. Press the key while the running mode screen is displayed.

2. Use the / keys to select [5. User Config], and confirm with the key.

3. "3. PW Protection" indicates that password protection is off (function codes can be revised). To turn password protection on (function codes cannot be revised), select "3. PW Protection" and confirm with the key.

4. Use the / keys to select [OK], and confirm with the key.

By selecting [OK], protection is turned on with the set password.



If password protection is on, function code data cannot be revised. The function code data revision screen displays **Data Protect**.

< Input Password, and Enable Function Code Revision (Turn Off Password Protection) >

PRG5>2 shows the password setting screen.

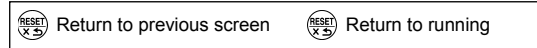
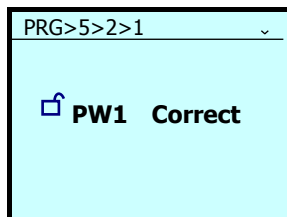
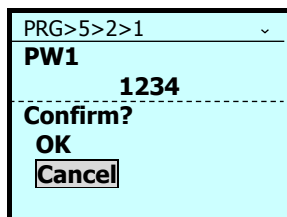
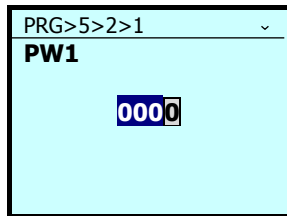
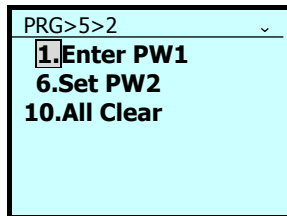
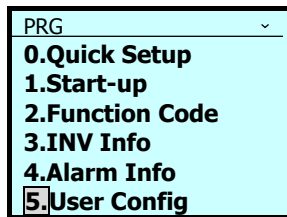
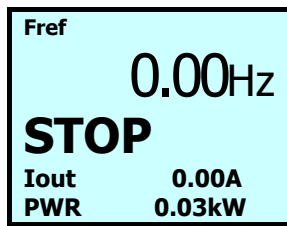

1. Press the key while the running mode screen is displayed.
2. Use the / keys to select [5. User Config], and confirm with the key.
3. With the / keys, if PW1 is set, select [1. Enter PW1], and if PW2 is set, select [2. Enter PW2], and confirm with the key.
4. Use the / keys to input the password that has been set, and confirm with the key.
5. Use the / keys to select [OK], and confirm with the key.
6. The set password is verified, and function code revision is enabled (password protection off).



If the password is entered incorrectly, **PW Incorrect** is displayed. If the password is mistaken five times, operations become impossible (alarm sounds).

■ Password removal

Complete initialization removes passwords.

However, if passwords are removed through complete initialization, function code setting data and password settings will be lost.

Tip Complete initialization requires double-key operation of "STOP" and "PRG" keys."

5.6.7 Tools

PRG > 6(Tools)

5.6.7.1 Monitor PID Control Status

PRG > 6(Tools) > 1(PID Monitor)

The status of PID controls 1 and 2 and external PID controls 1, 2 and 3 can be monitored.

RESET Return to previous screen RESET Return to running

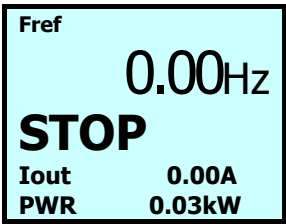

PRG

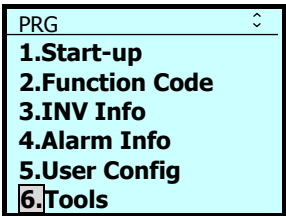

PRG>6

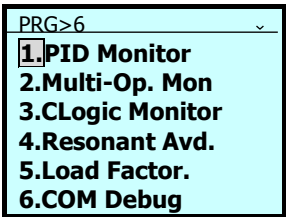

PRG>6>1[1/7]

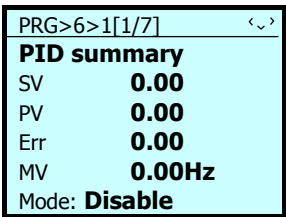

PRG

PID (final) information SV: Command value PV: Feedback value Err: Deviation MV: Manipulated value Mode: PID mode

1. Press the PRG key while the running mode screen is displayed.

2. Use the UP / DOWN keys to select [6. Tools], and confirm with the SET key.

3. Use the UP / DOWN keys to select [1. PID Monitor], and confirm with the SET key.

4. Details can be confirmed with the UP/DOWN/LEFT/RIGHT keys. - Pressing the LEFT/RIGHT keys switches the display unit between the physical quantity and percentage (%). - Pressing the SET key holds the data.

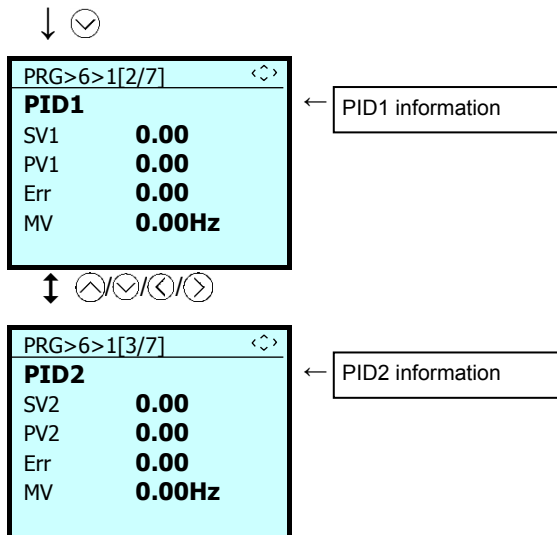

The table below shows the indication for the PID mode.

Indication	Meaning
Disable	PID control disabled
Pause	PID control on standby
Cancel	PID control being canceled
Boost	Under application of pressure due to slow flowrate
Sleep	Stopped due to slow flowrate
Alarm	PID alarm ON
Operating	Running under PID control
Ch.1	PID channel 1 under control
Ch.1/Ch.2 Err	PID channel 2 under control (Deviation on channel 2)
Ch.2	PID channel 2 under control

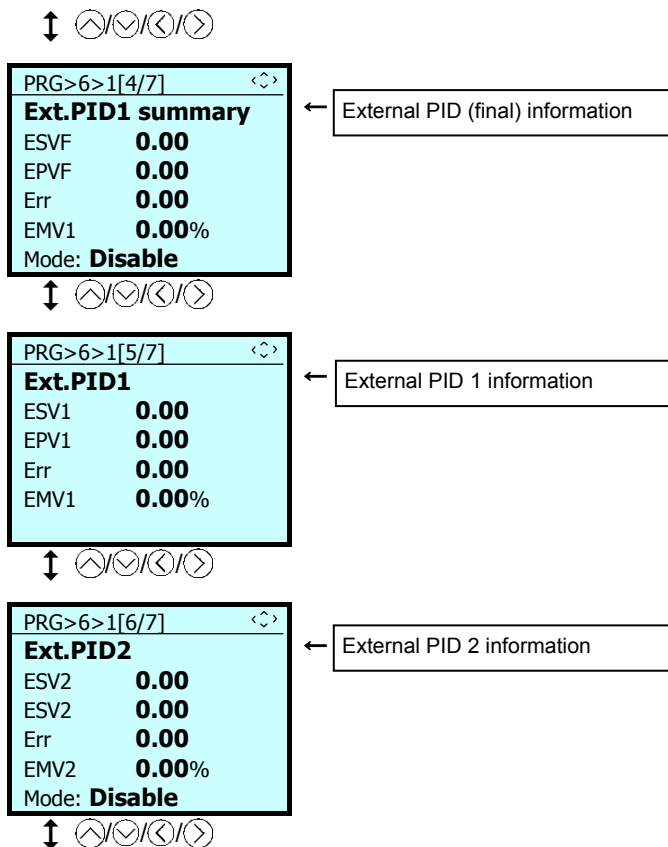

```
PRG>6>1[7/7] <^>
Ext.PID3
ESV3    0.00
EPV3    0.00
Err      0.00
EMV3    0.00%
Mode: Disable
```

← External PID 3 information



```
PRG>6
1.PID Monitor
2.Multi-Op. Mon
3.CLogic Monitor
4.Resonant Avd.
5.Load Factor.
6.COM Debug
```

5. Use the  key to return to the menu screen.

5.6.7.2 Monitor Multiple Unit Controls

PRG > 6(Tools) > 2(Multi-Op.Mon)

The status of cascade operations and mutual operations can be monitored.

< Cascade operation >

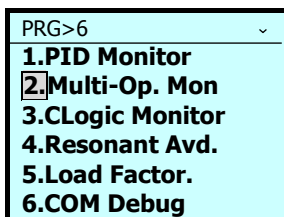
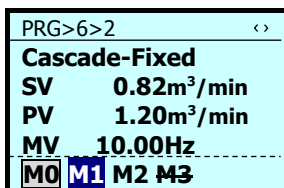
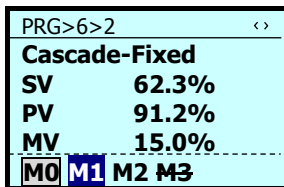
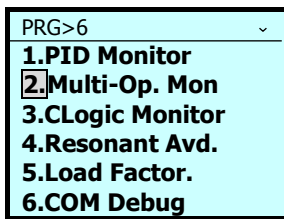
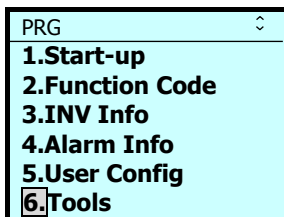
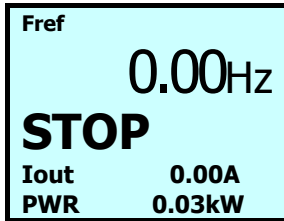

Return to previous screen Return to running

1. Press the key while the running mode screen is displayed.
2. Use the / keys to select [6. Tools], and confirm with the key.
3. Use the / keys to select [2. Multi-Op. Mon], and confirm with the key.

4. The status of cascade operations can be confirmed.

← Command value
← Feedback value
← Operation volume (control volume)

← <Running status>
← blinking: Inverter drive; ON: Commercial drive; blinking: Fire mode
← M2 normal view: Stopped; crossed out: Operation halted

5. Use the / keys to display physical units and switch to a percentage unit display.

← Command value
← Feedback value
← Operation volume (control volume)

← <Running status>
← blinking: Inverter drive; ON: Commercial drive; blinking: Fire mode
← M2 normal view: Stopped; crossed out: Operation halted

6. Use the key to return to the menu screen.

< Mutual operation: Master unit >

Return to previous screen Return to running

Fref
0.00Hz
STOP
Iout 0.00A
PWR 0.03kW

↓

PRG
1.Start-up
2.Function Code
3.INV Info
4.Alarm Info
5.User Config
6.Tools

↓

PRG>6
1.PID Monitor
2.Multi-Op. Mon
3.CLogic Monitor
4.Resonant Avd.
5.Load Factor.
6.COM Debug

↓

PRG>6>2
Mutual-Master
SV 62.3%
PV 91.2%
MV 15.0%
M S1 S2 S3 S4

↓

PRG>6>2
Mutual-Master
SV 0.82m³/min
PV 1.20m³/min
MV 10.00Hz
M S1 S2 S3 S4

↓

PRG>6>2
M RUN-PID
Fout1 60.00Hz
Iout 8.97A
Power 10.25kW

↓

PRG>6>2
S1 RUN-Fmax
Fout1 0.00Hz
Iout 0.00A
Power 0.02kW

↓

1. Press the key while the running mode screen is displayed.

2. Use the / keys to select [6. Tools], and confirm with the key.

3. Use the / keys to select [2. Multi-Op. Mon], and confirm with the key.

4. The status of mutual operations can be confirmed.

← Command value
← Feedback value
← Operation volume (control volume)
← <Operational status>
M blinking: PID operation; **S1** blinking: Maximum frequency operation;
S2 normal view: Stopped; **S3** crossed out: Operating outside mutual control;
S4 crossed out: Operation halted

5. Use the / keys to display physical units and switch to a percentage unit display.

← Command value
← Feedback value
← Operation volume (control volume)
← <Operational status>
M blinking: PID operation; **S1** blinking: Maximum frequency operation;
S2 normal view: Stopped; **S3** crossed out: Operating outside mutual control;
S4 crossed out: Operation halted

← M: Master unit; RUN-PID: PID operation
← Output frequency
← Output current
← Power consumption

← S1: Slave unit 1; RUN-Fmax: Maximum frequency operation
← Output frequency
← Output current
← Power consumption

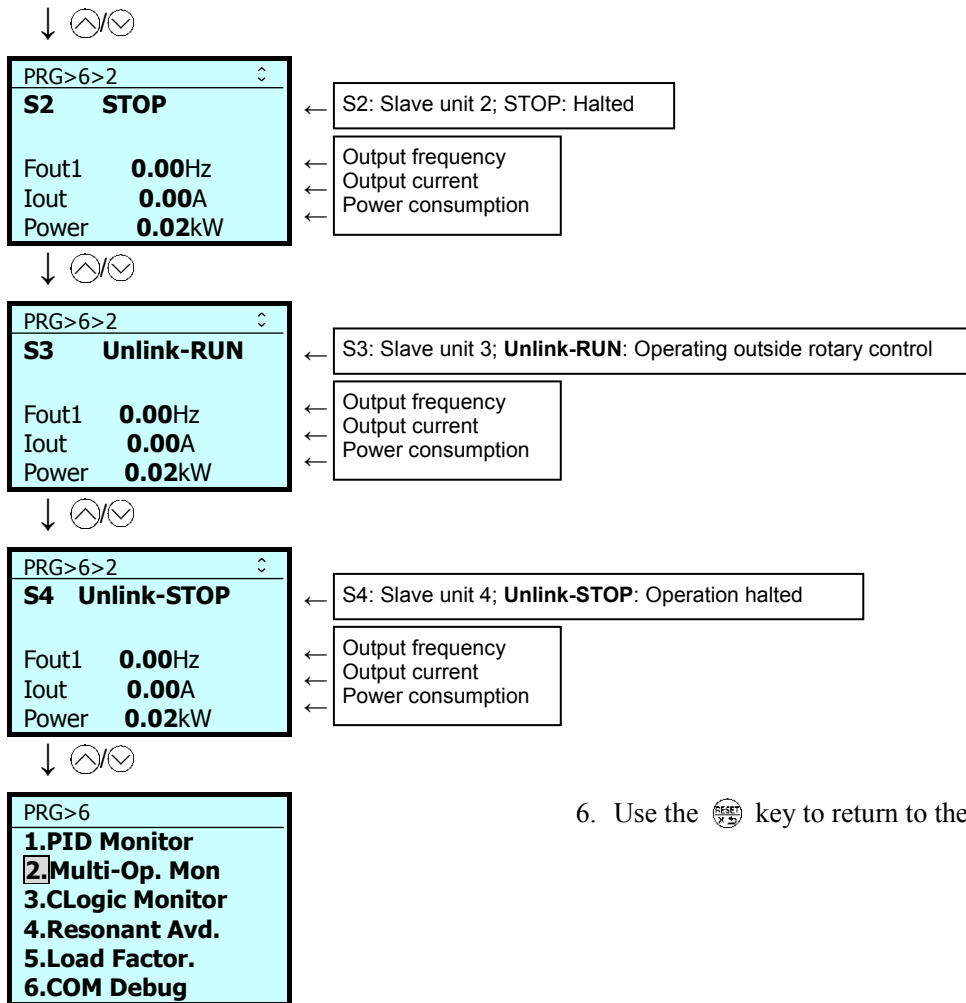

6. Use the key to return to the menu screen.

The table below shows the indication for other slave status.

Indication	Meaning
RUN	On standby
Wire break	Communications link broken

<Mutual operation: Slave units>

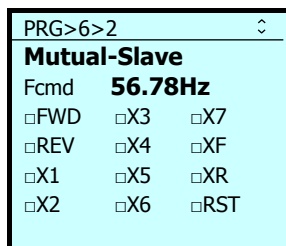



The running status of slave units is shown with the run command, reference frequency and terminal command.

5.6.7.3 Monitor Customized Logic (CLogic)

PRG > 6(Tools) > 3(CLogic Monitor)

Customized logic can be previewed and debugged.

 Return to previous screen	 Return to running
---	---

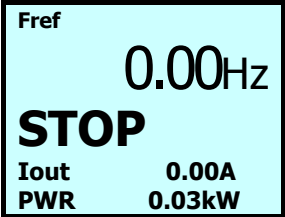

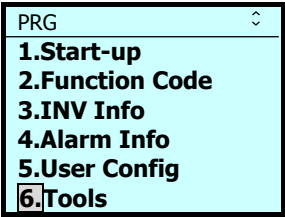

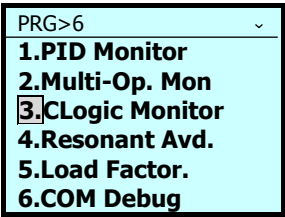

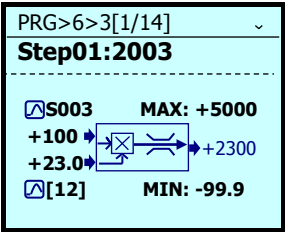



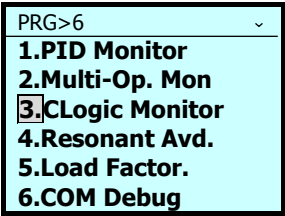







<Selection items>
Step 01 to 14

1. Press the  key while the running mode screen is displayed.
2. Use the  /  keys to select [6. Tools], and confirm with the  key.
3. Use the  /  keys to select [3. CLOGIC Monitor], and confirm with the  key.
4. Show input/output from Step 1.
The  /  keys can be used to confirm up to 14 steps.
The figure at left shows as an example Step01: 2003 (multiplication + upper/lower limits). Inputs: +100, +23; Limits: Upper limit of +5000, lower limit of -99.9; Output : 2300 (Multiplication = 100 x 23 = 2300, limit within scope)
5. Use the  key to return to the menu screen.

5.6.7.4 Resonance Avoidance

PRG > 6(Tools) > 4(Resonant Avd.)

Operations can be conducted in a manner that avoids points of mechanical resonance. The inverter operates by jumping frequencies. Resonance prevention settings are set to accomplish this. Three resonance prevention points can be set, and the jump width can be set at one common point.

Return to previous screen Return to running

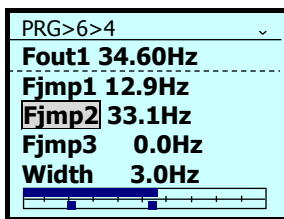
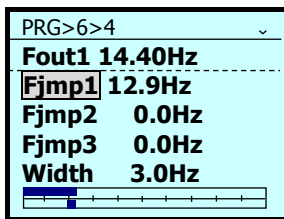
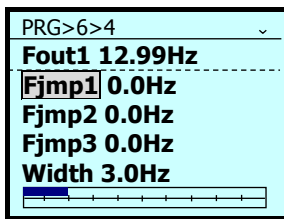
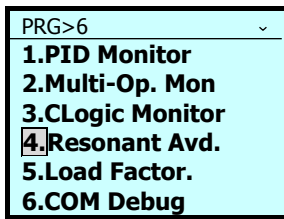
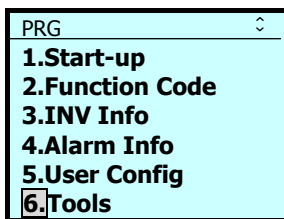
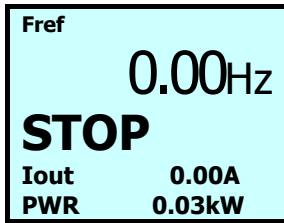

1. Press the key while the running mode screen is displayed.
2. Use the / keys to select [6. Tools], and confirm with the key.
3. Use the / keys to select [4. Resonant Avd.], and confirm with the key.
4. Operate with the run command ON.
5. Pressing the key at a point of resonance sets resonance prevention point 1 (Fjmp1).
Note: Pressing the key for a long period of time changes the width (jump width). (Consistent for Fjmp1-Fjmp3).
6. Using the key to move the cursor to Fjmp2 and pressing the key at the next point of resonance set resonance prevention point 2 (Fjmp2).
Note: Pressing the key for a long period of time changes the width (jump width). (Consistent for Fjmp1-Fjmp3).

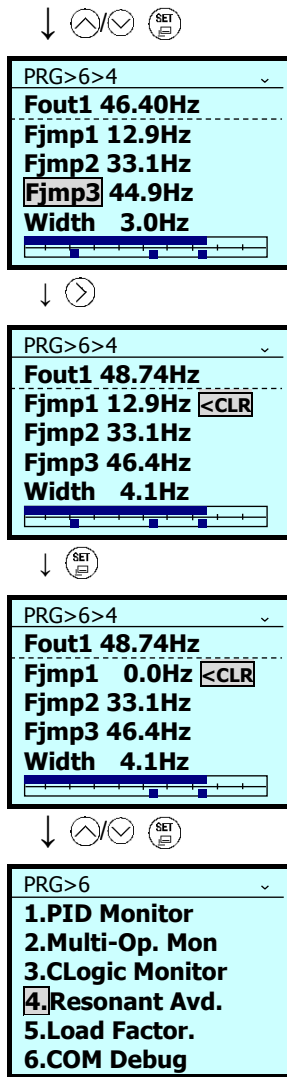

- Using the \downarrow key to move the cursor to Fjmp3 and pressing the SET key at the next point of resonance sets resonance prevention point 3 (Fjmp3).

Note: Pressing the SET key for a long period of time changes the width (jump width). (Consistent for Fjmp1-Fjmp3).

- Clear Fjmp1-Fjmp3, Width
With the cursor on Fjmp1, press the CLR key to display < CLR.

- Clear Fjmp1-Fjmp3 and Width
Press the SET key to clear the Fjmp1 value. With < CLR displayed, use the \uparrow / \downarrow keys to move the cursor to Fjmp2 and then press the SET key to clear the value. In the same way, clear Fjmp 3 and Width values.

- Use the RESET key to return to the menu screen.

5.6.7.5 Load Factor Measurement

PRG > 6(Tools) > 5(Load Factor)

Selecting "5. Load Factor Measurement" from the programming mode menu enables measurement of the maximum output current, average output current and average braking power. Measurement modes are indicated in the table below.

Measurement Mode	Details
Mode for measuring for a fixed period of time	Mode for setting a measurement period and taking measurements for a set period of time
Mode for measuring from run to stop	Mode for taking measurements from the beginning to the end of a run

Note If in the mode to measure the interval from run to stop, entering this mode while running will take measurements during the period until stopping. If entering this mode while stopped, measurements will be taken from the next run until the stop.

Tip During load factor measurement, the PRG key transitions into running mode. The SET key moves to the measurement mode selection screen. In this case, load factor measurement will be continued.

< Mode for measuring for a fixed period of time >

Return to previous screen Return to running

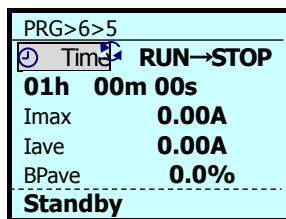
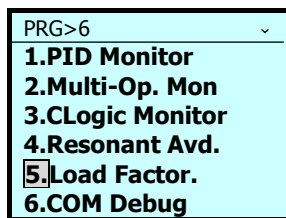
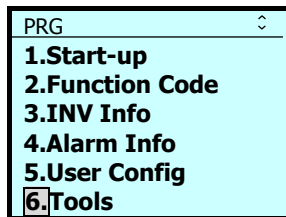
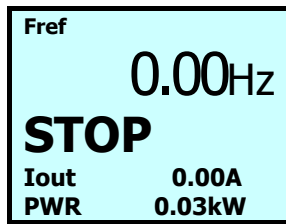

← Maximum output current
← Average output current
← Average braking power consumption

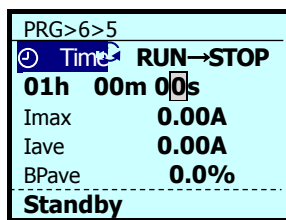

← <Initial setting value>
1 hour

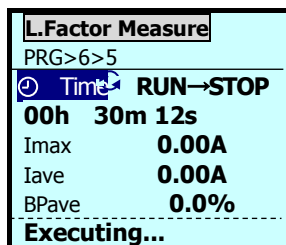

← Blinks while measuring

← Remaining measurement

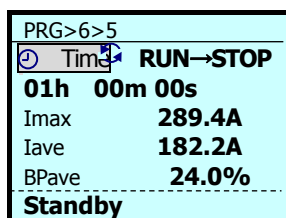

1. Press the key while the running mode screen is displayed.

2. Use the / keys to select [6. Tools], and confirm with the key.

3. Use the / keys to select [5. Load Factor], and confirm with the key.

4. On the mode selection screen, use the / to move the **Cursor**, and select "Time". Confirm with the key.

5. Shift with the / , and set the measurement time with the / keys. Use the key to start measurement.

Note: Pressing the key while measuring will cancel the measurement.

6. While measuring, the message "L. Factor Measure" blinks.

7. Measurement is concluded after the measurement time elapses, and measurement results are displayed.

< Mode for measuring from run to stop >

Return to previous screen Return to running

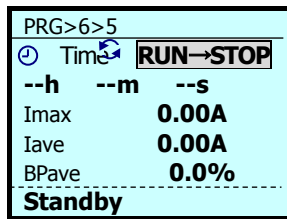
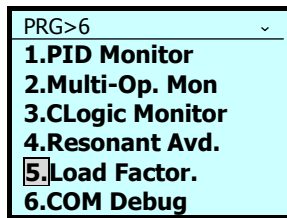
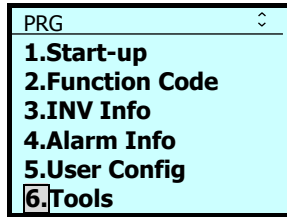
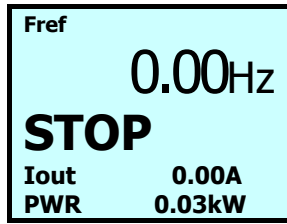

← Maximum output current
 ← Average output current
 ← Average braking power consumption

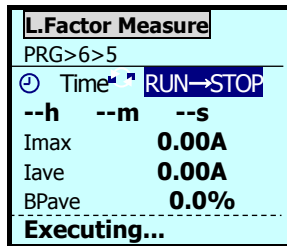
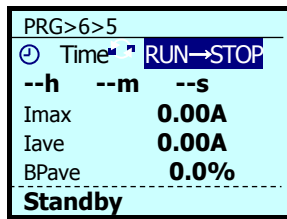

← Blinks while measuring

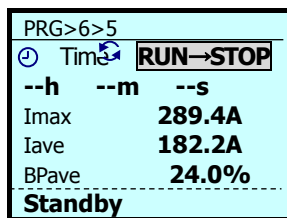

1. Press the key while the running mode screen is displayed.

2. Use the / keys to select [6. Tools], and confirm with the key.

3. Use the / keys to select [5. Load Factor], and confirm with the key.

4. On the mode selection screen, use the / keys to move the **Cursor**, and select "RUN→STOP". Confirm with the key.

5. Entering the run command causes measurement to start. If the run command has already been input, this screen is skipped.
 Note: Pressing the key while measuring will cancel the measurement.

6. While measuring, the message "L. Factor Measure" blinks.

7. Measurement is concluded after the measurement time elapses, and measurement results are displayed.

5.6.7.6 Communication Debug

PRG > 6(Tools) > 6(COM Debug)

Communication-specific function codes (S, M, W, W1, W2, W3, X, X1, Z) can be monitored and set.

Return to previous screen Return to running

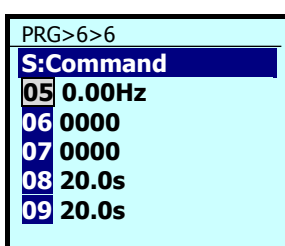
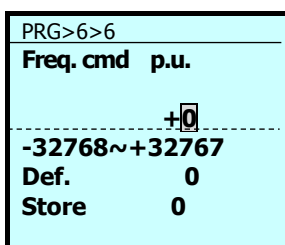
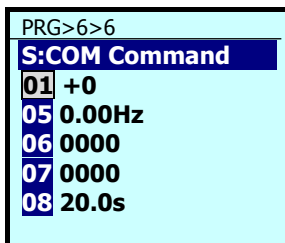
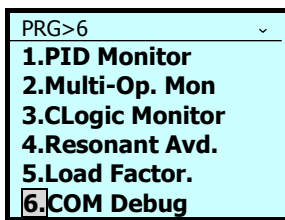
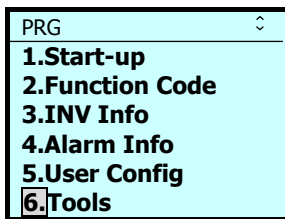
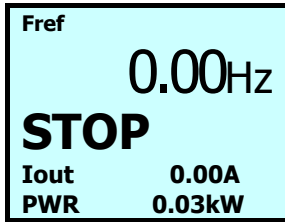

1. Press the key while the running mode screen is displayed.

2. Use the / keys to select [6. Tools], and confirm with the key.

3. Use the / keys to select [6. COM Debug], and confirm with the key.

5. On the mode selection screen, use the / keys to move the **Cursor**, and select the function code that you wish to set. Confirm with the key.



7. After changing the setting, confirm with the key.

8. The function code following the one that has been set is displayed.



5.7 Alarm Mode

If an abnormal condition arises, the protective function is invoked and issues an alarm, then the inverter automatically enters Alarm mode. At the same time, an alarm code appears on the LCD monitor.

5.7.1 Releasing the alarm and switching to Running mode



Remove the cause of the alarm and press the  key to release the alarm and return to Running mode. The alarm can be removed using the  key only when the alarm code is displayed.

5.7.2 Displaying the alarm history

It is possible to display 10 alarm codes (newest + past 9 alarms) in addition to the one currently displayed. Previous alarm codes can be displayed by pressing the  /  key while the current alarm code is displayed.

5.7.3 Displaying the status of inverter at the time of alarm

When the alarm code is displayed, you may check various running status information (output frequency and output current, etc.) by pressing the  key.

Further, you can view various pieces of information on the running status of the inverter using the  /  key. The information displayed is the same as for Menu #4 "Alarm Information" in Programming mode. Refer to Section 5.6.5.1, "Confirm Alarm History."

Pressing the  key while the running status information is displayed returns to the alarm code display.

5.7.4 Test run procedure

Make a test run of the motor using the flowchart given below.

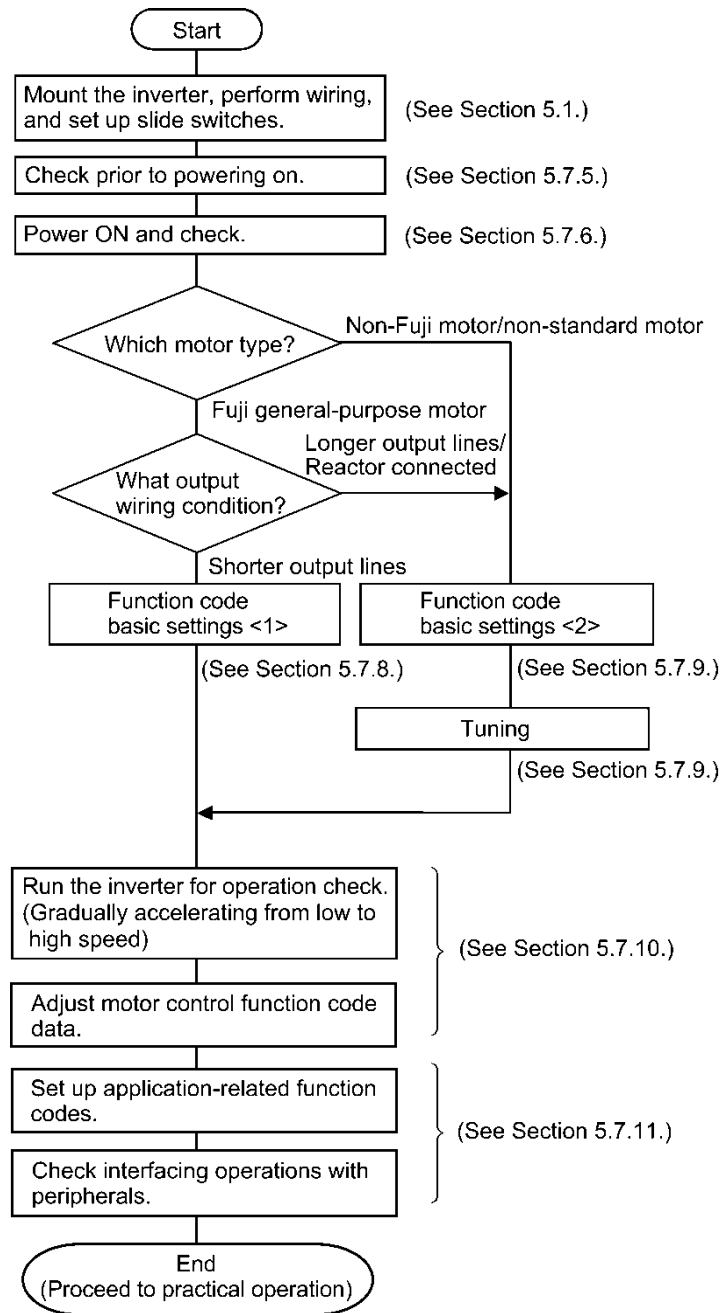

Figure 5.16 Test Run Procedure

5.7.5 Checking prior to powering ON

Check the following before powering on the inverter.

- (1) Check that the wiring is correct.

Especially check the wiring to the inverter input terminals L1/R, L2/S and L3/T and output terminals U, V, and W. Also check that the grounding wires are connected to the grounding terminals (⊕G) correctly. See Figure 5.17.

⚠ WARNING

- Never connect power supply wires to the inverter output terminals U, V, and W. Doing so and turning the power ON breaks the inverter.
 - Be sure to connect the grounding wires of the inverter and the motor to the ground electrodes.
- Otherwise, an electric shock could occur.**

- (2) Check the control circuit terminals and main circuit terminals for short circuits or ground faults.
- (3) Check for loose terminals, connectors and screws.
- (4) Check that the motor is separated from mechanical equipment.
- (5) Make sure that all switches of devices connected to the inverter are turned OFF. Powering on the inverter with any of those switches being ON may cause an unexpected motor operation.
- (6) Check that safety measures are taken against runaway of the equipment, e.g., a defense to prevent people from access to the equipment.

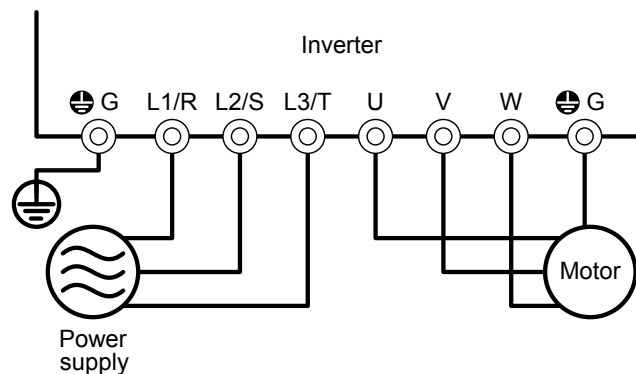

Figure 5.17 Connection of Main Circuit Terminals

5.7.6 Powering ON and checking

⚠ WARNING

- Be sure to mount the front cover before turning the power ON. Do not remove the cover when the inverter power is ON.
 - Do not operate switches with wet hands.
- Otherwise, an electric shock could occur.**

Turn the power ON and check the following points. The following is a case when no function code data is changed from the factory defaults.

- (1) Check that the LCD monitor displays 0.00 Hz (indicating that the reference frequency is 0 Hz) that is blinking. (See Figure 5.18.)

If the LCD monitor displays any number except 0.00 Hz, press the \uparrow / \downarrow key to set 0.00 Hz.

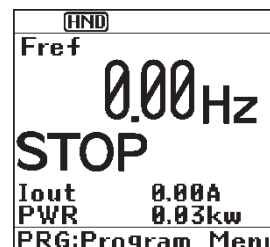

Figure 5.18 Display of the LCD Monitor after Power-on

5.7.7 Selecting a desired motor drive control

The FRENIC-HVAC supports the following motor drive control.

■ V/f control with slip compensation inactive

Under this control, the inverter controls a motor with the voltage and frequency according to the V/f pattern specified by function codes. This control disables all automatically controlled features such as the slip compensation, so no unpredictable output fluctuation results, enabling stable operation with constant output frequency.

■ V/f control with slip compensation active

Applying any load to an induction motor causes a rotational slip due to the motor characteristics, decreasing the motor rotation. The inverter's slip compensation function first presumes the slip value of the motor based on the motor torque generated and raises the output frequency to compensate for the decrease in motor rotation. This prevents the motor from decreasing the rotation due to the slip.

That is, this function is effective for improving the motor speed control accuracy.

The compensation value is specified by combination of function code P12 (Rated slip frequency).

H68 enables or disables the slip compensation function according to the motor driving conditions.

H68 data	Motor driving conditions		Motor driving frequency zone	
	Accel/Decel	Constant speed	Base frequency or below	Above the base frequency
0	Enable	Enable	Enable	Enable
1	Disable	Enable	Enable	Enable
2	Enable	Enable	Enable	Disable
3	Disable	Enable	Enable	Disable

■ Dynamic torque vector control

To get the maximal torque out of a motor, this control calculates the motor torque for the load applied and uses it to optimize the voltage and current vector output.

Selecting this control automatically enables the auto torque boost and slip compensation function.

This control is effective for improving the system response to external disturbances such as load fluctuations, and the motor speed control accuracy.

5.7.8 Function code basic settings < 1 >

Driving a Fuji general-purpose motor under the V/f control (F42 = 0 or 2) or dynamic torque vector control (F42 = 1) requires configuring the following basic function codes.

Select any of the Fuji standard 8-series, HP motor typical model and others with the function code P99.

Configure the function codes listed below according to the motor ratings and your machinery design values. For the motor ratings, check the ratings printed on the motor's nameplate. For your machinery design values, ask system designers about them.

 For details on how to modify the function code data, see Section 5.6.3.1 "Setting up function codes."

Function code	Name	Function code data	Factory default
F04	Base frequency 1	Motor ratings (printed on the nameplate of the motor)	60.0 (Hz)
F05	Rated voltage at base frequency 1		230/460/575 V class series 230/460/575 (V)
P99	Motor 1 selection	0: Motor characteristics 0 (Fuji standard motors, 8-series) 1: Motor characteristics 1 (HP rating motors) 4: Other motors	1 (HP rating motors)
P02	Motor 1 (Rated capacity)	Capacity of motor connected	Nominal applied motor capacity
F03	Maximum frequency 1	Machinery design values (Note) For a test-driving of the motor, increase values so that they are longer than your machinery design values. If the specified time is short, the inverter may not run the motor properly.	60.0 (Hz)
F07	Acceleration time 1 (Note)		20.00 (s)
F08	Deceleration time 1 (Note)		20.00 (s)



When accessing the function code P02, take into account that changing the P02* data automatically updates the data of the function codes P03, P06 to P08, P10, P12, and H46.

The motor rating should be specified properly when performing auto-torque boost, torque calculation monitoring, auto energy saving, torque limiting, automatic deceleration (anti-regenerative control), auto search for idling motor speed, or slip compensation.

In any of the following cases, the full control performance may not be obtained from the inverter because the motor parameters differ from the factory defaults, so perform auto-tuning.

- The motor to be driven is not a Fuji product or is a non-standard product.
- The wiring distance between the inverter and the motor is too long (generally 20 m or more).
- A reactor is inserted between the inverter and the motor.

 Refer to Section 5.7.9 "Function code basic settings and tuning < 2 >."

5.7.9 Function code basic settings and tuning < 2 >

Under the V/f control (F42 = 0 or 2) or dynamic torque vector control (F42 = 1), any of the following cases requires configuring the basic function codes given below and auto-tuning.

- Driving a non-Fuji motor or non-standard motor
- Driving a Fuji general-purpose motor, provided that the wiring distance between the inverter and motor is long or a reactor is connected

Configure the function codes listed below according to the motor ratings and your machinery design values. For the motor ratings, check the ratings printed on the motor's nameplate. For your machinery design values, ask system designers about them.

 For details on how to modify the function code data, see Section 5.6.3.1 "Setting up function codes."

Function code	Name	Function code data	Factory default
F04	Base frequency 1	Motor ratings (printed on the nameplate of the motor)	60.0 (Hz)
F05	Rated voltage at base frequency 1		230/460/575 V class series 230/460/575 (V)
P02	Motor 1 (Rated capacity)		Nominal applied motor capacity
P03	Motor 1 (Rated current)		Rated current of nominal applied motor
F03	Maximum frequency 1	Machinery design values (Note) For a test-driving of the motor, increase values so that they are longer than your machinery design values. If the specified time is short, the inverter may not run the motor properly.	60.0 (Hz)
F07	Acceleration time 1 (Note)		20.00 (s)
F08	Deceleration time 1 (Note)		20.00 (s)

 **Note** When accessing the function code P02, take into account that changing the P02* data automatically updates the data of the function codes P03, P06 to P08, and H46.

■ Tuning procedure

(1) Selection of tuning type

Check the situation of the machinery and select "Tuning with the motor stopped (P04 = 1)" or "Tuning with the motor running (P04 = 2)." For the latter tuning, adjust the acceleration and deceleration times (F07 and F08) and specify the rotation direction that matches the actual rotation direction of the machinery.

P04 data	Tuning type	Motor parameters subjected to tuning	Tuning	Select under the following conditions
1	Tune while the motor stops	Primary resistance (%R1) (P07) Leakage reactance (%X) (P08)	Tuning <u>with the motor stopped</u> .	Cannot rotate the motor.
2	Tune while the motor is rotating under V/f control	No-load current (P06) Primary resistance (%R1) (P07) Leakage reactance (%X) (P08)	Tuning the %R1 and %X, <u>with the motor stopped</u> . Tuning the no-load current, <u>with the motor running</u> at 50% of the base frequency.	Can rotate the motor, provided that it is safe. Note that little load should be applied during tuning. Tuning with load applied decreases the tuning accuracy.

The tuning results of motor parameters will be automatically saved into their respective function codes. If P04 tuning is performed, for instance, the tuning results will be saved into P codes (Motor parameters).

(2) Preparation of machinery

Perform appropriate preparations on the motor and its load, such as disengaging the coupling from the motor and deactivating the safety devices.

(3) Tuning

- ① Set function code P04 to "1" or "2" and press the  key. (Blinking of 1 or 2 will slow down.)
- ② Enter a run command.
- ③ The moment a run command is entered, the display of 1 or 2 lights up, and tuning starts with the motor stopped.
(Maximum tuning time: Approx. 40 to 80 s.)
- ④ If P04 = 2, after the tuning in ③ above, the motor is accelerated to approximately 50% of the base frequency and then tuning starts. Upon completion of measurements, the motor decelerates to a stop.
(Estimated tuning time: Acceleration time + 20 to 75 s + Deceleration time)
- ⑤ If P04 = 2, after the motor decelerates to a stop in ④ above, tuning continues with the motor stopped.
(Maximum tuning time: Approx. 40 to 80 s.)
- ⑥ If the terminal signal **FWD** or **REV** is selected as a run command (F02 = 1), turning the run command OFF after completion of measurement completes the tuning.
If the run command has been given through the keypad or the communications link, it automatically turns OFF upon completion of the measurements, which completes the tuning.
- ⑦ Upon completion of the tuning, the subsequent function code P04 appears on the keypad.

■ Tuning errors

Improper tuning would negatively affect the operation performance and, in the worst case, could even cause hunting or deteriorate precision. Therefore, if the inverter finds any abnormality in the tuning results or any error in the tuning process, it displays Er7 and discards the tuning data.

Listed below are possible causes that trigger tuning errors.

Possible tuning error causes	Details
Error in tuning results	<ul style="list-style-type: none"> - An interphase voltage unbalance or output phase loss has been detected. - Tuning has resulted in an abnormally high or low value of a parameter due to the output circuit opened.
Output current error	An abnormally high current has flown during tuning.
Sequence error	During tuning, a run command has been turned OFF, or STOP (Force to stop), BX (Coast to a stop), DWP (Protect from dew condensation), or other similar terminal command has been received.
Error due to limitation	<ul style="list-style-type: none"> - During tuning, any of the operation limiters has been activated. - The maximum frequency or the frequency limiter (high) has limited tuning operation.
Other errors	An undervoltage or any other alarm has occurred.

If any of these errors occurs, remove the error cause and perform tuning again, or consult your Fuji Electric representative.

Note If a filter other than the Fuji optional output filter (OFL-□□□-□A) is connected to the inverter's output (secondary) circuit, the tuning result cannot be assured. When replacing the inverter connected with such a filter, make a note of the old inverter's settings for the primary resistance %R1, leakage reactance %X, no-load current, and rated slip frequency, and specify those values to the new inverter's function codes.

Vibration that may occur when the motor's coupling is elastic can be regarded as normal vibration due to the output voltage pattern applied in tuning. The tuning does not always result in an error; however, run the motor and check its running state.

5.7.10 Running the inverter for motor operation check

⚠ WARNING

If the user configures the function codes wrongly without completely understanding this Instruction Manual and the FRENIC-HVAC User's Manual, the motor may rotate with a torque or at a speed not permitted for the machine.

Accident or injury may result.

After completion of preparations for a test run as described above, start running the inverter for motor operation check using the following procedure.

⚠ CAUTION

If any abnormality is found in the inverter or motor, immediately stop operation and investigate the cause referring to Chapter 9, "TROUBLESHOOTING."

----- Test Run Procedure -----

- (1) Turn the power ON and check that the reference frequency 0.00 Hz is blinking on the LCD monitor.
- (2) Set a low reference frequency such as 5 Hz, using \wedge / \vee keys. (Check that the frequency is blinking on the LCD monitor.)
- (3) Press the FWD key to start running the motor in the forward direction. (Check that the reference frequency is displayed on the LCD monitor.)
- (4) To stop the motor, press the STOP key.

< Check points during a test run >

- Check that the motor is running in the forward direction.
- Check for smooth rotation without motor humming or excessive vibration.
- Check for smooth acceleration and deceleration.

When no abnormality is found, press the FWD key again to start driving the motor, then increase the reference frequency using \wedge / \vee keys. Check the above points again.

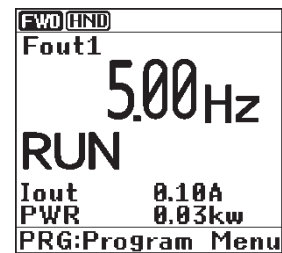

< Modification of motor control function code data >

Modifying the current function code data sometimes can solve an insufficient torque or overcurrent incident. The table below lists the major function codes to be accessed. For details, see Chapter 6 "FUNCTION CODES" and Chapter 9 "TROUBLESHOOTING."

Function code	Name	Modification key points
F07	Acceleration Time 1	If the current limiter is activated due to a short acceleration time and large drive current, prolong the acceleration time.
F08	Deceleration Time 1	If an overvoltage trip occurs due to a short deceleration time, prolong the deceleration time.
F09	Torque Boost 1	If the starting motor torque is deficient, increase the torque boost. If the motor with no load is overexcited, decrease the torque boost.

< Remedy to be taken if an alarm ECF (Enable circuit failure) occurs >

Possible Causes	What to Check and Suggested Measures
(1) Poor connection of interface PCB	Check that the interface printed circuit board (PCB) is firmly connected to the inverter unit. Restarting the inverter releases the alarm.
(2) Enable circuit logic error	Check that the logic values of the output of safety switches match with each other (EN1/EN2 = High/High or Low/Low). Restarting the inverter releases the alarm.
(3) Enable circuit (safety circuit) failure detected	If this error persists after the above procedures have been taken, the inverter is defective. Consult your Fuji Electric representative. (The alarm cannot be released.)

5.7.11 Preparation for practical operation

After verifying normal motor running with the inverter in a test run, connect the motor with the machinery and perform wiring for practical operation.

- (1) Configure the application related function codes that operate the machinery.
- (2) Check interfacing with the peripheral circuits. Turn the power ON and check that the reference frequency 0.00 Hz is blinking on the LCD monitor.
 - 1) Mock alarm

Generate a mock alarm by pressing the " +  keys" on the keypad for 5 seconds or more and check the alarm sequence. The inverter should stop and issue an alarm output signal (for any fault).
 - 2) Judgment on the life of the DC link bus capacitor

When the multi-function keypad is used, it is necessary to set up the judgment reference level to be applied for the judgment on the life of the DC link bus capacitor.

When the remote keypad is used, the same setting-up is also necessary in order to judge the life of the DC link bus capacitor under the practical operating conditions.

For details, refer to Chapter 10.
 - 3) I/O checking

Check interfacing with peripherals by checking I/O on (PRG) > 3 (INV Info) > 3 (I/O Check) on the keypad in Programming mode. For details, refer to Chapter 5.
 - 4) Analog input adjustment

Adjust the analog inputs on terminals [12], [C1] and [V2] using the function codes related to the offset, filter and gain that minimize analog input errors. For details, refer to Chapter 6.

5) Calibrating the [FM1] / [FM2] output

Calibrate the full scale of the analog meter connected to the terminals [FM1] and [FM2], using the reference voltage equivalent to +10 VDC or current equivalent to 20 mA. To output the reference voltage, it is necessary to select the analog output test with the function code (F31/F35 = 14).

6) Clearing the alarm history

Clear the alarm history saved during the system setup with the function code (H97 = 1).

 Depending upon the situation of the practical operation, it may become necessary to modify the settings of the torque boost (F09) and acceleration/deceleration times (F07/F08). Confirm the function code data and modify them properly.

 The inverter is available in either remote or local mode.

- Remote mode: The inverter is driven by terminal commands, via the communications link or from the keypad which are selectable with function codes.
- Local mode: The inverter is separated from the system and driven by keypad operation. This mode is convenient for test-run and maintenance.

 For details, refer to Section 5.5.4 "Remote and local modes."

Chapter 6

FUNCTION CODES

This chapter contains overview tables of function codes available for the FRENIC-HVAC series of inverters and details of function codes.

Contents

6.1	Overview of Function Codes	6-1
6.2	Function Code Tables.....	6-2
6.3	Details of Function Codes.....	6-41
6.3.1	F codes (Fundamental functions).....	6-41
6.3.2	E codes (Extension terminal functions).....	6-84
6.3.3	C codes (Control functions).....	6-125
6.3.4	P codes (Motor 1 parameters)	6-137
6.3.5	H codes (High performance functions)	6-141
6.3.6	H1 codes (High performance functions).....	6-174
6.3.7	J codes (Application functions 1).....	6-181
6.3.8	J1 codes (PID control 1).....	6-182
6.3.9	J2 codes (PID control 2).....	6-215
6.3.10	J5 codes (External PID control 1)	6-217
6.3.11	J6 codes (External PID control 2, 3)	6-245
6.3.12	d codes (Application functions 2)	6-249
6.3.13	U codes (Customizable logic functions)	6-249
6.3.14	U1 codes (Customizable logic functions)	6-270
6.3.15	y codes (Link functions).....	6-275
6.3.16	T codes (Timer functions)	6-280
6.3.17	K codes (Keypad functions).....	6-284

6.1 Overview of Function Codes

Function codes enable the FRENIC-HVAC series of inverters to be set up to match your system requirements.

The function codes are classified into these groups: Fundamental Functions (F codes), Extension Terminal Functions (E codes), Control Functions (C codes), Motor 1 Parameters (P codes), High Performance Functions (H and H1 codes), Application Functions 1 (J codes), PID Control 1 (J1 codes), PID Control 2 (J2 codes), External PID Control 1 (J5 codes), External PID Control 2 and 3 (J6 codes), Application Functions 2 (d codes), Customizable Logic Functions (U and U1 codes), Link Functions (y codes), Timer Operation Functions (T codes), Keypad Functions (K codes), and Option Functions (o codes). To determine the property of each function code, set data to the function code.

This manual does not contain the descriptions of Option Functions (o codes). For o codes, refer to the instruction manual for each option.

6.2 Function Code Tables

The following descriptions supplement those given in the function code tables on page 6-3 and subsequent pages.

■ Changing, validating, and saving function code data when the inverter is running

Function codes are indicated by the following based on whether they can be changed or not when the inverter is running:

Notation	Change when running	Validating and saving function code data
Y*	Possible	If the data of the codes marked with Y* is changed with \uparrow / \downarrow / \leftarrow / \rightarrow keys, the change will immediately take effect; however, the change is not saved into the inverter's memory. To save the change, press the SET key. If you press the PRG key without pressing the SET key to exit the current state, then the changed data will be discarded and the previous data will take effect for the inverter operation.
Y	Possible	Even if the data of the codes marked with Y is changed with \uparrow / \downarrow / \leftarrow / \rightarrow keys, the change will not take effect. Pressing the SET key will make the change take effect and save it into the inverter's memory.
N	Impossible	—

■ Copying data

The keypad is capable of copying the function code data stored in the inverter's memory into the keypad's memory ($\text{PRG} > 2(\text{Function Code}) > 4(\text{Data Copy})$). With this feature, you can easily transfer the data saved in a source inverter to other destination inverters.

If the specifications of the source and destination inverters differ, some code data may not be copied to ensure safe operation of your power system. Whether data will be copied or not is detailed with the following symbols in the "Data copying" column of the function code tables given on page 6-3 and subsequent pages.

Y: Will be copied unconditionally.

Y1: Will not be copied if the rated capacity differs from the source inverter.

N: Will not be copied. (The function code marked with "N" is not subject to the Verify operation, either.)

■ Using negative logic for programmable I/O terminals

The negative logic signaling system can be used for the programmable, digital input and output terminals by setting the function code data specifying the properties for those terminals. Negative logic refers to the inverted ON/OFF (logical value 1 (true)/0 (false)) state of input or output signal. An active-ON signal (the function takes effect if the terminal is short-circuited.) in the normal logic system is functionally equivalent to active-OFF signal (the function takes effect if the terminal is opened.) in the negative logic system. Active-ON signals can be switched to active-OFF signals, and vice versa, with the function code data setting, except some signals.

To set the negative logic system for an input or output terminal, enter data of 1000s (by adding 1000 to the data for the normal logic) in the corresponding function code.

Example: "Coast to a stop" command **BX** assigned to any of digital input terminals [X1] to [X7] using any of function codes E01 through E07.

Function code data	Description
7	Turning BX ON causes the motor to coast to a stop. (Active-ON)
1007	Turning BX OFF causes the motor to coast to a stop. (Active-OFF)

The following tables list the function codes available for the FRENIC-HVAC series of inverters.

F codes: Fundamental Functions

Code	Name	Data setting range	Change when running	Data copying	Default setting	Related page
F00	Data Protection	0: Disable both data protection and digital reference protection 1: Enable data protection and disable digital reference protection 2: Disable data protection and enable digital reference protection 3: Enable both data protection and digital reference protection	Y	Y	0	6-41
F01	Frequency Command 1	0: / / / keys on keypad 1: Voltage input to terminal [12] (-10 to +10 VDC) 2: Current input to terminal [C1] (4 to 20 mA DC) 3: Sum of voltage and current inputs to terminals [12] and [C1] 5: Voltage input to terminal [V2] (0 to 10 VDC) 7: Terminal command UP/DOWN control 8: / / / keys on keypad (balanceless-bumpless switching available) 10: Pattern operation	N	Y	0	6-42
F02	Operation Method	0: FWD/REV/STOP keys on keypad (Motor rotational direction specified by terminal command FWD/REV) 1: External signals (Terminal command FWD or REV) 2: FWD/STOP keys on keypad (forward) 3: REV/STOP keys on keypad (reverse)	N	Y	0	6-49
F03	Maximum Frequency 1	25.0 to 120.0 Hz	N	Y	60.0	6-50
F04	Base Frequency 1	25.0 to 120.0 Hz	N	Y	60.0	
F05	Rated Voltage at Base Frequency 1	OFF: Disable AVR (Output a voltage in proportion to input voltage) 80-240 V: Output an AVR-controlled voltage (230 V class series) 160-500 V: Output an AVR-controlled voltage (460 V class series) 200-600 V: Output an AVR-controlled voltage (575 V class series)	N	Y	230 460 575	
F06	Maximum Output Voltage 1	80-240 V: Output an AVR-controlled voltage (230 V class series) 160-500 V: Output an AVR-controlled voltage (460 V class series) 200-600 V: Output an AVR-controlled voltage (575 V class series)	N	Y		
F07	Acceleration Time 1	0.00 to 3600.00 s	Y	Y	20.00	6-53
F08	Deceleration Time 1	Note: Entering 0.00 cancels the acceleration time, requiring external soft-start.	Y	Y	20.00	
F09	Torque Boost 1	0.0% to 20.0% (percentage with respect to "F05: Rated Voltage at Base Frequency 1")	Y	Y	0.0	6-55
F10	Electronic Thermal Overload Protection for Motor 1 (Select motor characteristics)	1: For a general-purpose motor with shaft-driven cooling fan 2: For an inverter-driven motor, non-ventilated motor, or motor with separately powered cooling fan	Y	Y	1	6-59
F11	(Overload detection level)	OFF: Disable 1% to 135% of the inverter rated current	Y	Y1	*2	
F12	(Thermal time constant)	0.5 to 75.0 min	Y	Y	*3	
F14	Restart Mode after Momentary Power Failure (Mode selection)	0: Trip immediately 1: Trip after a recovery from power failure 3: Continue to run, for heavy inertia or general loads 4: Restart at the frequency at which the power failure occurred, for general loads 5: Restart at the starting frequency	Y	Y	0	6-59
F15	Frequency Limiter (High)	0.0 to 120.0 Hz	Y	Y	70.0	6-66
F16	(Low)	0.0 to 120.0 Hz	Y	Y	0.0	
F18	Bias (Frequency command 1)	-100.00% to 100.00%	Y*	Y	0.00	6-67
F20	DC Braking 1 (Braking starting frequency)	0.0 to 60.0 Hz	Y	Y	0.0	
F21	(Braking level)	0% to 60% on the basis of inverter rated current	Y	Y	0	
F22	(Braking time)	OFF (Disable); 0.01 to 30.00 s	Y	Y	OFF	
F23	Starting Frequency 1	0.1 to 60.0 Hz	Y	Y	0.5	
F24	(Holding time)	0.00 to 10.00 s	Y	Y	0.00	6-69
F25	Stop Frequency	0.1 to 60.0 Hz	Y	Y	0.2	

The shaded function codes () are applicable to the quick setup.

*2 The motor rated current is automatically set. See Table B (function code P03).

*3 5.0 min for inverters of 30 HP or below; 10.0 min for those of 40 HP or above.

Code	Name	Data setting range	Change when running	Data copying	Default setting	Related page
F26	Motor Sound (Carrier frequency)	230 V class series 0.75 to 16 kHz (1 to 25 HP) 0.75 to 10 kHz (30 to 100 HP) 0.75 to 6 kHz (125 HP) 460 V class series 0.75 to 16 kHz (1 to 50 HP) 0.75 to 10 kHz (60 to 125 HP) 0.75 to 6 kHz (150 to 900 HP) 0.75 to 4 kHz (1000 HP) 575 V class series 0.75 to 16 kHz (1 to 50 HP) 0.75 to 10 kHz (60 to 125HP) 0.75 to 6 kHz (150 to 300 HP)	Y	Y	2	6-70
F27	(Tone)	0: Level 0 (Inactive) 1: Level 1 2: Level 2 3: Level 3	Y	Y	0	
F29	Analog Output [FM1] (Mode selection)	0: Output in voltage (0 to 10 VDC) 1: Output in current (4 to 20 mA DC) 2: Output in current (0 to 20 mA DC)	Y	Y	0	6-71
F30	(Voltage adjustment)	0% to 300%	Y*	Y	100	
F31	Analog Output [FM1] (Function)	Select a function to be monitored from the followings. 0: Output frequency 1 (before slip compensation) 1: Output frequency 2 (after slip compensation) 2: Output current 3: Output voltage 4: Output torque 5: Load factor 6: Input power 7: PID feedback amount 9: DC link bus voltage 10: Universal AO 13: Motor output 14: Calibration (+) 15: PID command (SV) 16: PID output (MV) 18: Inverter heat sink temperature (200°C/10 V) 20: Reference frequency 50: PID feedback amount 1 (PV1) 51: PID command 1 (SV1) 52: PID deviation 1 (ERR1) (Note 1) 53: PID final deviation (ERR) (Note 1) 54: PID feedback amount 2 (PV2) 55: PID command 2 (SV2) 56: PID deviation 2 (ERR2) (Note 1) 60: External PID feedback amount 1 (EPID1-PV) 61: External PID command 1 (EPID1-SV) 62: External PID deviation 1 (EPID1-ERR) (Note 1) 63: External PID final deviation 1 (EPID1-ERR) (Note 1) 65: External PID final output 1 (EPID1-OUT) 70: External PID feedback amount 2 (EPID2-PV) 71: External PID command 2 (EPID2-SV) 72: External PID deviation 2 (EPID2-ERR) (Note 1) 75: External PID final output 2 (EPID2-OUT) 80: External PID feedback amount 3 (EPID3-PV) 81: External PID command 3 (EPID3-SV) 82: External PID deviation 3 (EPID3-ERR) (Note 1) 85: External PID final output 3 (EPID3-OUT) 111: Customizable logic output signal 1 112: Customizable logic output signal 2 113: Customizable logic output signal 3 114: Customizable logic output signal 4 115: Customizable logic output signal 5 116: Customizable logic output signal 6 117: Customizable logic output signal 7 (Note 1) Deviation output is supported only by option terminal [Ao] (o09).	Y	Y	0	
F32	Pulse Output [FM2] (Mode selection)	0: Voltage (0 to +10 VDC) 1: Current (4 to +20 mA DC) 2: Current (0 to +20 mA DC)	Y	Y	0	6-74
F34	(Voltage adjustment)	0 to 300%	Y*	Y	0	
F35	(Function)	Same as F31.	Y	Y	0	
F37	Load Selection/ Auto Torque Boost/ Auto Energy Saving Operation 1	0: Variable torque load 1: Constant torque load 2: Auto torque boost 3: Auto energy saving (Variable torque load during ACC/DEC) 4: Auto energy saving (Constant torque load during ACC/DEC) 5: Auto energy saving (Auto torque boost during ACC/DEC)	N	Y	1	6-75
F40	Torque Limiter 1 (Driving)	OFF: Disable	Y	Y	OFF	6-78
F41	(Braking)	20% to 150%: Torque limiter level				
F42	Drive Control Selection 1	0: V/f control with slip compensation inactive 1: Dynamic torque vector control 2: V/f control with slip compensation active	N	Y	0	6-80
F43	Current Limiter (Mode selection)	0: Disable (No current limiter works.) 1: Enable at constant speed (Disable during ACC/DEC) 2: Enable during ACC/constant speed operation	Y	Y	2	6-82
F44	(Level)	20% to 120% (Assuming the inverter rated current as 100%.)	Y	Y	120	

E codes: Extension Terminal Functions

Code	Name	Data setting range	Change when running	Data copying	Default setting	Related page
E01	Terminal [X1] Function	Selecting function code data assigns the corresponding function to terminals [X1] to [X7] as listed below.	N	Y	0	6-84
E02	Terminal [X2] Function	0 (1000): Select multistep frequency (0 to 1 steps) (SS1)	N	Y	1	
E03	Terminal [X3] Function	1 (1001): Select multistep frequency (0 to 3 steps) (SS2)	N	Y	6	
E04	Terminal [X4] Function	2 (1002): Select multistep frequency (0 to 7 steps) (SS4)	N	Y	7	
E05	Terminal [X5] Function	3 (1003): Select multistep frequency (0 to 15 steps) (SS8)	N	Y	8	
E06	Terminal [X6] Function	4 (1004): Select ACC/DEC time (2 steps) (RT1)	N	Y	11	
E07	Terminal [X7] Function	5 (1005): Select ACC/DEC time (4 steps) (RT2)	N	Y	35	
		6 (1006): Enable 3-wire operation (HLD)	N	Y		
		7 (1007): Coast to a stop (BX)				
		8 (1008): Reset alarm (RST)				
		9 (1009): Enable external alarm trip (9 = Active OFF, 1009 = Active ON) (THR)				
		11 (1011): Select frequency command 2/1 (Hz2/Hz1) (Hz2/Hz1)				
		13: Enable DC braking (DCBRK) (DCBRK)				
		14 (1014): Select torque limiter level 2/1 (TL2/TL1) (TL2/TL1)				
		15: Switch to commercial power (50 Hz) (SW50) (SW50)				
		16: Switch to commercial power (60 Hz) (SW60) (SW60)				
		17 (1017): UP (Increase output frequency) (UP) (UP)				
		18 (1018): DOWN (Decrease output frequency) (DOWN) (DOWN)				
		19 (1019): Enable data change with keypad (WE-KP) (WE-KP)				
		20 (1020): Cancel PID control (Hz/PID) (Hz/PID)				
		21 (1021): Switch normal/inverse operation (IVS) (IVS)				
		22 (1022): Interlock (IL) (IL)				
		24 (1024): Enable communications link via RS-485 or fieldbus (option) (LE) (LE)				
		25 (1025): Universal DI (U-DI) (U-DI)				
		26 (1026): Enable auto search for idling motor speed at starting (STM) (STM)				
		30 (1030): Force to stop (30 = Active OFF, 1030 = Active ON) (STOP) (STOP)				
		33 (1033): Reset PID integral and differential components (PID-RST) (PID-RST)				
		34 (1034): Hold PID integral component (PID-HLD) (PID-HLD)				
		35 (1035): Select local (keypad) operation (LOC) (LOC)				
		38 (1038): Enable run commands (RE) (RE)				
		39: Protect motor from dew condensation (DWP) (DWP)				
		40: Enable integrated sequence to switch to commercial power (50 Hz) (ISW50) (ISW50)				
		41: Enable integrated sequence to switch to commercial power (60 Hz) (ISW60) (ISW60)				
		58 (1058): Reset UP/DOWN frequency (STZ) (STZ)				
		72 (1072): Count the run time of commercial power-driven motor 1 (CRUN-M1) (CRUN-M1)				
		80 (1080): Cancel customizable logic (CLC) (CLC)				
		81 (1081): Clear all customizable logic timers (CLTC) (CLTC)				
		87 (1087): Run command 2/1 (FR2/FR1) (FR2/FR1)				
		88: Run forward 2 (FWD2) (FWD2)				
		89: Run reverse 2 (REV2) (REV2)				
		100: No function assigned (NONE) (NONE)				
		131 (1131): Flowrate switch (FS)* (FS)*				
		132 (1132): Filter clogging reverse rotation command (FRC) (FRC)				
		133 (1133): Switch PID channel (PID2/1) (PID2/1)				
		134: Switch to fire mode (FMS) (FMS)				
		171 (1171): PID multistep command 1 (PID-SS1) (PID-SS1)				
		172 (1172): PID multistep command 2 (PID-SS2) (PID-SS2)				
		181 (1181): External PID multistep command (EPID-SS1) (EPID-SS1)				
		182 (1182): External PID multistep command (EPID-SS2) (EPID-SS2)				
		190 (1190): Cancel timer (TMC) (TMC)				
		191 (1191): Enable timer 1 (TM1) (TM1)				
		192 (1192): Enable timer 2 (TM2) (TM2)				
		193 (1193): Enable timer 3 (TM3) (TM3)				
		194 (1194): Enable timer 4 (TM4) (TM4)				
		201 (1201): External PID control 1 ON command (EPID1-ON) (EPID1-ON)				
		202 (1202): Cancel external PID control 1 (%/EPID1) (%/EPID1)				
		203 (1203): Switch normal/inverse operation under external PID control 1 (EPID1-IVS) (EPID1-IVS)				
		204 (1204): Reset external PID1 integral and differential components (EPID1-RST) (EPID1-RST)				
		205 (1205): Hold external PID1 integral component (EPID1-HLD) (EPID1-HLD)				
		211 (1211): External PID control 2 ON command (EPID2-ON) (EPID2-ON)				
		212 (1212): Cancel external PID control 2 (%/EPID2) (%/EPID2)				
		213 (1213): Switch normal/inverse operation under external PID control 2 (EPID2-IVS) (EPID2-IVS)				
		214 (1214): Reset external PID2 integral and differential components (EPID2-RST) (EPID2-RST)				
		215 (1215): Hold external PID2 integral component (EPID2-HLD) (EPID2-HLD)				

* Available in the ROM version 1500 or later.

Code	Name	Data setting range	Change when running	Data copying	Default setting	Related page
		221 (1221): External PID control 3 ON command (EPID3-ON) 222 (1222): Cancel external PID control 3 (%/EPID3) 223 (1223): Switch normal/inverse operation under external PID control 3 (EPID3-IVS) 224 (1224): Reset external PID3 integral and differential components (EPID3-RST) 225 (1225): Hold external PID3 integral component (EPID3-HLD) Setting the value in parentheses () shown above assigns a negative logic output to a terminal. (True if OFF.) Setting the value of 1000s in parentheses () shown above assigns a negative logic input to a terminal.				6-84
E10	Acceleration Time 2	0.00 to 3600.00 s	Y	Y	20.00	6-105
E11	Deceleration Time 2	Note: Entering 0.00 cancels the acceleration time, requiring external soft-start and -stop.	Y	Y	20.00	
E12	Acceleration Time 3		Y	Y	20.00	
E13	Deceleration Time 3		Y	Y	20.00	
E14	Acceleration Time 4		Y	Y	20.00	
E15	Deceleration Time 4		Y	Y	20.00	
E16	Torque Limiter 2 (Driving)		OFF: Disable	Y	Y	OFF
E17	(Braking)	20% to 150%: Torque limiter level	Y	Y	OFF	
E20	Terminal [Y1] Function	Selecting function code data assigns the corresponding function to terminals [Y1] to [Y5A/C] and [30A/B/C] as listed below.	N	Y	0	6-106
E21	Terminal [Y2] Function	0 (1000): Inverter running (RUN)	N	Y	1	
E22	Terminal [Y3] Function	1 (1001): Frequency (speed) arrival signal (FAR)	N	Y	2	
E23	Terminal [Y4] Function	2 (1002): Frequency (speed) detected (FDT)	N	Y	7	
E24	Terminal [Y5A/C] Function	3 (1003): Undervoltage detected (Inverter stopped) (LU)	N	Y	15	
E27	Terminal [30A/B/C] Function (Relay output)	5 (1005): Inverter output limiting (IOL)	N	Y	99	
		6 (1006): Auto-restarting after momentary power failure (IPF)				
		7 (1007): Motor overload early warning (OL)				
		10 (1010): Inverter ready to run (RDY)				
		11: Switch motor drive source between commercial power and inverter output (For MC on commercial line) (SW88)				
		12: Switch motor drive source between commercial power and inverter output (For secondary side) (SW52-2)				
		13: Switch motor drive source between commercial power and inverter output (For primary side) (SW52-1)				
		15 (1015): Select AX terminal function (For MC on primary side) (AX)				
		16 (1016): Shifted to pattern operation stage (TU)				
		17 (1017): Pattern operation cycle completed (TO)				
		18 (1018): Pattern operation stage number (STG1)				
		19 (1019): Pattern operation stage number (STG2)				
		20 (1020): Pattern operation stage number (STG4)				
		22 (1022): Inverter output limiting with delay (IOL2)				
		25 (1025): Cooling fan in operation (FAN)				
		26 (1026): Auto-resetting (TRY)				
		27 (1027): Universal DO (U-DO)				
		28 (1028): Heat sink overheat early warning (OH)				
		30 (1030): Lifetime alarm (LIFE)				
		31 (1031): Frequency (speed) detected 2 (FDT2)				
		33 (1033): Reference loss detected (REF OFF)				
		35 (1035): Inverter output on (RUN2)				
		36 (1036): Overload prevention control (OLP)				
		37 (1037): Current detected (ID)				
		38 (1038): Current detected 2 (ID2)*10				
		42 (1042): PID alarm (PID-ALM)				
		43 (1043): Under PID control (PID-CTL)				
		44 (1044): Motor stopped due to slow flowrate under PID control (PID-STP)*				
		45 (1045): Low output torque detected (U-TL)				
		52 (1052): Running forward (FRUN)				
		53 (1053): Running reverse (RRUN)				
		54 (1054): In remote operation (RMT)				
		55 (1055): Run command entered (AX2)				
		56 (1056): Motor overheat detected by thermistor (THM)				
		59 (1059): Terminal [C1] wire break (C1OFF)				
		84 (1084): Maintenance timer (MNT)				
		87(1087): Frequency arrival signal (FARFDT)				
		95(1095): Running in fire mode (FMRUN)				
		98 (1098): Light alarm (L-ALM)				
		99 (1099): Alarm output (for any alarm) (ALM)				
		101(1101): EN terminal detection circuit error (DECF)				
		102(1102): EN terminal OFF (ENOFF)				

* Available in the ROM version 1600 or later.

*10 Available at ROM version 2450 or later.

Code	Name	Data setting range	Change when running	Data copying	Default setting	Related page
		111 (1111): Customizable logic output signal 1 (CLO1) 112 (1112): Customizable logic output signal 2 (CLO2) 113 (1113): Customizable logic output signal 3 (CLO3) 114 (1114): Customizable logic output signal 4 (CLO4) 115 (1115): Customizable logic output signal 5 (CLO5) 116 (1116): Customizable logic output signal 6 (CLO6) 117 (1117): Customizable logic output signal 7 (CLO7) 190 (1190): In timer operation (TMD) 191 (1191): Timer 1 enabled (TMD1) 192 (1192): Timer 2 enabled (TMD2) 193 (1193): Timer 3 enabled (TMD3) 194 (1194): Timer 4 enabled (TMD4) 200 (1200): Under PID2 control (PID2) 201 (1201): PID1 alarm (PV1-ALM) 202 (1202): PID1 feedback error (PV1-OFF) 203 (1203): PID2 alarm (PV2-ALM) 204 (1204): PID2 feedback error (PV2-OFF) 211 (1211): Under external PID1 control (EPID1-CTL) 212 (1212): External PID1 output (EPID1-OUT) 213 (1213): Running under external PID1 (EPID1-RUN) 214 (1214): External PID1 alarm (EPV1-ALM) 215 (1215): External PID1 feedback error (EPV1-OFF) 221 (1221): Under external PID2 control (EPID2-CTL) 222 (1222): External PID2 output (EPID2-OUT) 223 (1223): Running under external PID2 (EPID2-RUN) 224 (1224): External PID2 alarm (EPV2-ALM) 225 (1225): External PID2 feedback error (EPV2-OFF) 231 (1231): Under external PID3 control (EPID3-CTL) 232 (1232): External PID3 output (EPID3-OUT) 233 (1233): Running under external PID3 (EPID3-RUN) 234 (1234): External PID3 alarm (EPV3-ALM) 235 (1235): External PID3 feedback error (EPV3-OFF) Setting the value in parentheses () shown above assigns a negative logic output to a terminal. (True if OFF.) Setting the value of 1000s in parentheses () shown above assigns a negative logic input to a terminal.				6-106
E30	Frequency Arrival (Hysteresis width)	0.0 to 10.0 Hz	Y	Y	2.5	6-118
E31	Frequency Detection 1 (Level)	0.0 to 120.0 Hz	Y	Y	60.0	6-119
E32	(Hysteresis width)	0.0 to 120.0 Hz	Y	Y	1.0	
E34	Overload Early Warning/Current Detection (Level)	OFF: Disable 1 to 150% of inverter rated current	Y	Y1	*2	6-121
E35	(Timer)	0.01 to 600.00s	Y	Y	10.00	
E37	Current Detection 2 (Level) *10	OFF: Disable 1 to 150% of inverter rated current	Y	Y1	*2	
E38	(Timer) *10	0.01 to 600.00s	Y	Y	10.00	
E61	Terminal [12] Extended Function	0: None	N	Y	0	6-121
E62	Terminal [C1] Extended Function	1: Auxiliary frequency command 1	N	Y	0	
E63	Terminal [V2] Extended Function	2: Auxiliary frequency command 2 3: PID process command 1 4: PID process command 2 5: PID feedback value 1 12: Acceleration/deceleration time ratio setting 13: Upper limit frequency 14: Lower limit frequency 20: Analog signal input monitor 30: PID feedback value 2 31: Auxiliary input 1 to PID process command 32: Auxiliary input 2 to PID process command 33: Flowrate sensor* 41: External PID process command 1 42: External PID feedback value 1 43: External PID manual command 1 44: External PID process command 2 45: External PID feedback value 2 46: External PID manual command 2 47: External PID process command 3 48: External PID feedback value 3 49: External PID manual command 3	N	Y	0	
E64	Saving of Digital Reference Frequency	0: Automatic saving (when main power is turned OFF) 1: Saving by pressing () key	Y	Y	1	
E65	Reference Loss Detection (Continuous running frequency)	OFF: Cancel Decel: Decelerate to stop 20% to 120%	Y	Y	OFF	6-123
E80	Low Torque Detection (Level)	0% to 150%	Y	Y	20	6-124

* Available in the ROM version 1500 or later.
 *2 The motor rated current is automatically set. See Table B (function code P03).
 *10 Available at ROM version 2450 or later.

Code	Name	Data setting range	Change when running	Data copying	Default setting	Related page
		Selecting function code data assigns the corresponding function to terminals [FWD] and [REV] as listed below.				6-124
E98	Terminal [FWD] Function	0 (1000): Select multistep frequency (0 to 1 steps) (SS1)	N	Y	98	
E99	Terminal [REV] Function	1 (1001): Select multistep frequency (0 to 3 steps) (SS2)	N	Y	99	
		2 (1002): Select multistep frequency (0 to 7 steps) (SS4)				
		3 (1003): Select multistep frequency (0 to 15 steps) (SS8)				
		4 (1004): Select ACC/DEC time (2 steps) (RT1)				
		5 (1005): Select ACC/DEC time (4 steps) (RT2)				
		6 (1006): Enable 3-wire operation (HLD)				
		7 (1007): Coast to a stop (BX)				
		8 (1008): Reset alarm (RST)				
		9 (1009): Enable external alarm trip (THR) (9 = Active OFF, 1009 = Active ON)				
		11 (1011): Select frequency command 2/1 (Hz2/Hz1)				
		13: Enable DC braking (DCBRK)				
		14 (1014): Select torque limiter level 2/1 (TL2/TL1)				
		15: Switch to commercial power (50 Hz) (SW50)				
		16: Switch to commercial power (60 Hz) (SW60)				
		17 (1017): UP (Increase output frequency) (UP)				
		18 (1018): DOWN (Decrease output frequency) (DOWN)				
		19 (1019): Enable data change with keypad (WE-KP)				
		20 (1020): Cancel PID control (Hz/PID)				
		21 (1021): Switch normal/inverse operation (IVS)				
		22 (1022): Interlock (IL)				
		24 (1024): Enable communications link via RS-485 or fieldbus (LE)				
		25 (1025): Universal DI (U-DI)				
		26 (1026): Enable auto search for idling motor speed at starting (STM)				
		30 (1030): Force to stop (STOP) (30 = Active OFF, 1030 = Active ON)				
		33 (1033): Reset PID integral and differential components (PID-RST)				
		34 (1034): Hold PID integral component (PID-HLD)				
		35 (1035): Select local (keypad) operation (LOC)				
		38 (1038): Enable run commands (RE)				
		39: Protect motor from dew condensation (DWP)				
		40: Enable integrated sequence to switch to commercial power (50 Hz) (ISW50)				
		41: Enable integrated sequence to switch to commercial power (60 Hz) (ISW60)				
		58 (1058): Reset UP/DOWN frequency (STZ)				
		72 (1072): Count the run time of commercial power-driven motor 1 (CRUN-M1)				
		80 (1080): Cancel customizable logic (CLC)				
		81 (1081): Clear all customizable logic timers (CLTC)				
		87 (1087): Run command 2/1 (FR2/FR1)				
		88: Run forward 2 (FWD2)				
		89: Run reverse 2 (REV2)				
		98: Run forward (FWD)				
		99: Run reverse (REV)				
		100: No function assigned (NONE)				
		131 (1131): Flowrate switch (FS)*				
		132 (1132): Filter clogging reverse rotation command (FRC)				
		133 (1133): Switch PID channel (PID2/1)				
		134: Switch to fire mode (FMS)				
		171 (1171): PID multistep command (PID-SS1)				
		172 (1172): PID multistep command (PID-SS2)				
		181 (1181): External PID multistep command (EPID-SS1)				
		182 (1182): External PID multistep command (EPID-SS2)				
		190 (1190): Cancel timer (TMC)				
		191 (1191): Enable timer 1 (TM1)				
		192 (1192): Enable timer 2 (TM2)				
		193 (1193): Enable timer 3 (TM3)				
		194 (1194): Enable timer 4 (TM4)				
		201 (1201): External PID control 1 ON command (EPID1-ON)				
		202 (1202): Cancel external PID control 1 (%/EPID1)				
		203 (1203): Switch normal/inverse operation under external PID control 1 (EPID1-IVS)				
		204 (1204): Reset external PID1 integral and differential components (EPID1-RST)				
		205 (1205): Hold external PID1 integral component (EPID1-HLD)				

* Available in the ROM version 1500 or later.

Code	Name	Data setting range	Change when running	Data copying	Default setting	Related page
		211 (1211): External PID control 2 ON command (EPID2-ON) 212 (1212): Cancel external PID control 2 (%/EPID2) 213 (1213): Switch normal/inverse operation under external PID control 2 (EPID2-IVS) 214 (1214): Reset external PID2 integral and differential components (EPID2-RST) 215 (1215): Hold external PID2 integral component (EPID2-HLD) 221 (1221): External PID control 3 ON command (EPID3-ON) 222 (1222): Cancel external PID control 3 (%/EPID3) 223 (1223): Switch normal/inverse operation under external PID control 3 (EPID3-IVS) 224 (1224): Reset external PID3 integral and differential components (EPID3-RST) 225 (1225): Hold external PID3 integral component (EPID3-HLD) Setting the value in parentheses () shown above assigns a negative logic output to a terminal. (True if OFF.) Setting the value of 1000s in parentheses () shown above assigns a negative logic input to a terminal.				6-124

C codes: Control Functions of Frequency

Code	Name	Data setting range	Change when running	Data copying	Default setting	Related page
C01	Jump Frequency 1	0.0 to 120.0 Hz	Y	Y	0.0	6-125
C02	2		Y	Y	0.0	
C03	3		Y	Y	0.0	
C04	(Hysteresis width)		0.0 to 30.0 Hz	Y	Y	
C05	Multistep Frequency 1	0.00 to 120.00 Hz	Y	Y	0.00	
C06	2		Y	Y	0.00	
C07	3		Y	Y	0.00	
C08	4		Y	Y	0.00	
C09	5		Y	Y	0.00	
C10	6		Y	Y	0.00	
C11	7		Y	Y	0.00	
C12	8		Y	Y	0.00	
C13	9		Y	Y	0.00	
C14	10		Y	Y	0.00	
C15	11		Y	Y	0.00	
C16	12		Y	Y	0.00	
C17	13		Y	Y	0.00	
C18	14		Y	Y	0.00	
C19	15		Y	Y	0.00	
C21	Pattern Operation (Mode selection)	0: Carry out a single cycle of the specified pattern operation and stop the inverter output 1: Carry out the specified pattern operation repeatedly and stop the inverter output upon receipt of a stop command. 2: Carry out a single cycle of the specified pattern operation and continue to run at the last reference frequency.	N	Y	0	6-127
C22	Pattern Operation (Stage 1)	0.00 to 6000.00 s FWD/RED 1 to 4	Y	Y	0.00 FWD 1	6-128
C23	(Stage 2)					
C24	(Stage 3)					
C25	(Stage 4)					
C26	(Stage 5)					
C27	(Stage 6)					
C28	(Stage 7)					
C30	Frequency Command 2	0: Enable \odot / \ominus keys on the keypad 1: Voltage input to terminal [12] (-10 to +10 VDC) 2: Current input to terminal [C1] (4 to 20 mA DC) 3: Sum of voltage and current inputs to terminals [12] and [C1] 5: Voltage input to terminal [V2] (0 to 10 VDC) 7: Terminal command <i>UP/DOWN</i> control 8: Enable \odot / \ominus keys on the keypad (balanceless-bumpless switching available) 10: Pattern operation	N	Y	2	6-130
C31	Analog Input Adjustment for [12] (Offset)	-5.0% to 5.0%	Y*	Y	0.0	
C32	(Gain)	0.00% to 200.00%	Y*	Y	100.00	
C33	(Filter time constant)	0.00 to 5.00 s	Y	Y	0.05	
C34	(Gain base point)	0.00% to 100.00%	Y*	Y	100.00	
C35	(Polarity)	0: Bipolar 1: Unipolar	N	Y	1	
C36	Analog Input Adjustment for [C1] (Offset)	-5.0% to 5.0%	Y*	Y	0.0	
C37	(Gain)	0.00% to 200.00%	Y*	Y	100.00	
C38	(Filter time constant)	0.00 to 5.00s	Y	Y	0.05	
C39	(Gain base point)	0.00% to 100.00%	Y*	Y	100.00	
C40	Terminal [C1] Input Range Selection	0: 4 to 20 mA 1: 0 to 20 mA	N	Y	0	
C41	Analog Input Adjustment for [V2] (Offset)	-5.0% to 5.0%	Y*	Y	0.0	
C42	(Gain)	0.00% to 200.00%	Y*	Y	100.00	
C43	(Filter time constant)	0.00 to 5.00 s	Y	Y	0.05	
C44	(Gain base point)	0.00% to 100.00%	Y*	Y	100.00	
C45	(Polarity)	0: Bipolar 1: Unipolar	N	Y	1	
C53	Selection of Normal/Inverse Operation (Frequency command 1)	0: Normal operation 1: Inverse operation	Y	Y	0	
C55	Analog Input Adjustment for Terminal [12] (Bias value)	-100.00 to 100.00%	Y	Y	0.00	
C56	(Bias base point)	0.00 to 100.00%	Y	Y	0.00	

Code	Name	Data setting range	Change when running	Data copying	Default setting	Related page
C58	Analog Input Adjustment for Terminal [12] (Display unit)	1: none 2: % 4: r/min 7: kW <u>Flowrate</u> 20: m ³ /s 21: m ³ /min 22: m ³ /h 23: L/s 24: L/min 25: L/h <u>Pressure</u> 40: Pa 41: kPa 42: MPa 43: mbar 44: bar 45: mmHg 46: psi (Pound per square inch) 47: mWG 48: inWG <u>Temperature</u> 60: K 61: °C 62: °F <u>Density</u> 80: ppm	Y	Y	2	6-132
C59	(Maximum scale)	-999.00 to 0.00 to 9990.00	N	Y	100	6-133
C60	(Minimum scale)	-999.00 to 0.00 to 9990.00	N	Y	0.00	
C61	Analog Input Adjustment for Terminal [C1] (Bias value)	-100.00 to 100.00%	Y	Y	0.00	
C62	(Bias base point)	0.00 to 100.00%	Y	Y	0.00	
C64	(Display unit)	Same as C58.	Y	Y	2	6-134
C65	(Maximum scale)	-999.00 to 0.00 to 9990.00	N	Y	100	6-135
C66	(Minimum scale)	-999.00 to 0.00 to 9990.00	N	Y	0.00	
C67	Analog Input Adjustment for Terminal [V2] (Bias value)	-100.00 to 100.00%	Y	Y	0.00	6-136
C68	(Bias base point)	0.00 to 100.00%	Y	Y	0.00	
C70	(Display unit)	Same as C58.	Y	Y	2	
C71	(Maximum scale)	-999.00 to 0.00 to 9990.00	N	Y	100	6-130
C72	(Minimum scale)	-999.00 to 0.00 to 9990.00	N	Y	0.00	
C94	Jump Frequency 4	*10 0.0 to 120.0 Hz	Y	Y	6-125	6-130
C95	5	*10	Y	Y	0.0	
C96	6	*10	Y	Y	0.0	

P codes: Motor 1 Parameters

Code	Name	Data setting range	Change when running	Data copying	Default setting	Related page
P01	Motor 1 (No. of poles)	2 to 22 poles	N	Y1	4	6-137
P02	(Rated capacity)	0.01 to 1000.00 kW (when P99 = 0 or 4) 0.01 to 1000.00 HP (when P99 = 1)	N	Y1	*4	
P03	(Rated current)	0.00 to 2000.00 A	N	Y1	*4	
P04	(Auto-tuning)	0: Disable 1: Tune the motor while it is stopped (%R1, %X) 2: Tune the motor while it is rotating under V/f control (%R1, %X, no-load current)	N	N	0	6-138
P05	(Online-tuning)	0: Disable 1: Enable	Y	Y	0	6-139
P06	(No-load current)	0.00 to 2000.00 A	N	Y1	*4	
P07	(%R1)	0.00% to 50.00%	Y	Y1	*4	
P08	(%X)	0.00% to 50.00%	Y	Y1	*4	
P10	(Slip compensation response time)	0.01 to 10.00 s	Y	Y1	0.50	6-140
P12	(Rated slip frequency)	0.00 to 15.00 Hz	N	Y1	*4	
P99	Motor 1 Selection	0: Motor characteristics 0 (Fuji standard motors, 8-series) 1: Motor characteristics 1 (HP rating motors) 4: Other motors	N	Y1	1	

The shaded function codes () are applicable to the quick setup.

*4 The motor parameters are set by capacities. See Table B.

*10 Available at ROM version 2450 or later.

H codes: High Performance Functions

Code	Name	Data setting range	Change when running	Data copying	Default setting	Related page	
H03	Data Initialization	0: Disable initialization 1: Initialize all function code data to factory defaults 2: Initialize motor 1 parameters 10: Initialize real-time clock information 11: Initialize function code data except communication function codes 12: Initialize U code data (Customizable logic function codes) 71: Initialize according to application (Compressor) 72: Initialize according to application (Fan) 73: Initialize according to application (Single pump)	N	N	0	6-141	
H04	Auto-reset (Times)	OFF: Disable; 1 to 20	Y	Y	OFF	6-146	
H05	(Reset interval)	0.5 to 60.0 s	Y	Y	5.0		
H06	Cooling Fan ON/OFF Control	0: Disable (Always in operation) 1: Enable (ON/OFF controllable)	Y	Y	1	6-148	
H07	Acceleration/Deceleration Pattern	0: Linear 1: S-curve (Weak) 2: S-curve (Strong) 3: Curvilinear	Y	Y	0		
H08	Rotational Direction Limitation	0: Disable 1: Enable (Reverse rotation inhibited) 2: Enable (Forward rotation inhibited) 3: Enable (Reverse rotation inhibited, setting only) 4: Enable (Forward rotation inhibited, setting only)	N	Y	0		
H09	Starting Mode (Auto search)	0: Disable 1: Enable (At restart after momentary power failure) 2: Enable (At restart after momentary power failure and at normal start)	N	Y	0	6-151	
H11	Deceleration Mode	0: Normal deceleration 1: Coast-to-stop	Y	Y	0		
H12	Instantaneous Overcurrent Limiting (Mode selection)	0: Disable 1: Enable	Y	Y	1		
H13	Restart Mode after Momentary Power Failure (Restart time)	0.1 to 20.0 s	Y	Y1	*1		
H14	(Frequency fall rate)	Inherit: With the selected deceleration time 0.01 to 100.00 Hz/s Auto: With the current limiter	Y	Y	Auto		
H15	(Continuous running level)	200 to 300 Vdc (230 V class series) 400 to 600 Vdc (460 V class series) 575 to 863 Vdc (575 V class series)	Y	Y1	235 470 674		
H16	(Allowable momentary power failure time)	Auto: Automatically determined by inverter 0.0 to 30.0 s	Y	Y	Auto		
H26	Thermistor (for motor) (Mode selection)	0: Disable 1: PTC (The inverter immediately trips with OH4 displayed.) 2: PTC (The inverter issues output signal THM and continues to run.)	Y	Y	0	6-153	
H27	(Level)	0.00 to 5.00 V	Y	Y	0.35		
H30	Communications Link Function (Mode selection)	Frequency command Run command 0: F01/C30 F02 1: RS-485 (Port 1) F02 2: F01/C30 RS-485 (Port 1) 3: RS-485 (Port 1) RS-485 (Port 1) 4: RS-485 (Port 2) F02 5: RS-485 (Port 2) RS-485 (Port 1) 6: F01/C30 RS-485 (Port 2) 7: RS-485 (Port 1) RS-485 (Port 2) 8: RS-485 (Port 2) RS-485 (Port 2)	Y	Y	0	6-155	
H42	Capacitance of DC Link Bus Capacitor	Meas (Measure initial value), Failed (Measurement failed), 2 to 65535 Indication for replacement of DC link bus capacitor	Y	N	-		
H43	Cumulative Run Time of Cooling Fan	Indication for replacement of cooling fan 0 to 99990 (in units of 10 hours)	Y	N	-		
H44	Startup Counter for Motor 1	Indication of cumulative startup count 0 to 65535	Y	N	-		6-158
H45	Mock Alarm	0: Disable 1: Enable (Once a mock alarm occurs, the data automatically returns to 0.)	Y	N	0		6-159
H46	Starting Mode (Auto search delay time 2)	0.1 to 20.0 s	Y	Y1	*4		
H47	Initial Capacitance of DC Link Bus Capacitor	Meas (Measure initial value), Failed (Measurement failed), 2 to 65535 Indication for replacement of DC link bus capacitor	Y	N	-		
H48	Cumulative Run Time of Capacitors on Printed Circuit Boards	Indication for replacement of capacitors 0 to 99990 (in units of 10 hours)	Y	N	-	6-159	
H49	Starting Mode (Auto search delay time 1)	0.0 to 10.0 s	Y	Y	0.0		

*1 The factory default differs depending upon the inverter's capacity. See Table A.

*4 The motor parameters are set by capacities. See Table B.

Code	Name	Data setting range	Change when running	Data copying	Default setting	Related page
H50	Non-linear V/f Pattern 1 (Frequency)	OFF: Cancel, 0.1 to 120.0 Hz	N	Y	OFF	6-159
H51	(Voltage)	0-240 V: Output an AVR-controlled voltage (230 V class series) 0-500 V: Output an AVR-controlled voltage (460 V class series) 0-690 V: Output an AVR-controlled voltage (575 V class series)	N	Y1	0	
H52	Non-linear V/f Pattern 2 (Frequency)	OFF: Cancel, 0.1 to 120.0 Hz	N	Y	OFF	
H53	(Voltage)	0-240 V: Output an AVR-controlled voltage (230 V class series) 0-500 V: Output an AVR-controlled voltage (460 V class series) 0-690 V: Output an AVR-controlled voltage (575 V class series)	N	Y1	0	
H56	Deceleration Time for Forced Stop	0.00 to 3600 s	Y	Y	20.0	
H61	Multistep Frequency + UP/DOWN Control (Initial frequency setting)	1: Last UP/DOWN command value on releasing the run command 13 to 106: Multistep frequency + UP/DOWN command (Initial value to be preserved)	N	Y	1	6-160
H63	Low Limiter (Mode selection)	0: Limit by F16 (Frequency limiter: Low) and continue to run 1: If the output frequency lowers below the one limited by F16 (Frequency limiter: Low), decelerate to stop the motor.	Y	Y	0	6-164
H64	(Lower limiting frequency)	Inherit: Depends on F16 (Frequency limiter, Low) 0.1 to 60.0 Hz	Y	Y	2.0	
H68	Slip Compensation 1 (Operating conditions)	0: Enable during ACC/DEC and at base frequency or above 1: Disable during ACC/DEC and enable at base frequency or above 2: Enable during ACC/DEC and disable at base frequency or above 3: Disable during ACC/DEC and at base frequency or above	N	Y	0	
H69	Automatic Deceleration (Mode selection)	0: Disable 2: Torque limit control with Force-to-stop if actual deceleration time exceeds three times the specified one 3: DC link bus voltage control with Force-to-stop if actual deceleration time exceeds three times the specified one 4: Torque limit control with Force-to-stop disabled 5: DC link bus voltage control with Force-to-stop disabled	Y	Y	0	
H70	Overload Prevention Control	OFF: Cancel Inherit: Follow the selected deceleration time 0.01 to 100.00 Hz/s	Y	Y	OFF	6-165
H71	Deceleration Characteristics	0: Disable 1: Enable	Y	Y	0	6-166
H72	Main Power Down Detection (Mode selection)	0: Disable 1: Enable	Y	Y	1	
H76	Torque Limiter for Braking (Frequency increment limit)	0.0 to 120.0 Hz	Y	Y	5.0	
H77	Service Life of DC Link Bus Capacitor (Remaining time)	0 to 43800 (in units of 10 hours)	Y	N	NEMA/UL Type 1/12: 43800 UL open type : 87600	6-167
H78	Maintenance Interval (M1)	OFF: Disable 10 to 99990 (in units of 10 hours)	Y	N		
H79	Preset Startup Count for Maintenance (M1)	OFF: Disable 1 to 65535	Y	N	OFF	6-168
H80	Output Current Fluctuation Damping Gain for Motor 1	0.00 to 1.00	Y	Y	0.20	
H89	Reserved *5	0, 1	Y	Y	1	6-169
H90	Reserved *5	0, 1	Y	Y	0	
H91	Current Input Wire Break Detection	OFF: Disable, 0.1 to 60.0 s	Y	Y	OFF	
H92	Continuity of Running (P)	Auto: Adjust automatically 0.000 to 10.000 times	Y	Y1	Auto	
H93	(I)	Auto: Adjust automatically 0.010 to 10.000 s	Y	Y1	Auto	
H94	Cumulative Motor Run Time 1	0 to 99990 (The cumulative run time can be modified or reset in units of 10 hours.)	N	N	-	
H95	DC Braking (Braking response mode)	0: Slow 1: Quick	Y	Y	1	
H96	STOP Key Priority/Start Check Function	Data STOP key priority Start check function 0: Disable Disable 1: Enable Disable 2: Disable Enable 3: Enable Enable	Y	Y	3	6-170
H97	Clear Alarm Data	0: Disable 1: Enable (Setting "1" clears alarm data and then returns to "0.")	Y	N	0	
H98	Protection/Maintenance Function (Mode selection)	0 to 255 Bit 0: Lower the carrier frequency automatically (0: Disabled; 1: Enabled) Bit 1: Detect input phase loss (0: Disabled; 1: Enabled) Bit 2: Detect output phase loss (0: Disabled; 1: Enabled) Bit 3: Select life judgment threshold of DC link bus capacitor (0: Factory default level; 1: User setup level) Bit 4: Judge the life of DC link bus capacitor (0: Disabled; 1: Enabled) Bit 5: DC fan lock detection (0: Disabled; 1: Enabled) Bit 7: Switch NEMA/UL Type 1, NEMA/UL Type 12 enclosure (0: NEMA/UL Type 1; 1: NEMA/UL Type 12)	Y	Y	UL open type , NEMA/UL Type 1 : 19 NEMA/UL Type 12 : 147	6-171

*5 These function codes are reserved for particular manufacturers. Unless otherwise specified, do not access these function codes.

Code	Name	Data setting range	Change when running	Data copying	Default setting	Related page
H104	Number-of-retry Clear Time	0.5 to 5.0 (min)	Y	Y	5.0	6-190
H105	Retry Target Selection	0 to 255 Bit 0: OC1 to OC3 Bit 1: OV1 to OV3 Bit 2: OH1 OH3 OLU Bit 3: - Bit 4: OL1 Bit 5: OH4 Bit 6: - Bit 7: -	Y	Y	225	
H106	Retry Target Selection 2	0 to 255 Bit 0: OH2 Bit 1: LV Bit 2: - Bit 3: - Bit 4: - Bit 5: - Bit 6: - Bit 7: -	Y	Y	0	6-191
H110	Input Phase Loss Protection Avoidance Operation (Mode selection)	0: Disable 1: Enable (Decrease output frequency)	Y	Y	0	6-194
H112	Voltage Shortage Avoidance Operation (Mode selection)	0: Disable 1: Enable (Decrease output frequency)	Y	Y	0	
H114	Automatic Deceleration (Operation level)	Auto: Adjust automatically 0.0 to 50.0%	Y	Y	Auto	
H116	Fire Mode (Mode selection)	0: FMS: ON 1: FMS toggle method 2: FMS latch method	N	Y	0	6-176
H117	(Confirmation time)	0.5 to 10.0 s * Set ON/OFF setting time for FMS signals.	Y	Y	3.0	
H118	(Reference frequency)	Inherit: Follow the ordinary reference frequency specified with F01, etc. 0.1 to 120.0 Hz	Y	Y	Inherit	
H119	(Rotation direction)	0: Follow the run command specified with F02, etc. 2: Forward rotation 3: Reverse rotation	N	Y	0	
H120	(Start method)	0: Follows the start methods specified with instant power failure restart 1: Auto search	Y	Y	0	
H121	(Reset interval)	0.5 to 20.0 s	Y	Y	5.0	
H181	Light Alarm Selection 1	0 to 255 Bit 0: - Bit 1: OH2 Bit 2: OH3 Bit 3: - Bit 4: - Bit 5: OL1 Bit 6: - Bit 7: -	Y	Y	0	6-178
H182	Light Alarm Selection 2	0 to 255 Bit 0: - Bit 1: - Bit 2: Er4 Bit 3: Er5 Bit 4: Er8 Bit 5: ErP Bit 6: - Bit 7: -	Y	Y	0	
H183	Light Alarm Selection 3	0 to 255 Bit 0: - Bit 1: - Bit 2: - Bit 3: CoF, PV1, PV2, PVA, PVb, PVC Bit 4: FAL Bit 5: OL Bit 6: OH Bit 7: LiF	Y	Y	0	

Code	Name	Data setting range	Change when running	Data copying	Default setting	Related page
H184	Light Alarm Selection 4	0 to 255 Bit 0: rEF Bit 1: PA1, PA2, PAA, PAB, PAC Bit 2: UTL Bit 3: PTC Bit 4: rTE Bit 5: CnT Bit 6: - Bit 7: Lob, dtL	Y	Y	128	6-178
H197	User Password 1 (Mode selection)	0: Disclose all function codes but prohibit any change 1: Disclose function codes selected for quick setup only and allow change * This specifies the protection of user password 1.	Y	Y	0	6-180

J codes: Application Functions 1

Code	Name	Data setting range	Change when running	Data copying	Default setting	Related page
J21	Dew Condensation Prevention (Duty)	1% to 50%	Y	Y	1	6-181
J22	Commercial Power Switching Sequence	0: Keep inverter operation (Stop due to alarm) 1: Automatically switch to commercial-power operation	N	Y	0	

J1 codes: PID Control 1

Code	Name	Data setting range	Change when running	Data copying	Default setting	Related page
J101	PID Control 1 (Mode selection)	0: Disable 1: Enable (Process control, normal operation) 2: Enable (Process control, inverse operation)	N	Y	0	6-182
J102	(Command selection)	0: Keypad (↶/↷ key) 1: PID command 1 (Analog input: Terminals [12], [C1] and [V2]) 3: UP/DOWN 4: Command via communications link (Use function code S13)	N	Y	0	6-184
J103	(Feedback selection)	1: PID control 1 feedback value 10: Addition (PID control 1 feedback value + PID control 2 feedback value) 11: Difference (PID control 1 feedback value - PID control 2 feedback value) 12: Average (PID control 1 feedback value, PID control 2 feedback value) 13: Maximum (PID control 1 feedback value, PID control 2 feedback value) 14: Minimum (PID control 1 feedback value, PID control 2 feedback value)	N	Y	1	6-189
J104	(Deviation selection)	0: (J102)-(J103) 1: Selection of maximum (selection of maximum for PID control 1 and 2 deviation) 2: Selection of minimum (selection of minimum for PID control 1 and 2 deviation)	N	Y	0	6-190

Code	Name	Data setting range	Change when running	Data copying	Default setting	Related page
J105	PID Control 1 (Display unit)	0: Based on the unit/scale of the PID control 1 feedback amount 1: none 2: % 4: r/min 7: kW <u>Flowrate</u> 20: m ³ /s 21: m ³ /min 22: m ³ /h 23: L/s 24: L/min 25: L/h <u>Pressure</u> 40: Pa 41: kPa 42: MPa 43: mbar 44: bar 45: mmHg 46: psi (Pound per square inch) 47: mWG 48: inWG <u>Temperature</u> 60: K 61: °C 62: °F <u>Density</u> 80: ppm	N	Y	0	6-190
J106	(Maximum scale)	-999.00 to 0.00 to 9990.00	N	Y	100	6-191
J107	(Minimum scale)	-999.00 to 0.00 to 9990.00	N	Y	0.00	
J108	(Tuning)	0: Disable 1: Short-time response 2: Long-time response	Y	Y	0	6-192
J109	(Tuning manipulated value)	10 to 100% (Maximum frequency = 100%)	Y	Y	10%	
J110	P (Gain)	0.000 to 30.000 times	Y	Y	0.100	6-194
J111	I (Integral time)	0.0 to 3600.0 s	Y	Y	0.0	
J112	D (Differential time)	0.00 to 600.00 s	Y	Y	0.00	
J113	(Feedback filter)	0.0 to 900.0 s	Y	Y	0.5	
J114	(Anti-reset wind-up)	OFF: Disable 0.01 to 9990.00 *6	Y	Y	OFF	
J118	(Upper limit of PID process output)	Inherit: Depends on setting of F15 0.0 to 120.0 Hz	Y	Y	Inherit	6-198
J119	(Lower limit of PID process output)	Inherit: Depends on setting of F16 0.0 to 120.0 Hz	Y	Y	Inherit	
J121	(Alarm output selection)	0: Absolute-value alarm 1: Absolute-value alarm (with Hold) 2: Absolute-value alarm (with Latch) 3: Absolute-value alarm (with Hold and Latch) 4: Deviation alarm 5: Deviation alarm (with Hold) 6: Deviation alarm (with Latch) 7: Deviation alarm (with Hold and Latch)	Y	Y	0	
J122	(Upper level alarm (AH))	OFF: Disable -999.00 to 0.00 to 9990.00 *6	Y	Y	OFF	
J124	(Lower level alarm (AL))	OFF: Disable -999.00 to 0.00 to 9990.00 *6	Y	Y	OFF	
J127	(Feedback failure detection (Mode selection))	0: Disable (Turns ON output signals (PV1-OFF) and continues operation.) 1: Enable (Free run stop (PV1 trip)) 2: Enable (Deceleration and stop (PV1 trip)) 3: Enable (Continuation of operation at the maximum frequency (upper limit frequency)) 4: Enable (Continuation of operation at the minimum frequency (lower limit frequency)) 5: Enable (Continuation of operation at the frequency used when failure is detected.) 6: Enable (Shift to PID control 2 (PID control 1 is restored when failure is recovered from.))	Y	Y	0	6-201

*6 The upper and lower level values are restricted by the maximum and minimum scales.

Code	Name	Data setting range	Change when running	Data copying	Default setting	Related page
J128	(Feedback failure continuation duration)	Cont.: After detection of the failure, continue to run as specified by J127. After stop (output shutoff), cause a PV1 trip. 0 to 3600 s	Y	Y	Cont.	6-201
J129	(Feedback failure upper-limit)	Auto: 105% equivalent -999.00 to 0.00 to 9990.00 *6	Y	Y	Auto	6-201
J130	(Feedback failure lower-limit)	Auto: -5% equivalent -999.00 to 0.00 to 9990.00 *6	Y	Y	Auto	
J131	(Feedback failure detection time)	0.0 to 300.0 s	Y	Y	0.1	
J136	PID Multistep Command (Multistep command 1)	-999.00 to 0.00 to 9990.00	Y	Y	0.00	
J137	(Multistep command 2)		Y	Y	0.00	
J138	(Multistep command 3)		Y	Y	0.00	
J149	Slow Flowrate Stop Function (Mode selection)	OFF: Disable 1: Manual operation (stop judgment: MV) 2: Manual operation (stop judgment: PV) 11: Auto operation 1 (stop judgment: MV): Deviation detection method 12: Auto operation 1 (stop judgment: PV): Deviation detection method 21: Auto operation 2 (stop judgment: MV): Flowrate sensor detection method 22: Auto operation 2 (stop judgment: PV): Flowrate sensor detection method	N	Y	OFF	6-209
J150	(Operation level)	Auto: Adjust automatically 0.00 to 120.00 Hz when J149 = MV 0.00 to 9990.00 when J149 = PV *6	Y	Y	Auto	
J151	(Elapsed time)	0 to 60 s	Y	Y	0	
J152	(Auto-operation frequency lower-limit)	0.0 to 120.0 Hz	Y		0.0	
J153	(Pressurization starting frequency)	0.0 to 120.0 Hz	Y	Y	0.0	
J154	(Pressurizing time)	0 to 60 s	Y	Y	0	
J156	(Initiation inhibition time)	0 to 3600 s	Y	Y	0	
J157	(Cancel frequency)	OFF: Disable 0.0 to 120.0 Hz	Y		0.0	
J158	(Cancel deviation level 1)	OFF: Disable 0.01 to 9990.00 *6	Y	Y	OFF	
J159	(Cancel delay timer)	0 to 3600s	Y	Y	0	
J160	(Cancel deviation level 2)	OFF: Disable 0.01 to 9990.00 *6	Y	Y	OFF	
J163	Flowrate Sensor (Input selection)	0: Inherit Follow analog input selected by E61, E62, and E63. 1: PV1 20: m ³ /s 21: m ³ /min 22: m ³ /h 23: L/s 24: L/min 25: L/h Note: Data 20 or above is to be used for connection of customizable logic.	N	Y	0	
J164	(ON level)	OFF: Disable 0.00 to 9990.00 *6 Note: If J163 = 20 or above, no scale can be defined, so the setting range should be from the minimum to maximum.	Y	Y	OFF	
J165	(OFF level)	OFF: Disable 0.00 to 9990.00 *6 Note: If J163 = 20 or above, no scale can be defined, so the setting range should be from the minimum to maximum.	Y	Y	OFF	
J166	(Input filter)	0.00 to 5.00s	Y	Y	0.20	
J188	Filter Clogging Prevention/ Anti Jam Function (Input selection)	0: Disable 1: Enable (Anti jam protection, inverter stop with rLo trip) 2: Enable (Filter clogging trouble, inverter stop with FoL trip) 3: Enable (While warning (filter clogging trouble) is output, operation is continued.)	Y	Y	0	6-210

* J149-J166 are available in the ROM version 1600 or later.

*6 The upper and lower level values are restricted by the maximum and minimum scales.

Code	Name	Data setting range	Change when running	Data copying	Default setting	Related page
J189	Filter Clogging Prevention Function (Reverse operation cycle time)	OFF: Disable 1 to 10000 h	Y	Y	OFF	6-210
J190	(Load resistance current)	OFF: Disable 1% to 150% of the inverter rated current	Y	Y	OFF	
J191	(Load resistance PV signal)	-999.00 to 0.00 to 9990.00 *6 OFF	Y	Y	OFF	
J192	(Load resistance detection timer)	0 to 600 s	Y	Y	0	
J193	Filter Clogging Prevention/ Anti Jam Function (Reverse rotation running frequency)	0.0 to 120.0 Hz	Y	Y	6.0	
J194	(Reverse rotation running time)	0 to 600 s	Y	Y	0	
J195	(Number of allowable reverse runs)	1 to 10 times	Y	Y	3	
J198	Wet-bulb temperature presumption control	OFF: Disable 0.01 to 120.00 Hz/min	Y	Y	OFF	6-214

J2 codes: PID Control 2

Code	Name	Data setting range	Change when running	Data copying	Default setting	Related page
J201	PID Control 2 (Mode selection)	0: Disable 1: Enable (Process control, normal operation) 2: Enable (Process control, inverse operation)	N	Y	0	6-215
J202	(Command selection)	0: Keypad (↶↷) key 1: PID command 1 (Analog input: Terminals [12], [C1] and [V2]) 2: PID command 2 (Analog input: Terminals [12], [C1] and [V2]) 3: UP/DOWN 4: Command via communications link (Use function code S13) 101: Command under PID control 1 (J102)	N	Y	0	
J203	(Feedback selection)	1: PID control 1 feedback value 2: PID control 2 feedback value 13: Maximum (PID control 1 feedback value, PID control 2 feedback value)	N	Y	2	
J205	(Display unit)	0: Based on the unit/scale of the PID control 2 feedback amount. 1: none 2: % 4: r/min 7: kW <u>Flowrate</u> 20: m ³ /s 21: m ³ /min 22: m ³ /h 23: L/s 24: L/min 25: L/h <u>Pressure</u> 40: Pa 41: kPa 42: MPa 43: mbar 44: bar 45: mmHg 46: psi (Pound per square inch) 47: mWG 48: inWG <u>Temperature</u> 60: K 61: °C 62: °F <u>Density</u> 80: ppm	N	Y	0	
J206	(Maximum scale)	-999.00 to 0.00 to 9990.00	N	Y	100	
J207	(Minimum scale)	-999.00 to 0.00 to 9990.00	N	Y	0.00	
J208	(Tuning)	0: Disable 1: For short-time response 2: For long-time response	Y	Y	0	

*6 The upper and lower level values are restricted by the maximum and minimum scales.

Code	Name	Data setting range	Change when running	Data copying	Default setting	Related page
J209	(Tuning manipulated value)	10 to 100% (Maximum frequency = 100%)	Y	Y	10%	6-215
J210	P (Gain)	0.000 to 30.000 times	Y	Y	0.100	
J211	I (Integral time)	0.0 to 3600.0 s	Y	Y	0.0	
J212	D (Differential time)	0.00 to 600.00 s	Y	Y	0.00	
J213	(Feedback filter)	0.0 to 900.0 s	Y	Y	0.5	
J214	(Anti-reset wind-up)	OFF: Disable 0.01 to 9990.00 *6	Y	Y	OFF	
J218	(Upper limit of PID process output)	Inherit: Depends on setting of F15 0.0 to 120.0 Hz	Y	Y	Inherit	6-216
J219	(Lower limit of PID process output)	Inherit: Depends on setting of F16 0.0 to 120.0 Hz	Y	Y	Inherit	
J221	PID Control 2 (Alarm output selection)	0: Absolute-value alarm 1: Absolute-value alarm (with Hold) 2: Absolute-value alarm (with Latch) 3: Absolute-value alarm (with Hold and Latch) 4: Deviation alarm 5: Deviation alarm (with Hold) 6: Deviation alarm (with Latch) 7: Deviation alarm (with Hold and Latch) 50: Absolute value alarm (Cancel PID control)	Y	Y	0	
J222	(Upper level alarm (AH))	OFF: Disable -999 to 0.00 to 9990.00 *6	Y	Y	OFF	
J223	(Upper level alarm detection hysteresis width)	0.00 to 9990.00 *6	Y	Y	0.00	
J224	(Lower level alarm (AL))	OFF: Disable -999 to 0.00 to 9990.00 *6	Y	Y	OFF	
J225	(Upper level alarm detection hysteresis width)	0.00 to 9990.00 *6	Y	Y	0.00	
J227	(Feedback failure detection (Mode selection))	0: Disable (Turns ON output signals (PV2-ERR) and continues operation.) 1: Enable (Free run stop (PV2 trip)) 2: Enable (Deceleration and stop (PV2 trip)) 3: Enable (Continuation of operation at the maximum frequency (upper limit frequency)) 4: Enable (Continuation of operation at the minimum frequency (lower limit frequency)) 5: Enable (Continuation of operation at the frequency used when failure is detected.)	Y	Y	0	
J228	(Feedback failure continuation duration)	Cont.: After detection of the failure, continue to run as specified by J227. After stop (output shutoff), cause a PV2 trip. 0 to 3600 s	Y	Y	Cont.	
J229	(Feedback failure upper-limit)	Auto: 105% equivalent -999.00 to 0.00 to 9990.00 *6	Y	Y	Auto	
J230	(Feedback failure lower-limit)	Auto: -5% equivalent -999.00 to 0.00 to 9990.00 *6	Y	Y	Auto	
J231	(Feedback failure detection time)	0.0 to 300.0 s	Y	Y	0.1	
J249	Slow Flowrate Stop Function (Mode selection)	OFF: Disable 1: Manual operation (stop judgment: MV) 2: Manual operation (stop judgment: PV)	N	Y	OFF	
J250	(Operation level)	Auto: Adjust automatically 0.00 to 120.00 Hz when J149 = MV 0.00 to 9990.00 when J149 = PV *6	Y	Y	Auto	
J251	(Elapsed time)	0 to 60 s	Y	Y	0	
J256	(Initiation inhibition time)	0 to 3600 s	Y	Y	0	
J257	(Cancel frequency)	OFF: Disable 0.0 to 120.0 Hz	Y	Y	0.0	
J258	(Cancel deviation level 1)	OFF: Disable 0.01 to 9990.00 *6	Y	Y	OFF	
J259	(Cancel delay timer)	0 to 3600 s	Y	Y	0	
J260	(Cancel deviation level 2)	OFF: Disable 0.01 to 9990.00 *6	Y	Y	OFF	

* J249-J260 are available in the ROM version 1600 or later.

*6 The upper and lower level values are restricted by the maximum and minimum scales.

J5 codes: External PID Function 1

Code	Name	Data setting range	Change when running	Data copying	Default setting	Related page
J501	External PID Control 1 (Mode selection)	0: Disable 1: Enable process control (Normal operation) 2: Enable process control (Inverse operation) 11: Enable process control, interlocking with inverter running (Normal operation) 12: Enable process control, interlocking with inverter running (Inverse operation) 21: Enable process control by external digital signal (Normal operation) 22: Enable process control by external digital signal (Inverse operation) 31: Enable process control by external digital signal, interlocking with inverter running (Normal operation) 32: Enable process control by external digital signal, interlocking with inverter running (Inverse operation)	N	Y	0	6-217
J502	(Remote command selection)	0: Keypad (⏏/⏏) key 3: UP/DOWN 4: Command via communications link (Use function code S13) 51: External PID command 1 (Analog input: Terminals [12], [C1] and [V2])	N	Y	0	6-219
J503	(Feedback selection)	51: External PID feedback value 1 60: Addition (External PID feedback value 1 + External PID feedback value 2) 61: Difference External PID feedback value 1 - External PID feedback value 2 62: Average (External PID feedback value 1, External PID feedback value 2) 63: Maximum (External PID feedback value 1, External PID feedback value 2) 64: Minimum (External PID feedback value 1, External PID feedback value 2)	N	Y	51	6-225
J504	(Deviation selection)	0: (J502) - (J503) 51: Maximum (Maximum deviation between external PID control 1 and 2) 52: Minimum (Minimum deviation between external PID control 1 and 2)	N	Y	0	6-226
J505	(Display unit)	0: Based on the unit/scale of the PID control 1 feedback amount 1: none 2: % 4: r/min 7: kW <u>Flowrate</u> 20: m ³ /s 21: m ³ /min 22: m ³ /h 23: L/s 24: L/min 25: L/h <u>Pressure</u> 40: Pa 41: kPa 42: MPa 43: mbar 44: bar 45: mmHg 46: psi (Pound per square inch) 47: mWG 48: inWG <u>Temperature</u> 60: K 61: °C 62: °F <u>Density</u> 80: ppm	N	Y	0	6-227
J506	(Maximum scale)	-999.00 to 0.00 to 9990.00	N	Y	100.00	6-228
J507	(Minimum scale)	-999.00 to 0.00 to 9990.00	N	Y	0.00	

Code	Name	Data setting range	Change when running	Data copying	Default setting	Related page
J510	External PID Control 1 P (Gain)	ON/OFF: ON/OFF control 0.000 to 30.000 times	Y	Y	0.100	6-229
J511	I (Integral time)	0.0 to 3600.0 s	Y	Y	0.0	
J512	D (Differential time)	0.00 to 600.00 s	Y	Y	0.00	
J513	(Feedback filter)	0.0 to 900.0 s	Y	Y	0.5	
J514	(Anti-reset wind-up)	OFF: Disable 0.00 to 9990.00 *6	Y	Y	OFF	6-233
J515	(ON/OFF control hysteresis width)	0.00 to 9990.00 *6	Y	Y	0.00	6-234
J516	(Proportional operation output convergent value)	0 to 150%	Y	Y	0	6-235
J517	(Proportional cycle)	1 to 150 s	Y	Y	30	6-236
J518	(Upper limit of PID process output)	-10 to +110%	Y	Y	100	6-237
J519	(Lower limit of PID process output)	-10 to +110%	Y	Y	0	
J520	(Upper and lower limits)	0: Limit PID output with J518, J519 1: 110%, -10% of PID output with J518 exceeded or less than J519	Y	Y	0	
J521	(Alarm output selection)	0: Absolute-value alarm (PV) 1: Absolute-value alarm (PV) (with Hold) 2: Absolute-value alarm (PV) (with Latch) 3: Absolute-value alarm (PV) (with Hold and Latch) 4: Deviation alarm (PV) 5: Deviation alarm (PV) (with Hold) 6: Deviation alarm (PV) (with Latch) 7: Deviation alarm (PV) (with Hold and Latch) 8: Absolute-value alarm (SV) 9: Absolute-value alarm (SV) (with Hold) 10: Absolute-value alarm (SV) (with Latch) 11: Absolute-value alarm (SV) (with Hold and Latch) 12: Absolute-value alarm (MV) 13: Absolute-value alarm (MV) (with Hold) 14: Absolute-value alarm (MV) (with Latch) 15: Absolute-value alarm (MV) (with Hold and Latch)	Y	Y	0	6-238
J522	(Upper level alarm (AH))	OFF: Disable -999.00 to 0.00 to 9990.00 *6	Y	Y	OFF	
J524	(Lower level alarm (AL))	OFF: Disable -999.00 to 0.00 to 9990.00 *6	Y	Y	OFF	
J527	(Feedback error detection mode)	0: Disable (Turns ON output signals (EPV1-ERR) and continues operation.) 1: Enable (Free run stop (PVA trip)) 2: Enable (Deceleration and stop (PVA trip))	Y	Y	0	6-241
J529	(Feedback error upper-limit)	Auto: 105% equivalent -999.00 to 0.00 to 9990.00 *6	Y	Y	Auto	
J530	(Feedback error lower-limit)	Auto: -5% equivalent -999.00 to 0.00 to 9990.00 *6	Y	Y	Auto	
J531	(Feedback error detection time)	0.0 to 300.0 s	Y	Y	0.1	
J540	(Manual command)	0: Keypad (↖↗ key) 8: Keypad (↖↗ key) (Balanceless-bumpless) 51: External PID command 1 (Analog input: Terminals [12], [C1] and [V2])	N	Y	0	6-243
J550	External PID Multistep Command (Mode selection)	Bit 0: Enable multistep command under external PID control 1 Bit 1: Enable multistep command under external PID control 2 Bit 2: Enable multistep command under external PID control 3	N	Y	0	6-244
J551	(Multistep command 1)	-999.00 to 0.00 to 9990.00	Y	Y	0.00	
J552	(Multistep command 2)	-999.00 to 0.00 to 9990.00	Y	Y	0.00	
J553	(Multistep command 3)	-999.00 to 0.00 to 9990.00	Y	Y	0.00	

*6 The upper and lower level values are restricted by the maximum and minimum scales.

J6 codes: External PID Function 2/3

Code	Name	Data setting range	Change when running	Data copying	Default setting	Related page
J601	External PID Control 2 (Mode selection)	0: Disable 1: Enable process control (Normal operation) 2: Enable process control (Inverse operation) 11: Enable process control, interlocking with inverter running (Normal operation) 12: Enable process control, interlocking with inverter running (Inverse operation) 21: Enable process control by external digital signal (Normal operation) 22: Enable process control by external digital signal (Inverse operation) 31: Enable process control by external digital signal, interlocking with inverter running (Normal operation) 32: Enable process control by external digital signal, interlocking with inverter running (Inverse operation)	N	Y	0	6-245
J602	(Remote command selection)	0: Keypad (⏏/⏏) key 3: UP/DOWN 4: Command via communications link 51: External PID command 1 (Analog input terminals [12], [C1] and [V2]) 52: External PID command 2 (Analog input terminals [12], [C1] and [V2]) 111: Apply external PID control 1 commands	N	Y	0	
J603	(Feedback selection)	51: External PID feedback value 1 52: External PID feedback value 2	N	Y	52	
J605	(Display unit)	0: Based on the unit/scale of the PID control 1 feedback amount 1: none 2: % 4: r/min 7: kW <u>Flowrate</u> 20: m ³ /s 21: m ³ /min 22: m ³ /h 23: L/s 24: L/min 25: L/h <u>Pressure</u> 40: Pa 41: kPa 42: MPa 43: mbar 44: bar 45: mmHg 46: psi (Pound per square inch) 47: mWG 48: inWG <u>Temperature</u> 60: K 61: °C 62: °F <u>Density</u> 80: ppm	N	Y	0	

Code	Name	Data setting range	Change when running	Data copying	Default setting	Related page	
J606	External PID Control 2 (Maximum scale)	-999.00 to 0.00 to 9990.00	N	Y	100.00	6-245	
J607	(Minimum scale)	-999.00 to 0.00 to 9990.00	N	Y	0.00		
J610	P (Gain)	ON/OFF: ON/OFF control 0.000 to 30.000 times	Y	Y	0.100		
J611	I (Integral time)	0.0 to 3600.0 s	Y	Y	0.0		
J612	D (Differential time)	0.00 to 600.00 s	Y	Y	0.00		
J613	(Feedback filter)	0.0 to 900.0 s	Y	Y	0.5		
J614	(Anti-reset wind-up)	OFF: Disable 0.01 to 9990.00 *6	Y	Y	OFF		
J615	(ON/OFF control hysteresis width)	0.00 to 9990.00 *6	Y	Y	0.00		
J616	(Proportional operation output convergent value)	0 to 150%	Y	Y	0		6-246
J617	(Proportion cycle)	1 to 150 s	Y	Y	30		
J618	(Upper limit of PID process output)	-10 to 110%	Y	Y	100		
J619	(Lower limit of PID process output)	-10 to 110%	Y	Y	0		
J620	(Upper and lower limits)	0: Limit PID output with J618, J619 1: 110%, -10% of PID output with J618 exceeded or less than J619	Y	Y	0		
J621	(Alarm output selection)	0: Absolute-value alarm (PV) 1: Absolute-value alarm (PV) (with Hold) 2: Absolute-value alarm (PV) (with Latch) 3: Absolute-value alarm (PV) (with Hold and Latch) 4: Deviation alarm (PV) 5: Deviation alarm (PV) (with Hold) 6: Deviation alarm (PV) (with Latch) 7: Deviation alarm (PV) (with Hold and Latch) 8: Absolute-value alarm (SV) 9: Absolute-value alarm (SV) (with Hold) 10: Absolute-value alarm (SV) (with Latch) 11: Absolute-value alarm (SV) (with Hold and Latch) 12: Absolute-value alarm (MV) 13: Absolute-value alarm (MV) (with Hold) 14: Absolute-value alarm (MV) (with Latch) 15: Absolute-value alarm (MV) (with Hold and Latch)	Y	Y	0		
J622	(Upper level alarm (AH))	OFF: Disable -999.00 to 0.00 to 9990.00 *6	Y	Y	OFF		
J624	(Lower level alarm (AL))	OFF: Disable -999.00 to 0.00 to 9990.00 *6	Y	Y	OFF		
J627	(Feedback error detection mode)	0: Disable (Turns ON output signals (EPV2-ERR) and continues operation.) 1: Enable (Free run stop (PVb trip)) 2: Enable (Deceleration and stop (PVb trip))	Y	Y	0		
J629	(Feedback error upper-limit)	Auto: 105% equivalent -999.00 to 0.00 to 9990.00 *6	Y	Y	Auto		
J630	(Feedback error lower-limit)	Auto: -5% equivalent -999.00 to 0.00 to 9990.00 *6	Y	Y	Auto		
J631	(Feedback error detection time)	0.0 to 300.0 s	Y	Y	0.1		
J640	(Manual command)	0: Keypad (☒☒ key) 8: Keypad (☒☒ key) (Balanceless-bumpless) 51: External PID manual command 1(Analog input: Terminals [12], [C1] and [V2]) 52: External PID manual command 2(Analog input: Terminals [12], [C1] and [V2]) 111: Apply external PID control 1 manual command	N	Y	0		
J651	External PID Control 3 (Mode selection)	0: Disable 1: Enable process control (Normal operation) 2: Enable process control (Inverse operation) 11: Enable process control, interlocking with inverter running (Normal operation) 12: Enable process control, interlocking with inverter running (Inverse operation) 21: Enable process control by external digital signal (Normal operation) 22: Enable process control by external digital signal (Inverse operation) 31: Enable process control by external digital signal, interlocking with inverter running (Normal operation) 32: Enable process control by external digital signal, interlocking with inverter running (Inverse operation)	N	Y	0		

*6 The upper and lower level values are restricted by the maximum and minimum scales.

Code	Name	Data setting range	Change when running	Data copying	Default setting	Related page
J652	External PID Control 3 (Remote command selection)	0: Keypad (ⓧⓧ key) 3: UP/DOWN 4: Command via communications link (Use function code S32) 51: External PID process command 1 (Analog input: Terminals [12], [C1] and [V2]) 52: External PID process command 2 (Analog input: Terminals [12], [C1] and [V2]) 53: External PID process command 3 (Analog input: Terminals [12], [C1] and [V2]) 111: Apply external PID control 1 commands 112: Apply external PID control 2 commands	N	Y	0	6-247
J653	(Feedback selection)	51: External PID feedback value 1 52: External PID feedback value 2 53: External PID feedback value 3	N	Y	53	
J655	(Display unit)	See J605.	N	Y	0	
J656	(Maximum scale)	-999.00 to 0.00 to 9990.00	N	Y	100	
J657	(Minimum scale)	-999.00 to 0.00 to 9990.00	N	Y	0.00	
J660	P (Gain)	ON/OFF: ON/OFF control 0.000 to 30.000 times	Y	Y	0.100	
J661	I (Integral time)	0.0 to 3600.0 s	Y	Y	0.0	
J662	D (Differential time)	0.00 to 600.00 s	Y	Y	0.00	
J663	(Feedback filter)	0.0 to 900.0 s	Y	Y	0.5	
J664	(Anti-reset wind-up)	OFF: Disable 0.00 to 9990.00 *6	Y	Y	OFF	
J665	(ON/OFF control hysteresis width)	0.00 to 9990.00 *6	Y	Y	0.00	
J666	(Proportional operation output convergent value)	0 to 150%	Y	Y	0	
J667	(Proportion cycle)	1 to 150 s	Y	Y	30	6-248
J668	(Upper limit of PID process output)	-10 to +110%	Y	Y	100	
J669	(Lower limit of PID process output)	-10 to +110%	Y	Y	0	
J670	(Upper and lower limits)	0: Limit PID output with J618, J619 1: 110%, -10% of PID output with J618 exceeded or less than J619	Y	Y	0	
J671	(Alarm output selection)	0: Absolute-value alarm (PV) 1: Absolute-value alarm (PV) (with Hold) 2: Absolute-value alarm (PV) (with Latch) 3: Absolute-value alarm (PV) (with Hold and Latch) 4: Deviation alarm 5: Deviation alarm (PV) (with Hold) 6: Deviation alarm (PV) (with Latch) 7: Deviation alarm (PV) (with Hold and Latch) 8: Absolute-value alarm (SV) 9: Absolute-value alarm (SV) (with Hold) 10: Absolute-value alarm (SV) (with Latch) 11: Absolute-value alarm (SV) (with Hold and Latch) 12: Absolute-value alarm (MV) 13: Absolute-value alarm (MV) (with Hold) 14: Absolute-value alarm (MV) (with Latch) 15: Absolute-value alarm (MV) (with Hold and Latch)	Y	Y	0	
J672	(Upper level alarm (AH))	OFF: Disable -999.00 to 0.00 to 9990.00 *6	Y	Y	OFF	
J674	(Lower level alarm (AL))	OFF: Disable -999.00 to 0.00 to 9990.00 *6	Y	Y	OFF	
J677	(Feedback error detection mode)	0: Disable (Turns ON output signals (EPV3-ERR) and continues operation.) 1: Enable (Free run stop (PVC trip)) 2: Enable (Deceleration and stop (PVC trip))	Y	Y	0	
J679	(Feedback error upper-limit)	Auto: 105% equivalent -999.00 to 0.00 to 9990.00 *6	Y	Y	Auto	
J680	(Feedback error lower-limit)	Auto: -5% equivalent -999.00 to 0.00 to 9990.00 *6	Y	Y	Auto	
J681	(Feedback error detection time)	0.0 to 300.0 s	Y	Y	0.1	
J690	(Manual commands)	0: Keypad (ⓧⓧ key) 8: Keypad (ⓧⓧ key) (Balanceless-bumpless) 51: External PID manual command 1 (Analog input: Terminals [12], [C1] and [V2]) 52: External PID manual command 2 (Analog input: Terminals [12], [C1] and [V2]) 53: External PID manual command 3 (Analog input: Terminals [12], [C1] and [V2]) 111: Apply external PID control 1 manual commands 112: Apply external PID control 2 manual commands	N	Y	0	

*6 The upper and lower level values are restricted by the maximum and minimum scales.

d codes: Application Functions 2

Code	Name	Data setting range	Change when running	Data copying	Default setting	Related page
d51	Reserved *5	0 to 500	N	Y	*8	6-249
d55	Reserved *5	0000H to 00FFH	N	Y	0	
d69	Reserved *5	30.0 to 100.0 Hz	Y	Y	30.0	
d98	Reserved *5	0000H to FFFFH	Y	Y	0	
d99	Reserved *5	0 to 3	Y	Y	0	

*5 These function codes are reserved for particular manufacturers. Unless otherwise specified, do not access these function codes.

*8 "5" for inverters of 5 HP or below, "10" for those of 7.5 to 30 HP, "20" for those of 40 HP or above.

U codes: Customizable Logic Function

Code	Name	Data setting range	Change when running	Data copying	Default setting	Related page
U00	Customizable Logic (Mode selection)	0: Disable 1: Enable (Customizable logic operation) Changing this code data from "1" to "0" causes an ECL alarm.	Y	Y	0	6-249
U01	Customizable Logic: Step 1 (Control function)	0: No function assigned 10: Through output + General-purpose timer 20: ANDing + General-purpose timer 30: ORing + General-purpose timer 40: XORing + General-purpose timer 50: Set priority flip-flop + General-purpose timer 60: Reset priority flip-flop + General-purpose timer 70: Rising edge detector + General-purpose timer 80: Falling edge detector + General-purpose timer 90: Rising & falling edges detector + General-purpose timer 100: Hold + General-purpose timer 110: Increment counter 120: Decrement counter 130: Timer with reset input 2001-3002: Analog input 4001-5114: Analog + digital	N	Y	0	
U02 U03	(Input 1)	0 (1000): Inverter running (<i>RUN</i>) 1 (1001): Frequency (speed) arrival signal (<i>FAR</i>) 2 (1002): Frequency (speed) detected (<i>FDT</i>) 3 (1003): Undervoltage detected (Inverter stopped) (<i>LU</i>) 5 (1005): Inverter output limiting (<i>IOL</i>) 6 (1006): Auto-restarting after momentary power failure (<i>IPF</i>) 7 (1007): Motor overload early warning (<i>OL</i>) 10 (1010): Inverter ready to run (<i>RDY</i>) 11: Switch motor drive source between commercial power and inverter output (For MC on commercial line) (<i>SW88</i>) 12: Switch motor drive source between commercial power and inverter output (For secondary side) (<i>SW52-2</i>) 13: Switch motor drive source between commercial power and inverter output (For primary side) (<i>SW52-1</i>) 15 (1015): Select AX terminal function (For MC on primary side) (<i>AX</i>) 16 (1016): Shifted to pattern operation stage (<i>TU</i>) 17 (1017): Pattern operation cycle completed (<i>TO</i>) 18 (1018): Pattern operation stage number (<i>STG1</i>) 19 (1019): Pattern operation stage number (<i>STG2</i>) 20 (1020): Pattern operation stage number (<i>STG4</i>) 22 (1022): Inverter output limiting with delay (<i>IOL2</i>) 25 (1025): Cooling fan in operation (<i>FAN</i>) 26 (1026): Auto-resetting (<i>TRY</i>) 28 (1028): Heat sink overheat early warning (<i>OH</i>) 30 (1030): Lifetime alarm (<i>LIFE</i>) 33 (1033): Reference loss detected (<i>REF OFF</i>) 35 (1035): Inverter output on (<i>RUN2</i>) 36 (1036): Overload prevention control (<i>OLP</i>) 37 (1037): Current detected (<i>ID</i>) 38 (1038): Current detected 2 (<i>ID2</i>) *10 42 (1042): PID alarm (<i>PID-ALM</i>) 43 (1043): Under PID control (<i>PID-CTL</i>) 44 (1044): Motor stopped due to slow flowrate under PID control (<i>PID-STP</i>)* 45 (1045): Low output torque detected (<i>U-TL</i>) 52 (1052): Running forward (<i>FRUN</i>) 53 (1053): Running reverse (<i>RRUN</i>)	N	Y	100	

* Available in the ROM version 1600 or later.

*10 Available at ROM version 2450 or later.

Code	Name	Data setting range	Change when running	Data copying	Default setting	Related page
		54 (1054): In remote operation (RMT)				6-249
		55 (1055): Run command entered (AX2)				
		56 (1056): Motor overheat detected by thermistor (THM)				
		59 (1059): Terminal [C1] wire break (C1OFF)				
		84 (1084): Maintenance timer (MNT)				
		87(1087): Frequency arrival signal (FARFDT)				
		95(1095): Running in fire mode (FMRUN)				
		98 (1098): Light alarm (L-ALM)				
		99 (1099): Alarm output (for any alarm) (ALM)				
		101(1101): EN terminal detection circuit error (DECFF)				
		102(1102): EN terminal OFF (ENOFF)				
		190 (1190): In timer operation (TMD)				
		191 (1191): Timer 1 enabled (TMD1)				
		192 (1192): Timer 2 enabled (TMD2)				
		193 (1193): Timer 3 enabled (TMD3)				
		194 (1194): Timer 4 enabled (TMD4)				
		200 (1200): Under PID2 control (PID2)				
		201 (1201): PID1 alarm (PV1-ALM)				
		202 (1202): PID1 feedback error (PV1-OFF)				
		203 (1203): PID2 alarm (PV2-ALM)				
		204 (1204): PID2 feedback error (PV2-OFF)				
		211 (1211): Under external PID1 control (EPID1-CTL)				
		212 (1212): External PID1 output (EPID1-OUT)				
		213 (1213): External PID1 output (EPID1-RUN)				
		214 (1214): External PID1 alarm (EPV1-ALM)				
		215 (1215): External PID1 feedback error (EPV1-OFF)				
		221 (1221): Under external PID2 control (EPID2-CTL)				
		222 (1222): External PID2 output (EPID2-OUT)				
		223 (1223): External PID2 output (EPID2-RUN)				
		224 (1224): External PID2 alarm (EPV2-ALM)				
		225 (1225): External PID2 feedback error (EPV2-OFF)				
		231 (1231): Under external PID3 control (EPID3-CTL)				
		232 (1232): External PID3 output (EPID3-OUT)				
		233 (1233): External PID3 output (EPID3-RUN)				
		234 (1234): External PID3 alarm (EPV3-ALM)				
		235 (1235): External PID3 feedback error (EPV3-OFF)				
		2001 (3001): Output of step 1 (SO01)				
		2002 (3002): Output of step 2 (SO02)				
		2003 (3003): Output of step 3 (SO03)				
		2004 (3004): Output of step 4 (SO04)				
		2005 (3005): Output of step 5 (SO05)				
		2006 (3006): Output of step 6 (SO06)				
		2007 (3007): Output of step 7 (SO07)				
		2008 (3008): Output of step 8 (SO08)				
		2009 (3009): Output of step 9 (SO09)				
		2010 (3010): Output of step 10 (SO10)				
		2011 (3011): Output of step 11 (SO11)				
		2012 (3012): Output of step 12 (SO12)				
		2013 (3013): Output of step 13 (SO13)				
		2014 (3014): Output of step 14 (SO14)				
		4001 (5001): Terminal [X1] input signal (X1)				
		4002 (5002): Terminal [X2] input signal (X2)				
		4003 (5003): Terminal [X3] input signal (X3)				
		4004 (5004): Terminal [X4] input signal (X4)				
		4005 (5005): Terminal [X5] input signal (X5)				
		4006 (5006): Terminal [X6] input signal (X6)				
		4007 (5007): Terminal [X7] input signal (X7)				
		4010 (5010): Terminal [FWD] input signal (FWD)				
		4011 (5011): Terminal [REV] input signal (REV)				
		6000 (7000): Final run command (FL_RUN)				
		6001 (7001): Final FWD run command (FL_FWD)				
		6002 (7002): Final REV run command (FL_REV)				
		6003 (7003): During acceleration (DACC)				
		6004 (7004): During deceleration (DDEC)				
		6005 (7005): Under anti-regenerative control (REGA)				
		6007 (7007): Alarm factor presence (ALM_ACT)				

Code	Name	Data setting range	Change when running	Data copying	Default setting	Related page
		[Analog] 8000 to 8085: The value with 8000 added to F31 9001: Analog 12 terminal input signal [12] 9002: Analog C1 terminal input signal [C1] (C1) 9003: Analog V2 terminal input signal [C1] (V2) *9004: Analog 32 terminal input signal [32] *9005: Analog C2 terminal input signal [C2] *9006: RTD1 [PT1] *9007: RTD2 [PT2] Setting the value in parentheses () shown above assigns a negative logic output to a terminal. (True if OFF.) Setting the value of 1000s in parentheses () shown above assigns a negative logic input to a terminal.				6-249
U04	(Function 1)	-9990.00 to 0.00 to 9990.00	N	Y	0.00	
U05	(Function 2)		N	Y	0.00	
U06	Customizable Logic: Step 2 (Control function)	See U01.	N	Y	0	
U07	(Input 1)	See U02.	N	Y	0	
U08	(Input 2)	See U02.	N	Y	0	
U09	(Function 1)	-9990.00 to 0.00 to 9990.00	N	Y	0.00	
U10	(Function 2)	-9990.00 to 0.00 to 9990.00	N	Y	0.00	
U11	Customizable Logic: Step 3 (Control function)	See U01.	N	Y	0	
U12	(Input 1)	See U02.	N	Y	0	
U13	(Input 2)	See U02.	N	Y	0	
U14	(Function 1)	-9990.00 to 0.00 to 9990.00	N	Y	0.00	
U15	(Function 2)	-9990.00 to 0.00 to 9990.00	N	Y	0.00	
U16	Customizable Logic: Step 4 (Control function)	See U01.	N	Y	0	
U17	(Input 1)	See U02.	N	Y	0	
U18	(Input 2)	See U02.	N	Y	0	
U19	(Function 1)	-9990.00 to 0.00 to 9990.00	N	Y	0.00	
U20	(Function 2)	-9990.00 to 0.00 to 9990.00	N	Y	0.00	
U21	Customizable Logic: Step 5 (Control function)	See U01.	N	Y	0	
U22	(Input 1)	See U02.	N	Y	0	
U23	(Input 2)	See U02.	N	Y	0	
U24	(Function 1)	-9990.00 to 0.00 to 9990.00	N	Y	0.00	
U25	(Function 2)	-9990.00 to 0.00 to 9990.00	N	Y	0.00	
U26	Customizable Logic: Step 6 (Control function)	See U01.	N	Y	0	
U27	(Input 1)	See U02.	N	Y	0	
U28	(Input 2)	See U02.	N	Y	0	
U29	(Function 1)	-9990.00 to 0.00 to 9990.00	N	Y	0.00	
U30	(Function 2)	-9990.00 to 0.00 to 9990.00	N	Y	0.00	
U31	Customizable Logic: Step 7 (Control function)	See U01.	N	Y	0	
U32	(Input 1)	See U02.	N	Y	0	
U33	(Input 2)	See U02.	N	Y	0	
U34	(Function 1)	-9990.00 to 0.00 to 9990.00	N	Y	0.00	
U35	(Function 2)	-9990.00 to 0.00 to 9990.00	N	Y	0.00	

*: The use of the option card lets those functions remain in effect.

Code	Name	Data setting range	Change when running	Data copying	Default setting	Related page
U36	Customizable Logic: Step 8 (Control function)	See U01.	N	Y	0	6-249
U37	(Input 1)	See U02.	N	Y	0	
U38	(Input 2)	See U02.	N	Y	0	
U39	(Function 1)	-9990.00 to 0.00 to 9990.00	N	Y	0.00	
U40	(Function 2)	-9990.00 to 0.00 to 9990.00	N	Y	0.00	
U41	Customizable Logic: Step 9 (Control function)	See U01.	N	Y	0	
U42	(Input 1)	See U02.	N	Y	0	
U43	(Input 2)	See U02.	N	Y	0	
U44	(Function 1)	-9990.00 to 0.00 to 9990.00	N	Y	0.00	
U45	(Function 2)	-9990.00 to 0.00 to 9990.00	N	Y	0.00	
U46	Customizable Logic: Step 10 (Control function)	See U01.	N	Y	0	
U47	(Input 1)	See U02.	N	Y	0	
U48	(Input 2)	See U02.	N	Y	0	
U49	(Function 1)	-9990.00 to 0.00 to 9990.00	N	Y	0.00	
U50	(Function 2)	-9990.00 to 0.00 to 9990.00	N	Y	0.00	
U51	Customizable Logic: Step 11 (Control function)	See U01.	N	Y	0	
U52	(Input 1)	See U02.	N	Y	0	
U53	(Input 2)	See U02.	N	Y	0	
U54	(Function 1)	-9990.00 to 0.00 to 9990.00	N	Y	0.00	
U55	(Function 2)	-9990.00 to 0.00 to 9990.00	N	Y	0.00	
U56	Customizable Logic: Step 12 (Control function)	See U01.	N	Y	0	
U57	(Input 1)	See U02.	N	Y	0	
U58	(Input 2)	See U02.	N	Y	0	
U59	(Function 1)	-9990.00 to 0.00 to 9990.00	N	Y	0.00	
U60	(Function 2)	-9990.00 to 0.00 to 9990.00	N	Y	0.00	
U61	Customizable Logic: Step 13 (Control function)	See U01.	N	Y	0	
U62	(Input 1)	See U02.	N	Y	0	
U63	(Input 2)	See U02.	N	Y	0	
U64	(Function 1)	-9990.00 to 0.00 to 9990.00	N	Y	0.00	
U65	(Function 2)	-9990.00 to 0.00 to 9990.00	N	Y	0.00	
U66	Customizable Logic: Step 14 (Control function)	See U01.	N	Y	0	
U67	(Input 1)	See U02.	N	Y	0	
U68	(Input 2)	See U02.	N	Y	0	
U69	(Function 1)	-9990.00 to 0.00 to 9990.00	N	Y	0.00	
U70	(Function 2)	-9990.00 to 0.00 to 9990.00	N	Y	0.00	
U71	Customizable Logic Output Signal 1 (Output selection)	0: Disable 1: Output of step 1 2: Output of step 2 3: Output of step 3 4: Output of step 4 5: Output of step 5 6: Output of step 6 7: Output of step 7 8: Output of step 8 9: Output of step 9 10: Output of step 10 11: Output of step 11 12: Output of step 12 13: Output of step 13 14: Output of step 14	(SO01) (SO02) (SO03) (SO04) (SO05) (SO06) (SO07) (SO08) (SO09) (SO10) (SO11) (SO12) (SO13) (SO14)	N	Y	0
U72	Customizable Logic Output Signal 2	0 (1000): Select multistep frequency (0 to 1 step)	(SS1)	N	Y	100
U73	Customizable Logic Output Signal 3	1 (1001): Select multistep frequency (0 to 3 steps)	(SS2)	N	Y	100
U74	Customizable Logic Output Signal 4	2 (1002): Select multistep frequency (0 to 7 steps)	(SS4)	N	Y	100
U75	Customizable Logic Output Signal 5	3 (1003): Select multistep frequency (0 to 15 steps)	(SS8)	N	Y	100
U76	Customizable Logic Output Signal 6	4 (1004): Select ACC/DEC time (2 steps)	(RT1)	N	Y	100
U77	Customizable Logic Output Signal 7	5 (1005): Select ACC/DEC time (4 steps)	(RT2)	N	Y	100
U81	Customizable Logic Output Signal 1 (Function selection)	6 (1006): Enable 3-wire operation 7 (1007): Coast to a stop 8 (1008): Reset alarm 9 (1009): Enable external alarm trip (9 = Active OFF, 1009 = Active ON) 11 (1011): Select frequency command 2/1 13: Enable DC braking 14 (1014): Select torque limiter level 2/1 15: Switch to commercial power (50 Hz) 16: Switch to commercial power (60 Hz)	(HLD) (BX) (RST) (THR) (Hz2/Hz1) (DCBRK) (TL2/TL1) (SW50) (SW60)	N	Y	100
U82	Customizable Logic Output Signal 2			N	Y	100
U83	Customizable Logic Output Signal 3			N	Y	100
U84	Customizable Logic Output Signal 4			N	Y	100
U85	Customizable Logic Output Signal 5			N	Y	100
U86	Customizable Logic Output Signal 6			N	Y	100
U87	Customizable Logic Output Signal 7			N	Y	100

Code	Name	Data setting range	Change when running	Data copying	Default setting	Related page
		17 (1017): UP (Increase output frequency) (UP)				6-249
		18 (1018): DOWN (Decrease output frequency) (DOWN)				
		20 (1020): Cancel PID control (Hz/PID)				
		21 (1021): Switch normal/inverse operation (IVS)				
		22 (1022): Interlock (IL)				
		24 (1024): Enable communications link via RS-485 or fieldbus (LE)				
		25 (1025): Universal DI (U-DI)				
		26 (1026): Enable auto search for idling motor speed at starting (STM)				
		30 (1030): Force to stop (STOP) (30 = Active OFF, 1030 = Active ON)				
		33 (1033): Reset PID integral and differential components (PID-RST)				
		34 (1034): Hold PID integral component (PID-HLD)				
		35 (1035): Select local (keypad) operation (LOC)				
		38 (1038): Enable run commands (RE)				
		39: Protect motor from dew condensation (DWP)				
		40: Enable integrated sequence to switch to commercial power (50 Hz) (ISW50)				
		41: Enable integrated sequence to switch to commercial power (60 Hz) (ISW60)				
		58 (1058): Reset UP/DOWN frequency (STZ)				
		72 (1072): Count the run time of commercial power-driven motor 1 (CRUN-M1)				
		81 (1081): Clear all customizable logic timers (CLTC)				
		87 (1087): Run command 2/1 (FR2/FR1)				
		88: Run forward 2 (FWD2)				
		89: Run reverse 2 (REV2)				
		98: Run forward (FWD)				
		99: Run reverse (REV)				
		100: No function assigned (NONE)				
		131 (1131): Flowrate switch (FS)*				
		132 (1132): Filter clogging reverse rotation command (FRC)				
		133 (1133): Switch PID channel (PID2/1)				
		171 (1171): PID multistep command (PID-SS1)				
		172 (1172): PID multistep command (PID-SS2)				
		181 (1181): External PID multistep command (EPID-SS1)				
		182 (1182): External PID multistep command (EPID-SS2)				
		190 (1190): Cancel timer (TMC)				
		191 (1191): Enable timer 1 (TM1)				
		192 (1192): Enable timer 2 (TM2)				
		193 (1193): Enable timer 3 (TM3)				
		194 (1194): Enable timer 4 (TM4)				
		201 (1201): External PID control 1 ON command (EPID1-ON)				
		202 (1202): Cancel external PID control 1 (%/EPID1)				
		203 (1203): Switch normal/inverse operation under external PID control 1 (EPID1-IVS)				
		204 (1204): Reset external PID1 integral and differential components (EPID1-RST)				
		205 (1205): Hold external PID1 integral component (EPID1-HLD)				
		211 (1211): External PID control 2 ON command (EPID2-ON)				
		212 (1212): Cancel external PID control 2 (%/EPID2)				
		213 (1213): Switch normal/inverse operation under external PID control 2 (EPID2-IVS)				
		214 (1214): Reset external PID2 integral and differential components (EPID2-RST)				
		215 (1215): Hold external PID2 integral component (EPID2-HLD)				
		221 (1221): External PID control 3 ON command (EPID3-ON)				
		222 (1222): Cancel external PID control 3 (%/EPID3)				
		223 (1223): Switch normal/inverse operation under external PID control 3 (EPID3-IVS)				
		224 (1224): Reset external PID3 integral and differential components (EPID3-RST)				
		225 (1225): Hold external PID3 integral component (EPID3-HLD)				
		8001: Auxiliary frequency command 1				
		8002: Auxiliary frequency command 2				
		8003: PID process command 1				
		8004: PID process command 2				

* Available in the ROM version 1500 or later.

Code	Name	Data setting range	Change when running	Data copying	Default setting	Related page
		8005: PID feedback value 1 8012: Acceleration/deceleration time ratio setting 8013: Upper limit frequency 8014: Lower limit frequency 8030: PID feedback value 2 8031: Auxiliary input 1 to PID process command 8032: Auxiliary input 2 to PID process command 8033: Flowrate sensor* 8041: External PID process command 1 8042: External PID feedback value 1 8043: External PID manual command 1 8044: External PID process command 2 8045: External PID feedback value 2 8046: External PID manual command 2 8047: External PID process command 3 8048: External PID feedback value 3 8049: External PID manual command 3 Setting the value of 1000s in parentheses () shown above assigns a negative logic input to a terminal.				6-249
U91	Customizable Logic Timer Monitor (Step selection)	0: Disable monitoring 1: Step 1 2: Step 2 3: Step 3 4: Step 4 5: Step 5 6: Step 6 7: Step 7 8: Step 8 9: Step 9 10: Step 10 11: Step 11 12: Step 12 13: Step 13 14: Step 14	Y	Y	1	
U92	Customizable Logic Calculation Coefficient (Mantissa of calculation coefficient K_{A1})	-9.999 to 9.999	N	Y	0.00	
U93	(Exponent of calculation coefficient K_{A1})	-5 to 5	N	Y	0	
U94	(Mantissa of calculation coefficient K_{B1})	-9.999 to 9.999	N	Y	0.00	
U95	(Exponent of calculation coefficient K_{B1})	-5 to 5	N	Y	0.	
U96	(Mantissa of calculation coefficient K_{C1})	-9.999 to 9.999	N	Y	0.00	
U97	(Exponent of calculation coefficient K_{C1})	-5 to 5	N	Y	0	

U1 codes: Custom Logic Function

Code	Name	Data setting range	Change when running	Data copying	Default setting	Related page
U101	Customizable Logic Conversion point 1 (X1)	-999.00 to 0.00 to 9990.00	Y	Y	0.00	6-270
U102	(Y1)		Y	Y	0.00	
U103	Conversion point 2 (X2)		Y	Y	0.00	
U104	(Y2)		Y	Y	0.00	
U105	Conversion point 3 (X3)		Y	Y	0.00	
U106	(Y3)		Y	Y	0.00	
U107	Automatic Calculation of Conversion Coefficients (X3)		0: Disable 1: Execute calculation (Conversion 1)	N	Y	

* Available in the ROM version 1500 or later.

y codes: Link Functions

Code	Name	Data setting range	Change when running	Data copying	Default setting	Related page
y01	RS-485 Communication 1 (Station address)	0 to 255 * Set 1 when other than BACnet is 0. * Set 127 when BACnet is 128 or above.	N	Y	1	6-275
y02	(Communications error processing)	0: Immediately trip with alarm Er8 1: Trip with alarm Er8 after running for the period specified by timer y03 2: Retry during the period specified by timer y03. If the retry fails, trip with alarm Er8. If it succeeds, continue to run. 3: Continue to run	Y	Y	0	
y03	(Timer)	0.0 to 60.0 s	Y	Y	2.0	
y04	(Baud rate)	0: 2400 bps 1: 4800 bps 2: 9600 bps 3: 19200 bps 4: 38400 bps 6: 76800 bps (Dedicated for BACnet protocol) *10	Y	Y	3	
y05	(Data length)	0: 8 bits 1: 7 bits	Y	Y	0	
y06	(Parity check)	0: None (2 stop bits) 1: Even parity (1 stop bit) 2: Odd parity (1 stop bit) 3: None (1 stop bit)	Y	Y	0	
y07	(Stop bits)	0: 2 bits 1: 1 bit	Y	Y	0	
y08	(No-response error detection time)	OFF: No detection, 1 to 60 s	Y	Y	OFF	
y09	(Response interval)	0.00 to 1.00 s	Y	Y	0.01	
y10	(Protocol selection)	0: Modbus RTU protocol 1: SX protocol (loader protocol) 2: Fuji general-purpose inverter protocol 3: Metasys N2 protocol 5: BACnet protocol	Y	Y	1	
y11	RS-485 Communication 2 (Station address)	0 to 255	N	Y	1	6-278
y12	(Communications error processing)	0: Immediately trip with alarm ErP 1: Trip with alarm ErP after running for the period specified by timer y13 2: Retry during the period specified by timer y13. If the retry fails, trip with alarm ErP. If it succeeds, continue to run. 3: Continue to run	Y	Y	0	
y13	(Timer)	0.0 to 60.0 s	Y	Y	2.0	
y14	(Baud rate)	0: 2400 bps 1: 4800 bps 2: 9600 bps 3: 19200 bps 4: 38400 bps 6: 76800 bps (Dedicated for BACnet protocol) *10	Y	Y	3	
y15	(Data length)	0: 8 bits 1: 7 bits	Y	Y	0	
y16	(Parity check)	0: None (2 stop bits) 1: Even parity (1 stop bit) 2: Odd parity (1 stop bit) 3: None (1 stop bit)	Y	Y	0	
y17	(Stop bits)	0: 2 bits 1: 1 bit	Y	Y	0	
y18	(No-response error detection time)	OFF: No detection, 1 to 60 s	Y	Y	OFF	
y19	(Response interval)	0.00 to 1.00 s	Y	Y	0.01	
y20	(Protocol selection)	0: Modbus RTU protocol 1: SX protocol (loader protocol) 2: Fuji general-purpose inverter protocol 3: Metasys N2 protocol 5: BACnet protocol	Y	Y	0	
y60	BACnet Device instance number (Upper) *9	0 to 4194	N	Y	37	6-278
y61	(Lower) *9	0: Compatible with present version, 128 to 999	N	Y	0	
y95	Data Clear Processing for Communications Error	0: Do not clear the data of function codes Sxx when a communications error occurs. (compatible with the conventional inverters) 1: Clear the data of function codes S01/S05/S19 when a communications error occurs. 2: Clear the run command assigned bit of function code S06 when a communications error occurs. 3: Clear both data of S01/S05/S19 and run command assigned bit of S06 when a communications error occurs. * Related alarms: Er8, ErP, Er4, Er5, ErU	Y	Y	0	

*9 Available at ROM version 2100 or later.

*10 Available at ROM version 2450 or later.



Code	Name	Data setting range	Change when running	Data copying	Default setting	Related page	
y98	Bus Link Function (Mode selection)	Frequency command 0: Follow H30 data 1: Via fieldbus option 2: Follow H30 data 3: Via fieldbus option	Run command Follow H30 data Follow H30 data Via fieldbus option Via fieldbus option	Y	Y	0	6-279
y99	Loader Link Function (Mode selection)	Frequency command 0: Follow H30 and y98 data 1: Via RS-485 link (FRENIC Loader) 2: Follow H30 and y98 data 3: Via RS-485 link (FRENIC Loader)	Run command Follow H30 and y98 data Follow H30 and y98 data Via RS-485 link (FRENIC Loader) Via RS-485 link (FRENIC Loader)	Y	N	0	

T codes: Timer Functions

Code	Name	Data setting range	Change when running	Data copying	Default setting	Related page
T01	Timer 1 Operation (Operating mode)	0: Disable 1: Enable (Run inverter) 2: Enable (Output digital signal) 3: Enable (Run inverter + Output digital signal)	N	Y	0	6-280
T02	(Start time)	Possible to specify in the special menu.	N	Y	0	6-281
T03	(End time)	Possible to specify in the special menu.	N	Y	0	
T04	(Start day of the week)	Possible to specify in the special menu.	N	Y	0	
T06	Timer 2 Operation (Operating mode)	Same as T01.	N	Y	0	6-282
T07	(Start time)	Possible to specify in the special menu.	N	Y	0	
T08	(End time)	Possible to specify in the special menu.	N	Y	0	
T09	(Start day of the week)	Possible to specify in the special menu.	N	Y	0	
T11	Timer 3 Operation (Operating mode)	Same as T01.	N	Y	0	
T12	(Start time)	Possible to specify in the special menu.	N	Y	0	
T13	(End time)	Possible to specify in the special menu.	N	Y	0	
T14	(Start day of the week)	Possible to specify in the special menu.	N	Y	0	
T16	Timer 4 Operation (Operating mode)	Same as T01.	N	Y	0	
T17	(Start time)	Possible to specify in the special menu.	N	Y	0	
T18	(End time)	Possible to specify in the special menu.	N	Y	0	
T19	(Start day of the week)	Possible to specify in the special menu.	N	Y	0	
T51	Timer Operation (Pause date 1)	Possible to specify in the special menu.	N	Y	2210H	6-283
T52	(Pause date 2)		N	Y	2210H	
T53	(Pause date 3)		N	Y	2210H	
T54	(Pause date 4)		N	Y	2210H	
T55	(Pause date 5)		N	Y	2210H	
T56	(Pause date 6)		N	Y	2210H	
T57	(Pause date 7)		N	Y	2210H	
T58	(Pause date 8)		N	Y	2210H	
T59	(Pause date 9)		N	Y	2210H	
T60	(Pause date 10)		N	Y	2210H	
T61	(Pause date 11)		N	Y	2210H	
T62	(Pause date 12)		N	Y	2210H	
T63	(Pause date 13)		N	Y	2210H	
T64	(Pause date 14)		N	Y	2210H	
T65	(Pause date 15)		N	Y	2210H	
T66	(Pause date 16)		N	Y	2210H	
T67	(Pause date 17)		N	Y	2210H	
T68	(Pause date 18)		N	Y	2210H	
T69	(Pause date 19)		N	Y	2210H	
T70	(Pause date 20)		N	Y	2210H	

K codes: Keypad Functions

Code	Name	Data setting range	Change when running	Data copying	Default setting	Related page
K01	LCD Monitor (Language selection)	0: Japanese 1: English 2: German 3: French 4: Spanish 5: Italian 6: Chinese 8: Russian (Available soon) 9: Greek (Available soon) 10: Turkish (Available soon) 11: Polish 12: Czech 13: Swedish 14: Portuguese (Available soon) 15: Dutch (Available soon) 16: Malay 17: Vietnamese (Available soon) 18: Thai (Available soon) 19: Indonesian (Available soon) 100: User-customized language (Available soon)	Y	Y	1	6-284
K02	Backlight OFF Time	OFF: Always OFF 1 to 30 min.: Automatic OFF time	Y	Y	5	
K03	LCD Monitor (Backlight brightness control)	0 (Dark) to 10 (Light)	Y	Y	5	6-285
K04	(Contrast control)	0 (Light) to 10 (Dark)	Y	Y	5	
K08	LCD Monitor Status Display/Hide Selection	0: Hide 1: Display	Y	Y	1	
K10	Main Monitor (Display item selection)	0: Speed monitor (select by K11) 13: Output current 14: Output voltage 18: Calculated torque 19: Input power 25: Load factor 26: Motor output 27: Analog input monitor in physical quantity 35: Input watt-hour (The unit depends on K31.) 50: PID command (final) in physical quantity 51: PID feedback amount (final) in physical quantity 52: PID output 53: PID control 1 command in physical quantity 54: PID control 1 feedback amount in physical quantity 55: PID control 2 command in physical quantity 56: PID control 2 feedback amount in physical quantity 60: External PID control 1 command (final) in physical quantity 61: External PID control 1 feedback amount (final) in physical quantity 62: External PID control 1 output in % 63: External PID control 1 manual command in % 64: External PID control 1 command in physical quantity 65: External PID control 1 feedback amount in physical quantity 70: External PID control 2 command in physical quantity 71: External PID control 2 feedback amount in physical quantity 72: External PID control 2 output in % 73: External PID control 2 manual command in % 80: External PID control 3 command in physical quantity 81: External PID control 3 feedback amount in physical quantity 82: External PID control 3 output in % 83: External PID control 3 manual command in %	Y	Y	0	6-286
K11	Main Monitor (Speed monitor item)	1: Output frequency 1 (before slip compensation) 2: Output frequency 2 (after slip compensation) 3: Reference frequency 4: Motor speed in r/min 5: Load shaft speed in r/min 8: Display speed in %	Y	Y	1	6-289

Code	Name	Data setting range	Change when running	Data copying	Default setting	Related page
K12	Main Monitor (Display when stopped)	0: Reference value 1: Output value	Y	Y	0	6-289
K15	Sub Monitor (Display type)	0: Numeric values 1: Bar charts	Y	Y	0	6-290
K16	Sub Monitor 1 (Display item selection)	*Refer to K10 (= 13 to 83) and K11 (= 1 to 8).	Y	Y	13	6-291
K17	Sub Monitor 2 (Display item selection)		Y	Y	19	
K20	Bar Chart 1 (Display item selection)	1: Output frequency 1 (before slip compensation)	Y	Y	1	6-291
K21	Bar Chart 2 (Display item selection)	13: Output current 14: Output voltage	Y	Y	13	
K22	Bar Chart 3 (Display item selection)	18: Calculated torque 19: Input power 25: Load factor 26: Motor output	Y	Y	19	
K29	Display Filter	0.0 to 5.0 s	Y	Y	0.5	6-292
K30	Coefficient for Speed Indication	0.01 to 200.00	Y	Y	30.00	
K31	Display Unit for Input Watt-hour Data	0: kWh 1: MWh	Y	Y	0	
K32	Display Coefficient for Input Watt-hour Data	OFF: Cancel or reset 0.001 to 9999.000	Y	Y	0.010	6-293
K33	Long-term, Input Watt-hour Data Monitor	OFF: Cancel or reset 1: Hourly 2: Daily 3: Weekly 4: Monthly	Y	Y	4	
K81	Date Format	0: Y/M/D (year/month/day) 1: D/M/Y (day/month/year) 2: M/D/Y (month/day/year) 3: MD, Y (Month day, year)	Y	Y	2	6-294
K82	Time Format	0: 24-hour format (Time : Minute : Second) 1: 12-hour format (Time : Minute : Second AM/PM) 2: 12-hour format (AM/PM Time : Minute : Second)	Y	Y	0	
K83	Daylight Saving Time (Summer time)	0: Disable 1: Enable (+ 1 hour) 2: Enable (+ 30 minutes)	Y	Y	0	
K84	(Start date)	Possible to specify in the special menu.	Y	Y	0800H	6-295
K85	(End date)		Y	Y	0800H	
K91	Shortcut Key Function for  in Running Mode (Selection screen)	0: OFF (Disable) 11 to 99	Y	Y	OFF	6-296
K92	Shortcut Key Function for  in Running Mode (Selection screen)	0: OFF (Disable) 11 to 99	Y	Y	64	

o codes: Option Functions

Code	Name	Data setting range	Change when running	Data copying	Default setting	Related page
o01	Terminal [Y6A/B/C] Function (Relay output)	Same as E20.	N	Y	10	-
o02	Terminal [Y7A/B/C] Function		N	Y	6	
o03	Terminal [Y8A/B/C] Function		N	Y	25	
o04	Terminal [Y9A/B/C] Function		N	Y	26	
o05	Terminal [Y10A/B/C] Function		N	Y	28	
o06	Terminal [Y11A/B/C] Function		N	Y	36	
o07	Terminal [Y12A/B/C] Function		N	Y	37	
o09	Pt Channel (Display unit)	<u>Temperature</u> 60: K 61: °C 62: °F	Y	Y	61	
o10	Pt Channel 1 (Sensor type)	0: Jpt100 1: Pt100 2: Ni100 3: Pt1000 4: Ni1000	Y	Y	0	
o11	(Extended functions)	0: No extended function assigned 5: PID feedback value 1 30: PID feedback value 2 42: External PID feedback value 1 45: External PID feedback value 2 48: External PID feedback value 3	N	Y	0	
o12	(Filter)	0.0 to 100.0 s	Y	Y	1.0	
o15	Pt Channel 2 (Sensor type)	Same as o10.	N	Y	0	
o16	(Extended functions)	Same as o11.	N	Y	0	
o17	(Filter)	Same as o12.	Y	Y	1.0	
o27	Communications Error Processing	0: Immediately trip with alarm Er5 1: Run for the period specified by timer o28 and then trip with alarm Er5 2: Retry during the period specified by timer o28. If the retry fails, immediately trip with alarm Er5. 3: Continue to run. After recovery from the error, run according to communications command 4 to 9: Same as o27 = 0. 10: Decelerate to a stop and trip with alarm Er5 11: Run for the period specified by timer o28, decelerate to a stop, and then trip with alarm Er5 12: Retry during the period specified by timer o28. If the retry fails, decelerate to a stop. If it succeeds, continue to run according to communications command 13 to 15: Same as when o27 = 3.	Y	Y	0	
o28	(Timer)	0.0 to 60.0 s	Y	Y	0.0	
o30	Bus configuration parameter 01	0 to 255 Functions of o30 to o39 differ depending upon the bus option type. For details, refer to the instruction manual of each bus option.	N	Y	0	
o31	Bus configuration parameter 02	Same as o30.	N	Y	0	
o32	Bus configuration parameter 03		N	Y	0	
o33	Bus configuration parameter 04		N	Y	0	
o34	Bus configuration parameter 05		N	Y	0	
o35	Bus configuration parameter 06		N	Y	0	
o36	Bus configuration parameter 07		N	Y	0	
o37	Bus configuration parameter 08		N	Y	0	
o38	Bus configuration parameter 09		N	Y	0	
o39	Bus configuration parameter 10		N	Y	0	
o40	Function Code Assignment 1 for Write		0, 1 to 65535 0: No assignment Data mapped I/O (write) Whether or not to support the I/O or the number of supports differs depending upon the bus option type. For the data configuration procedure, refer to the instruction manual of each bus option.	N	Y	0

Code	Name	Data setting range	Change when running	Data copying	Default setting	Related page
o41	Function Code Assignment 2 for Write	Same as o40.	N	Y	0	-
o42	Function Code Assignment 3 for Write		N	Y	0	
o43	Function Code Assignment 4 for Write		N	Y	0	
o44	Function Code Assignment 5 for Write		N	Y	0	
o45	Function Code Assignment 6 for Write		N	Y	0	
o46	Function Code Assignment 7 for Write		N	Y	0	
o47	Function Code Assignment 8 for Write		N	Y	0	
o48	Function Code Assignment 1 for Read	0, 1 to 65535 0: No assignment Data mapped I/O (read) Whether or not to support the I/O or the number of supports differs depending upon the bus option type. For the data configuration procedure, refer to the instruction manual of each bus option.	N	Y	0	
o49	Function Code Assignment 2 for Read	Same as o48.	N	Y	0	
o50	Function Code Assignment 3 for Read		N	Y	0	
o51	Function Code Assignment 4 for Read		N	Y	0	
o52	Function Code Assignment 5 for Read		N	Y	0	
o53	Function Code Assignment 6 for Read		N	Y	0	
o54	Function Code Assignment 7 for Read		N	Y	0	
o55	Function Code Assignment 8 for Read		N	Y	0	
o56	Function Code Assignment 9 for Read		N	Y	0	
o57	Function Code Assignment 10 for Read		N	Y	0	
o58	Function Code Assignment 11 for Read		N	Y	0	
o59	Function Code Assignment 12 for Read		N	Y	0	
o60	Terminal [32] (Function)		Same as E61.	N	Y	0
o61	(Offset)	-5.0 to 5.0%	Y	Y	0.0	
o62	(Gain)	0.00 to 200.00%	Y	Y	100.00	
o63	(Filter setting)	0.00 to 5.00 s	Y	Y	0.05	
o64	(Gain base point)	0.00 to 100.00%	Y	Y	100.00	
o65	(Polarity)	0: Bipolar 1: Unipolar	N	Y	1	
o66	(Bias value)	-100.00 to 100.00%	Y	Y	0.00	
o67	(Bias base point)	0.00 to 100.00%	Y	Y	0.00	
o69	(Display unit)	Same as J105. (Note that the data setting range starts with "1.")	N	Y	2	
o70	(Maximum scale)	-999 to 0.00 to 9990	N	Y	100	
o71	(Minimum scale)	-999 to 0.00 to 9990	N	Y	0.00	
o75	Terminal [C2] (Current range)	0: 4-20 mA 1: 0-20 mA	N	Y	0	
o76	(Function)	Same as E61.	N	Y	0	
o77	(Offset)	-5.0 to 5.0%	Y	Y	0.0	
o78	(Gain)	0.00 to 200.00%	Y	Y	100.00	
o79	(Filter time constant)	0.00 to 5.00 s	Y	Y	0.05	
o81	(Gain reference point)	0.00 to 100.00%	Y	Y	100.00	
o82	(Bias value)	-100.00 to 100.00%	Y	Y	0.00	
o83	(Bias base point)	0.00 to 100.00%	Y	Y	0.00	
o85	(Display unit)	Same as J105. (Note that the data setting range starts with "1.")	N	Y	2	
o86	(Maximum scale)	-999 to 0.00 to 9990	N	Y	100	
o87	(Minimum scale)	-999 to 0.00 to 9990	N	Y	0.00	
o90	Terminal [Ao/CS2] Function (Function)	Same as F31.	Y	Y	0	
o91	(Output gain)	0 to 300%	Y	Y	100	
o93	(Polarity)	0: Bipolar 1: Unipolar	N	Y	1	
o96	Terminal [CS/CS1] Function (Function)	Same as F31.	Y	Y	0	
o97	(Output gain)	0 to 300 %	Y	Y	100	

Table A Factory Defaults Depending upon Inverter Capacity

Inverter capacity		Auto-restart after momentary power failure (Restart time) H13 [s]
[kW]	[HP]	
0.75	1	0.5
1.5	2	
2.2	3	
3.7	5	
5.5	7.5	
7.5	10	
11	15	1.0
15	20	
18.5	25	
22	30	
30	40	
37	50	
45	60	1.5
55	75	
75	100	
90	125	
110	150	
132	200	
160	250	2.0
200	300	
220	350	
280	450	2.5
315	-	
355	500	
400	600	4.0
500	800	
630	900	
710	1000	
		5.0

Table B Motor Parameter Factory Defaults

230 V class series

Destined for America (Base frequency 60 Hz, Rated voltage 230 V) (P99=1, HP rating)

Inverter type	Nominal applied motor (HP) P02	Rated current (A) P03	No-load current (A) P06	%R1 (%) P07	%X (%) P08	Rated slip frequency (Hz) P12	Starting mode (Auto search delay time 2) H46
FRN001AR1■-2U	1.00	3.00	1.54	3.96	8.86	2.50	0.5
FRN002AR1■-2U	2.00	5.80	2.80	4.29	7.74	2.50	
FRN003AR1■-2U	3.00	7.90	3.57	3.15	20.81	1.17	0.6
FRN005AR1■-2U	5.00	12.60	4.78	3.34	23.57	1.50	0.8
FRN007AR1■-2U	7.50	18.60	6.23	2.65	28.91	1.17	1.0
FRN010AR1■-2U	10.00	25.30	8.75	2.43	30.78	1.17	1.2
FRN015AR1■-2U	15.00	37.30	12.70	2.07	29.13	1.00	1.3
FRN020AR1■-2U	20.00	49.10	9.20	2.09	29.53	1.00	2.0
FRN025AR1■-2U	25.00	60.00	16.70	1.75	31.49	1.00	
FRN030AR1■-2U	30.00	72.40	19.80	1.90	32.55	1.00	
FRN040AR1■-2U	40.00	91.00	13.60	1.82	25.32	0.47	2.3
FRN050AR1■-2U	50.00	115.0	18.70	1.92	24.87	0.58	2.5
FRN060AR1■-2U	60.00	137.0	20.80	1.29	26.99	0.35	
FRN075AR1S-2U	75.00	174.0	28.60	1.37	27.09	0.35	2.6
FRN100AR1S-2U	100.0	226.0	37.40	1.08	23.80	0.23	2.8
FRN125AR1S-2U	125.0	268.0	29.80	1.05	22.90	0.35	3.2

Note: The box (■) replaces an alphabetic letter depending on the enclosure: M (NEMA/UL TYPE 1) or L (NEMA/UL TYPE 12).

Table B Motor Parameter Factory Defaults (continued)

460 V class series

Destined for America (Base frequency 60 Hz, Rated voltage 460 V) (P99 = 1, HP rating)

Inverter type	Nominal applied motor (HP) P02	Rated current (A) P03	No-load current (A) P06	%R1 (%) P07	%X (%) P08	Rated slip frequency (Hz) P12	Starting mode (Auto search delay time 2) H46
FRN001AR1■-4U	1.00	1.50	0.77	3.96	8.86	2.50	0.5
FRN002AR1■-4U	2.00	2.90	1.40	4.29	7.74	2.50	
FRN003AR1■-4U	3.00	4.00	1.79	3.15	20.81	1.17	0.6
FRN005AR1■-4U	5.00	6.30	2.39	3.34	23.57	1.50	0.8
FRN007AR1■-4U	7.50	9.30	3.12	2.65	28.91	1.17	1.0
FRN010AR1■-4U	10.00	12.70	4.37	2.43	30.78	1.17	1.2
FRN015AR1■-4U	15.00	18.70	6.36	2.07	29.13	1.00	1.3
FRN020AR1■-4U	20.00	24.60	4.60	2.09	29.53	1.00	2.0
FRN025AR1■-4U	25.00	30.00	8.33	1.75	31.49	1.00	
FRN030AR1■-4U	30.00	36.20	9.88	1.90	32.55	1.00	
FRN040AR1■-4U	40.00	45.50	6.80	1.82	25.32	0.47	2.3
FRN050AR1■-4U	50.00	57.50	9.33	1.92	24.87	0.58	2.5
FRN060AR1■-4U	60.00	68.70	10.40	1.29	26.99	0.35	2.5
FRN075AR1■-4U	75.00	86.90	14.30	1.37	27.09	0.35	2.6
FRN100AR1■-4U	100.0	113.0	18.70	1.08	23.80	0.23	2.8
FRN125AR1■-4U	125.0	134.0	14.90	1.05	22.90	0.35	3.2
FRN150AR1S-4U	150.0	169.0	45.20	0.96	21.61	0.39	3.5
FRN200AR1S-4U	200.0	231.0	81.80	0.72	20.84	0.23	4.1
FRN250AR1S-4U	250.0	272.0	41.10	0.71	18.72	0.35	4.5
FRN300AR1S-4U	300.0	323.0	45.10	0.53	18.44	0.23	4.7
FRN350AR1S-4U	350.0	375.0	68.30	0.99	19.24	0.46	
FRN450AR1S-4U	450.0	481.0	85.50	0.95	19.01	0.48	5.5
FRN500AR1S-4U	500.0	534.0	99.20	1.05	18.39	0.45	5.6
FRN600AR1S-4U	600.0	638.0	140.0	0.85	18.38	0.39	
FRN800AR1S-4U	800.0	870.0	209.0	1.17	21.69	0.45	7.5
FRN900AR1S-4U	900.0	923.0	172.0	1.34	25.44	0.60	9.8
FRN1000AR1S-4U	1000	994.0	239.0	1.40	23.79	0.55	10.5

Note: The box (■) replaces an alphabetic letter depending on the enclosure: M (NEMA/UL TYPE 1) or L (NEMA/UL TYPE 12).

Table B Motor Parameter Factory Defaults (continued)

575 V class series

Destined for America (Base frequency 60 Hz, Rated voltage 575 V) (P99 = 1, HP rating)

Inverter type	Nominal applied motor (HP) P02	Rated current (A) P03	No-load current (A) P06	%R1 (%) P07	%X (%) P08	Rated slip frequency (Hz) P12	Starting mode (Auto search delay time 2) H46
FRN001AR1■-5U	1.00	1.20	0.70	3.96	8.86	2.50	0.5
FRN002AR1■-5U	2.00	2.40	1.40	4.29	7.74	2.50	0.5
FRN003AR1■-5U	3.00	3.20	1.50	3.15	20.81	1.17	0.6
FRN005AR1■-5U	5.00	5.00	2.20	3.34	23.57	1.50	0.8
FRN007AR1■-5U	7.50	7.70	3.60	2.65	28.91	1.17	1.0
FRN010AR1■-5U	10.00	10.00	4.00	2.43	30.78	1.17	1.2
FRN015AR1■-5U	15.00	15.00	6.20	2.07	29.13	1.00	1.3
FRN020AR1■-5U	20.00	19.30	6.80	2.09	29.53	1.00	2.0
FRN025AR1■-5U	25.00	24.80	10.40	1.75	31.49	1.00	2.0
FRN030AR1■-5U	30.00	29.20	12.00	1.90	32.55	1.00	2.0
FRN040AR1■-5U	40.00	38.00	14.00	1.82	25.32	0.47	2.3
FRN050AR1■-5U	50.00	49.20	20.60	1.92	24.87	0.58	2.5
FRN060AR1■-5U	60.00	56.00	19.20	1.29	26.99	0.35	2.5
FRN075AR1■-5U	75.00	69.00	22.40	1.37	27.09	0.35	2.6
FRN100AR1■-5U	100.0	90.50	22.40	1.08	23.80	0.23	2.8
FRN125AR1■-5U	125.0	113.0	30.40	1.05	22.90	0.35	3.2
FRN150AR1■-5U	150.0	138.0	48.00	0.96	21.61	0.39	3.5
FRN200AR1S-5U	200.0	228.0	69.60	0.71	18.72	0.35	4.5
FRN250AR1S-5U	250.0	271.0	78.40	0.53	18.44	0.23	4.7
FRN300AR1S-5U	300.0	316.0	92.00	0.99	19.24	0.46	4.7

Note: The box (■) replaces an alphabetic letter depending on the enclosure: M (NEMA/UL TYPE 1) or L (NEMA/UL TYPE 12).

6.3 Details of Function Codes

This section provides the details of the function codes. The descriptions are, in principle, arranged in the order of function code groups and in numerical order. However, highly relevant function codes are collectively described where one of them first appears.

6.3.1 F codes (Fundamental functions)

F00	Data Protection
-----	-----------------

F00 specifies whether to protect function code data (except F00) and digital reference data (such as frequency command and PID command) from accidentally getting changed by pressing the \curvearrowright / \curvearrowleft / \curvearrowright / \curvearrowleft keys on the keypad.

Data for F00	Changing function code data		Changing digital reference data with the \curvearrowright / \curvearrowleft / \curvearrowright / \curvearrowleft keys
	From the keypad	Via communications link	
0	Allowed	Allowed	Allowed
1	Not allowed *	Allowed	Allowed
2	Allowed	Allowed	Not allowed
3	Not allowed *	Allowed	Not allowed

*Only F00 data can be modified with the keypad, while all other function codes cannot.

To change F00 data, simultaneous keying of $\text{STOP} + \curvearrowright$ (from 0 to 1) or $\text{STOP} + \curvearrowleft$ (from 1 to 0) keys is required.

For similar purposes, **WE-KP**, a signal enabling editing of function code data from the keypad is provided as a terminal command for digital input terminals. (Refer to the descriptions of E01 through E07. data = 19)









The relationship between the terminal command **WE-KP** and F00 data are as shown below.

WE-KP	Changing function code data	
	From the keypad	Via communications link
OFF	Not allowed	Follow the F00 setting
ON	Follow the F00 setting	

- Note**
- If you mistakenly assign a **WE-KP** to any digital input terminal, you can no longer edit or modify function code data. In such a case, temporarily turn this **WE-KP**-assigned terminal ON and reassign the **WE-KP** to a correct command.
 - **WE-KP** is only a signal that allows you to change function code data, so it does not protect the frequency settings or PID command specified by the \curvearrowright / \curvearrowleft / \curvearrowright / \curvearrowleft keys.









F01	Frequency Command 1 F18 (Bias, Frequency command 1) C30 (Frequency Command 2) C31 to C35 (Analog Input Adjustment for [12]) C36 to C39 (Analog Input Adjustment for [C1]) C41 to C45 (Analog Input Adjustment for [V2]) C50 (Bias (Frequency command 1), Bias base point) H61 (UP/DOWN Control, Initial frequency setting) C21 to C28 (Pattern operation)
------------	--



F01 or C30 sets the command source that specifies reference frequency 1 or reference frequency 2, respectively.

Data for F01, C30	Function
0	Enable  /  /  /  keys on the keypad. (Refer to the procedure given below.)
1	Enable the voltage input to terminal [12] (0 to ±10 VDC, maximum frequency obtained at ±10 VDC).
2	Enable the current input to terminal [C1] (+4 to +20 mA DC or 0 to +20 mA DC, maximum frequency obtained at +20 mA DC).
3	Enable the sum of voltage (0 to ±10 VDC) and current inputs (+4 to +20 mA DC or 0 to +20 mA DC) given to terminals [12] and [C1], respectively. See the two items listed above for the setting range and the value required for maximum frequencies. Note: If the sum exceeds the maximum frequency (F03), the maximum frequency will apply.
5	Enable the voltage input to terminal [V2] (0 to ±10 VDC, maximum frequency obtained at ±10 VDC). (SW5 on the control circuit board should be turned to the V2 position (factory default).)
7	Enable UP and DOWN commands assigned to digital input terminals. The UP and DOWN should be assigned to any of digital input terminals [X1] to [X7] beforehand with any of E01 to E07 (data = 17, 18).
8	Enable  /  /  /  keys on the keypad (balanceless-bumpless switching available).
10	Enable a pattern operation in which the inverter automatically runs the motor according to the preset running period, rotation direction, acceleration/ deceleration time, and reference frequency. For details, refer to the description of C21 to C28.

Setting up a reference frequency

[1] Using the keypad (F01 = 0 (factory default) or 8)

- (1) Set F01 data to "0" or "8." This can be done only when the inverter is in Running mode.
- (2) Press the  /  /  /  key to display the current reference frequency. The lowest digit on the LCD monitor will blink.
- (3) To change the reference frequency, press the  /  /  /  key again. To save the new setting into the inverter's memory, press the  key (when E64 = 1 (factory default)). When the power is turned ON next time, the new setting will be used as an initial reference frequency.

 • In addition to the saving with the  key described above, auto-saving is also available (when E64 = 0).



- When you start accessing the reference frequency or any other parameter with the \uparrow / \downarrow / \leftarrow / \rightarrow key, the least significant digit on the display blinks, indicating that the cursor lies in the least significant digit. Holding down the \uparrow / \downarrow / \leftarrow / \rightarrow key changes data in the least significant digit and generates a carry, while the cursor remains in the least significant digit.
- While the least significant digit is blinking by pressing the \uparrow / \downarrow / \leftarrow / \rightarrow key once, pressing the \leftarrow / \rightarrow key moves the cursor. This cursor movement allows you to easily move the cursor to the desired digit and change the data in higher digits.
- Setting F01 data to "8" enables the balanceless-bumpless switching. When the frequency command source is switched to the keypad from any other source, the inverter inherits the current frequency that has applied before switching, providing smooth switching and shockless running.

[2] Using analog input (F01 = 1 to 3, or 5)

When any analog input (voltage input to terminals [12] and [V2], or current input to terminal [C1]) is selected by F01 (Frequency Command 1) or C30 (Frequency Command 2), it is possible to arbitrarily specify the reference frequency by multiplying the gain and adding the bias. The polarity can be selected and the filter time constant and offset can be adjusted.

Adjustable elements of frequency command 1 (F01)

Data for F01	Input terminal	Input range	Bias		Gain		Polarity	Filter time constant	Offset	Input range selection
			Bias	Base point	Gain	Base point				
1	[12]	0 to +10 V, -10 to +10V	F18	C50	C32	C34	C35	C33	C31	-
2	[C1]	4 to 20 mA 0 to 20 mA	F18	C50	C37	C39	-	C38	C36	C40
3	[12] + [C1] (Sum of the two values)	0 to +10 V, -10 to +10 V	F18	C50	C32	C34	C35	C33	C31	-
		4 to 20 mA 0 to 20 mA	F18	C50	C37	C39	-	C38	C36	C40
5	[V2]	0 to +10 V, -10 to +10 V	F18	C50	C42	C44	C45	C43	C41	-

Adjustable elements of frequency command 2 (C30)

Data for C30	Input terminal	Input range	Bias		Gain		Polarity	Filter time constant	Offset	Input range selection
			Bias	Base point	Gain	Base point				
1	[12]	0 to +10 V, -10 to +10V	C55	C56	C32	C34	C35	C33	C31	-
2	[C1]	4 to 20 mA 0 to 20 mA	C61	C62	C37	C39	-	C38	C36	C40
3	[12] + [C1] (Sum of the two values)	0 to +10 V, -10 to +10 V	C55	C56	C32	C34	C35	C33	C31	-
		4 to 20 mA 0 to 20 mA	C61	C62	C37	C39	-	C38	C36	C40
5	[V2]	0 to +10 V, -10 to +10 V	C67	C68	C42	C44	C45	C43	C41	-

Switching between frequency command 1 (F01) and 2 (C30)

Frequency command 1 (F01) and 2 (C30) can be switched by the external input signal ***H_{z2}/H_{z1}*** ("Select frequency command 2/1") assigned to any digital input terminal.

 For details about ***H_{z2}/H_{z1}***, refer to the description of E01 through E07 (data = 11).

Digital input signal <i>H_{z2}/H_{z1}</i>	Frequency command source
OFF	Frequency command 1 (F01)
ON	Frequency command 2 (C30)

■ Offset (C31, C36, C41)

C31, C36 or C41 specifies an offset for analog input voltage or current. The offset also applies to signals sent from the external equipment.

■ Filter time constant (C33, C38, C43)

C33, C38, or C43 specifies a filter time constant for analog input voltage or current. Choose an appropriate value for the time constant taking into account the response speed of the machinery system since a large time constant slows down the response. When the input voltage fluctuates due to noise, specify a larger time constant.

■ Polarity (C35, C45)

C35 or C45 specifies the input range for analog input voltage.

Data for C35/C45	Terminal input specifications
0	-10 to +10 VDC
1	0 to +10 VDC (negative value of voltage is regarded as 0 V)

■ Terminal [C1] Input Range Selection (C40)

C40 specifies the input range of terminal [C1] (analog input current).

Data for C40	Terminal [C1] input range
0	4 to 20 mA (factory default)
1	0 to 20 mA

■ Gain and bias

Input terminal	Frequency command 1 (F01)	Frequency command 2 (C30)
[12]		
[C1]		
[V12]		

Note If F01 = 3 (the sum of [12] + [C1] is enabled), the bias and gain are independently applied to each of the voltage and current inputs given to terminals [12] and [C1], and the sum of the two values is applied as the reference frequency.

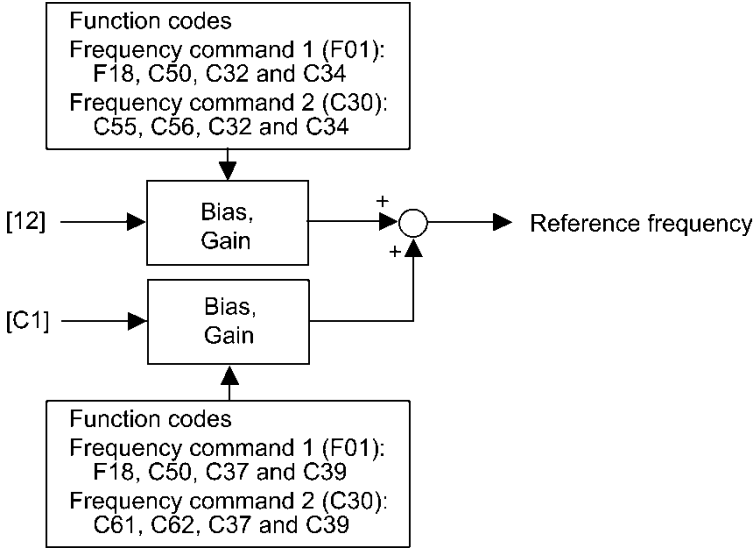

In the case of unipolar input

(terminal [12] with C35 = 1, terminal [C1], terminal [V2] with C45 = 1)

As shown in the graphs above, the relationship between the analog input and the reference frequency specified by **frequency command 1 (F01)** is determined by points "A" and "B." Point "A" is defined by the combination of the bias (F18) and its base point (C50); Point "B," by the combination of the gain and its base point (C32 and C34, C37 and C39, or C42 and C44).

The relationship between the analog input and the reference frequency specified by **frequency command 2 (C30)** is determined by points "A" and "B." Point "A" is defined by the combination of the bias and its base point (C55 and C56, C61 and C62, or C67 and C68), Point "B," by the combination of the gain and its base point (C32 and C34, C37 and C39, or C42 and C44).

The combination of C32 and C34 applies to terminal [12], that of C37 and C39, to [C1], and that of C42 and C44, to [V2].

Configure the bias and its gain, assuming the maximum frequency as 100%, and the bias base point and gain base point, assuming the full scale (10 VDC or 20 mA DC) of analog input as 100%.



Frequency command 1 (F01)

- The analog input less than the bias base point (C50) is limited by the bias value (F18).
- Specifying that the data of the bias base point (C50) is equal to or greater than that of each gain base point (C34, C39 or C44) will be interpreted as invalid, so the inverter will reset the reference frequency to 0 Hz.

Frequency command 2 (C30)

- The analog input less than the bias base point (C56, C62 or C68) is limited by the bias value (C55, C61 or C67).
- Specifying that the data of the bias base point (C56, C62 or C68) is equal to or greater than that of each gain base point (C34, C39 or C44) will be interpreted as invalid, so the inverter will reset the reference frequency to 0 Hz.

Example: Setting the bias, gain, and their base points when the reference frequency 0 to 60 Hz follows the analog input of 1 to 5 VDC applied on terminal [12] with the maximum frequency 60 Hz (F03)

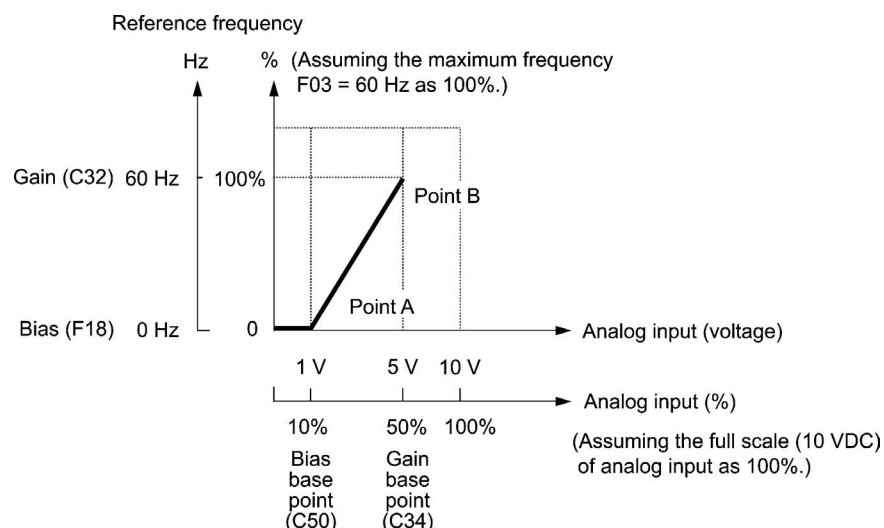

(Point A)

Frequency command 1 (F01)

To set the reference frequency to 0 Hz for an analog input being at 1 V, set the bias to 0% (F18 = 0). Since 1 V is the bias base point and it is equal to 10% of 10 V (full scale of terminal [12]), set the bias base point to 10% (C50 = 10).

Frequency command 2 (C30)

Just as frequency command 1, set the bias to 0% (C55 = 0) and the bias base point, to 10% (C56 = 10).

(Point B)

Frequency command 1 (F01), Frequency command 2 (C30)

To specify the maximum frequency equal to the reference frequency for an analog input being at 5 V, set the gain to 100% (C32 = 100). Since 5 V is the gain base point and it is equal to 50% of 10 V (full scale of terminal [12]), set the gain base point to 50% (C34 = 50).

Note The setting procedure for specifying a gain or bias alone without changing any base points is the same as that of Fuji conventional inverters of FRENIC5000G11S/P11S series, FVR-E11S series, etc.

**In the case of bipolar input
(terminal [12] with C35 = 0, terminal [V2] with C45 = 0)**

Setting C35 and C45 data to "0" enables terminals [12] and [V2] to be used for bipolar input (-10 V to +10 V), respectively.

When both the bias (F18, C55 or C67) and its base point (C50, C56 or C68) are set to "0," the negative and positive voltage inputs produce reference frequencies symmetric about the origin point as shown below.

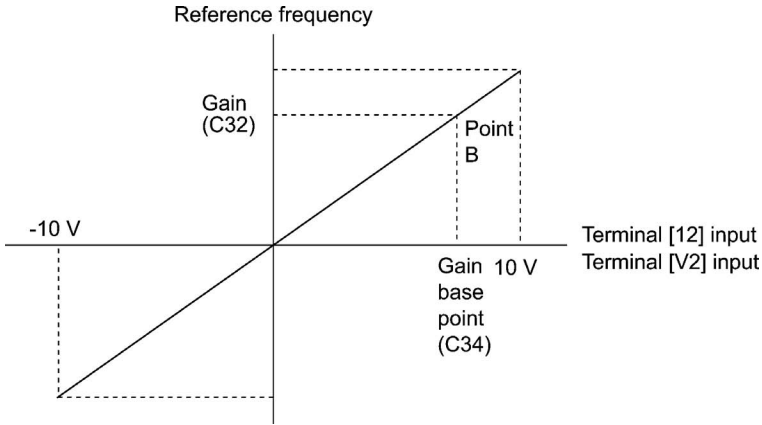

Note • Configuring the bias (F18, C55 or C67) and its base point (C50, C56 or C68) to specify an arbitrary value (Points A1, A2, and A3) gives the bias as shown below.

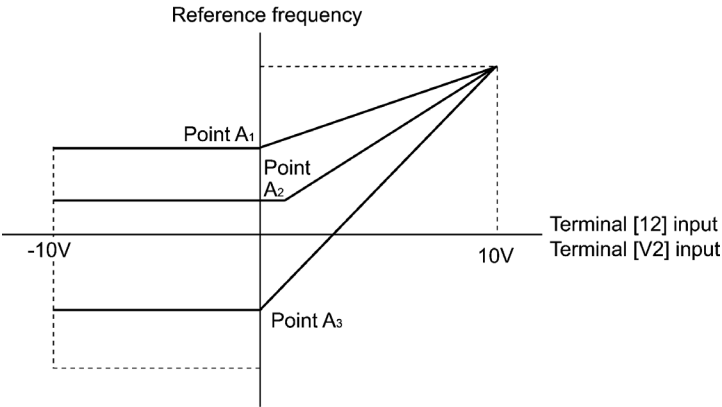

Note

- To input bipolar analog voltage (0 to ±10 VDC) to terminals [12] and [V2], set C35 and C45 data to "0." Setting C35 and C45 data to "1" enables the voltage range from 0 to +10 VDC and interprets the negative polarity input from 0 to -10 VDC as 0 V.
- A reference frequency can be specified not only with the frequency (Hz) but also with other menu items, depending on the setting of function code E48 (= 3 to 5, or 7).

[3] Using digital input signals *UP/DOWN* (F01 = 7)

When *UP/DOWN* control is selected for frequency setting, turning the terminal command *UP* or *DOWN* ON causes the output frequency to increase or decrease, respectively, within the range from 0 Hz to the maximum frequency as listed below.

To enable *UP/DOWN* control for frequency setting, it is necessary to set F01 data to "7" and assign the *UP* and *DOWN* commands to any of digital input terminals [X1] to [X7], [FWD] and [REV] with any of E01 to E07 (data = 17, 18).

<i>UP</i>	<i>DOWN</i>	Function
Data = 17	Data = 18	
OFF	OFF	Keep the current output frequency.
ON	OFF	Increase the output frequency with the acceleration time currently specified.
OFF	ON	Decrease the output frequency with the deceleration time currently specified.
ON	ON	Keep the current output frequency.

F02	Operation Method
------------	-------------------------

F02 selects the source that specifies a run command. The table below lists the run command sources and the rotational directions of the motor.

Data for F02		Description
0	Keypad	Enable the FWD / REV / STOP keys to run and stop the motor.
1	External signals (Digital input terminal commands)	Enable terminal command FWD and REV to run and stop the motor.
2	Keypad (Forward rotation)	Enable FWD / STOP keys to run and stop the motor. Note that this run command enables only the forward rotation. There is no need to specify the rotational direction.
3	Keypad (Reverse rotation)	Enable REV / STOP keys to run and stop the motor. Note that this run command enables only the reverse rotation. There is no need to specify the rotational direction.

Terminal commands **FWD** ("Run forward") and **REV** ("Run reverse") must be assigned to terminals [FWD] and [REV], respectively.

For details about **FWD** and **REV**, refer to E98 and E99 (data = 98 or 99).

- Note**
- When the **FWD** or **REV** is ON, the F02 data cannot be changed.
 - When changing terminal command assignments to terminals [FWD] and [REV] from commands other than the **FWD** and **REV** to the **FWD** or **REV** with F02 being set to "1," be sure to turn the target terminal OFF beforehand; otherwise, the motor may unintentionally rotate.

■ 3-wire operation with external input signals (digital input terminal commands)

The default setting of the **FWD** and **REV** are 2-wire. Assigning the terminal command **HLD** self-holds the forward **FWD** or reverse **REV** run command, to enable 3-wire inverter operation.

For details about **HLD**, refer to E01 to E07 (data = 6).

Short-circuiting the **HLD**-assigned terminal and [CM] (i.e., when **HLD** is ON) self-holds the first **FWD** or **REV** at its rising edge. Turning the **HLD** OFF releases the self-holding. When no **HLD** is assigned, 2-wire operation involving only **FWD** and **REV** takes effect.

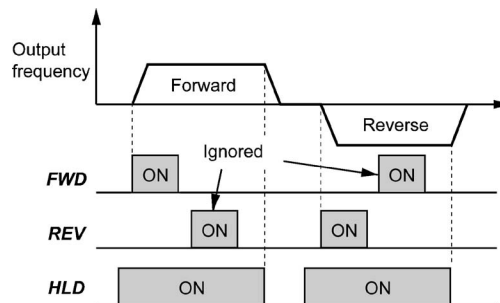

In addition to the run command sources described above, higher priority command sources including remote and local modes (see Chapter 5 Section 5.5.4) and communications link are provided

F03**Maximum Frequency 1**

F03 specifies the maximum frequency to limit the output frequency. Specifying the maximum frequency exceeding the rating of the equipment driven by the inverter may cause damage or a dangerous situation. Make sure that the maximum frequency setting matches the equipment rating.

- Data setting range: 25.0 to 120.0 (Hz)

⚠ WARNING

The inverter can easily accept high-speed operation settings. When changing the speed setting, carefully check the specifications of motors or equipment beforehand.

Otherwise injuries could occur.

Note Modifying F03 data to allow a higher output frequency requires also changing F15 data specifying a frequency limiter (high).

**F04, F05
F06****Base Frequency 1, Rated Voltage at Base Frequency 1, Maximum Output Voltage 1**

**H50, H51 (Non-linear V/f Pattern 1, Frequency and Voltage)
H52, H53 (Non-linear V/f Pattern 2, Frequency and Voltage)**

These function codes specify the base frequency and the voltage at the base frequency essentially required for running the motor properly. If combined with the related function codes H50 through H53, these function codes may profile the non-linear V/f pattern suitable for the load by specifying increase or decrease in voltage at any point on the V/f pattern.

The following descriptions include setups required for the non-linear V/f patterns.

At high frequencies, the motor impedance may increase, resulting in an insufficient output voltage and a decrease in output torque. To prevent this problem, use F06 (Maximum Output Voltage 1) to increase the voltage. Note, however, that the inverter cannot output voltage exceeding its input power voltage.

V/f point	Function code		Remarks
	Frequency	Voltage	
Maximum frequency	F03	F06	The setting of the maximum output voltage is disabled when the auto torque boost or torque vector control is selected.
Base frequency	F04	F05	
Non-linear V/f pattern 2	H52	H53	Disabled when the auto torque boost or torque vector control is selected.
Non-linear V/f pattern 1	H50	H51	

■ Normal (linear) V/f pattern

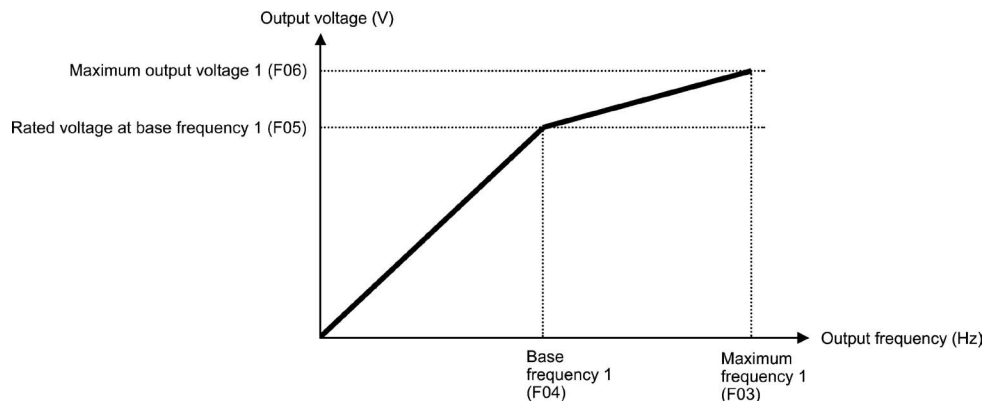

■ V/f pattern with three non-linear points

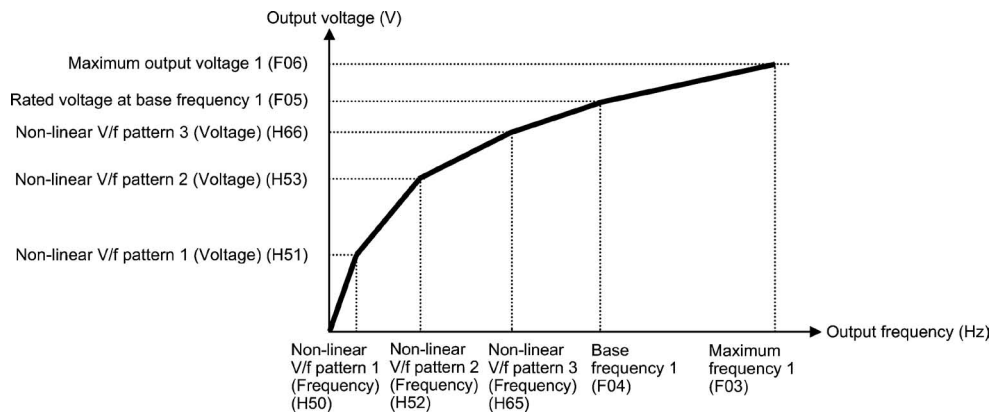

■ Base Frequency 1 (F04)

Set F04 data to the rated frequency printed on the nameplate labeled on the motor.

- Data setting range: 25.0 to 120.0 (Hz)

■ Rated Voltage at Base Frequency 1 (F05)

Set F05 data to "0" or the rated voltage printed on the nameplate labeled on the motor.

- Data setting range:

OFF : Disable the Automatic Voltage Regulator (AVR).
 80 to 240 (V) : Output an AVR-controlled voltage (230 V class series)
 160 to 500 (V) : Output an AVR-controlled voltage (460 V class series)
 200 to 600 (V) : Output an AVR-controlled voltage (575 V class series)

- If F05 = OFF, the rated voltage at base frequency is at the same level as the inverter input voltage. The output voltage will fluctuate in line with the input voltage fluctuation.
- If F05 = an arbitrary value other than "OFF," the inverter automatically keeps the output voltage constant in line with the setting. When any control function such as auto torque boost, auto energy saving, slip compensation, etc. is enabled, the F05 data should be equal to the rated voltage of the motor (printed on the nameplate of the motor).

Note The voltage the inverter can output is at the same level as the inverter input voltage. Configure these voltages correctly in accordance with the motor specifications.

■ Non-linear V/f Patterns 1 and 2 for Frequency (H50 and H52)

H50 or H52 specifies the frequency component at an arbitrary point in the non-linear V/f pattern.

- Data setting range: OFF (cancel)
0.1 to 120.0 (Hz)

Note Setting "OFF" to H50 or H52 disables the non-linear V/f pattern operation.

■ Non-linear V/f Patterns 1 and 2 for Voltage (H51 and H53)

H51 or H53 specifies the voltage component at an arbitrary point in the non-linear V/f pattern.

- Data setting range:

- 0 to 240 (V) : Output an AVR-controlled voltage (230 V class series)
- 0 to 500 (V) : Output an AVR-controlled voltage (460 V class series)
- 0 to 690 (V) : Output an AVR-controlled voltage (575 V class series)

Note The factory default values for H50 and H51 differ depending on the inverter capacity and destination. Refer to the following table.

Capacity	30 HP or below	40 HP or above	
H50	OFF	230 V class series 460 V class series 575 V class series	OFF OFF OFF
H51	0	230 V class series 460 V class series 575 V class series	20 0 0

■ Maximum Output Voltage 1 (F06)

F06 specifies the voltage for the maximum frequency 1 (F03).

- Data setting range:

- 80 to 240 (V) : Output an AVR-controlled voltage (230 V class series)
- 160 to 500 (V) : Output an AVR-controlled voltage (460 V class series)
- 200 to 600 (V) : Output an AVR-controlled voltage (575 V class series)

Note If F05 (Rated Voltage at Base Frequency 1) is set to "OFF," settings of H50 through H53 and F06 do not take effect. (When the non-linear point is below the base frequency, the linear V/f pattern applies; when it is above, the output voltage is kept constant.)

F07, F08	<p>Acceleration Time 1, Deceleration Time 1</p> <p>E10, E12, E14 (Acceleration Time 2, 3 and 4) E11, E13, E15 (Deceleration Time 2, 3 and 4) H07 (Acceleration/Deceleration Pattern) H56 (Deceleration Time for Forced Stop)</p>
----------	--

F07 specifies the acceleration time, the length of time the frequency increases from 0 Hz to the maximum frequency. F08 specifies the deceleration time, the length of time the frequency decreases from the maximum frequency down to 0 Hz.

- Data setting range: 0.00 to 3600.00 (s)

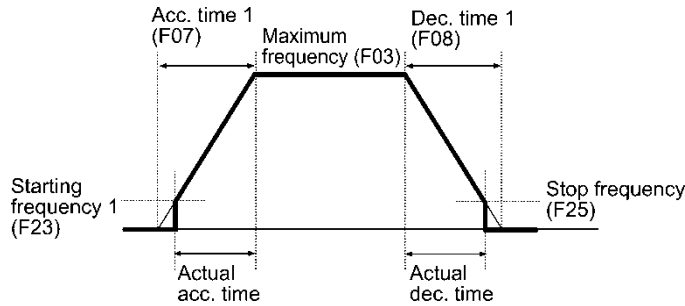

■ Acceleration/deceleration time

Acceleration/ deceleration time	Function code		Switching factor of acceleration/deceleration time (Refer to the descriptions of E01 to E07.)		
	ACC time	DEC time	<i>RT2</i>	<i>RT1</i>	
Acceleration/ deceleration time 1	F07	F08	OFF	OFF	The combinations of ON/OFF states of the two terminal commands <i>RT2</i> and <i>RT1</i> offer four choices of acceleration/deceleration time 1 to 4. (Data = 4, 5)
Acceleration/ deceleration time 2	E10	E11	OFF	ON	
Acceleration/ deceleration time 3	E12	E13	ON	OFF	If no terminal command is assigned, only the acceleration/deceleration time 1 (F07/F08) is effective.
Acceleration/ deceleration time 4	E14	E15	ON	ON	
Force to stop	-	H56	If terminal command <i>STOP</i> (data = 30) is turned OFF, the inverter decelerates to a stop with the deceleration time specified by H56. After that, the inverter displays alarm Er6 and enters an alarm state.		

■ Acceleration/Deceleration pattern (H07)

H07 specifies the acceleration and deceleration patterns (patterns to control output frequency).

Data for H07	Acceleration/ deceleration pattern	Motion		Function code
0	Linear	The inverter runs the motor with the constant acceleration and deceleration.		-
1	S-curve (Weak)	To reduce an impact that acceleration/deceleration would make on the machine, the inverter gradually accelerates or decelerates the motor in both the starting and ending zones of acceleration or deceleration.	Weak: The acceleration/deceleration rate to be applied to all of the four inflection zones is fixed at 5% of the maximum frequency.	-
			Strong: The acceleration/deceleration rate to be applied to all of the four inflection zones is fixed at 10% of the maximum frequency.	-
2	S-curve (Strong)			-
3	Curvilinear	Acceleration/deceleration is linear below the base frequency (constant torque) but it slows down above the base frequency to maintain a certain level of load factor (constant output). This acceleration/deceleration pattern allows the motor to accelerate or decelerate with the maximum performance of the motor.		-

S-curve acceleration/deceleration

To reduce an impact that acceleration/deceleration would make on the machine, the inverter gradually accelerates or decelerates the motor in both the starting and ending zones of acceleration or deceleration. Two types of S-curve acceleration/deceleration rates are available; applying 5% (weak) and 10% (strong) of the maximum frequency to all of the four inflection zones. The reference acceleration/deceleration time determines the duration of acceleration/deceleration in the linear period; hence, the actual acceleration/deceleration time is longer than the reference acceleration/deceleration time.

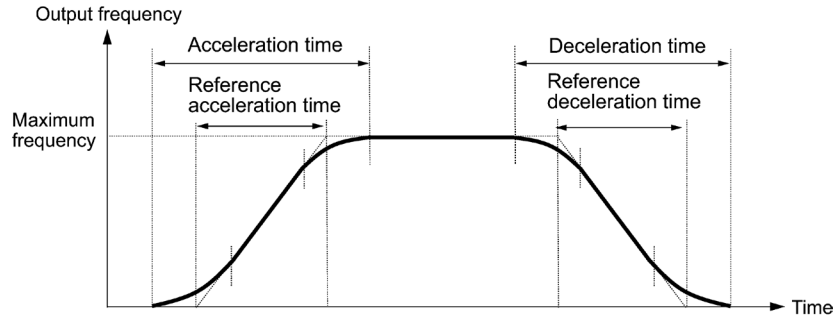

	Acceleration		Deceleration	
	Starting zone	Ending zone	Starting zone	Ending zone
S-curve (Weak)	5%	5%	5%	5%
S-curve (Strong)	10%	10%	10%	10%

<S-curve acceleration/deceleration (weak): when the frequency change is 10% or more of the maximum frequency>

$$\begin{aligned} \text{Acceleration or deceleration time (s)} &= (2 \times 5/100 + 90/100 + 2 \times 5/100) \times (\text{reference acceleration or deceleration time}) \\ &= 1.1 \times (\text{reference acceleration or deceleration time}) \end{aligned}$$

<S-curve acceleration/deceleration (strong): when the frequency change is 20% or more of the maximum frequency--10% at the leading edge and 20% at the trailing edge>

$$\begin{aligned} \text{Acceleration or deceleration time (s)} &= (2 \times 10/100 + 80/100 + 2 \times 10/100) \times (\text{reference acceleration or deceleration time}) \\ &= 1.2 \times (\text{reference acceleration or deceleration time}) \end{aligned}$$

Curvilinear acceleration/deceleration

Acceleration/deceleration is linear below the base frequency (constant torque) but it slows down above the base frequency to maintain a certain level of load factor (constant output).

This acceleration/deceleration pattern allows the motor to accelerate or decelerate with its maximum performance.

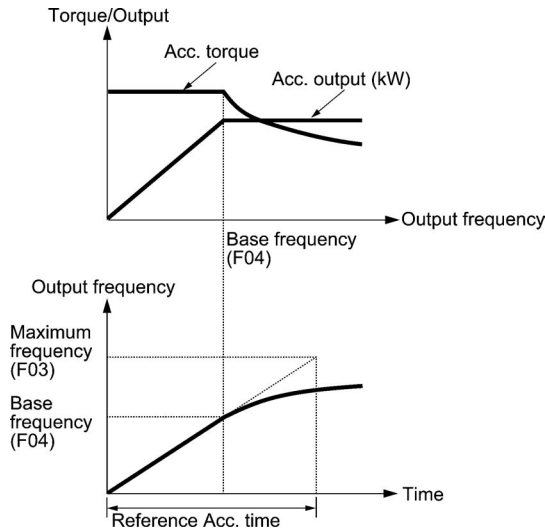

The figures at left show the acceleration characteristics. Similar characteristics apply to the deceleration.

- Note**
- If you choose S-curve acceleration/deceleration or curvilinear acceleration/deceleration in Acceleration/Deceleration Pattern (H07), the actual acceleration/deceleration times are longer than the specified ones.
 - Specifying an improperly short acceleration/deceleration time may activate the current limiter, torque limiter, or anti-regenerative control (automatic deceleration), resulting in a longer acceleration/deceleration time than the specified one.

F09	Torque Boost 1	(Refer to F37.)
------------	-----------------------	------------------------

Refer to the description of F37.

F10 to F12	Electronic Thermal Overload Protection for Motor 1 (Select motor characteristics, Overload detection level, Thermal time constant)
-------------------	---

F10 through F12 specify the thermal characteristics of the motor for its electronic thermal overload protection that is used to detect overload conditions of the motor inside the inverter.

F10 selects the motor cooling mechanism to specify its characteristics, F11 specifies the overload detection current, and F12 specifies the thermal time constant.

Upon detection of overload conditions of the motor, the inverter shuts down its output and issues a motor overload alarm **OL1** to protect motor 1.

- Note** Thermal characteristics of the motor specified by F10 and F12 are also used for the overload early warning. Even if you need only the overload early warning, set these characteristics data to these function codes. (Refer to the description of E34.) To disable the electronic thermal overload protection, set F11 data to "OFF."

- Note** For motors with PTC thermistor, connecting the PTC thermistor to the terminal [C1] enables the motor overheat protective function. For details, refer to the description of H26.

■ Select motor characteristics (F10)

F10 selects the cooling mechanism of the motor--shaft-driven or separately powered cooling fan.

Data for F10	Function
1	For a general-purpose motor with shaft-driven cooling fan (The cooling effect will decrease in low frequency operation.)
2	For an inverter-driven motor, non-ventilated motor, or motor with separately powered cooling fan (The cooling effect will be kept constant regardless of the output frequency.)

The figure below shows operating characteristics of the electronic thermal overload protection when F10 = 1. The characteristic factors $\alpha 1$ through $\alpha 3$ as well as their corresponding output frequencies $f 2$ and $f 3$ differ depending on the characteristics of the motor. The tables below list the factors of the motor selected by P99 (Motor 1 Selection).

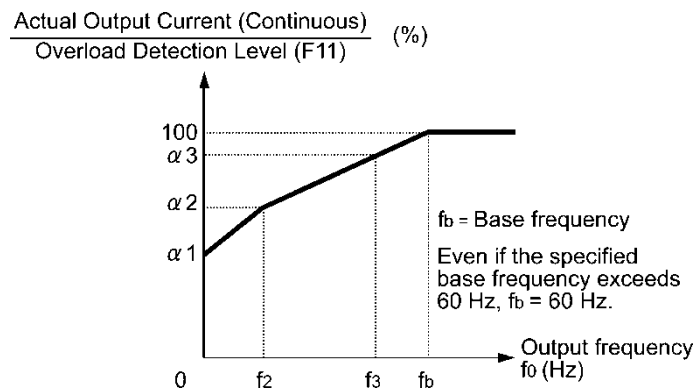

Nominal Applied Motor and Characteristic Factors when P99 (Motor 1 selection) = 0 or 4

Nominal applied motor (kW)	Thermal time constant τ (Factory default)	Reference current for setting the thermal time constant (I_{max})	Output frequency for motor characteristic factor		Characteristic factor (%)		
			$f 2$	$f 3$	$\alpha 1$	$\alpha 2$	$\alpha 3$
0.4, 0.75	5 min	Allowable continuous drive current $\times 150\%$	5 Hz	7 Hz	75	85	100
1.5 to 3.7					85	85	100
5.5 to 11				6 Hz	90	95	100
15				7 Hz	85	85	100
18.5, 22				5 Hz	92	100	100
30 to 45	10 min		Base frequency $\times 33\%$	Base frequency $\times 83\%$	54	85	95
55 to 90					51	95	95
110 or above					53	85	90

Nominal Applied Motor and Characteristic Factors when P99 (Motor 1 Selection) = 1

Nominal applied motor (HP)	Thermal time constant τ (Factory default)	Reference current for setting the thermal time constant (I_{max})	Output frequency for motor characteristic factor		Characteristic factor (%)		
			f2	f3	$\alpha 1$	$\alpha 2$	$\alpha 3$
1 to 30	5 min	Allowable continuous drive current $\times 150\%$	Base frequency $\times 33\%$	Base frequency $\times 33\%$	69	90	90
40 to 60	10 min			Base frequency $\times 83\%$	54	85	95
75 to 125					51	95	95
150 or above					53	85	90

If F10 is set to "2," changes of the output frequency do not affect the cooling effect. Therefore, the overload detection level (F11) remains constant.

■ Overload detection level (F11)

F11 specifies the level at which the electronic thermal overload protection becomes activated.

- Data setting range: 1 to 135% of the rated current (allowable continuous drive current) of the inverter

In general, set the F11 data to the allowable continuous current of motor when driven at the base frequency (i.e. 1.0 to 1.1 times of the rated current of the motor.) To disable the electronic thermal overload protection, set the F11 data to "OFF" (Disable).

■ Thermal time constant (F12)

F12 specifies the thermal time constant of the motor. If the current of 150% of the overload detection level specified by F11 flows for the time specified by F12, the electronic thermal overload protection becomes activated to detect the motor overload. The thermal time constant for general-purpose motors including Fuji motors is approx. 5 minutes for motors of 30 HP or below and 10 minutes for motors of 40 HP or above by factory default.

- Data setting range: 0.5 to 75.0 (minutes)

(Example) When the F12 data is set at 5 minutes

As shown on the next page, the electronic thermal overload protection is activated to detect an alarm condition (alarm code **OL1**) when the output current of 150% of the overload detection level (specified by F11) flows for 5 minutes, and 120% for approx. 12.5 minutes.

The actual time required for issuing a motor overload alarm tends to be shorter than the specified value, taking into account the time period from when the output current exceeds the allowable continuous drive current (100%) until it reaches 150% of the overload detection level.

Example of Thermal Overload Detection Characteristics

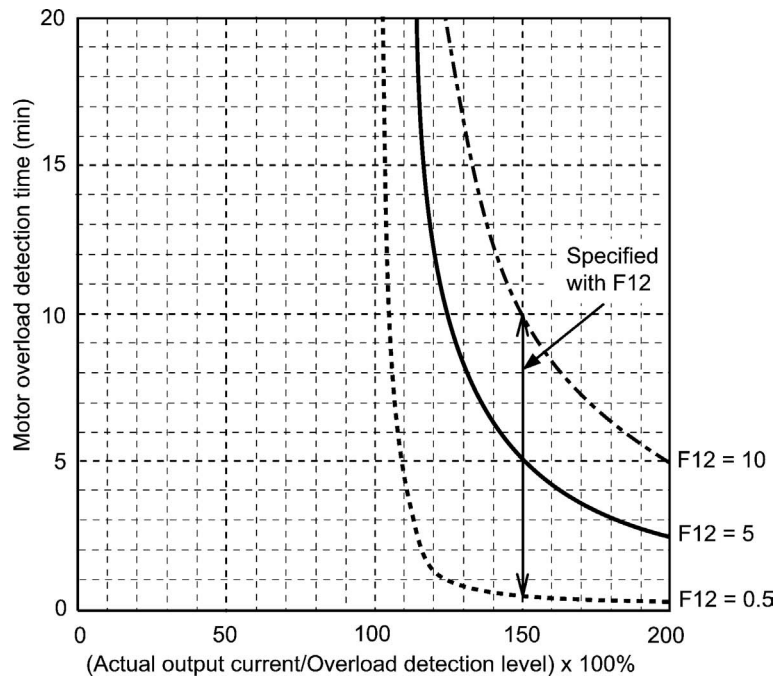

F14	Restart Mode after Momentary Power Failure (Mode selection) H13 (Restart time) H14 (Frequency fall rate) H15 (Continuous running level) H16 (Allowable momentary power failure time) H92 and H93 (Continuity of Running, P and I)
------------	--

F14 specifies the action to be taken by the inverter such as trip and restart in the event of a momentary power failure.

■ Restart mode after momentary power failure (Mode selection) (F14)

Data for F14	Description	
	Auto search disabled	Auto search enabled
0: Trip immediately	As soon as the DC link bus voltage drops below the undervoltage level due to a momentary power failure, the inverter issues undervoltage alarm LV and shuts down its output so that the motor enters a coast-to-stop state.	
1: Trip after recovery from power failure	As soon as the DC link bus voltage drops below the undervoltage level due to a momentary power failure, the inverter shuts down its output so that the motor enters a coast-to-stop state, but it does not enter the undervoltage state or issue undervoltage alarm LV . The moment the power is restored, an undervoltage alarm LV is issued, while the motor remains in a coast-to-stop state.	
3: Continue to run (for heavy inertia or general loads)	As soon as the DC link bus voltage drops below the continuous running level due to a momentary power failure, continuous running control is invoked. Continuous running control regenerates kinetic energy from the load's moment of inertia, continues running, and waits the recovery of power. When an undervoltage condition is detected due to a lack of energy to be regenerated, the output frequency at that time is saved, the output of the inverter is shut down, and the motor enters a coast-to-stop state.	
	If a run command has been input, restoring power restarts the inverter at the output frequency saved when undervoltage was detected.	If a run command has been input, restoring power performs auto search for idling motor speed and restarts running the motor at the frequency calculated based on the searched speed.
	This setting is ideal for fan applications with a large moment of inertia.	
4: Restart at the frequency at which the power failure occurred (for general loads)	As soon as the DC link bus voltage drops below the undervoltage level due to a momentary power failure, the inverter shuts down the output so that the motor enters a coast-to-stop state.	
	If a run command has been input, restoring power restarts the inverter at the output frequency saved when undervoltage was detected.	If a run command has been input, restoring power performs auto search for idling motor speed and restarts running the motor at the frequency calculated based on the searched speed.
	This setting is ideal for applications with a moment of inertia large enough not to slow down the motor quickly, such as fans, even after the motor enters a coast-to-stop state upon occurrence of a momentary power failure.	
5: Restart at the starting frequency	As soon as the DC link bus voltage drops below the undervoltage level due to a momentary power failure, the inverter shuts down the output so that the motor enters a coast-to-stop state.	
	If a run command has been input, restoring power restarts the inverter at the starting frequency specified by function code F23.	If a run command has been input, restoring power performs auto search for idling motor speed and restarts running the motor at the frequency calculated based on the searched speed.
	This setting is ideal for heavy load applications such as pumps, having a small moment of inertia, in which the motor speed quickly goes down to zero as soon as it enters a coast-to-stop state upon occurrence of a momentary power failure.	
Auto search is enabled by turning ON the digital terminal command STM ("Enable auto search for idling motor speed at starting") or setting the H09 data to "1" or "2." For details about the digital terminal command STM and auto search, refer to the description of H09 (Starting Mode, Auto search).		

■ Restart mode after momentary power failure (Basic operation: Auto search disabled)

The inverter recognizes a momentary power failure upon detecting the condition that DC link bus voltage goes below the undervoltage level, while the inverter is running. If the load of the motor is light and the duration of the momentary power failure is extremely short, the voltage drop may not be great enough for a momentary power failure to be recognized, and the motor may continue to run uninterrupted.

Upon recognizing a momentary power failure, the inverter enters the restart mode (after a recovery from momentary power failure) and prepares for restart. When power is restored, the inverter goes through an initial charging stage and enters the ready-to-run state. When a momentary power failure occurs, the power supply voltage for external circuits such as relay sequence circuits may also drop so as to turn the run command OFF. In consideration of such a situation, the inverter waits 2 seconds for a run command input after the inverter enters a ready-to-run state. If a run command is received within 2 seconds, the inverter begins the restart processing in accordance with the F14 data (Mode selection). If no run command has been received within 2-second wait period, the inverter cancels the restart mode (after a recovery from momentary power failure) and needs to be started again from the ordinary starting frequency. Therefore, ensure that a run command is entered within 2 seconds after recovery of power or held with an off-delay timer or a mechanical latch relay.

When run commands are entered via the keypad, the above operation is also necessary for the mode (F02 = 0) in which the rotational direction is determined by the terminal command, **FWD** or **REV**. In the modes where the rotational direction is fixed (F02 = 2 or 3), the run command is retained inside the inverter so that the restart will begin as soon as the inverter enters the ready-to-run state.

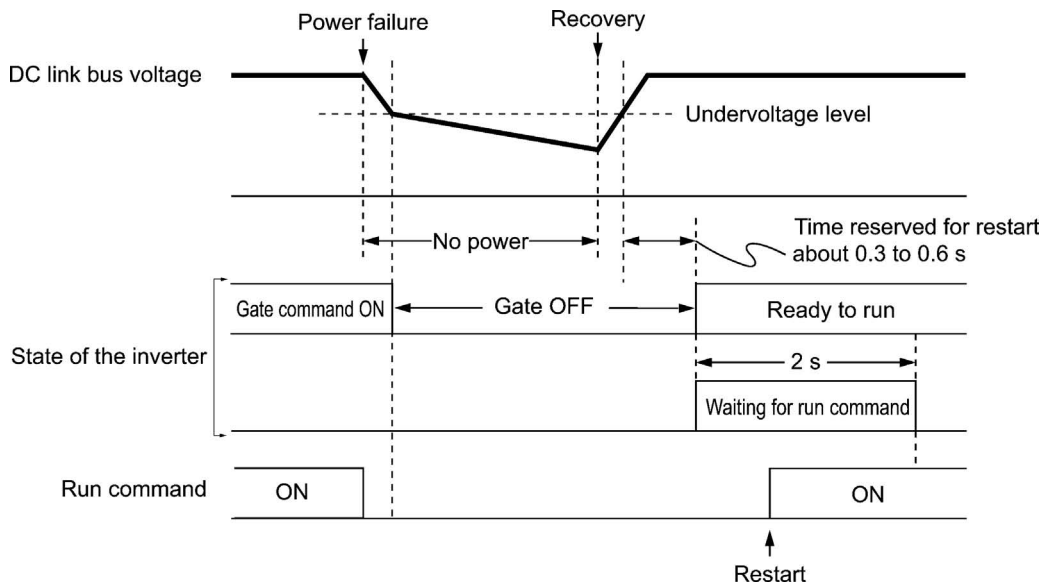



- When the power is restored, the inverter will wait 2 seconds for input of a run command. However, if the allowable momentary power failure time (H16) has elapsed after the power failure was recognized, the inverter will no longer wait 2 seconds for input of a run command and start operation in the normal starting sequence.
- If the terminal command **BX** ("Coast to a stop") is entered during the power failure, the inverter gets out of the restart mode and enters the normal running mode. When a run command is entered with power supply applied, the inverter will start from the normal starting frequency.
- The inverter recognizes a momentary power failure by detecting an undervoltage condition when the voltage of the DC link bus goes below the lower limit. In a configuration where a magnetic contactor is installed on the output side of the inverter, the inverter may fail to recognize a momentary power failure because the momentary power failure shuts down the operating power of the magnetic contactor, causing the contactor circuit to open. When the contactor circuit is open, the inverter is cut off from the motor and load so that the voltage drop in the DC link bus may not be great enough to be recognized as a power failure. In such an event, the restart after a recovery from momentary power failure does not work properly as designed. To solve this, connect the auxiliary contact of the magnetic contactor to the inverter terminal which the **IL** ("Interlock") is assigned to so that a momentary power failure can sure be detected.

For details about **IL**, refer to E01 to E07 (data = 22).

IL	Description
OFF	No momentary power failure has occurred.
ON	A momentary power failure has occurred. (Restart after a momentary power failure enabled)

During a momentary power failure, the motor slows down. After power is restored, the inverter restarts at the frequency just before the momentary power failure. Then, the current limiting function works and the output frequency of the inverter automatically decreases. When the output frequency matches the motor speed, the motor accelerates up to the original output frequency. See the figure below. In this case, the instantaneous overcurrent limiting must be enabled (H12 = 1).

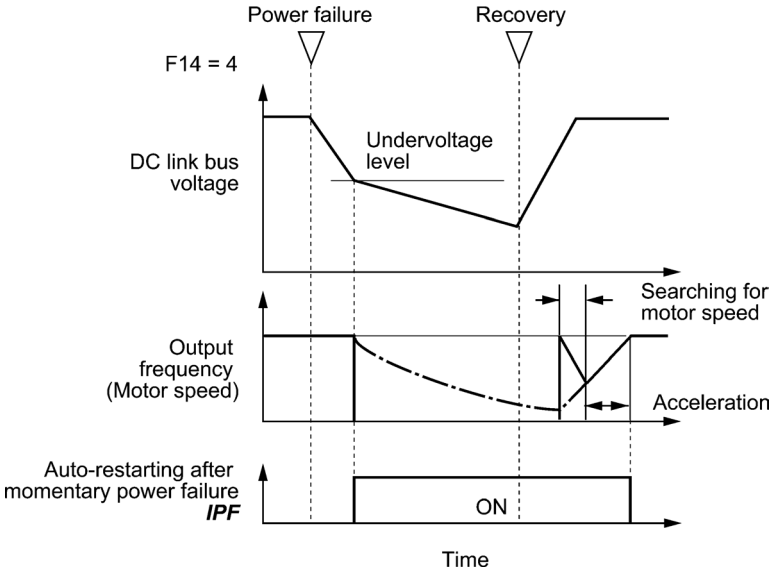

• Auto-restarting after momentary power failure **IPF**

This output signal is ON during the period after the occurrence of momentary power failure until the completion of a restart sequence (until the output reaches the reference frequency). When the **IPF** is ON, the motor slows down, so perform necessary operations.

For details about **IPF**, refer to E01 through E07 (data = 6).

■ Restart mode after momentary power failure (Basic operation: Auto search enabled)

Auto search for idling motor speed will become unsuccessful if it is done while the motor retains residual voltage. It is, therefore, necessary to leave the motor for the time (auto search delay time) enough to discharge the residual voltage. The delay time is specified by H46 (Starting Mode (Auto search delay time 2)).

The inverter will not start unless the time specified by H46 has elapsed, even if the starting conditions are satisfied. (For details, refer to H09.)

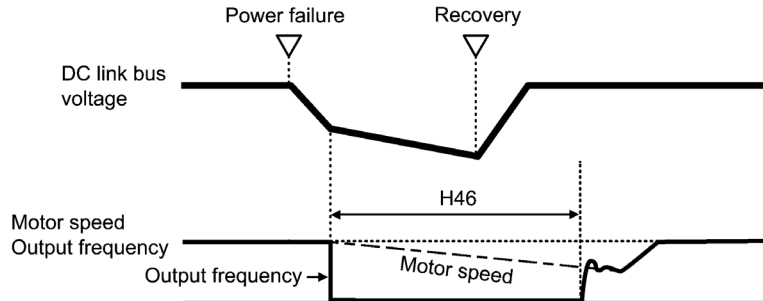

Note

- To use auto search for idling motor speed, it is necessary to tune the inverter beforehand.
- When the estimated speed exceeds the maximum frequency or the upper limit frequency, the inverter disables auto search and starts running the motor with the maximum frequency or the upper limit frequency, whichever is lower.
- During auto search, if an overcurrent or overvoltage trip occurs, the inverter restarts the suspended auto search.
- Perform auto search at 60 Hz or below.
- Note that auto search may not fully provide the performance depending on load conditions, motor parameters, wiring length, and other external factors.
- When the inverter is equipped with any of output circuit filters OFL-□□□-4 in the secondary lines, it cannot perform auto search. Use the filter OFL-□□□-4A instead.

■ Restart mode after momentary power failure (Allowable momentary power failure time) (H16)

H16 specifies the maximum allowable duration (0.0 to 30.0 seconds) from an occurrence of a momentary power failure (undervoltage) until the restart of the inverter. Specify the coast-to-stop time during which the machine system and facility can be tolerated.

If the power is restored within the specified duration, the inverter restarts in the restart mode specified by F14. If not, the inverter recognizes that the power has been shut down so that the inverter does not apply the restart mode and starts normal running.

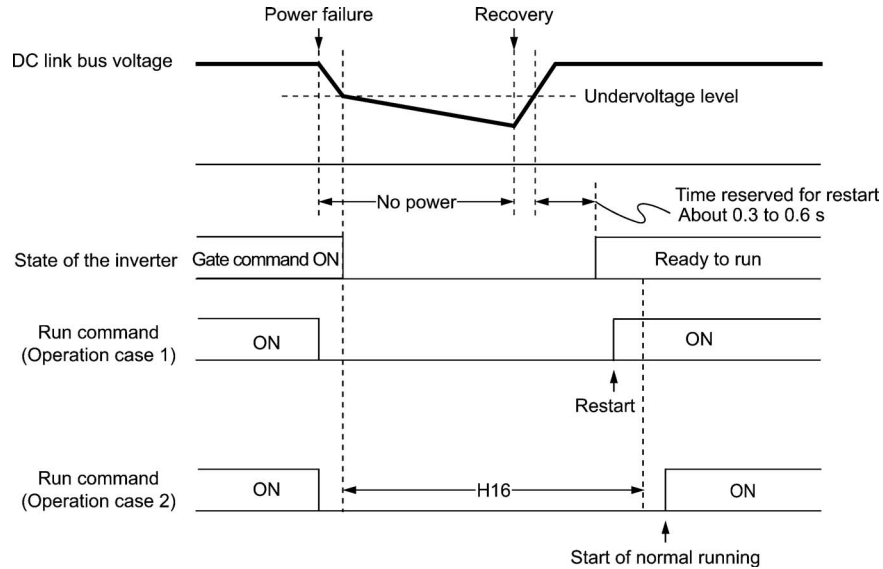

If H16 (Allowable momentary power failure time) is set to "Auto," restart will take place until the DC link bus voltage drops down to the allowable voltage (100 V) for restart after a momentary power failure. If the DC link bus voltage drops below the allowable voltage, the inverter recognizes that the power has been shut down so that the inverter does not apply the restart mode and starts normal running.

Note The time required from when the DC link bus voltage drops from the threshold of undervoltage until it reaches the allowable voltage for restart after a momentary power failure, greatly varies depending on the inverter capacity, the presence of options, and other factors.

■ Restart mode after momentary power failure (Restart time) (H13)

H13 specifies the time period from an occurrence of a momentary power failure until the restart of the inverter. (When auto search is enabled, H46 (Auto search delay time 2) applies.)

If the inverter starts the motor while motor's residual voltage is still in a high level, a high inrush current may flow or an overvoltage alarm may occur due to an occurrence of temporary regeneration. For safety, therefore, it is advisable to set H13 to a certain level so that the restart will take place only after the residual voltage has dropped to a low level. Note that even when power is restored, restart will not take place until the restart time (H13) has elapsed.

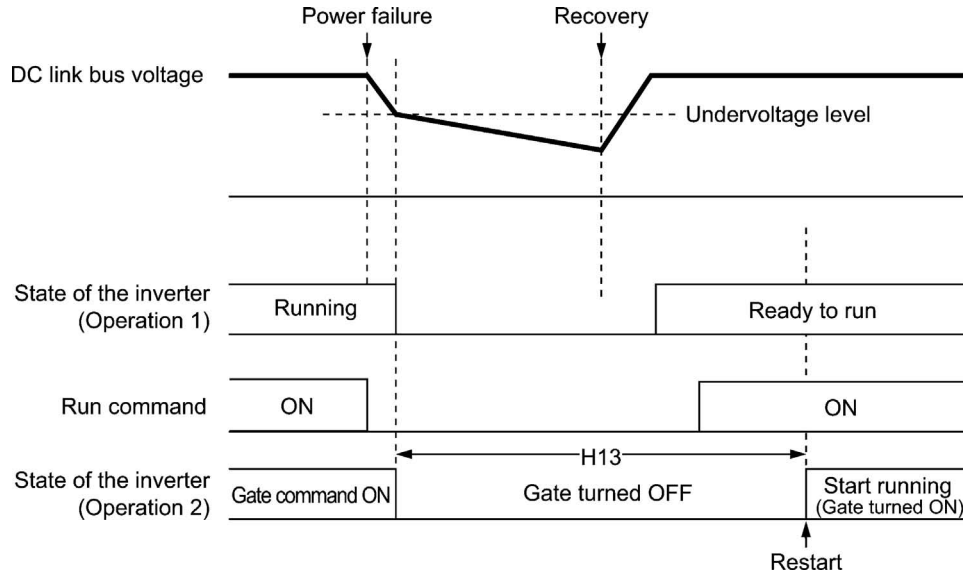

Factory default

By factory default, H13 is set to the value suitable for the standard motor (see Table A given in Section 6.2 "Function Code Tables"). Basically, it is not necessary to change H13 data. However, if the long restart time causes the flow rate of the pump to overly decrease or causes any other problem, you might as well reduce the setting to about a half of the default value. In such a case, make sure that no alarm occurs.

Note The restart time specified by H13 also applies to the switching operation (terminal commands *ISW50/ISW60*) between line and inverter. Refer to E01 through E07 (data = 40, 41) for terminals [X1] to [X7].

■ Restart mode after momentary power failure (Frequency fall rate) (H14)

During restart after a momentary power failure, if the inverter output frequency and the idling motor speed cannot be harmonized with each other, an overcurrent will flow, activating the overcurrent limiter. If it happens, the inverter automatically reduces the output frequency to match the idling motor speed according to the reduction rate (Frequency fall rate: Hz/s) specified by H14.

Data for H14	Inverter's action for the output frequency fall
Inherit	Fall frequency with the selected deceleration time
0.01 to 100.00 (Hz/s)	Follow the frequency fall rate specified by H14
Auto	Follow the setting of the PI processor in the current limiter. (The PI constant is prefixed inside the inverter.)

Note If the frequency fall rate is too high, regeneration may take place at the moment the motor speed matches the inverter output frequency, causing an overvoltage trip. On the contrary, if the frequency fall rate is too low, the time required for the output frequency to match the motor speed (duration of current limiting action) may be prolonged, triggering the inverter overload prevention control.

- Restart after momentary power failure (Continuous running level) (H15)
Continuity of running (P and I) (H92, H93)
- Continue to run (F14 = 3)

If a momentary power failure occurs when F14 is set to "3" (Continue to run), the inverter enters the control sequence of the continuous running when the DC link bus voltage drops below the continuous running level specified by H15.

Under the continuous running control, the inverter continues to run keeping the DC link bus voltage constant using the PI processor.

P (proportional) and I (integral) components of the PI processor are specified by H92 and H93, respectively.

For normal inverter operation, it is not necessary to modify data of H15, H92 or H93.

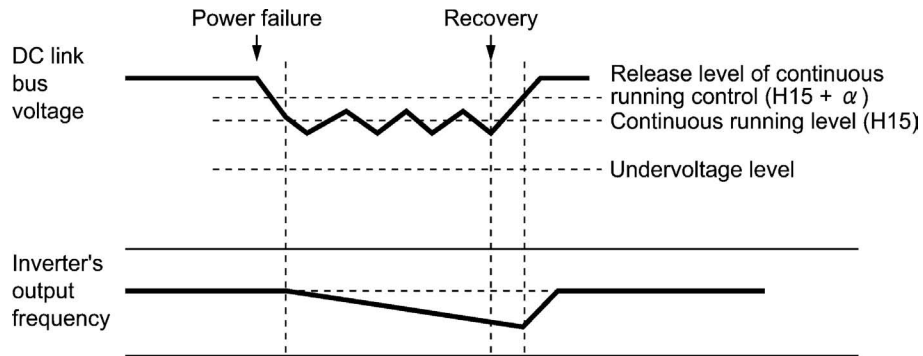

α	
30 HP or below	40 HP or above
230 V class series 5 V	230 V class series 10 V
460 V class series 10 V	460 V class series 20 V
575 V class series 14V	575 V class series 28V



Even if you select "Trip after decelerate-to-stop" or "Continue to run," the inverter may not be able to do so when the load's inertia is small or the load is heavy, due to undervoltage caused by a control delay. In such a case, when "Trip after decelerate-to-stop" is selected, the inverter allows the motor to coast to a stop; when "Continue to run" is selected, the inverter saves the output frequency being applied when the undervoltage alarm occurred and restarts at the saved frequency after a recovery from the momentary power failure.

When the input power voltage for the inverter is high, setting the continuous running level high makes the control more stable even if the load's inertia is relatively small. Raising the continuous running level too high, however, might cause the continuous running control activated even during normal operation.

When the input power voltage for the inverter is extremely low, continuous running control might be activated even during normal operation, at the beginning of acceleration or at an abrupt change in load. To avoid this, lower the continuous running level. Lowering it too low, however, might cause undervoltage that results from voltage drop due to a control delay.

Before you change the continuous running level, make sure that the continuous running control will be performed properly, by considering the fluctuations of the load and the input voltage.

■ Frequency Limiter (High and Low) (F15, F16)

F15 and F16 specify the upper and lower limits of the output frequency or reference frequency, respectively. The object to which the limit is applied differs depending on the control system.

Frequency Limiter		Object to which the limit is applied	
Frequency Limiter (High)	F15	Output frequency	Reference speed (reference frequency)
Frequency Limiter (Low)	F16	Reference frequency	Reference speed (reference frequency)
 Note When the limit is applied to the reference frequency or reference speed, delayed responses of control may cause an overshoot or undershoot, and the frequency may temporarily go beyond the limit level.			

- Data setting range: 0.0 to 120.0 (Hz)

■ Low Limiter (Mode selection) (H63)

H63 specifies the operation to be carried out when the reference frequency drops below the low level specified by F16, as follows:

Data for H63	Operation
0	The output frequency will be held at the low level specified by F16.
1	The inverter decelerates to stop the motor.

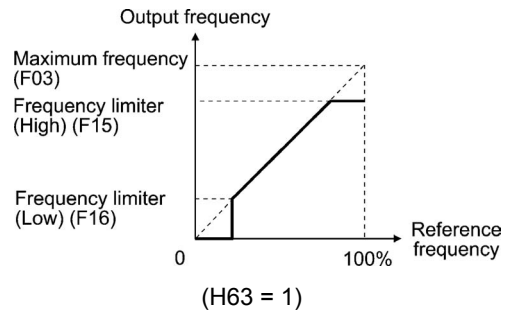
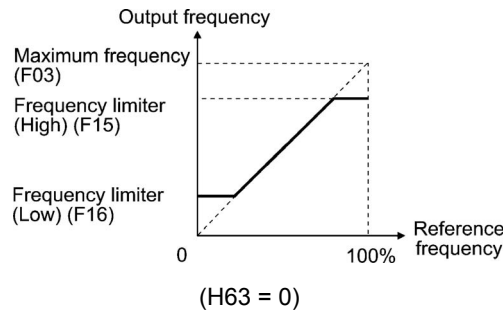

- 
 • When you change the frequency limiter (High) (F15) in order to raise the reference frequency, be sure to change the maximum frequency (F03) accordingly.
- Maintain the following relationship among the data for frequency control:
 $F15 > F16, F15 > F23, \text{ and } F15 > F25$
 $F03 > F16$

where, F23 and F25 specify the starting and stop frequencies, respectively.

If you specify any wrong data for these function codes, the inverter may not run the motor at the desired speed, or cannot start it normally.

F18	Bias (Frequency command 1)	Refer to F01.
------------	-----------------------------------	----------------------

Refer to the description of F01.

F20 to F22 H95	DC Braking 1 (Braking starting frequency, Braking level and Braking time) DC Braking (Braking response mode)
---------------------------	---

These function codes specify the DC braking that prevents motor 1 from running by inertia during decelerate-to-stop operation.

If the motor enters a decelerate-to-stop operation by turning OFF the run command or by decreasing the reference frequency below the stop frequency, the inverter activates the DC braking by flowing a current at the braking level (F21) for the braking time (F22) when the output frequency goes down to the DC braking starting frequency (F20).

Setting the braking time to "OFF" disables the DC braking.

■ **Braking starting frequency (F20)**

F20 specifies the frequency at which the DC braking starts its operation during motor decelerate-to-stop state.

- Data setting range: 0.0 to 60.0 (Hz)

■ **Braking level (F21)**

F21 specifies the output current level to be applied when the DC braking is activated. The function code data should be set, assuming the rated output current of the inverter as 100%, in increments of 1%.

- Data setting range: 0 to 60 (%)

 **Note** The inverter rated output current differs between the HD and MD/LD modes.

■ **Braking time (F22)**

F22 specifies the braking period that activates DC braking.

- Data setting range: 0.01 to 30.00 (s)
OFF (Disable)

■ **Braking response mode (H95)**

H95 specifies the DC braking response mode.

Data for H95	Characteristics	Note
0	Slow response. Slows the rising edge of the current, thereby preventing reverse rotation at the start of DC braking.	Insufficient braking torque may result at the start of DC braking.
1	Quick response. Quickens the rising edge of the current, thereby accelerating the build-up of the braking torque.	Reverse rotation may result depending on the moment of inertia of the mechanical load and the coupling mechanism.

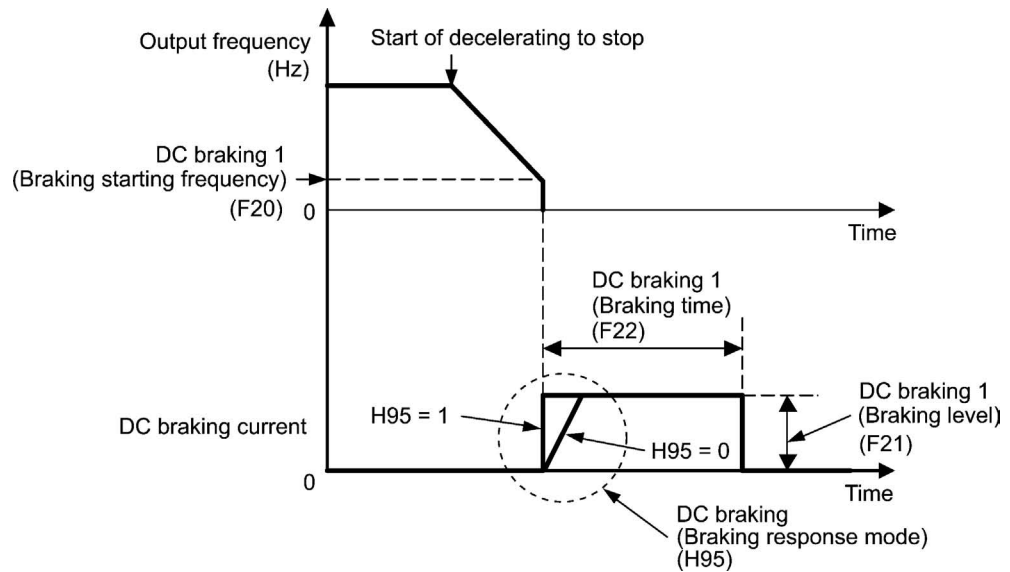

Tip It is also possible to use an external digital input signal as the terminal command **DCBRK** ("Enable DC braking").

As long as the **DCBRK** is ON, the inverter performs DC braking, regardless of the braking time specified by F22.

For details about **DCBRK**, refer to E01 through E07 (data = 13).

Turning the **DCBRK** ON even when the inverter is in a stopped state activates the DC braking. This feature allows the motor to be excited before starting, resulting in smoother acceleration (quicker build-up of acceleration torque).

Note In general, specify data of function code F20 at a value close to the rated slip frequency of motor. If you set it at an extremely high value, control may become unstable and an overvoltage alarm may result in some cases.

⚠ CAUTION

The DC braking function of the inverter does not provide any holding mechanism.

Injuries could occur.

F23 to F25

Starting Frequency 1, Starting Frequency 1 (Holding time), and Stop Frequency

At the startup of an inverter, the initial output frequency is equal to the starting frequency. The inverter stops its output when the output frequency reaches the stop frequency.

Set the starting frequency to a level at which the motor can generate enough torque for startup. Generally, set the motor's rated slip frequency as the starting frequency.

■ Starting Frequency 1 (F23)

F23 specifies the starting frequency at the startup of an inverter.

- Data setting range: 0.1 to 60.0 (Hz)

■ Starting Frequency 1 (Holding time) (F24)

F24 specifies the holding time during which the inverter runs at the starting frequency 1 at the time of startup.

- Data setting range: 0.00 to 10.00 (s)

■ Stop Frequency (F25)

F25 specifies the stop frequency at the stop of the inverter.

- Data setting range: 0.1 to 60.0 (Hz)

 **Note** If the starting frequency is lower than the stop frequency, the inverter does not output any power as long as the reference frequency does not exceed the stop frequency.

■ Motor Sound (Carrier frequency) (F26)

F26 controls the carrier frequency so as to reduce an audible noise generated by the motor or electromagnetic noise from the inverter itself, and to decrease a leakage current from the main output (secondary) wirings.

Item	Characteristics	Remarks
Carrier frequency	0.75 to 16 kHz	230 V class series:1 to 25 HP 460 V class series:1 to 50 HP 575 V class series:1 to 50 HP
	0.75 to 10 kHz	230 V class series:30 to 100 HP 460 V class series:60 to 125 HP 575 V class series:60 to 125 HP
	0.75 to 6 kHz	230 V class series: 125 HP 460 V class series:150 to 900 HP 575 V class series:150 to 300 HP
	0.75 to 4 kHz	460 V class series: 1000 HP
Motor sound noise emission	High ↔ Low	
Motor temperature (due to harmonics components)	High ↔ Low	
Ripples in output current waveform	Large ↔ Small	
Leakage current	Low ↔ High	
Electromagnetic noise emission	Low ↔ High	
Inverter loss	Low ↔ High	

Note Basically, do not change the carrier frequency from the default value (2 kHz). Increasing it requires derating of the output current. For details, refer to Chapter 2, Section 2.6 "Derating of Rated Output Current."

When a high carrier frequency is specified, the temperature of the inverter may rise due to an ambient temperature rise or an increase of the load. If it happens, the inverter automatically decreases the carrier frequency to prevent the inverter overload alarm **OLV**. With consideration for motor noise, the automatic reduction of carrier frequency can be disabled. Refer to the description of H98.

■ Motor Sound (Tone) (F27)

F27 changes the motor running sound tone. This setting is effective when the carrier frequency specified by function code F26 is 7 kHz or lower. Changing the tone level may reduce the high and harsh running noise from the motor.

Data for F27	Function
0	Disable (Tone level 0)
1	Enable (Tone level 1)
2	Enable (Tone level 2)
3	Enable (Tone level 3)

Note If the tone level is set too high, the output current may become unstable, or mechanical vibration and noise may increase. Also, this function code may not be very effective for certain types of motor.

F29 to F31	Analog Output [FM1] (Mode selection, Voltage adjustment, Function) F35 ([FM2] (Function))
-------------------	--

These function codes allow terminal [FM1] to output monitored data such as the output frequency and the output current in an analog DC voltage or current. The magnitude of such analog voltage or current is adjustable.

■ Mode selection (F29)

F29 specifies the output form of the terminal [FM1]. You need to set switch SW4 on the control printed circuit board (control PCB).

 For details of the slide switches on the control PCB, refer to Chapter 2 "SPECIFICATIONS."

Data for F29	[FM1] output form	Position of slide switch SW4 mounted on the control PCB
0	Voltage (0 to +10 VDC)	VO1
1	Current (4 to +20 mA DC)	IO1
2	Current (0 to +20 mA DC)	IO1

 **Note** The output current is not isolated from analog input, and does not have an isolated power supply. Therefore, if an electrical potential relationship between the inverter and peripheral equipment has been established, e.g., by connecting an analog, cascade connection of a current output device is not available.

Keep the connection wire length as short as possible.

■ Voltage adjustment (F30)

F30 allows you to adjust the output voltage within the range of 0 to 300%.

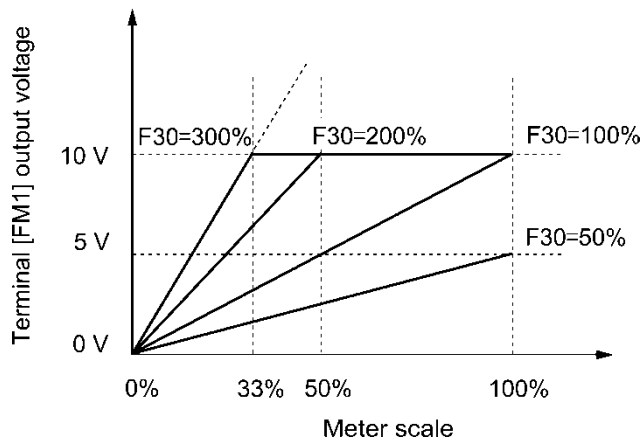

■ Function (F31, F35)

F31 or F35 specifies what is output to analog output terminal [FM1] or [FM2], respectively.

Data for F31, F35	[FM1] output	Function (Monitor the following)	Meter scale (Full scale at 100%)
0	Output frequency 1 (before slip compensation)	Output frequency of the inverter (Equivalent to the motor synchronous speed)	Maximum frequency (F03)
1	Output frequency 2 (after slip compensation)	Output frequency of the inverter	Maximum frequency (F03)
2	Output current	Output current (RMS) of the inverter	Twice the inverter rated current
3	Output voltage	Output voltage (RMS) of the inverter	500 V
4	Output torque	Motor shaft torque	Twice the rated motor torque
5	Load factor	Load factor (Equivalent to the indication of the load meter)	Twice the rated motor load
6	Input power	Input power of the inverter	Twice the rated output of the inverter
7	PID feedback amount	Feedback amount under PID control	100% of the feedback amount
9	DC link bus voltage	DC link bus voltage of the inverter	1000 V
10	Universal AO	Command via communications link (Refer to the RS-485 Communication User's Manual.)	20000 as 100%
13	Motor output	Motor output (kW)	Twice the rated motor output
14	Calibration (+)	Full scale output for the meter calibration	This always outputs the full-scale (100%).
15	PID command (SV)	Command value under PID control	100% of the feedback amount
16	PID output (MV)	Output level of the PID processor under PID control (Frequency command)	Maximum frequency (F03)
18	Inverter heat sink temperature	Heat sink temperature inside the inverter unit	0 to 200°C (32 to 392°F)
20	Reference frequency	Frequency command input to the inverter	Maximum frequency (F03)
50	PID feedback amount 1 (PV1)	Feedback amount under PID control	100% of the feedback amount
51	PID command 1 (SV1)	Command value 1 under PID control	100% of the feedback amount
52	PID deviation 1 (ERR1)	Deviation 1 under PID control (SV1 - PV1) (*1)	100% of the feedback amount
53	PID final deviation (ERR)	Final deviation under PID control (ERR1, ERR2) (*1)	100% of the feedback amount
54	PID feedback amount 2 (PV2)	Feedback amount 2 under PID control	100% of the feedback amount
55	PID command 2 (SV2)	Command value 2 under PID control	100% of the feedback amount
56	PID deviation 2 (ERR2)	Deviation 2 (SV2-PV2) under PID control (*1)	100% of the feedback amount
60	External PID feedback amount 1 (EPID1-PV)	Feedback amount under external PID control 1	100% of the feedback amount
61	External PID command 1 (EPID1-SV)	Command value under external PID control 1	100% of the feedback amount

Data for F31, F35	[FM1] output	Function (Monitor the following)	Meter scale (Full scale at 100%)
62	External PID deviation 1 (EPID1-ERR)	Deviation under external PID control 1 (*1)	100% of the feedback amount
63	External PID final deviation 1 (EPID1-ERR)	Final deviation under external PID control 1 (*1)	100% of the feedback amount
65	External PID final output 1 (EPID1-OUT)	Final output under external PID control 1	100% of the feedback amount
70	External PID feedback amount 2 (EPID2-PV)	Feedback amount under external PID control 2	100% of the feedback amount
71	External PID command 2 (EPID2-SV)	Command value under external PID control 2	100% of the feedback amount
72	External PID deviation 2 (EPID2-ERR)	Deviation under external PID control 2 (*1)	100% of the feedback amount
75	External PID final output 2 (EPID2-OUT)	Final output under external PID control 2	100% of the feedback amount
80	External PID feedback amount 3 (EPID3-PV)	Feedback amount under external PID control 3	100% of the feedback amount
81	External PID command 3 (EPID3-SV)	Command value under external PID control 3	100% of the feedback amount
82	External PID deviation 3 (EPID3-ERR)	Deviation under external PID control 3 (*1)	100% of the feedback amount
85	External PID final output 3 (EPID3-OUT)	Final output under external PID control 3	100% of the feedback amount
111	Customizable logic output signal 1	--	100% of the feedback amount
112	Customizable logic output signal 2	--	100% of the feedback amount
113	Customizable logic output signal 3	--	100% of the feedback amount
114	Customizable logic output signal 4	--	100% of the feedback amount
115	Customizable logic output signal 5	--	100% of the feedback amount
116	Customizable logic output signal 6	--	100% of the feedback amount
117	Customizable logic output signal 7	--	100% of the feedback amount

(*1) Deviation output is supported only by option terminal [Ao]. (Function code o90)

F32, F34,
F35

Pulse Output [FM2] (Mode selection, Voltage adjustment, Function)

These function codes allow terminal [FM2] to output monitored data such as the output frequency and the output current in an analog DC voltage or current. The magnitude of such analog voltage or current is adjustable.

■ Mode selection (F32)

F29 specifies the output form of the terminal [FM2]. You need to set switch SW6 on the control printed circuit board (control PCB).



For details of the slide switches on the control PCB, refer to Chapter 2 "SPECIFICATIONS."

Data for F32	[FM2] output form	Position of slide switch SW6 mounted on the control PCB
0	Voltage (0 to +10 VDC)	VO2
1	Current (4 to +20 mA DC)	IO2
2	Current (0 to +20 mA DC)	IO2



The output current is not isolated from analog input, and does not have an isolated power supply. Therefore, if an electrical potential relationship between the inverter and peripheral equipment has been established, e.g., by connecting an analog, cascade connection of a current output device is not available.

Keep the connection wire length as short as possible.

■ Voltage adjustment (F34)

F34 allows you to adjust the output voltage within the range of 0 to 300%.

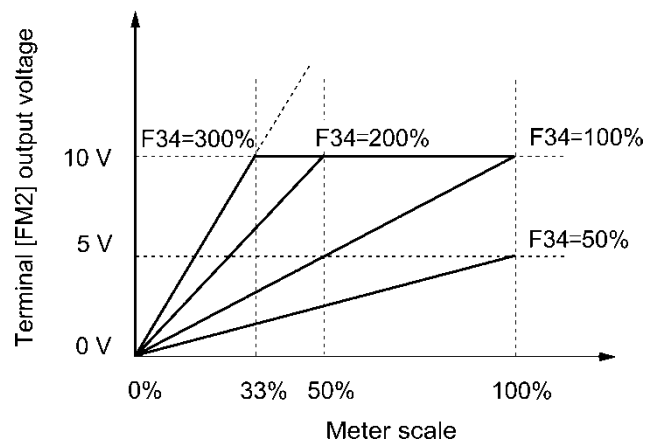

■ Function (F35)

F35 specifies what is output to analog output terminal [FM2]. The monitor objects are the same as for F31. Refer to the description of F31.

F37	Load Selection/Auto Torque Boost/Auto Energy Saving Operation 1 F09 (Torque Boost 1)
------------	---

F09 specifies the torque boost level in order to assure sufficient starting torque.

F37 specifies V/f pattern, torque boost type, and auto energy saving operation in accordance with the characteristics of the load.

Data for F37	V/f pattern	Torque boost	Auto energy saving	Applicable load
0	Variable torque V/f pattern	Torque boost specified by F09	Disable	Variable torque load (General-purpose fans and pumps)
1	Linear V/f pattern			Constant torque load
2		Auto torque boost		Constant torque load (To be selected if a motor may be over-excited at no load.)
3	Variable torque V/f pattern	Torque boost specified by F09	Enable	Variable torque load (General-purpose fans and pumps)
4	Linear V/f pattern			Constant torque load
5		Auto torque boost		Constant torque load (To be selected if a motor may be over-excited at no load.)

Note If a required "load torque + acceleration torque" is more than 50% of the motor rated torque, it is recommended to select the linear V/f pattern (factory default).

■ V/f characteristics

The FRENIC-HVAC series of inverters offer a variety of V/f patterns and torque boosts, which include V/f patterns suitable for variable torque load such as general fans and pumps and for constant torque load (including special pumps requiring high starting torque). Two types of torque boosts are available: manual and automatic.

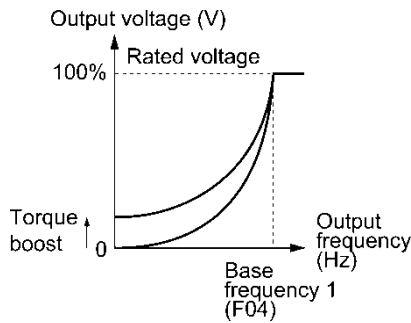

Variable torque V/f pattern (F37 = 0)

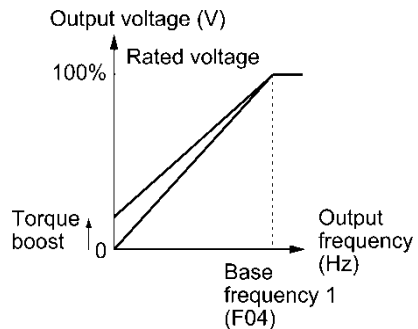

Linear V/f pattern (F37 = 1)



When the variable torque V/f pattern is selected (F37 = 0 or 3), the output voltage may be low at a low frequency zone, resulting in insufficient output torque, depending on the characteristics of the motor and load. In such a case, it is recommended to increase the output voltage at the low frequency zone using the non-linear V/f pattern.

Recommended value: $H50 = 1/10$ of the base frequency
 $H51 = 1/10$ of the voltage at base frequency

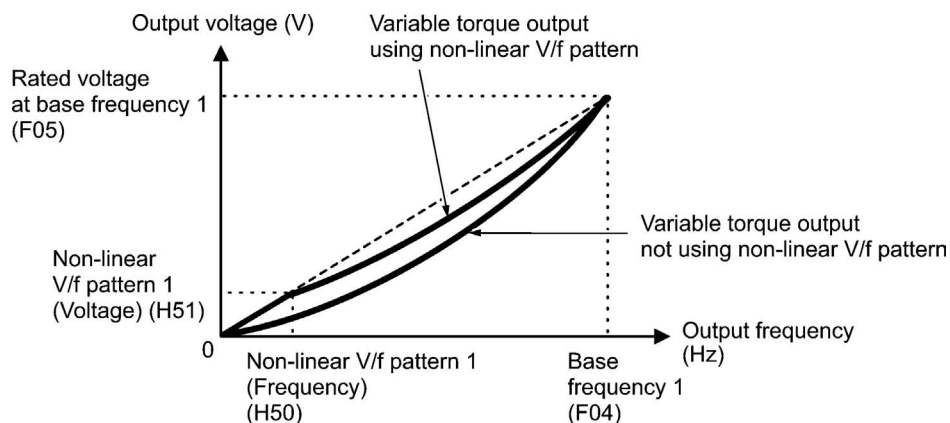

■ Torque boost

- Manual torque boost (F09)

- Data setting range: 0.0 to 20.0 (%), (100%/Rated voltage at base frequency)

In torque boost using F09, constant voltage is added to the basic V/f pattern, regardless of the load. To secure a sufficient starting torque, manually adjust the output voltage to optimally match the motor and its load by using F09. Specify an appropriate level that guarantees smooth start-up and yet does not cause over-excitation at no or light load.

Torque boost using F09 ensures high driving stability since the output voltage remains constant regardless of the load fluctuation.

Specify the F09 data in percentage to the rated voltage at base frequency 1 (F05). At factory shipment, F09 is preset to a level that assures approx. 50% of starting torque.



- Specifying a high torque boost level will generate a high torque, but may cause overcurrent due to over-excitation at no load. If you continue to drive the motor, it may overheat. To avoid such a situation, adjust torque boost to an appropriate level.
- When the non-linear V/f pattern and the torque boost are used together, the torque boost takes effect below the frequency on the non-linear V/f pattern's point.

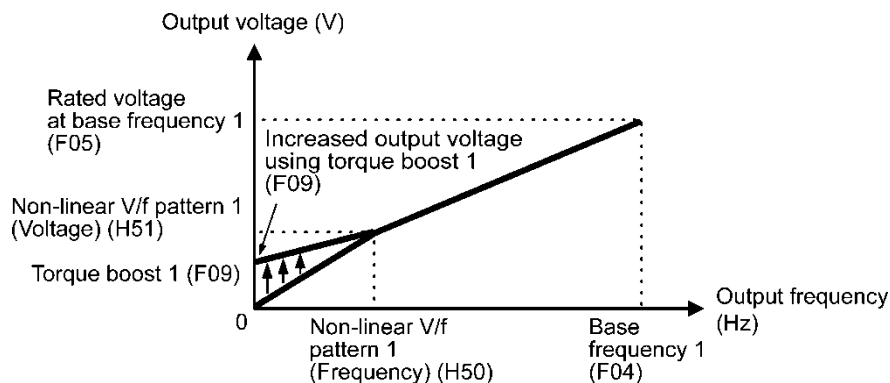

- Auto torque boost

This function automatically optimizes the output voltage to fit the motor with its load. Under light load, auto torque boost decreases the output voltage to prevent the motor from over-excitation. Under heavy load, it increases the output voltage to increase the output torque of the motor.

- Note**
- Since this function relies also on the characteristics of the motor, set the base frequency 1 (F04), the rated voltage at base frequency 1 (F05), and other pertinent motor parameters (P01 through P03 and P06 through P99) in line with the motor capacity and characteristics, or else perform auto-tuning (P04).
 - When a special motor is driven or the load does not have sufficient rigidity, the maximum torque might decrease or the motor operation might become unstable. In such cases, do not use auto torque boost but choose manual torque boost using F09 (F37 = 0 or 1).

- Auto energy saving operation

This feature automatically controls the supply voltage to the motor to minimize the total power loss of motor and inverter. (Note that this feature may not be effective depending upon the motor or load characteristics. Check the advantage of energy saving before you actually apply this feature to your machinery.)

Auto energy saving operation applies only to constant speed operation. During acceleration/deceleration, torque boost specified by F09 or auto torque boost applies depending upon the setting of F37.

If auto energy saving operation is enabled, the response to a motor speed change from constant speed operation may be slow. Do not use this feature for such machinery that requires quick acceleration/deceleration.

- Note**
- Use auto energy saving only where the base frequency is 60 Hz or lower. If the base frequency is set at 60 Hz or higher, you may get a little or no energy saving advantage. The auto energy saving operation is designed for use with the frequency lower than the base frequency. If the frequency becomes higher than the base frequency, the auto energy saving operation will be invalid.
 - Since this function relies also on the characteristics of the motor, set the base frequency 1 (F04), the rated voltage at base frequency 1 (F05), and other pertinent motor parameters (P01 through P03 and P06 through P99) in line with the motor capacity and characteristics, or else perform auto-tuning (P04).

F40, F41

Torque Limiter 1 (Driving, Braking)

**E16 and E17 (Torque Limiter 2 (Driving, Braking))
H76 (Torque Limiter for Braking, Frequency increment limit)**

If the inverter's output torque exceeds the specified levels of the torque limiters (F40, F41, E16 and E17), the inverter controls the output frequency and limits the output torque for preventing a stall.

To use the torque limiters, it is necessary to configure the function codes listed in the table below.



In braking, the inverter increases the output frequency to limit the output torque. Depending on the conditions during operation, the output frequency could dangerously increase. H76 (Frequency increment limit) is provided to limit the increasing frequency component.

■ Torque limiters 1 and 2 (F40, F41, E16 and E17)

Data setting range: 20 to 150 (%), OFF (Disable)

These function codes specify the operation level at which the torque limiters become activated, as the percentage of the motor rated torque.

Function code	Name	Torque limit feature
F40	Torque limiter 1 (Driving)	Driving torque current limiter 1
F41	Torque limiter 1 (Braking)	Braking torque current limiter 1
E16	Torque limiter 2 (Driving)	Driving torque current limiter 2
E17	Torque limiter 2 (Braking)	Braking torque current limiter 2

■ Torque limiter levels specified via communications link (S10, S11)

The torque limiter levels can be changed via the communications link. Function codes S10 and S11 exclusively reserved for the communications link respond to function codes F40 and F41.

■ Switching torque limiters

The torque limiters can be switched by the function code setting and the terminal command **TL2/TL1** ("Select torque limiter level 2/1") assigned to any of the digital input terminals.

To assign the **TL2/TL1** as the terminal function, set any of E01 through E07 to "14." If no **TL2/TL1** is assigned, torque limiter level 1 (F40 and F41) take effect by default.

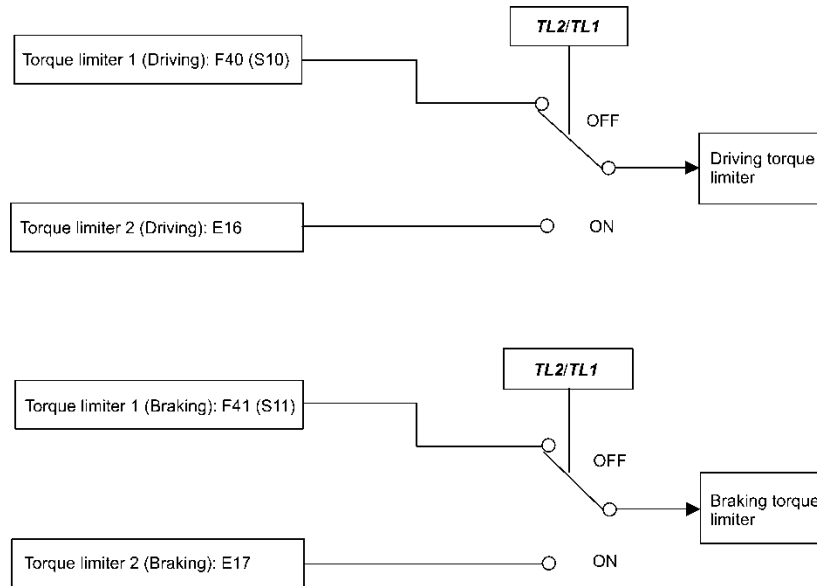

■ Torque limiter for braking (Frequency increment limit) (H76)

Data setting range: 0.0 to 120.0 (Hz)

H76 specifies the increment limit of the frequency in limiting torque for braking. The factory default is 5.0 Hz. If the increasing frequency during braking reaches the limit value, the torque limiters no longer function, resulting in an overvoltage trip. Such a problem may be avoided by increasing the setting value of H76.

Note The torque limiter and current limiter are very similar in function. If both are activated concurrently, they may conflict with each other and cause hunting (undesirable oscillation of the system). Avoid concurrent activation of these limiters.

F42 specifies the motor drive control.

Data for F42	Drive control	Basic control	Speed feedback	Speed control
0	V/f control with slip compensation inactive	V/f control	Disable	Frequency control
1	Dynamic torque vector control (with slip compensation and auto torque boost)			Frequency control with slip compensation
2	V/f control with slip compensation active			

■ V/f control with slip compensation inactive

Under this control, the inverter controls a motor with the voltage and frequency according to the V/f pattern specified by function codes. This control disables all automatically controlled features such as the slip compensation, so no unpredictable output fluctuation occurs, enabling stable operation with constant output frequency.

■ V/f control with slip compensation active

Applying any load to an induction motor causes a rotational slip due to the motor characteristics, decreasing the motor rotation. The inverter's slip compensation function first presumes the slip value of the motor based on the motor torque generated and raises the output frequency to compensate for the decrease in motor rotation. This prevents the motor from decreasing the rotation due to the slip.

That is, this function is effective for improving the motor speed control accuracy.

Function code		Operation
P12	Rated slip frequency	Specify the rated slip frequency.
P10	Slip compensation response time	Specify the slip compensation response time. Basically, there is no need to modify the default setting.

To improve the accuracy of slip compensation, perform auto-tuning.

H68 enables or disables the slip compensation function according to the motor driving conditions.

Data for H68	Motor driving conditions		Motor driving frequency zone	
	Accel/Decel	Constant speed	Base frequency or below	Above the base frequency
0	Enable	Enable	Enable	Enable
1	Disable	Enable	Enable	Enable
2	Enable	Enable	Enable	Disable
3	Disable	Enable	Enable	Disable

■ Dynamic torque vector control

To get the maximal torque out of a motor, this control calculates the motor torque matched to the load applied and uses it to optimize the voltage and current vector output.

Selecting this control automatically enables the auto torque boost and slip compensation function so that it is effective for improving the system response to external disturbances such as load fluctuation, and the motor speed control accuracy.

Note that the inverter may not respond to a rapid load fluctuation since this control is an open-loop V/f control that does not perform current control, unlike vector control. Other advantage of this control is that the maximum torque per output current is larger than that of vector control.

 Since slip compensation and dynamic torque vector control use motor parameters, the following conditions should be satisfied to obtain full control performance.

- A single motor is controlled per inverter.
- Motor parameters P02, P03, P06 to P12 are properly configured. Or, auto-tuning (P04) is performed.
- Under dynamic torque vector control, the capacity of the motor to be controlled is two or more ranks lower than that of the inverter. Otherwise, the inverter may not control the motor due to decrease of the current detection resolution.
- The wiring distance between the inverter and motor is 164 ft (50 m) or less. If it is longer, the inverter may not control the motor due to leakage current flowing through stray capacitance to the ground or between wires. Especially, small capacity inverters whose rated current is also small may be unable to control the motor correctly even if the wiring is less than 164 ft (50 m). In that case, make the wiring length as short as possible or use a wire with small stray capacitance (e.g., loosely-bundled cable) to minimize the stray capacitance.

When the output current of the inverter exceeds the level specified by the current limiter (F44), the inverter automatically manages its output frequency to prevent a stall and limits the output current. The default of the current limiter level is 120%. Do not change the factory default except when necessary.

The current limiter mode is selected with F43. If F43 = 1, the current limiter is enabled only during constant speed operation. If F43 = 2, it is enabled during both of acceleration and constant speed operation. Choose F43 = 1 if you need to run the inverter at full capability during acceleration and to limit the output current during constant speed operation.

■ Mode selection (F43)

F43 selects the motor running state in which the current limiter becomes activated.

Data for F43	Running states that enable the current limiter		
	During acceleration	During constant speed	During deceleration
0	Disable	Disable	Disable
1	Disable	Enable	Disable
2	Enable	Enable	Disable

■ Level (F44)

F44 specifies the operation level at which the output current limiter becomes activated, in ratio to the inverter rating.

- Data setting range: 20 to 120 (%) (in ratio to the inverter rating)

■ Instantaneous Overcurrent Limiting (Mode selection) (H12)

H12 specifies whether the inverter invokes the current limit processing or enters the overcurrent trip when its output current exceeds the instantaneous overcurrent limiting level. Under the current limit processing, the inverter immediately turns OFF its output gate to suppress the further current increase and continues to control the output frequency.

Data for H12	Function
0	Disable An overcurrent trip occurs at the instantaneous overcurrent limiting level.
1	Enable

If any problem could occur when the motor torque temporarily drops during current limiting processing, it is necessary to cause an overcurrent trip (H12 = 0) and actuate a mechanical brake at the same time.



- Since the current limit operation with F43 and F44 is performed by software, it may cause a delay in control. If you need a quick response current limiting, also enable the instantaneous overcurrent limiting with H12.



- If an excessive load is applied when the current limiter operation level is set extremely low, the inverter will rapidly lower its output frequency. This may cause an overvoltage trip or dangerous turnover of the motor rotation due to undershooting. Depending on the load, extremely short acceleration time may activate the current limiting to suppress the increase of the inverter output frequency, causing hunting (undesirable oscillation of the system) or activating the inverter overvoltage trip (alarm OU). When specifying the acceleration time, therefore, you need to take into account machinery characteristics and moment of inertia of the load.
- The torque limiter and current limiter are very similar in function. If both are activated concurrently, they may conflict with each other and cause hunting. Avoid concurrent activation of these limiters.

6.3.2 E codes (Extension terminal functions)

E01 to E07

Terminal [X1] to [X7] Functions

E98 and E99 (Terminal [FWD] and [REV] Functions)

E01 to E07, E98 and E99 assign commands (listed below) to general-purpose, programmable, digital input terminals, [X1] to [X7], [FWD], and [REV].

These function codes can also switch the logic system between normal and negative to define how the inverter logic interprets the ON or OFF state of each terminal. The factory default setting is normal logic system "Active ON." So, descriptions that follow are given in normal logic system. They are, in principle, arranged in the numerical order of assigned data. However, highly relevant signals are collectively described where one of them first appears. Refer to the function codes in the "Related function codes" column, if any.

⚠ CAUTION

- Ensure safety before modifying the function code settings.
Run commands (e.g., "Run forward" *FWD* and "Fire mode" *FMS*), stop commands (e.g., "Coast to a stop" *BX*), and frequency change commands can be assigned to digital input terminals. Depending upon the assignment states of those terminals, modifying the function code setting may cause a sudden motor start or an abrupt change in speed.
- When the inverter is controlled with the digital input signals, switching run or frequency command sources with the related terminal commands (e.g., *SS1*, *SS2*, *SS4*, *SS8*, *Hz2/Hz1*, *Hz/PID*, *IVS*, *LE* and *FMS*) may cause a sudden motor start or an abrupt change in speed.

An accident or physical injury may result.

Function code data		Terminal commands assigned	Symbol	Related function codes
Active ON	Active OFF			
0	1000	Select multistep frequency (0 to 15 steps)	<i>SS1</i>	C05 to C19
1	1001		<i>SS2</i>	
2	1002		<i>SS4</i>	
3	1003		<i>SS8</i>	
4	1004	Select ACC/DEC time (2 steps)	<i>RT1</i>	F07, F08, E10 to E15
5	1005	Select ACC/DEC time (4 steps)	<i>RT2</i>	
6	1006	Enable 3-wire operation	<i>HLD</i>	F02
7	1007	Coast to a stop	<i>BX</i>	—
8	1008	Reset alarm	<i>RST</i>	—
1009	9	Enable external alarm trip	<i>THR</i>	—
11	1011	Select frequency command 2/1	<i>Hz2/Hz1</i>	F01, C30
13	—	Enable DC braking	<i>DCBRK</i>	F20 to F22
14	1014	Select torque limiter level 2/1	<i>TL2/TL1</i>	F40, F41, E16, E17
15	—	Switch to commercial power (50 Hz)	<i>SW50</i>	—
16	—	Switch to commercial power (60 Hz)	<i>SW60</i>	—
17	1017	UP (Increase output frequency)	<i>UP</i>	Frequency setting: F01, C30
18	1018	DOWN (Decrease output frequency)	<i>DOWN</i>	PID command: J101, J201
19	1019	Enable data change with keypad	<i>WE-KP</i>	F00
20	1020	Cancel PID control	<i>Hz/PID</i>	J101 to J131 J201 to J231

Function code data		Terminal commands assigned	Symbol	Related function codes
Active ON	Active OFF			
21	1021	Switch normal/inverse operation	<i>IVS</i>	J101, J201
22	1022	Interlock	<i>IL</i>	F14
24	1024	Enable communications link via RS-485 or fieldbus (option)	<i>LE</i>	H30, y98
25	1025	Universal DI	<i>U-DI</i>	—
26	1026	Enable auto search for idling motor speed at starting	<i>STM</i>	H09
1030	30	Force to stop	<i>STOP</i>	F07, H56
33	1033	Reset PID integral and differential components	<i>PID-RST</i>	J101 to J131 J201 to J231
34	1034	Hold PID integral component	<i>PID-HLD</i>	
35	1035	Select local (keypad) operation	<i>LOC</i>	(See Section 5.5.4.)
38	1038	Enable run commands	<i>RE</i>	
39	—	Protect motor from dew condensation	<i>DWP</i>	J21
40	—	Enable integrated sequence to switch to commercial power (50 Hz)	<i>ISW50</i>	J22
41	—	Enable integrated sequence to switch to commercial power (60 Hz)	<i>ISW60</i>	
58	1058	Reset UP/DOWN frequency	<i>STZ</i>	F01, H61
72	1072	Count the run time of commercial power-driven motor 1	<i>CRUN-M1</i>	H44, H94
80	1080	Cancel customizable logic	<i>CLC</i>	E01 to E07 U81 to U87
81	1081	Clear all customizable logic timers	<i>CLTC</i>	
87	1087	Run command 2/1	<i>FR2/FR1</i>	
88	—	Run forward 2	<i>FWD2</i>	
89	—	Run reverse 2	<i>REV2</i>	
98	—	Run forward	<i>FWD</i>	F02
99	—	Run reverse	<i>REV</i>	F02
100	—	No function assigned	<i>NONE</i>	
131	1131	Flowrate switch	<i>FS</i>	J163 to J166
132	1132	Filter clogging reverse rotation command	<i>FRC</i>	J188 to J195
133	1133	Switch PID channel	<i>PID2/1</i>	J101, J201
134	—	Switch to fire mode	<i>FMS</i>	H116 to H121
171	1171	PID multistep command	<i>PID-SS1</i>	J136 to J138
172	1172	PID multistep command	<i>PID-SS2</i>	
181	1181	External PID multistep command	<i>EPID-SS1</i>	J550 to J553
182	1182	External PID multistep command	<i>EPID-SS2</i>	
190	1190	Cancel timer	<i>TMC</i>	T01 to T19
191	1191	Enable timer 1	<i>TM1</i>	T01 to T04
192	1192	Enable timer 2	<i>TM2</i>	T06 to T09
193	1193	Enable timer 3	<i>TM3</i>	T11 to T14
194	1194	Enable timer 4	<i>TM4</i>	T16 to T19

Function code data		Terminal commands assigned	Symbol	Related function codes
Active ON	Active OFF			
201	1201	External PID control 1 ON command	<i>EPID1-ON</i>	J501
202	1202	Cancel external PID control 1	<i>%/EPID1</i>	J501 to J540
203	1203	Switch normal/inverse operation under external PID control 1	<i>EPID1-IVS</i>	
204	1204	Reset external PID 1 integral and differential components	<i>EPID1-RST</i>	J501 to J540
205	1205	Hold external PID 1 integral component	<i>EPID1-HLD</i>	
211	1211	External PID control 2 ON command	<i>EPID2-ON</i>	J601
212	1212	Cancel external PID control 2	<i>%/EPID2</i>	J601 to J640
213	1213	Switch normal/inverse operation under external PID control 2	<i>EPID2-IVS</i>	
214	1214	Reset external PID 2 integral and differential components	<i>EPID2-RST</i>	J601 to J640
215	1215	Hold external PID 2 integral component	<i>EPID2-HLD</i>	
221	1221	External PID control 3 ON command	<i>EPID3-ON</i>	J651
222	1222	Cancel external PID control 3	<i>%/EPID3</i>	J651 to J690
223	1223	Switch normal/inverse operation under external PID control 3	<i>EPID3-IVS</i>	
224	1224	Reset external PID 3 integral and differential components	<i>EPID3-RST</i>	J651 to J690
225	1225	Hold external PID 3 integral component	<i>EPID3-HLD</i>	



Any negative logic (Active OFF) command cannot be assigned to the functions marked with "-" in the "Active OFF" column.

The "Enable external alarm trip" (data = 1009) and "Force to stop" (data = 1030) are fail-safe terminal commands. In the case of "Enable external alarm trip," when data = 1009, "Active ON" (alarm is triggered when ON); when data = 9, "Active OFF" (alarm is triggered when OFF).

Terminal function assignment and data setting

- Select multistep frequency (0 to 15 steps) -- **SS1**, **SS2**, **SS4**, and **SS8**
(Function code data = 0, 1, 2, and 3)

The combination of the ON/OFF states of digital input signals **SSI**, **SS2**, **SS4** and **SS8** selects one of 16 different frequency commands defined beforehand by 15 function codes C05 to C19 (Multistep frequency 0 to 15). With this, the inverter can drive the motor at 16 different preset frequencies.

Refer to C05 through C19.

- Select ACC/DEC time -- **RT1** and **RT2** (Function code data = 4 and 5)

These terminal commands switch between ACC/DEC time 1 to 4 (F07, F08 and E10 through E15).

Refer to F07 and F08.

- Enable 3-wire operation -- **HLD** (Function code data = 6)

Turning this terminal command ON self-holds the forward **FWD** or reverse **REV** run command, to enable 3-wire inverter operation.

Refer to F02.

- Coast to a stop -- **BX** (Function code data = 7)

Turning this terminal command ON immediately shuts down the inverter output so that the motor coasts to a stop, without issuing any alarms.

- Reset alarm -- **RST** (Function code data = 8)

Turning this terminal command ON clears the **ALM** state--alarm output (for any alarm). Turning it OFF erases the alarm display and clears the alarm hold state.

When you turn the **RST** command ON, keep it ON for 10 ms or more. This command should be kept OFF for the normal inverter operation.

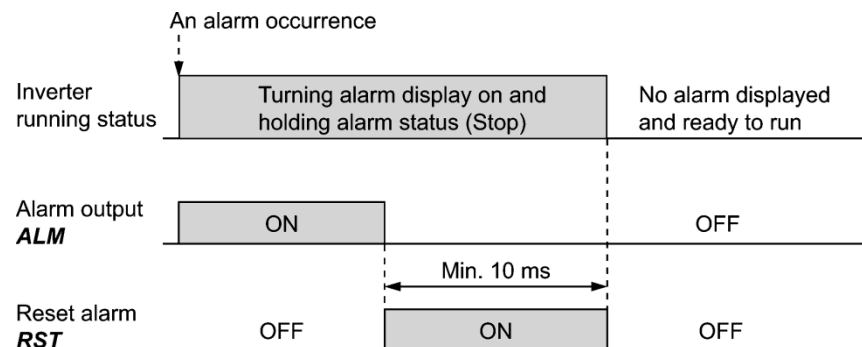

- Enable external alarm trip -- **THR** (Function code data = 9)

Turning this terminal command OFF immediately shuts down the inverter output (so that the motor coasts to a stop), displays the alarm **OH2**, and issues the alarm output (for any alarm) **ALM**. The **THR** command is self-held, and is reset when an alarm reset takes place.



Use this alarm trip command from external equipment when you have to immediately shut down the inverter output in the event of an abnormal situation in peripheral equipment.

■ Select frequency command 2/1 -- **H_{z2}/H_{z1}** (Function code data = 11)

Turning this terminal command ON and OFF switches the frequency command source between frequency command 1 (F01) and frequency command 2 (C30).

📖 Refer to F01.

■ Enable DC braking -- **DCBRK** (Function code data = 13)

This terminal command gives the inverter a DC braking command through the inverter's digital input.

(Requirements for DC braking must be satisfied.)

📖 Refer to F20 through F22.

■ Select torque limiter level 2/1 -- **TL₂/TL₁** (Function code data = 14)

This terminal command switches between torque limiter 1 (F40 and F41) and torque limiter 2 (E16 and E17).

📖 Refer to F40 and F41.

■ Switch to commercial power for 50 Hz or 60 Hz -- **SW50** and **SW60**
(Function code data = 15 and 16)

When an external sequence switches the motor drive power from the commercial line to the inverter, the terminal command **SW50** or **SW60** enables the inverter to start running the motor with the current commercial power frequency, regardless of settings of the reference/output frequency in the inverter. A running motor driven by commercial power is carried on into inverter operation. This command helps you smoothly switch the motor drive power source from the commercial power to the inverter.

For details, refer to the table below, the operation scheme and an example of external sequence and its operation time scheme on the following pages.

Assignment	The inverter:	Description
SW50	Starts at 50 Hz.	 Note Do not concurrently assign both SW50 and SW60 .
SW60	Starts at 60 Hz.	

Operation Schemes

- When the motor speed remains almost the same during coast-to-stop:

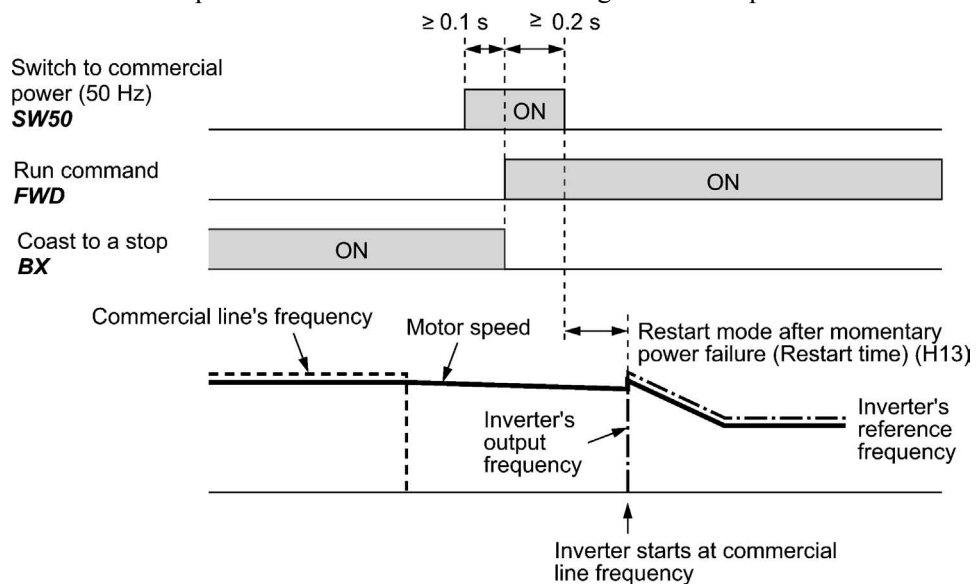

- When the motor speed decreases significantly during coast-to-stop (with the current limiter activated):

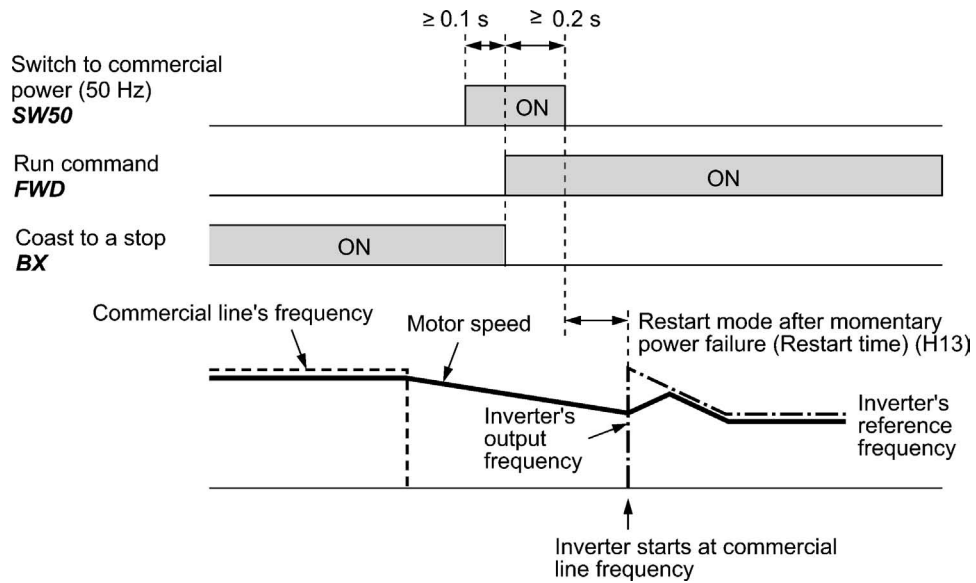

- Note**
- Secure more than 0.1 second after turning ON the "Switch to commercial power" signal before turning ON a run command.
 - Secure more than 0.2 second of an overlapping period with both the "Switch to commercial power" signal and run command being ON.
 - If an alarm has been issued or **BX** has been ON when the motor drive source is switched from the commercial power to the inverter, the inverter will not be started at the commercial power frequency and will remain OFF. After the alarm has been reset or **BX** turned OFF, operation at the frequency of the commercial power will not be continued, and the inverter will be started at the ordinary starting frequency.
- If you wish to switch the motor drive source from the commercial line to the inverter, be sure to turn **BX** OFF before the "Switch to commercial power" signal is turned OFF.
- When switching the motor drive source from the inverter to commercial power, adjust the inverter's reference frequency at or slightly higher than that of the commercial power frequency beforehand, taking into consideration the motor speed down during the coast-to-stop period produced by switching.
 - Note that when the motor drive source is switched from the inverter to the commercial power, a high inrush current will be generated, because the phase of the commercial power usually does not match the motor speed at the switching. Make sure that the power supply and all the peripheral equipment are capable of withstanding this inrush current.
 - If you have enabled "Restart after momentary power failure" (F14 = 3, 4, or 5), keep **BX** ON during commercial power driven operation to prevent the inverter from restarting after a momentary power failure.

Example of Sequence Circuit

Main power supply

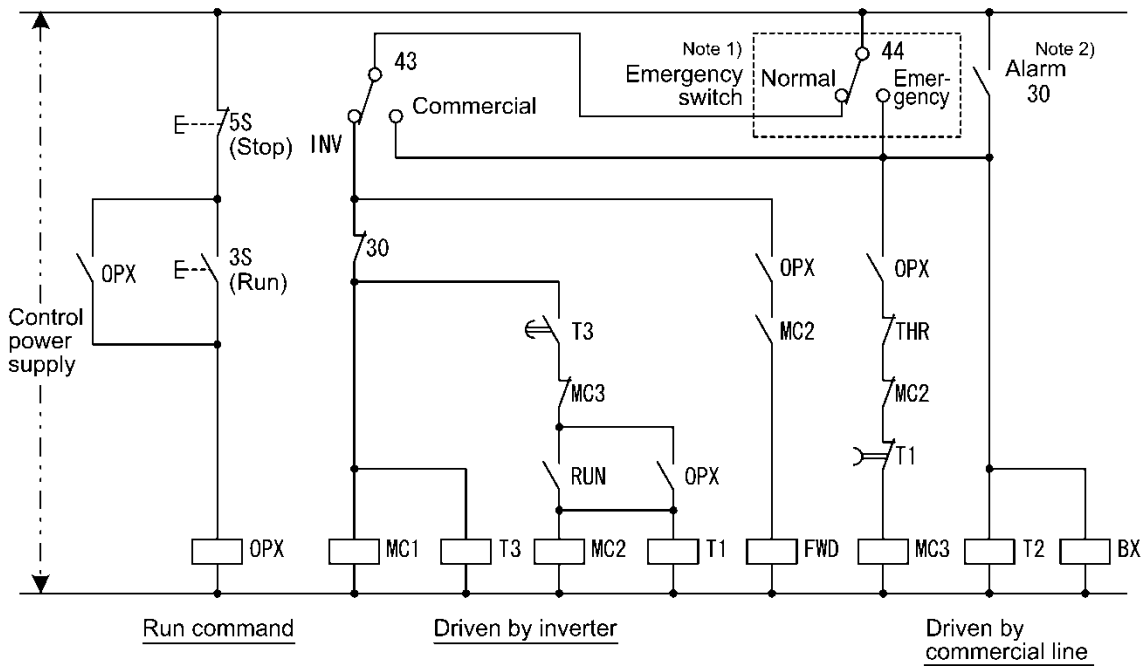
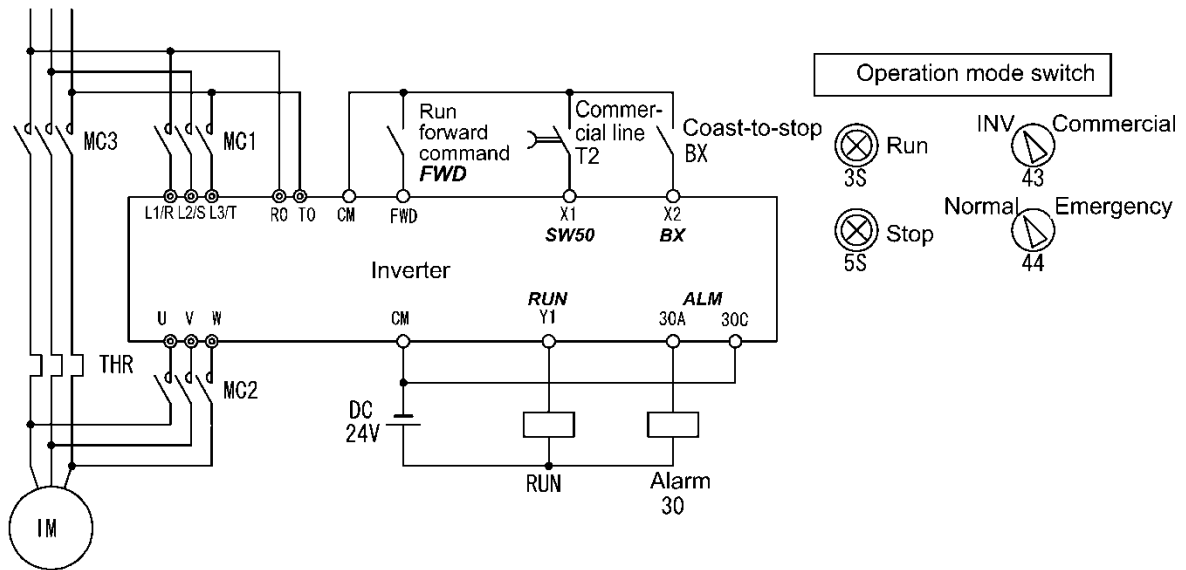

Note 1) Emergency switch

Manual switch provided for the event that the motor drive source cannot be switched normally to the commercial power due to a serious problem of the inverter

Note 2) When any alarm has occurred inside the inverter, the motor drive source will automatically be switched to the commercial power.

Example of Operation Time Scheme

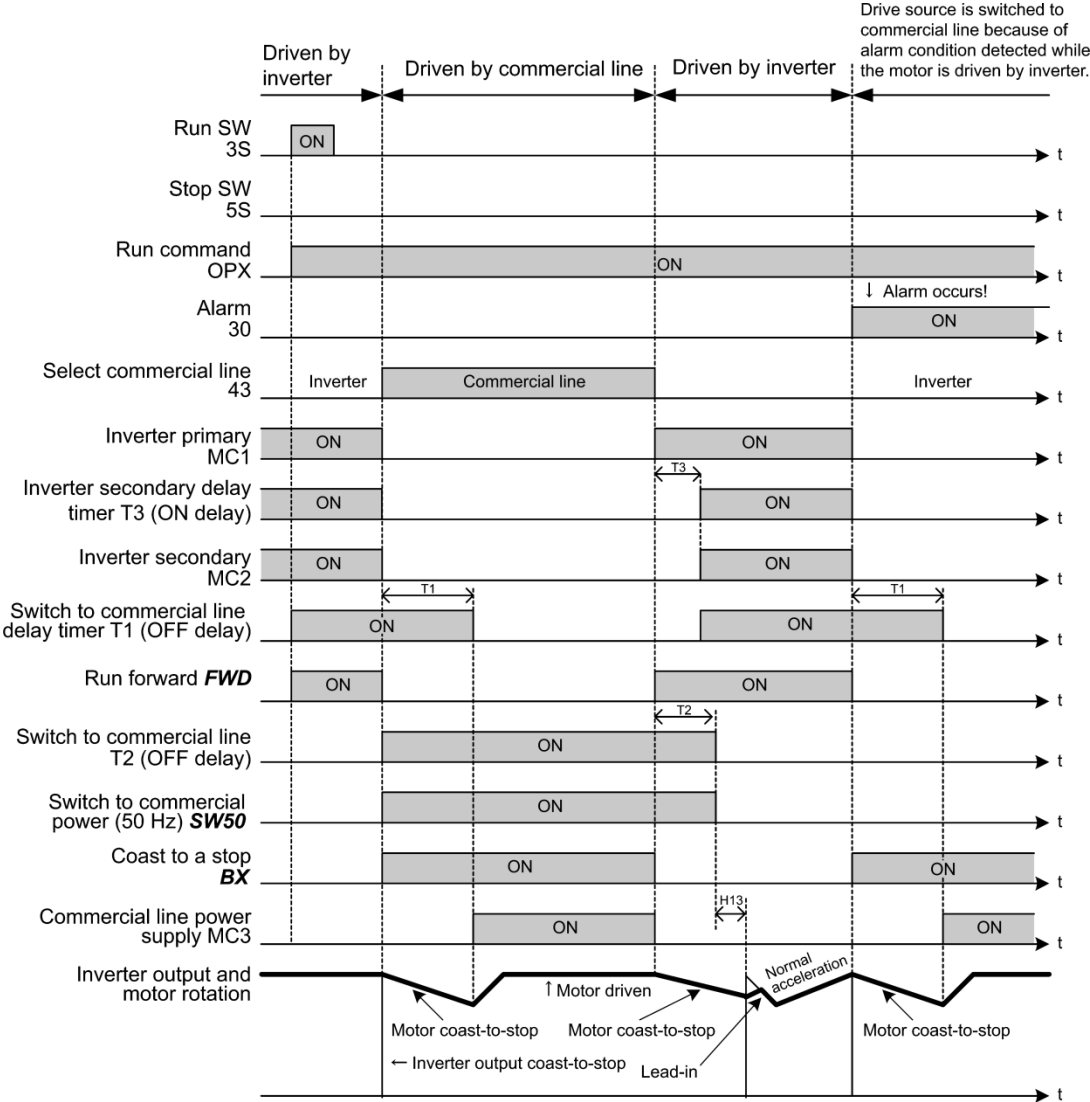

Tip Alternatively, you may use the integrated sequence by which some of the actions above are automatically performed by the inverter itself. For details, refer to the description of *ISW50* and *ISW60*.

- UP (Increase output frequency) and DOWN (Decrease output frequency) commands -- **UP** and **DOWN** (Function code data = 17 and 18)
 - Frequency setting

Turning the terminal command **UP** or **DOWN** ON causes the output frequency to increase or decrease, respectively, within the range from 0 Hz to the maximum frequency.

Refer to F01 (data = 7).
 - PID command

Turning the terminal command **UP** or **DOWN** ON causes the PID command value to increase or decrease, respectively, within the range from 0 to 100%.

Refer to J102 (data = 3).

■ Enable data change with keypad -- **WE-KP** (Function code data = 19)

Turning the terminal command **WE-KP** OFF protects function code data from accidentally getting changed by pressing the keys on the keypad.

Only when this terminal command is ON, you can change function code data from the keypad.

Refer to F00.

■ Cancel PID control -- **Hz/PID** (Function code data = 20)

Turning this terminal command ON disables PID control.

If the PID control is disabled with this command, the inverter runs the motor with the reference frequency manually set by any of the multistep frequency, keypad, analog input, etc.

Terminal command Hz/PID	Function
OFF	Enable PID control
ON	Disable PID control/Enable manual settings

Refer to J101 through J131 and J201 through J231.

■ Switch normal/inverse operation -- **IVS** (Function code data = 21)

This terminal command switches the output frequency control between normal (proportional to the input value) and inverse in analog frequency setting or under PID process control. To select the inverse operation, turn the **IVS** ON.

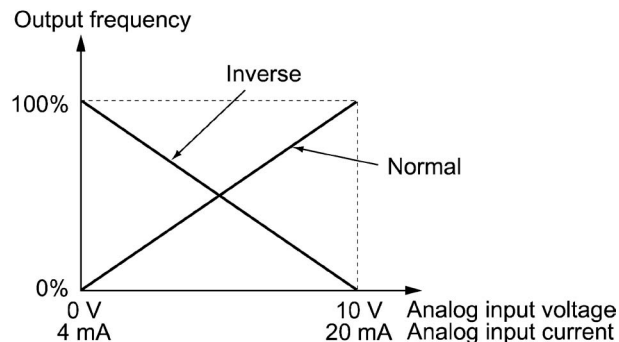

Tip The normal/inverse switching operation is useful for air-conditioners that require switching between cooling and heating. In cooling, the speed of the fan motor (output frequency of the inverter) is increased to lower the temperature. In heating, it is reduced to lower the temperature. This switching is realized by the **IVS**.

- When the inverter is driven by an external analog frequency command sources (terminals [12], [C1] and [V2]):

Switching normal/inverse operation can apply only to the analog frequency command sources (terminals [12], [C1] and [V2]) in frequency command 1 (F01) and does not affect frequency command 2 (C30) or UP/DOWN control.

As listed below, the combination of the "Selection of normal/inverse operation for frequency command 1" (C53) and the terminal command **IVS** determines the final operation.

Combination of C53 and **IVS**

Data for C53	IVS	Final operation
0: Normal operation	OFF	Normal
	ON	Inverse
1: Inverse operation	OFF	Inverse
	ON	Normal

- When process control is performed by the PID processor integrated in the inverter:

The terminal command **Hz/PID** ("Cancel PID control") can switch PID control between enabled (process is to be controlled by the PID processor) and disabled (process is to be controlled by the manual frequency setting). In either case, the combination of the "PID control" (J101, J201) or "Selection of normal/inverse operation for frequency command 1" (C53) and the terminal command **IVS** determines the final operation as listed below.

When PID control is enabled:

The normal/inverse operation selection for the PID processor output (reference frequency) is as follows.

PID control (Mode selection) (J101, J201)	IVS	Final operation
1: Enable (normal operation)	OFF	Normal
	ON	Inverse
2: Enable (inverse operation)	OFF	Inverse
	ON	Normal

When PID control is disabled:

The normal/inverse operation selection for the manual reference frequency is as follows.

Selection of normal/inverse operation for frequency command 1 (C53)	IVS	Final operation
0: Normal operation	–	Normal
1: Inverse operation	–	Inverse



When process control is performed by the PID control facility integrated in the inverter, the **IVS** is used to switch the PID processor output (reference frequency) between normal and inverse, and has no effect on any normal/inverse operation selection of the manual frequency setting.

Refer to the descriptions of J101 through J138 and J201 through J231.

■ Interlock -- **IL** (Function code data = 22)

In a configuration where a magnetic contactor (MC) is installed in the power output (secondary) circuit of the inverter, the momentary power failure detection feature provided inside the inverter may not be able to accurately detect a momentary power failure by itself. Using a digital signal input with the interlock command **IL** assures the accurate detection.

Refer to F14.

Terminal command IL	Meaning
OFF	No momentary power failure has occurred.
ON	A momentary power failure has occurred. (Restart after a momentary power failure enabled)

■ Enable communications link via RS-485 or fieldbus (option)

-- **LE** (Function code data = 24)

Turning this terminal command ON gives priorities to frequency commands or run commands received via the RS-485 communications link (H30) or the fieldbus option (y98).

No **LE** assignment is functionally equivalent to the **LE** being ON.

Refer to H30 (Communications link function) and y98 (Bus link function).

■ Universal DI -- **U-DI** (Function code data = 25)

Using **U-DI** enables the inverter to monitor digital signals sent from the peripheral equipment via an RS-485 communications link or a fieldbus option by feeding those signals to the digital input terminals. Signals assigned to the universal DI are simply monitored and do not operate the inverter.

📖 For an access to universal DI via the RS-485 or fieldbus communications link, refer to their respective Instruction Manuals.

■ Enable auto search for idling motor speed at starting -- **STM** (Function code data = 26)

This digital terminal command determines, at the start of operation, whether or not to search for idling motor speed and follow it.

📖 Refer to H09 (Starting mode).

■ Force to stop -- **STOP** (Function code data = 30)

Turning this terminal command OFF causes the motor to decelerate to a stop in accordance with the H56 data (Deceleration time for forced stop). After the motor stops, the inverter enters the alarm state with the alarm **Er6** displayed.

📖 Refer to F07.

■ Reset PID integral and differential components -- **PID-RST** (Function code data = 33)

Turning this terminal command ON resets the integral and differential components of the PID processor.

📖 Refer to J101 through J131 and J201 through J231.

■ Hold PID integral component -- **PID-HLD** (Function code data = 34)

Turning this terminal command ON holds the integral components of the PID processor.

📖 Refer to J101 through J131 and J201 through J231.

■ Select local (keypad) operation -- **LOC** (Function code data = 35)

This terminal command switches the sources of run and frequency commands between remote and local.

📖 For details of switching between remote and local modes, refer to Chapter 5, Section 5.5.4 "Remote and local modes."

■ Enable run commands -- **RE** (Function code data = 38)

Once this terminal command is assigned to any digital input terminal, the inverter no longer starts running with a run command only. Upon receipt of a run command, the inverter gets ready to run and outputs an **AX2** signal ("Run command entered").

Entering an **RE** signal ("Enable run commands") when the inverter is ready for running starts the inverter to run.

Input		Output	Inverter status
Run command (e.g., FWD)	Enable run commands RE	Run command entered AX2	
OFF	OFF	OFF	Stopped
OFF	ON	OFF	Stopped
ON	OFF	ON	Stopped
ON	ON	ON	Running

Typical operation sequence of **RE**

- (1) A run command **FWD** is given to the inverter.
- (2) When the inverter gets ready for running, it outputs an **AX2** signal ("Run command entered").
- (3) Upon receipt of the **AX2**, the upper equipment gets ready to operate the peripherals (e.g., opening a damper).
- (4) Upon completion of preparation of the peripherals, the upper equipment gives an **RE** signal ("Enable run command") to the inverter.
- (5) Upon receipt of the **RE**, the inverter starts running.

■ Protect motor from dew condensation -- **DWP** (Function code data = 39)

Turning this terminal command ON supplies a DC current to the motor in a stopped state in order to generate heat, preventing dew condensation.

📖 Refer to J21.

■ Enable integrated sequence to switch to commercial power for 50 Hz and 60 Hz -- **ISW50** and **ISW60** (Function code data = 40 and 41)

With the terminal command **ISW50** or **ISW60** assigned, the inverter controls the magnetic contactor that switches the motor drive source between the commercial power and the inverter output according to the integrated sequence.

This control is effective when not only **ISW50** or **ISW60*** has been assigned to the input terminal but also the **SW88** and **SW52-2** signals have been assigned to the output terminals. (It is not essential to assign the **SW52-1** signal.)

* The **ISW50** or **ISW60** should be selected depending upon the frequency of the commercial power; the former for 50 Hz and the latter for 60 Hz.

📖 For details about **SW88** and **SW52-2** ("Switch motor drive source between commercial power and inverter output"), refer to E20 to E27.

For details of these commands, refer to the circuit diagrams and timing schemes on the following pages.

Terminal command assigned	Operation (Switching from commercial power to inverter)
ISW50 Enable integrated sequence to switch to commercial power (50 Hz)	Start at 50 Hz.
ISW60 Enable integrated sequence to switch to commercial power (60 Hz)	Start at 60 Hz.

 **Note** Do not assign both **ISW50** and **ISW60** at the same time. Doing so cannot guarantee the result.

Circuit Diagram and Configuration

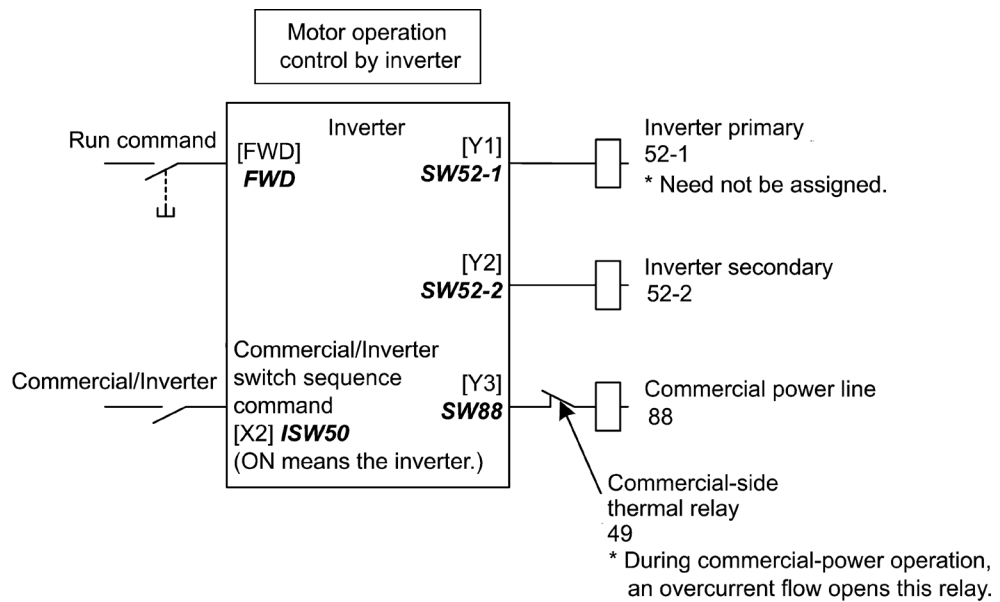
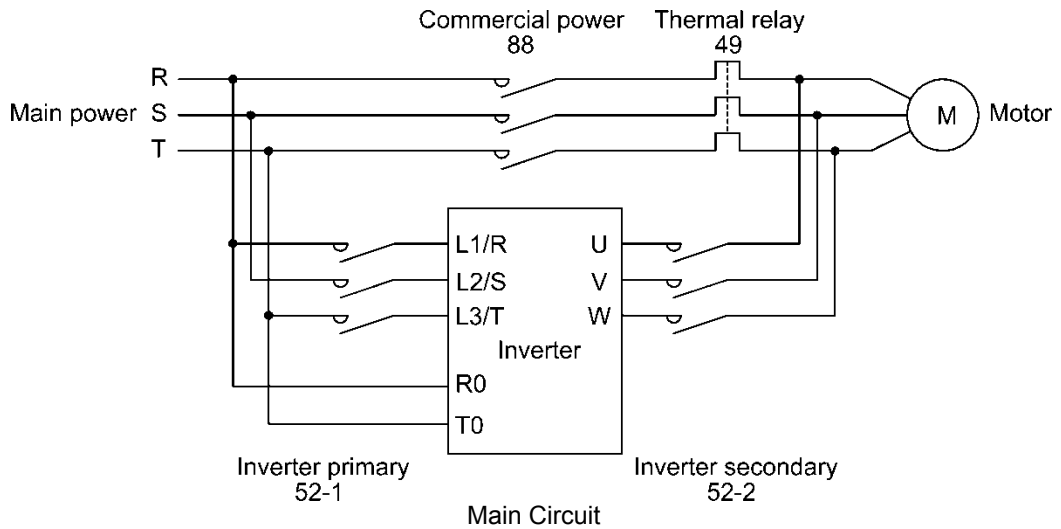

Configuration of Control Circuit

Summary of Operation

Input		Output (Status signal and magnetic contactor)			Inverter operation
<i>ISW50</i> or <i>ISW60</i>	Run command	<i>SW52-1</i> 52-1	<i>SW52-2</i> 52-2	<i>SW88</i> 88	
OFF (Commercial power)	ON	OFF	OFF	ON	OFF
	OFF			OFF	
ON (Inverter)	ON	ON	ON	OFF	ON
	OFF			OFF	

Timing Scheme

Switching from inverter operation to commercial-power operation

ISW50/ISW60: ON → OFF

- (1) The inverter output is shut OFF immediately (Power gate IGBT OFF)
- (2) The inverter primary circuit **SW52-1** and the inverter secondary side **SW52-2** are turned OFF immediately.
- (3) If a run command is present after an elapse of t1 (0.2 sec + time specified by H13), the commercial power circuit **SW88** is turned ON.

Switching from commercial-power operation to inverter operation

ISW50/ISW60: OFF → ON

- (1) The inverter primary circuit **SW52-1** is turned ON immediately.
- (2) The commercial power circuit **SW88** is turned OFF immediately.
- (3) After an elapse of t2 (0.2 sec + time required for the main circuit to get ready) from when **SW52-1** is turned ON, the inverter secondary circuit **SW52-2** is turned ON.
- (4) After an elapse of t3 (0.2 sec + time specified by H13) from when **SW52-2** is turned ON, the inverter harmonizes once the motor that has been freed from the commercial power to the commercial power frequency. Then the motor returns to the operation driven by the inverter.

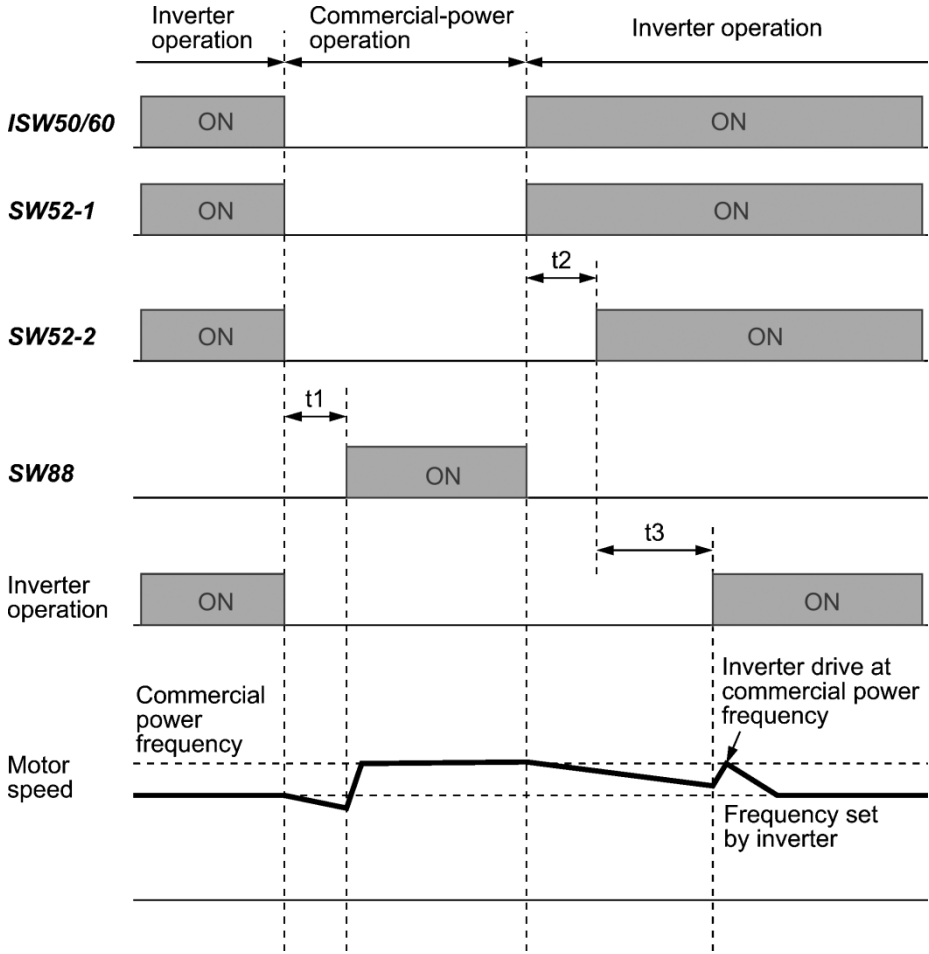

- t1: 0.2 sec + Time specified by H13 (Restart mode after momentary power failure)
- t2: 0.2 sec + Time required for the main circuit to get ready
- t3: 0.2 sec + Time specified by H13 (Restart mode after momentary power failure)

Selection of Commercial Power Switching Sequence

J22 specifies whether or not to automatically switch to commercial-power operation when an inverter alarm occurs.

Data for J22	Sequence (upon occurrence of an alarm)
0	Keep inverter-operation (Stop due to alarm.)
1	Automatically switch to commercial-power operation

- Note**
- The sequence operates normally also even when **SW52-1** is not used and the main power of the inverter is supplied at all times.
 - Using **SW52-1** requires connecting the input terminals [R0] and [T0] for an auxiliary control power. Without the connection, turning **SW52-1** OFF loses also the control power.
 - The sequence operates normally even if an alarm occurs in the inverter except when the inverter itself is broken. Therefore, for a critical facility, be sure to install an emergency switching circuit outside the inverter.
 - Turning ON both the magnetic contactor MC (88) at the commercial-power side and the MC (52-2) at the inverter output side at the same time supplies main power mistakenly from the output (secondary) side of the inverter, which may damage the inverter. To prevent it, be sure to set up an interlocking logic outside the inverter.

Examples of Sequence Circuits

1) Standard sequence

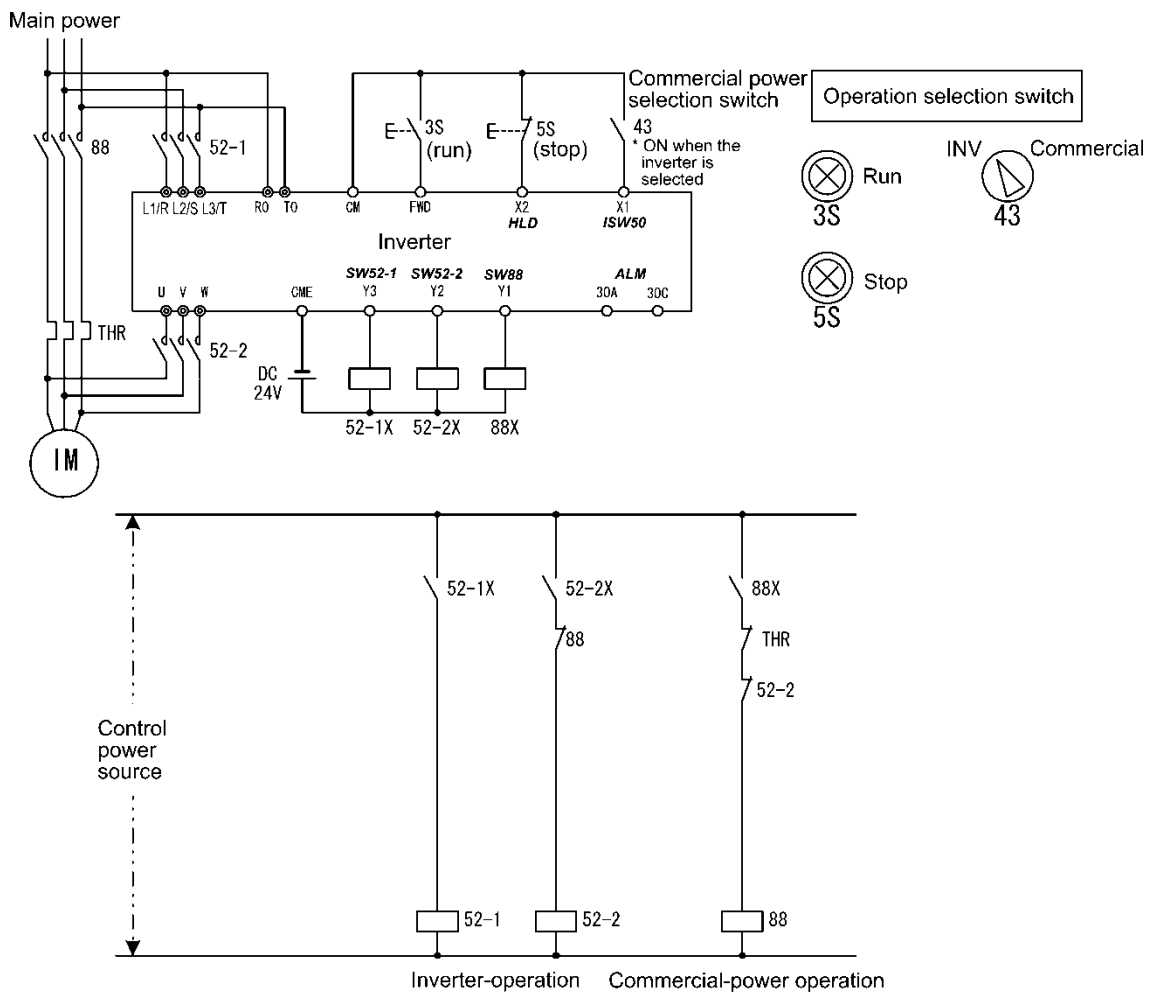

2) Sequence with an emergency switching function

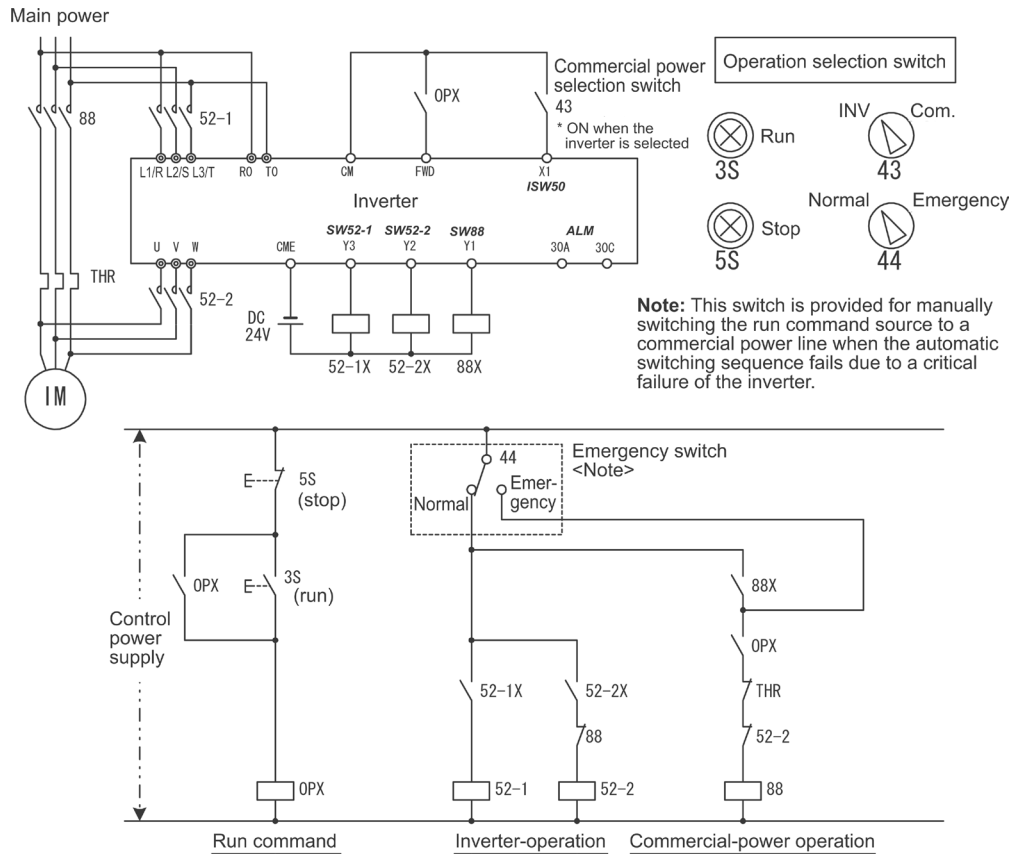

3) Sequence with an emergency switching function --Part 2 (Automatic switching by the alarm output issued by the inverter)

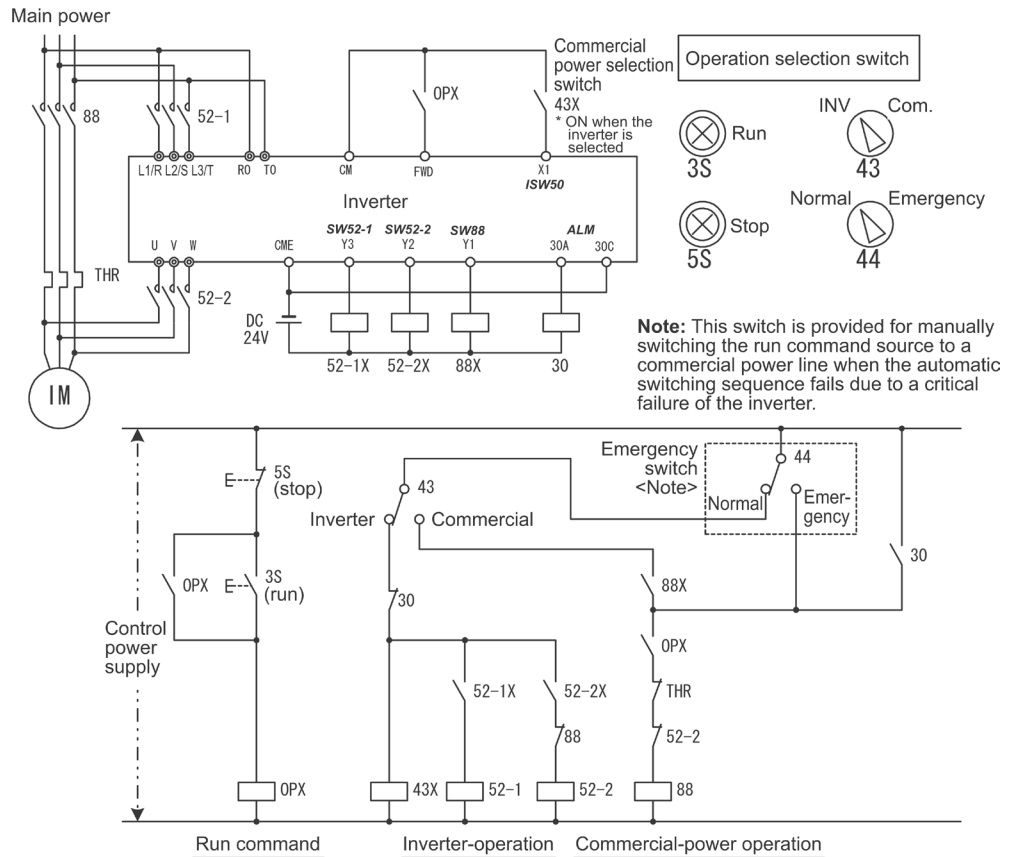

■ Reset UP/DOWN frequency -- **STZ** (Function code data = 58)

Turning the **STZ** ON clears the frequency increase or decrease from the "Multistep frequency + UP/DOWN control." (This command merely clears the increase or decrease so that the reference frequency may not come to be 0 Hz.)

Refer to F01 and H61.

■ Count the run time of commercial power-driven motor 1 -- **CRUN-M1** (Function code data = 72)

The **CRUN-M1** enables the inverter to count the cumulative run time of motor 1 even when it is driven by commercial power (not by the inverter).

When the **CRUN-M1** is ON, the inverter judges that motor 1 is driven by commercial power and counts the run time of the motor.

■ Cancel customizable logic -- **CLC** (E01 to E07, data = 80)

The **CLC** disables the customizable logic temporarily. Use it to run the inverter without using the customizable logic circuit or timers for maintenance or other purposes.

CLC	Function
OFF	Enable customizable logic (Depends on the U00 setting)
ON	Disable customizable logic

Note Before changing the setting of **CLC**, ensure safety. Turning **CLC** ON disables the sequence of the customizable logic, causing a sudden motor start depending upon the settings.

■ Clear all customizable logic timers -- **CLTC** (E01 to E07, data = 81)

Assigning **CLTC** to any of the general-purpose digital input terminals and turning it ON resets all of the general-purpose timers and counters in the customizable logic. Use this command when the timings between the external sequence and the internal customizable logic do not match due to a momentary power failure or other reasons so that resetting and restarting the system is required.

CLTC	Function
OFF	Ordinary operation
ON	Reset all of the general-purpose timers and counters in the customizable logic. (To operate the timers and counters again, revert CLTC to OFF.)

■ Run command 2/1 -- **FR2/FR1** (Function code data = 87)

The **FR2/FR1** switches between the run command source selected by Run command (**FWD** and **REV**) and the one selected by Run command 2 (**FWD2** and **REV2**).

■ Run forward 2 -- **FWD2** (Function code data = 88)

Turning the **FWD2** ON runs the motor in the forward direction; turning it OFF decelerates it to a stop.

 Tip The **FWD2** can be assigned by any of E01 to E07, E98 and E99.

■ Run reverse 2 -- **REV2** (Function code data = 89)

Turning the **REV2** ON runs the motor in the reverse direction; turning it OFF decelerates it to a stop.

 Tip The **REV2** can be assigned by any of E01 to E07, E98 and E99.

■ Run forward -- **FWD** (Function code data = 98)

Turning the **FWD** ON runs the motor in the forward direction; turning it OFF decelerates it to a stop.

 Tip The **FWD** can be assigned by E98 or E99 only.

■ Run reverse -- **REV** (Function code data = 99)

Turning the **REV** ON runs the motor in the reverse direction; turning it OFF decelerates it to a stop.

 Tip The **REV** can be assigned by E98 or E99 only.

■ No function assigned (Function code data = 100)

Use this when no function is to be assigned to general-purpose, digital input terminals or the customizable logic function disables terminal functions.

■ Flowrate switch -- **FS** (Function code data = 131)

Turning the **FS** ON uses the flowrate sensor as a flowrate switch for detecting the dry pump or the end of curve.

 Refer to J163 through J166.

■ Filter clogging reverse rotation command -- **FRC** (Function code data = 132)

Turning the **FRC** ON activates the filter clogging prevention to run the motor in the forward and reverse directions repeatedly according to the reverse rotation running time (J194).

 Refer to J188 through J196.

■ Switch PID channel -- **PID2/1** (Function code data = 133)

The **PID2/1** switches between PID control 1 (J101 through J131) and PID control 2 (J201 through J231).

 Refer to J101 through J131 and J201 through J231.

■ Switch to fire mode -- **FMS** (Function code data = 134)

Turning the **FMS** this terminal command ON switches to the fire mode to be used in an emergency, in which the inverter runs the motor at the predetermined speed.

 Refer to H116 through H121.

- PID multistep command
-- **PID-SS1**, **PID-SS2** (Function code data = 171, 172)

Turning the **PID-SS1** and **PID-SS2** ON/OFF selectively switches the PID multistep commands (preset by J136 through J138) in three steps. This command is available for both PID control 1 and PID control 2.

Refer to J136 through J138.

- External PID multistep command
-- **EPID-SS1**, **EPID-SS2** (Function code data = 181, 182)

Turning the **EPID-SS1** and **EPID-SS2** ON/OFF selectively switches the external PID multistep commands (preset by J551 through J553) in three steps.

Refer to J550 through J553.

- Cancel timer -- **TMC** (Function code data = 190)

Turning the **TMC** ON cancels timer operation.

Refer to T01 through T19.

- Enable timer 1 to 4 -- **TM1** to **TM4** (Function code data = 191 to 194)

Turning the **TM1** to **TM4** ON/OFF selectively enables timers 1 to 4, as listed below..

Refer to T01 through T19.

<i>External input signal status</i>				<i>Timers selected</i>
<i>TM1</i>	<i>TM2</i>	<i>TM3</i>	<i>TM4</i>	
<i>OFF</i>	<i>OFF</i>	<i>OFF</i>	<i>OFF</i>	
<i>ON</i>	<i>OFF</i>	<i>OFF</i>	<i>OFF</i>	<i>Timer 1</i>
<i>OFF</i>	<i>ON</i>	<i>OFF</i>	<i>OFF</i>	<i>Timer 2</i>
<i>OFF</i>	<i>OFF</i>	<i>ON</i>	<i>OFF</i>	<i>Timer 3</i>
<i>OFF</i>	<i>OFF</i>	<i>OFF</i>	<i>ON</i>	<i>Timer 4</i>
<i>ON</i>	<i>ON</i>	<i>OFF</i>	<i>OFF</i>	<i>Timers 1 + 2</i>
<i>ON</i>	<i>OFF</i>	<i>ON</i>	<i>OFF</i>	<i>Timers 1 + 3</i>
<i>ON</i>	<i>OFF</i>	<i>OFF</i>	<i>ON</i>	<i>Timers 1 + 4</i>
<i>OFF</i>	<i>ON</i>	<i>ON</i>	<i>OFF</i>	<i>Timers 2 + 3</i>
<i>OFF</i>	<i>ON</i>	<i>OFF</i>	<i>ON</i>	<i>Timers 2 + 4</i>
<i>OFF</i>	<i>OFF</i>	<i>ON</i>	<i>ON</i>	<i>Timers 3 + 4</i>
<i>ON</i>	<i>ON</i>	<i>ON</i>	<i>OFF</i>	<i>Timers 1 + 2 + 3</i>
<i>ON</i>	<i>ON</i>	<i>OFF</i>	<i>ON</i>	<i>Timers 1 + 2 + 4</i>
<i>ON</i>	<i>OFF</i>	<i>ON</i>	<i>ON</i>	<i>Timers 1 + 3 + 4</i>
<i>OFF</i>	<i>ON</i>	<i>ON</i>	<i>ON</i>	<i>Timers 2 + 3 + 4</i>
<i>ON</i>	<i>ON</i>	<i>ON</i>	<i>ON</i>	<i>Timers 1 + 2 + 3 + 4</i>

- External PID control 1 ON command -- **EPID1-ON** (Function code data = 201)

Turning the **EPID1-ON** ON enables external PID control 1.

Refer to J501.

- Cancel external PID control 1 -- **%/EPID1** (Function code data = 202)

Turning the **%/EPID1** ON switches from external PID control 1 to manual commands (running at the frequency selected from the keypad or analog input).

Terminal command %/EPID1	Function
OFF	Enable external PID control 1
ON	Disable external PID control 1 (Enable manual commands)

Refer to J540.

- Switch normal/inverse operation under external PID control 1
-- **EPID1-IVS** (Function code data = 203)

The **EPID1-IVS** switches the output signal of external PID control 1 between normal and inverse operations.

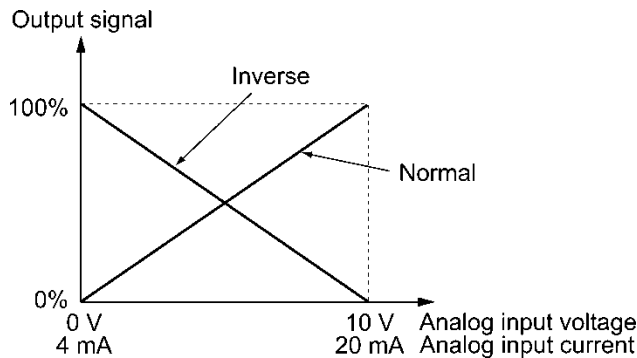

- Reset external PID1 integral and differential components
-- **EPID1-RST** (Function code data = 204)

Turning the **EPID1-RST** ON resets the integral and differential terms of the PID processor of external PID control 1.

Refer to J501 through J540.

- Hold external PID1 integral component -- **EPID1-HLD** (Function code data = 205)

When the **EPID1-HLD** is ON, the inverter holds the integral term of the PID processor of external PID control 1.

Refer to J501 through J540.

- External PID control 2 ON command -- **EPID2-ON** (Function code data = 211)

Turning the **EPID2-ON** ON enables external PID control 2.

Refer to J601.

■ Cancel external PID control 2 -- **%/EPID2** (Function code data = 212)

Turning the **%/EPID2** ON switches from external PID control 2 to manual commands (running at the frequency selected from the keypad, analog input, or PID control 1).

Terminal command %/EPID2	Function
OFF	Enable External PID control 2
ON	Disable External PID control 2 (Enable manual frequency settings)

Refer to J601 to J640.

■ Switch normal/inverse operation under external PID control 2
-- **EPID2-IVS** (Function code data = 213)

The **EPID2-IVS** switches the output signal of external PID control 2 between normal and inverse operations.

■ Reset external PID2 integral and differential components
-- **EPID2-RST** (Function code data = 214)

Turning the **EPID2-RST** ON resets the integral and differential terms of the PID processor of external PID control 2.

Refer to J601 through J640.

■ Hold external PID2 integral component -- **EPID2-HLD** (Function code data = 215)

When the **EPID2-HLD** is ON, the inverter holds the integral term of the PID processor of external PID control 1.

Refer to J601 through J640.

■ External PID control 3 ON command -- **EPID3-ON** (Function code data = 221)

Turning the **EPID3-ON** ON enables external PID control 3.

Refer to J651.

■ Cancel external PID control 3 -- **%/EPID3** (Function code data = 222)

Turning the **%/EPID3** ON switches from external PID control 3 to manual commands (running at the frequency selected from the keypad, analog input, PID control 1 or 2).

Terminal command %/EPID3	Function
OFF	Enable External PID control 3
ON	Disable External PID control 3 (Enable manual frequency settings)

Refer to J651 to J690.

■ Switch normal/inverse operation under external PID control 3
-- **EPID3-IVS** (Function code data = 223)

The **EPID3-IVS** switches the output signal of external PID control 3 between normal and inverse operations.

- Reset external PID3 integral and differential components
-- **EPID3-RST** (Function code data = 224)

Turning the **EPID3-RST** ON resets the integral and differential terms of the PID processor of external PID control 3.

📖 Refer to J651 through J690.

- Hold external PID3 integral component -- **EPID3-HLD** (Function code data = 225)

When the **EPID3-HLD** is ON, the inverter holds the integral term of the PID processor of external PID control 3.

📖 Refer to J651 through J690.

E10 to E15	Acceleration Time 2 to 4, Deceleration Time 2 to 4	(Refer to F07)
-------------------	---	-----------------------

Refer to the description of F07.

E16, E17	Torque Limiter 2	(Refer to F40.)
-----------------	-------------------------	------------------------

Refer to the description of F40.

E20 through E24 and E27 assign output signals (listed on the following pages) to general-purpose, programmable output terminals, [Y1] to [Y4], [Y5A/C] and [30A/B/C].

These function codes can also switch the logic system between normal and negative to define how the inverter interprets the ON or OFF state of each terminal. The factory default setting is normal logic system "Active ON."

Terminals [Y1] to [Y4] are transistor outputs and terminals [Y5A/C] and [30A/B/C] are relay contact outputs. In normal logic, if an alarm occurs, the relay will be energized so that [30A] and [30C] will be closed, and [30B] and [30C] opened. In negative logic, the relay will be deenergized so that [30A] and [30C] will be opened, and [30B] and [30C] closed. This may be useful for the implementation of failsafe power systems.

-  Note
- When negative logic is employed, all output signals are active (e.g. an alarm would be recognized) while the inverter is powered OFF. To avoid causing system malfunctions by this, interlock these signals to keep them ON using an external power supply. Furthermore, the validity of these output signals is not guaranteed for approximately 1.5 seconds (for 30 HP or below) or 3 seconds (for 40 HP or above) after power-ON, so introduce such a mechanism that masks them during the transient period.
 - Terminals [Y5A/C] and [30A/B/C] use mechanical contacts that cannot stand frequent ON/OFF switching. Where frequent ON/OFF switching is anticipated (for example, limiting a current by using signals subjected to inverter output limit control such as switching to commercial power line or direct-on-line starting), use transistor outputs [Y1], [Y2], [Y3] and [Y4] instead. The service life of a relay is approximately 200,000 times if it is switched ON and OFF at one-second intervals.

The tables given on the following pages list functions that can be assigned to terminals [Y1] to [Y4], [Y5A/C], and [30A/B/C].

The descriptions are, in principle, arranged in the numerical order of assigned data. However, highly relevant signals are collectively described where one of them first appears. Refer to the function codes or signals in the "Related function codes/signals (data)" column, if any.

Explanations of each function are given in normal logic system "Active ON."

Function code data		Functions assigned	Symbol	Related function codes/signals (data)
Active ON	Active OFF			
0	1000	Inverter running	<i>RUN</i>	—
1	1001	Frequency (speed) arrival signal	<i>FAR</i>	E30
2	1002	Frequency (speed) detected	<i>FDT</i>	E31, E32
3	1003	Undervoltage detected (Inverter stopped)	<i>LU</i>	—
5	1005	Inverter output limiting	<i>IOL</i>	—
6	1006	Auto-restarting after momentary power failure	<i>IPF</i>	F14
7	1007	Motor overload early warning	<i>OL</i>	E34, F10, F12
10	1010	Inverter ready to run	<i>RDY</i>	—
11	—	Switch motor drive source between commercial power and inverter output (For MC on commercial line)	<i>SW88</i>	E01 to E07 <i>ISW50</i> (40) <i>ISW60</i> (41) J22
12	—	Switch motor drive source between commercial power and inverter output (For secondary side)	<i>SW52-2</i>	
13	—	Switch motor drive source between commercial power and inverter output (For primary side)	<i>SW52-1</i>	
15	1015	Select AX terminal function (For MC on primary side)	<i>AX</i>	—
16	1016	Shifted to pattern operation stage	<i>TU</i>	C21 to C28
17	1017	Pattern operation cycle completed	<i>TO</i>	
18	1018	Pattern operation stage number	<i>STG1</i>	
19	1019	Pattern operation stage number	<i>STG2</i>	
20	1020	Pattern operation stage number	<i>STG4</i>	
22	1022	Inverter output limiting with delay	<i>IOL2</i>	<i>IOL</i> (5)
25	1025	Cooling fan in operation	<i>FAN</i>	H06
26	1026	Auto-resetting	<i>TRY</i>	H04, H05
27	1027	Universal DO	<i>U-DO</i>	—
28	1028	Heat sink overheat early warning	<i>OH</i>	—
30	1030	Lifetime alarm	<i>LIFE</i>	H42
33	1033	Reference loss detected	<i>REF OFF</i>	E65
35	1035	Inverter output on	<i>RUN2</i>	<i>RUN</i> (0)
36	1036	Overload prevention control	<i>OLP</i>	H70
37	1037	Current detected	<i>ID</i>	E34, E35, E37, E38
38	1038	Current detected 2	<i>ID2</i>	
42	1042	PID alarm	<i>PID-ALM</i>	J121 to J124 J221 to J225
43	1043	Under PID control	<i>PID-CTL</i>	J101, J201
44	1044	Motor stopped due to slow flowrate under PID control	<i>PID-STP</i>	J149 to J160 J249 to J260
45	1045	Low output torque detected	<i>U-TL</i>	E80, E81
52	1052	Running forward	<i>FRUN</i>	—
53	1053	Running reverse	<i>RRUN</i>	—

Function code data		Functions assigned	Symbol	Related function codes/signals (data)
Active ON	Active OFF			
54	1054	In remote operation	<i>RMT</i>	(See Section 5.5.4.)
55	1055	Run command entered	<i>AX2</i>	
56	1056	Motor overheat detected by thermistor	<i>THM</i>	H26, H27
59	1059	Terminal [C1] wire break	<i>CIOFF</i>	—
84	1084	Maintenance timer	<i>MNT</i>	H44, H78, H79
87	1087	Frequency arrival signal	<i>FARFDT</i>	
95	1095	Running in fire mode	<i>FMRUN</i>	H116 to H121
98	1098	Light alarm	<i>L-ALM</i>	H181 to H184
99	1099	Alarm output (for any alarm)	<i>ALM</i>	—
101	1101	EN terminal detection circuit error	<i>DECF</i>	
102	1102	EN terminal OFF	<i>ENOFF</i>	
111	1111	Customizable logic output signal 1	<i>CLO1</i>	U71 to U77 U81 to U87
112	1112	Customizable logic output signal 2	<i>CLO2</i>	
113	1113	Customizable logic output signal 3	<i>CLO3</i>	
114	1114	Customizable logic output signal 4	<i>CLO4</i>	
115	1115	Customizable logic output signal 5	<i>CLO5</i>	
116	1116	Customizable logic output signal 6	<i>CLO6</i>	
117	1117	Customizable logic output signal 7	<i>CLO7</i>	
190	1190	In timer operation	<i>TMD</i>	T01 to T19
191	1191	Timer 1 enabled	<i>TMD1</i>	
192	1192	Timer 2 enabled	<i>TMD2</i>	
193	1193	Timer 3 enabled	<i>TMD3</i>	
194	1194	Timer 4 enabled	<i>TMD4</i>	
200	1200	Under PID2 control	<i>PID2</i>	J101, J201
201	1201	PID1 alarm	<i>PV1-ALM</i>	J121, J122, J124
202	1202	PID1 feedback error	<i>PV1-OFF</i>	J127 to J131
203	1203	PID2 alarm	<i>PV2-ALM</i>	J221 to J225
204	1204	PID2 feedback error	<i>PV2-OFF</i>	J227 to J231
211	1211	Under external PID1 control	<i>EPID1-CTL</i>	J501
212	1212	External PID1 output	<i>EPID1-OUT</i>	
213	1213	Running under external PID1	<i>EPID1-RUN</i>	
214	1214	External PID1 alarm	<i>EPV1-ALM</i>	J521, J522, J524
215	1215	External PID1 feedback error	<i>EPV1-OFF</i>	J529 to J531
221	1221	Under external PID2 control	<i>EPID2-CTL</i>	J601
222	1222	External PID2 output	<i>EPID2-OUT</i>	
223	1223	Running under external PID2	<i>EPID2-RUN</i>	
224	1224	External PID2 alarm	<i>EPV2-ALM</i>	J621, J622, J624
225	1225	External PID2 feedback error	<i>EPV2-OFF</i>	J629 to J631

Function code data		Functions assigned	Symbol	Related function codes/signals (data)
Active ON	Active OFF			
231	1231	Under external PID3 control	<i>EPID3-CTL</i>	J651
232	1232	External PID3 output	<i>EPID3-OUT</i>	
233	1233	Running under external PID3	<i>EPID3-RUN</i>	
234	1234	External PID3 alarm	<i>EPV3-ALM</i>	J671, J672, J674
235	1235	External PID3 feedback error	<i>EPV3-OFF</i>	J679 to J681

 Any negative logic (Active OFF) command cannot be assigned to the functions marked with "-" in the "Active OFF" column.

- Inverter running -- **RUN** (Function code data = 0)
Inverter output on -- **RUN2** (Function code data = 35)

These output signals tell the external equipment that the inverter is running at a starting frequency or higher.

If assigned in negative logic (Active OFF), these signals can be used to tell the "Inverter being stopped" state.

Output signal	Basic function	Remarks
RUN	These signals come ON when the inverter is running. Under V/f control:	Goes OFF even during DC braking or dew condensation prevention.
RUN2	These signals come ON if the inverter output frequency exceeds the starting frequency, and go OFF if it drops below the stop frequency. The RUN signal can also be used as a "Speed valid" signal DNZS .	Comes ON even during DC braking, pre-exciting, zero speed control, or dew condensation prevention.

Under vector control, both **RUN** and **RUN2** come ON also when zero speed control or servo-lock function is enabled.

- Frequency (speed) arrival signal -- **FAR** (Function code data = 1)

These output signals come ON when the difference between the output frequency (detected speed) and reference frequency (reference speed) comes within the frequency arrival hysteresis width specified by E30.

 Refer to E30.

- Frequency (speed) detected -- **FDT** (Function code data = 2)

This output signal comes ON when the output frequency exceeds the frequency detection level specified by E31, and it goes OFF when the output frequency drops below the "Frequency detection level (E31) - Hysteresis width (E32)."

 Refer to E31 and E32.

- Undervoltage detected (Inverter stopped) -- **LU** (Function code data = 3)

This output signal comes ON when the DC link bus voltage of the inverter drops below the specified undervoltage level, and it goes OFF when the voltage exceeds the level.

When this signal is ON, the inverter cannot run even if a run command is given.

This signal is ON also when the undervoltage protective function is activated so that the motor is in an abnormal stop state (e.g., tripped).

-
- Inverter output limiting -- **IOL** (Function code data = 5)
Inverter output limiting with delay -- **IOL2** (Function code data = 22)

The output signal **IOL** comes ON when the inverter is limiting the output frequency by activating any of the following actions (minimum width of the output signal: 100 ms). The output signal **IOL2** comes ON when any of the following output limiting operation continues for 20 ms or more.

- Torque limiting (F40, F41, E16 and E17, Maximum internal value)
- Current limiting by software (F43 and F44)
- Instantaneous overcurrent limiting by hardware (H12 = 1)
- Automatic deceleration (Anti-regenerative control) (H69)

 **Note** When the **IOL** is ON, it may mean that the output frequency may have deviated from the reference frequency because of the limiting functions above.

- Auto-restarting after momentary power failure -- **IPF** (Function code data = 6)

This output signal is ON either during continuous running after a momentary power failure or during the period from when the inverter detects an undervoltage condition and shuts down its output until the completion of a restart sequence (until the output reaches the reference frequency).

 Refer to F14.

- Motor overload early warning -- **OL** (Function code data = 7)

This output signal is used to issue a motor overload early warning that enables you to take an corrective action before the inverter detects a motor overload alarm **OL1** and shuts down its output.

 Refer to E34.

- Inverter ready to run -- **RDY** (Function code data = 10)

This output signal comes ON when the inverter becomes ready to run by completing hardware preparation (such as initial charging of DC link bus capacitors and initialization of the control circuit) and no protective functions are activated.

- Switch motor drive source between commercial power and inverter output
-- **SW88**, **SW52-2** and **SW52-1** (Function code data = 11, 12, and 13)

Assigning these output signals to transistor output terminals [Y1], [Y2], [Y3] and [Y4] enables the terminal command **ISW50** or **ISW60** that controls the magnetic contactor for switching the motor drive source between the commercial power and the inverter output according to the integrated sequence.

 Refer to E01 through E07 (data = 40 and 41).

■ Select **AX** terminal function -- **AX** (Function code data = 15)

In response to a run command **FWD**, this output signal controls the magnetic contactor on the commercial-power supply side. It comes ON when the inverter receives a run command and it goes OFF after the motor decelerates to stop with a stop command received.

This signal immediately goes OFF upon receipt of a coast-to-stop command or when an alarm occurs.

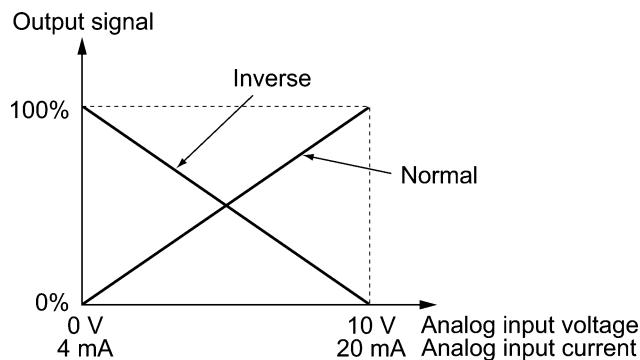
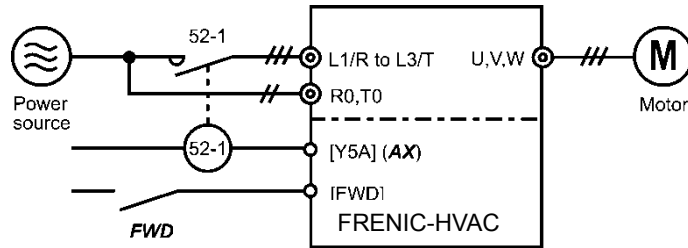

■ Shifted to pattern operation stage -- **TU** (Function code data = 16)

When the stage is shifted in pattern operation, the inverter issues a one-shot ON signal (100 ms), telling the shift of the stage.

Refer to C21 through C28.

■ Pattern operation cycle completed -- **TO** (Function code data = 17)

Upon completion of all stages (1 to 7) in pattern operation, the inverter issues a one-shot ON signal (100 ms), telling the completion of all stages.

Refer to C21 through C28.

- Pattern operation stage number
 - **STG1**, **STG2**, and **STG4** (Function code data = 18, 19, and 20)

With the combination of **STG1**, **STG2** and **STG4**, the inverter outputs the current operating stage.

📖 Refer to C21 through C28.

Pattern operation stage number	Output terminal		
	STG1	STG2	STG3
Stage 1	ON	OFF	OFF
Stage 2	OFF	ON	OFF
Stage 3	ON	ON	OFF
Stage 4	OFF	OFF	ON
Stage 5	ON	OFF	ON
Stage 6	OFF	ON	ON
Stage 7	ON	ON	ON

The inverter issues no signal from any of these terminals when a pattern operation is not carried out (no stage is selected).

- Cooling fan in operation -- **FAN** (Function code data = 25)

With the cooling fan ON/OFF control enabled (H06 = 1), this output signal is ON when the cooling fan is in operation, and OFF when it is stopped. This signal can be used to make the cooling system of peripheral equipment interlocked for an ON/OFF control.

📖 Refer to H06.

- Auto-resetting -- **TRY** (Function code data = 26)

This output signal comes ON when auto resetting (resetting alarms automatically) is in progress.

📖 Refer to H04 and H05.

- Universal DO -- **U-DO** (Function code data = 27)

Assigning this output signal to an inverter's output terminal and connecting the terminal to a digital input terminal of peripheral equipment via the RS-485 communications link or the fieldbus, allows the inverter to send commands to the peripheral equipment.

The universal DO can be used as an output signal independent of the inverter operation.

📖 For the procedure for access to Universal DO via the RS-485 communications link or fieldbus, refer to the respective instruction manual.

- Heat sink overheat early warning -- **OH** (Function code data = 28)

This output signal is used to issue a heat sink overheat early warning that enables you to take a corrective action before an overheat trip **OHI** actually happens.

This signal comes ON when the temperature of the heat sink exceeds the "overheat trip temperature minus 5°C (9°F)," and it goes OFF when it drops down to the "overheat trip temperature minus 8°C (14°F)."

■ Lifetime alarm -- **LIFE** (Function code data = 30)

This output signal comes ON when it is judged that the service life of any one of capacitors (DC link bus capacitors and electrolytic capacitors on the printed circuit boards), cooling fan, and real-time clock battery (option) has expired.

This signal should be used as a guide for replacement of these parts. If this signal comes ON, use the specified maintenance procedure to check the service life of these parts and determine whether the parts should be replaced or not.

Refer to H42.

■ Reference loss detected -- **REF OFF** (Function code data = 33)

This output signal comes ON when an analog input used as a frequency command source is in a reference loss state (as specified by E65) due to a wire break or a weak connection. This signal goes OFF when the normal operation under the analog input is resumed.

Refer to E65.

■ Overload prevention control -- **OLP** (Function code data = 36)

This output signal comes ON when overload prevention control is activated. The minimum ON-duration is 100 ms.

Refer to H70.

■ Current detected -- **ID** (Function code data = 37)
Current detected 2 -- **ID2** (Function code data = 38)

This output signal comes ON when the output current of the inverter exceeds the level specified by E34 (Current detection (Level)) for the period specified by E35 (Current detection (Timer)). The minimum ON-duration is 100 ms.

Refer to E34 and E35.

■ PID alarm -- **PID-ALM** (Function code data = 42)

Assigning this output signal enables PID control to output absolute-value alarm or deviation alarm.

Refer to J121 through J124 and J221 through J225.

■ Under PID control -- **PID-CTL** (Function code data = 43)

This output signal comes ON when PID control is enabled ("Cancel PID control" (**Hz/PID**) = OFF) and a run command is ON.

Refer to J101 and J201.

Note When PID control is enabled, the inverter may stop function with the **PID-CTL** signal being ON. As long as the **PID-CTL** signal is ON, PID control is effective, so the inverter may abruptly resume its operation, depending on the feedback value in PID control.

⚠ WARNING

When PID control is enabled, even if the inverter stops its output during operation because of sensor signals or other reasons, operation will resume automatically.

Design your machinery so that safety is ensured even in such cases.

Otherwise, an accident could occur.

- Motor stopped due to slow flowrate under PID control -- **PID-STP**
(Function code data = 44)

This output signal is ON when the inverter is stopped due to the slow flowrate stop function under PID control.)

📖 Refer to J149 through J160 and J249 through J260.

- Low output torque detected -- **U-TL** (Function code data = 45)

This output signal comes ON when the torque value calculated by the inverter or torque command drops below the level specified by E80 (Low torque detection (Level)) for the period specified by E81 (Low torque detection (Timer)). The minimum ON-duration is 100 ms.

📖 Refer to E80 and E81.

- Running forward -- **FRUN** (Function code data = 52)
Running reverse -- **RRUN** (Function code data = 53)

Output signal	Assigned data	Running forward	Running reverse	Inverter stopped
FRUN	52	ON	OFF	OFF
RRUN	53	OFF	ON	OFF

- In remote operation -- **RMT** (Function code data = 54)

This output signal comes ON when the inverter switches from local to remote mode.

📖 For details of switching between remote and local modes, refer to Chapter 5, Section 5.5.4 "Remote and local modes."

- Run command entered -- **AX2** (Function code data = 55)

This output signal comes ON the moment the inverter is ready to run after receipt of a run command.

📖 Refer to E01 through E07, Function code data = 38.

- Motor overheat detected by thermistor -- **THM** (Function code data = 56)

Even when the PTC thermistor on the motor detects an overheat, the inverter turns this signal ON and continues to run, without entering the alarm **OH4** state. This feature applies only when H26 data is set to "2."

📖 Refer to H26 and H27.

- Terminal [C1] wire break -- **C1OFF** (Function code data = 59)

This output signal comes ON when the inverter detects that the input current to terminal [C1] drops below 2 mA interpreting it as the terminal [C1] wire broken.

- Maintenance timer -- **MNT** (Function code data = 84)

Once the inverter's cumulative run time or the startup times for the motor 1 exceeds the previously specified count, this output signal comes ON.

📖 Refer to H44, H78 and H79.

- Frequency arrival signal (with frequency detection)
-- **FARFDT** (Function code data = 87)

This output signal comes ON when both the **FAR** (Frequency arrival signal) and **FDT** (Frequency detected) come ON. (The **FARFDT** is an AND condition signal of the **FAR** and **FDT**.)

■ Running in fire mode -- **FMRUN** (Function code data = 95)

This output signal comes ON in fire mode.

Refer to H116 through H121.

■ Light alarm -- **L-ALM** (Function code data = 98)

This output signal comes ON when a light alarm occurs.

Refer to H181 through H184.

■ Alarm output (for any alarm) -- **ALM** (Function code data = 99)

This output signal comes ON if any of the protective functions is activated and the inverter enters Alarm mode.

■ EN terminal detection circuit error -- **DECF** (Function code data = 101)

This output signal comes ON when an error is detected in the Enable circuit.

As necessary, make use of **DECF** in wiring that feeds back the **DECF**-assigned transistor output of the inverter to the reset input of an upper safety relay unit in order to turn the Enable command OFF and shut down the inverter output.

■ EN terminal OFF -- **ENOFF** (Function code data = 102)

This output signal comes ON when Enable inputs to terminals [EN1] and [EN2] are OFF.

*1 These signals do not guarantee the detection of all signal alarms. (Compliant with EN ISO13849-1 PL = d Cat. 3)

Logic Table of DECF and ENOFF Signals

Power supply L1/R, L2/S, L3/T	Enable input		Transistor output or alarm output (for any alarm) *2		Output
	EN1-PLC	EN2-PLC	DECF	ENOFF	
OFF	√	√	OFF	OFF	Shutdown (Safe Torque OFF *3)
ON	OFF	OFF	OFF	ON	Shutdown (Safe Torque OFF *3)
	ON	ON	OFF	OFF	Waiting for a run command
	ON	OFF	ON *4	OFF	Shutdown (Safe Torque OFF *3)
	OFF	ON	ON *4	OFF	Shutdown (Safe Torque OFF *3)

√: The output level is determined independent of the states.

*2 To use this function, it is necessary to set the software parameter to DECF/ENOFF = 101/102 (negative logic).

*3 Safe Torque OFF (STO) defined by IEC61800-5-2.

*4 If either one of Enable inputs to [EN1] and [EN2] is OFF, an alarm (ECF) occurs. (If the status is kept exceeding 50 ms, it is judged as mismatch.) This alarm can be removed only by restarting the inverter.

- Cancel timer -- **TMD** (Function code data = 190)
 - Timer 1 to Timer 4 enabled -- **TMD1** to **TMD4** (Function code data = 191 to 194)
- With the combination of **TMD1** to **TMD4**, the inverter outputs the current state of timer operation.

📖 Refer to T01 through T19.

Timer operation state	Output status of external output signals				
	TMD	TMD1	TMD2	TMD3	TMD4
Timer operation disabled (no setting or being canceled)	OFF	OFF	OFF	OFF	OFF
Timer operation time invalid	OFF	OFF	OFF	OFF	OFF
Timer 1	ON	ON	OFF	OFF	OFF
Timer 2		OFF	ON	OFF	OFF
Timer 3		OFF	OFF	ON	OFF
Timer 4		OFF	OFF	OFF	ON
Timers 1 + 2		ON	ON	OFF	OFF
Timers 1 + 3		ON	OFF	ON	OFF
Timers 1 + 4		ON	OFF	OFF	ON
Timers 2 + 3		OFF	ON	ON	OFF
Timers 2 + 4		OFF	ON	OFF	ON
Timers 3 + 4		OFF	OFF	ON	ON
Timers 1 + 2 + 3		ON	ON	ON	OFF
Timers 1 + 2 + 4		ON	ON	OFF	ON
Timers 1 + 3 + 4		ON	OFF	ON	ON
Timers 2 + 3 + 4		OFF	ON	ON	ON
Timers 1 + 2 + 3 + 4		ON	ON	ON	ON

- Under PID2 control -- **PID2** (Function code data = 200)

This output signal comes ON when PID control 2 is selected.

📖 Refer to J101 and J201.

- PID1 alarm -- **PV1-ALM** (Function code data = 201)

This output signal comes ON when a PID1 alarm occurs.

📖 Refer to J121, J122, and J124.

- PID1 feedback error -- **PV1-OFF** (Function code data = 202)

This output signal comes ON when a feedback (PV) level error occurs.

📖 Refer to J127 through J131.

- PID2 alarm -- **PV2-ALM** (Function code data = 203)

This output signal comes ON when a PID2 alarm occurs.

📖 Refer to J221 through J225.

- PID2 feedback error -- **PV2-OFF** (Function code data = 204)

This output signal comes ON when a feedback (PV) level error occurs.

Refer to J227 through J231.

- Under external PID1 to PID3 control-- **EPID1-CTL**, **EPID2-CTL**, and **EPID3-CTL** (Function code data = 211, 221, and 231)

These signals come ON when external PID control 1 to 3 are selected, respectively.

Refer to J501, J601, and J651.

- External PID1 to PID3 output -- **EPID1-OUT**, **EPID2-OUT**, and **EPID3-OUT** (Function code data = 212, 222, and 232)

These signals are duty output of external PID control 1 to 3.

Refer to J501, J601, and J651.

- Running under external PID1 to PID3 -- **EPID1-RUN**, **EPID2-RUN**, and **EPID3-RUN** (Function code data = 213, 223, and 233)

These signals come ON when external PID control 1 to 3 are activated, respectively.

Refer to J501, J601, and J651.

- External PID1 to PID3 alarm -- **EPV1-ALM**, **EPV2-ALM**, and **EPV3-ALM** (Function code data = 214, 224, and 234)

These signals come ON when external PID1 to PID3 alarms occur with external PID control 1 to 3 selected.

Refer to J521, J522, J524, J621, J622, J624, J671, J672, and J674.

- External PID1 to PID3 feedback error -- **EPV1-OFF**, **EPV2-OFF**, **EPV3-OFF** (Function code data = 215, 225, and 235)

These signals come ON when a feedback (PV) level error occurs when external PID control 1 to 3 are selected, respectively.

Refer to J529 through J531, J629 through J631, and J679 through J681.

E30

Frequency Arrival (Hysteresis width)

E30 specifies the detection level (hysteresis width) for the "Frequency (speed) arrival signal" **FAR**.

Output signal	Data assigned to output terminal	Operating condition 1	Operating condition 2
Frequency (speed) arrival signal FAR	1	Both signals come ON when the difference between the output frequency and the reference frequency comes within the frequency arrival hysteresis width specified by E30.	FAR always goes OFF when the run command is OFF or the reference speed is "0."

- Data setting range: 0.0 to 10.0 (Hz)

The operation timings of each signal are as shown below.

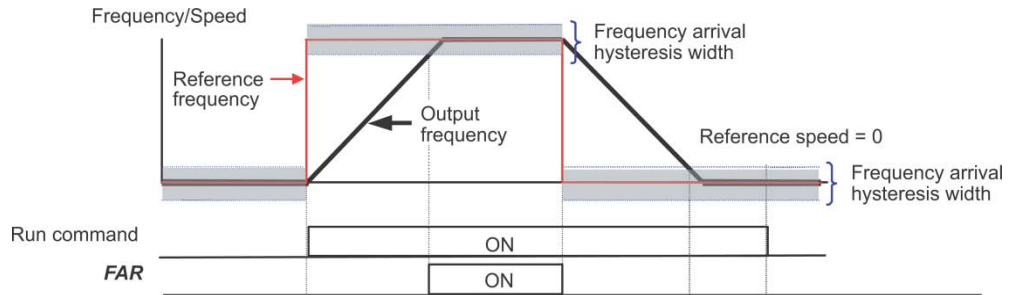

E31, E32 Frequency Detection (Level and Hysteresis width)

When the output frequency (estimated/detected speed) exceeds the frequency detection level specified by E31, the "Frequency (speed) detected signal" comes ON; when it drops below the "Frequency detection level minus Hysteresis width specified by E32," it goes OFF.

Output signal	Data assigned to output terminal	Operation level	Hysteresis width
		Range: 0.0 to 120.0 Hz	Range: 0.0 to 120.0 Hz
Frequency (speed) detected signal FDT	2	E31	E32

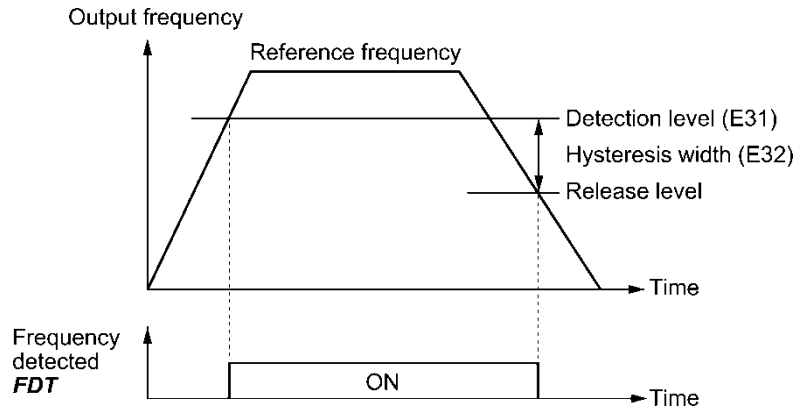

E34, E35 Overload Early Warning/Current Detection (Level and Timer)
E37, E38 Current Detection 2 (Level and Timer)

These function codes define the detection level and time for the "Motor overload early warning" **OL**, "Current detected" **ID**, and "Current detected 2" **ID2** *1.

Output signal	Data assigned to output terminal	Operation level	Timer	Motor characteristics	Thermal time constant
		Range: See below	Range: 0.01 to 600.00 s	Range: See below	Range: 0.5 to 75.0 min
OL	7	E34	-	F10	F12
ID	37	E34	E35	-	-
ID2 *1	38	E37	E38		

*1 ID2 signal is available at ROM version 2450 or later.

- Data setting range

Operation level: OFF (Disable), 1 to 150% of inverter rated current

Motor characteristics 1: Enable (For a general-purpose motor with shaft-driven cooling fan)

2: Enable (For an inverter-driven motor, non-ventilated motor, or motor with separately powered cooling fan)

■ Motor overload early warning signal -- **OL**

The **OL** signal is used to detect a symptom of an overload condition (alarm code **OL1**) of the motor so that the user can take an appropriate action before the alarm actually happens.

The **OL** signal turns ON when the inverter output current exceeds the level specified by E34. In typical cases, set E34 data to 80 to 90% against F11 data (Electronic thermal overload protection for motor 1, Overload detection level). Specify also the thermal characteristics of the motor with F10 (Select motor characteristics) and F12 (Thermal time constant).

■ Current detected -- **ID**, and Current detected 2 -- **ID2**

When the inverter output current exceeds the level specified by E34 for the period specified by E35, the **ID** signal turns ON, respectively. When the output current drops below 90% of the rated operation level, the **ID** turns OFF. (The minimum ON-duration is 100 ms.)

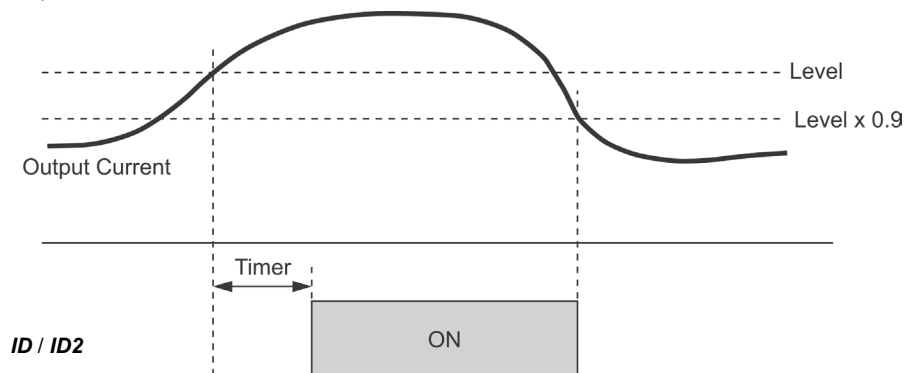

E61 to E63

Terminal [12] Extended Function
Terminal [C1] Extended Function
Terminal [V2] Extended Function

E61, E62, and E63 define the function of the terminals [12], [C1], and [V2], respectively. There is no need to set up these terminals if they are to be used for frequency command sources.

Data for E61, E62, or E63	Input assigned to [12], [C1] and [V2]:	Description
0	None	—
1	Auxiliary frequency command 1	Auxiliary frequency input to be added to the reference frequency given by frequency command 1 (F01). Will not be added to any other reference frequency given by frequency command 2 and multistep frequency commands, etc.
2	Auxiliary frequency command 2	Auxiliary frequency input to be added to all reference frequencies given by frequency command 1, frequency command 2, multistep frequency commands, etc.
3	PID process command 1	Inputs command sources such as temperature and pressure under PID control 1 or 2. Function code setting also required: J102/202 = 1
4	PID process command 2	Inputs the second command sources under PID control 1 or 2. Function code setting also required: J102/202 = 1
5	PID feedback value 1	Inputs feedback amounts such as temperature and pressure under PID control 1 or 2.
12	Acceleration/deceleration time ratio setting	To be used for making ratio setting by analog input to acceleration/deceleration time.
13	Upper limit frequency	To be used for limiting the output frequency by analog input.
14	Lower limit frequency	
20	Analog signal input monitor	By inputting analog signals from various sensors such as the temperature sensors in air conditioners to the inverter, you can monitor the state of external devices via the communications link. By using an appropriate display coefficient, you can also have various values to be converted into physical quantities such as temperature and pressure before they are displayed.
30	PID feedback value 2	Inputs the 2nd feedback amounts under PID control 1 or 2.
31	Auxiliary input 1 to PID process command	Auxiliary analog input to be added to the process command under PID control 1 or 2.
32	Auxiliary input 2 to PID process command	2nd auxiliary analog input to be added to the process command under PID control 1 or 2.
33	Flowrate sensor	Input from the flowrate sensor.
41	External PID process command 1	Inputs command sources such as temperature and pressure under external PID control 1, 2 or 3. Function code setting also required: J502/J602/J652
42	External PID feedback value 1	Inputs feedback amounts such as temperature and pressure under external PID control 1, 2 or 3.
43	External PID manual command 1	To be used for setting PID output (MV) manually when external PID control 1 is canceled.





Data for E61, E62, or E63	Input assigned to [12], [C1] and [V2]:	Description
44	External PID process command 2	Inputs the 2nd command sources such as temperature and pressure under external PID control 2 or 3. Function code setting also required: J602/J652
45	External PID feedback value 2	Inputs the 2nd feedback amounts such as temperature and pressure under external PID control 2 or 3. Under external PID control 1, external PID feedback value 1 and addition, difference, average, maximum and minimum can be calculated.
46	External PID manual command 2	To be used for setting PID output (MV) manually when external PID control 2 is canceled.
47	External PID process command 3	Inputs the 3rd command sources such as temperature and pressure under external PID control 3. Function code setting also required: J652
48	External PID feedback value 3	Inputs the 3rd feedback amounts such as temperature and pressure under external PID control 3.
49	External PID manual command 3	To be used for setting PID output (MV) manually when external PID control 3 is canceled.





 **Note** If these terminals have been set up to have the same data, the operation priority is given in the following order:

E61 > E62 > E63

E64

Saving of Digital Reference Frequency

E64 specifies how to save the reference frequency specified in digital formats by the  /  /  /  keys on the keypad as shown below.

Data for E64	Function
0	Auto saving when the main power is turned OFF The reference frequency will be automatically saved when the main power is turned OFF. At the next power-on, the reference frequency at the time of the previous power-off applies.
1	Saving by pressing  key Pressing the  key saves the reference frequency. If the control power is turned OFF without pressing the  key, the data will be lost. At the next power-ON, the inverter uses the reference frequency saved when the  key was pressed last.

E65

Reference Loss Detection (Continuous running frequency)

When the analog frequency command (setting through terminal [12], [C1], or [V2]) has dropped below 10% of the reference frequency within 400 ms, the inverter presumes that the analog frequency command wire has been broken and continues its operation at the frequency determined by the ratio specified by E65 to the reference frequency. Refer to E20 through E24 and E27 (data = 33).

When the frequency command level (in voltage or current) returns to a level higher than that specified by E65, the inverter presumes that the broken wire has been fixed and continues to run following the frequency command.

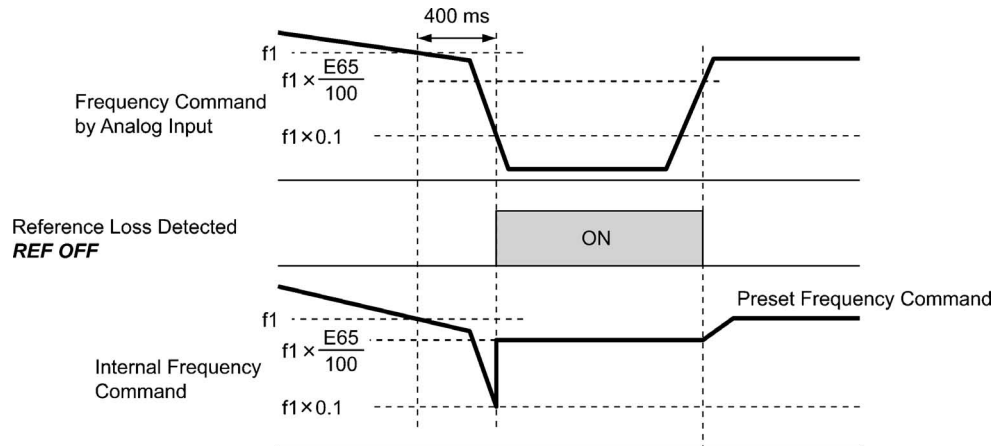

In the diagram above, f_1 is the level of the analog frequency command sampled at any given time. The sampling is repeated at regular intervals to continually monitor the wiring connection of the analog frequency command.

- Data setting range: Decel (Decelerate to stop)
20 to 120 %
OFF (Cancel)

Note Avoid an abrupt voltage or current change for the analog frequency command. An abrupt change may be interpreted as a wire break.

When E65 = OFF (Cancel), the inverter issues the **REF OFF** signal ("Reference loss detected") but does not change the reference frequency so that it runs at the analog frequency command as specified.

When E65 = "Decel" or OFF, the reference frequency level at which the broken wire is recognized as fixed is " $f_1 \times 0.2$."

When E65 = "100" (%) or higher, the reference frequency level at which the wire is recognized as fixed is " $f_1 \times 1$."

The reference loss detection is not affected by the setting of analog input adjustment (filter time constants: C33, C38, and C43).

E80, E81**Low Torque Detection (Level and Timer)**

E80 and E81 specify the operation level and the timer for the output signal *U-TL*, respectively.

Output signal	Assigned data	Operation level	Timer
		Range: 0 to 150%	Range: 0.01 to 600.00 s
<i>U-TL</i>	45	E80	E81

■ Low output torque detected -- *U-TL*

This output signal comes ON when the torque value calculated by the inverter or torque command drops below the level specified by E80 (Low torque detection (Level)) for the period specified by E81 (Low torque detection (Timer)). The signal turns OFF when the calculated torque exceeds "the level specified by E80 plus 5% of the motor rated torque." The minimum ON-duration is 100 ms.

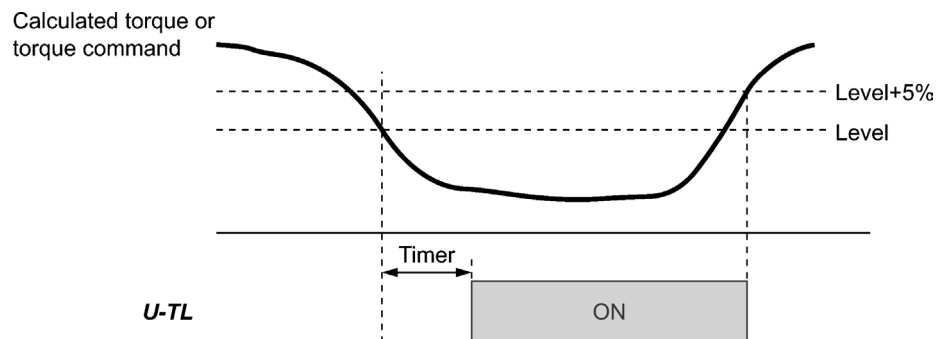

In the inverter's low frequency operation, as a substantial error in torque calculation occurs, no low torque can be detected within the operation range at less than 20% of the base frequency (F04). (In this case, the result of recognition before entering this operation range is retained.)

The *U-TL* signal goes off when the inverter is stopped.

Since the motor parameters are used in the calculation of torque, it is recommended that auto-tuning be applied by function code P04 to achieve higher accuracy.

E98, E99

Terminal [FWD] Function
Terminal [REV] Function

(Refer to E01 to E07.)

For details about the configuration of terminals [FWD] and [REV], refer to the descriptions of E01 to E07.

When [FWD] or [REV] is ON, it is not possible to change the E98 or E99 data, respectively.

6.3.3 C codes (Control functions)

C01 to C03
C94 to C96
C04

Jump Frequency 1, 2 and 3
Jump Frequency 4, 5 and 6,
Jump Frequency (Hysteresis width)

These function codes enable the inverter to jump over six different points on the output frequency in order to skip resonance caused by the motor speed and natural frequency of the driven machinery (load).

- When the inverter is increasing the reference frequency, the moment the reference frequency reaches the bottom of the jump frequency band, the inverter keeps the output at that bottom frequency. When the reference frequency exceeds the upper limit of the jump frequency band, the internal reference frequency takes on the value of the reference frequency. When the inverter is decreasing the reference frequency, the situation will be reversed.
- When more than two jump frequency bands overlap, the inverter actually takes the lowest frequency within the overlapped bands as the bottom frequency and the highest as the upper limit. Refer to the figure on the lower right.

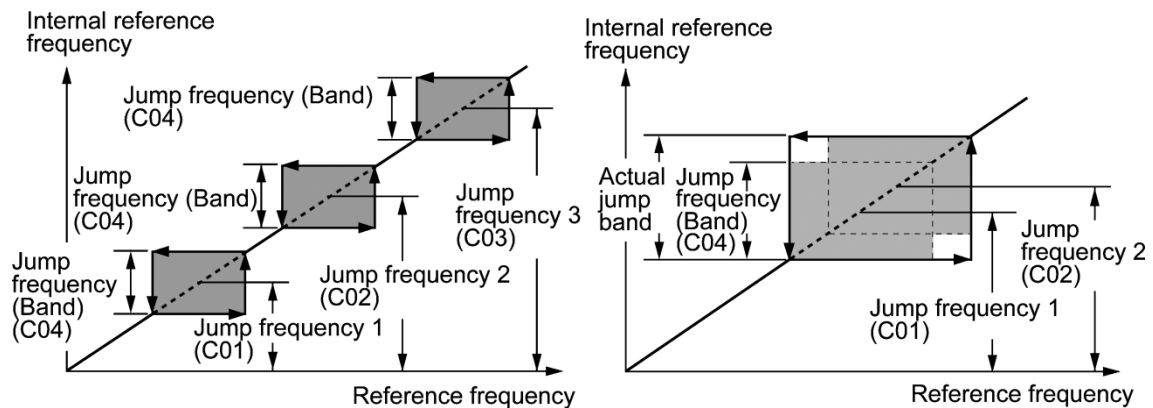

- Jump frequencies 1, 2 and 3 (C01, C02 and C03)
- Jump frequencies 4, 5 and 6 (C94, C95 and C96) *1

Specify the center of the jump frequency band.

- Data setting range: 0.0 to 120.0 (Hz) (Setting to 0.0 results in no jump frequency band.)

- Jump frequency hysteresis width (C04)

Specify the jump frequency hysteresis width.

- Data setting range: 0.0 to 30.0 (Hz) (Setting to 0.0 results in no jump frequency band.)

*1 Jump frequencies 4 - 6 (C94 - C96) are available at ROM version [2450](#) or later.

C05 to C19

Multistep frequency 1 to 15

These function codes specify 15 frequencies to apply when switching frequencies by turning terminal commands **SS1**, **SS2**, **SS4** and **SS8** ON or OFF selectively, as listed below.

Using this feature requires assigning **SS1**, **SS2**, **SS4** and **SS8** ("Select multistep frequency") to digital input terminals (data = 0, 1, 2, and 3) with E01 to E07 beforehand.

- Multistep frequency 1 to 15 (C05 through C19)

- Data setting range: 0.00 to 120.00 (Hz)

The combination of **SS1**, **SS2**, **SS4** and **SS8** and the selected frequencies are as follows.

SS8	SS4	SS2	SS1	Selected frequency command
OFF	OFF	OFF	OFF	Other than multistep frequency *
OFF	OFF	OFF	ON	C05 (Multistep frequency 1)
OFF	OFF	ON	OFF	C06 (Multistep frequency 2)
OFF	OFF	ON	ON	C07 (Multistep frequency 3)
OFF	ON	OFF	OFF	C08 (Multistep frequency 4)
OFF	ON	OFF	ON	C09 (Multistep frequency 5)
OFF	ON	ON	OFF	C10 (Multistep frequency 6)
OFF	ON	ON	ON	C11 (Multistep frequency 7)
ON	OFF	OFF	OFF	C12 (Multistep frequency 8)
ON	OFF	OFF	ON	C13 (Multistep frequency 9)
ON	OFF	ON	OFF	C14 (Multistep frequency 10)
ON	OFF	ON	ON	C15 (Multistep frequency 11)
ON	ON	OFF	OFF	C16 (Multistep frequency 12)
ON	ON	OFF	ON	C17 (Multistep frequency 13)
ON	ON	ON	OFF	C18 (Multistep frequency 14)
ON	ON	ON	ON	C19 (Multistep frequency 15)

* "Other than multistep frequency" includes frequency command 1 (F01), frequency command 2 (C30) and other command sources except multistep frequency commands.

■ When PID control is disabled (**Hz/PID = ON**)

Multistep frequency commands (15 steps) can also be used for a manual speed command.

C21	Pattern Operation (Mode selection)
------------	---

C21 specifies the mode of a pattern operation in which the inverter automatically runs the motor according to the preset running period, rotation direction, acceleration/deceleration time and reference frequency.

To use this function, set both F01 (Frequency command 1) and C30 (Frequency command 2) to "10" (Pattern operation).

The following three pattern operation modes are available.

Data for C21	Pattern Operation Modes
0	Carry out a single cycle of the specified pattern operation and stop the inverter output.
1	Carry out the specified pattern operation repeatedly and stop the inverter output upon receipt of a stop command.
2	Carry out a single cycle of the specified pattern operation and continue to run at the last reference frequency.

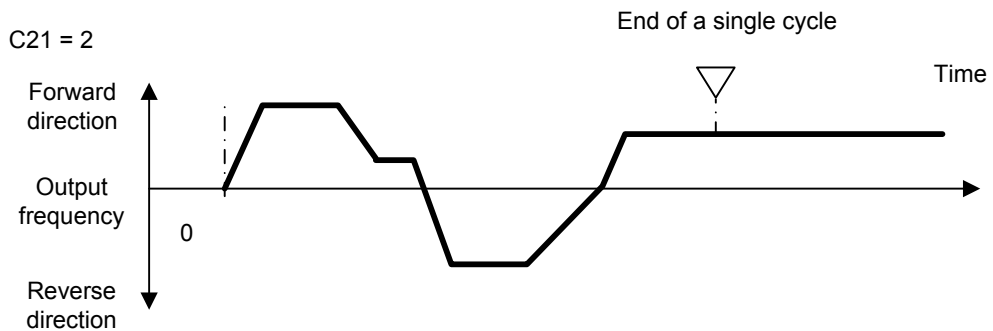
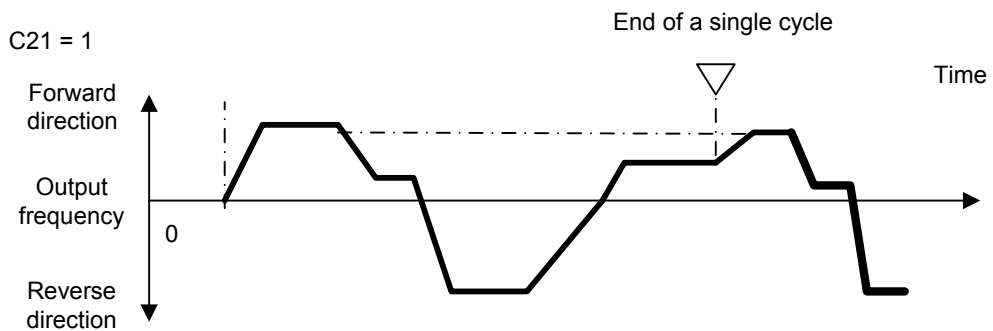
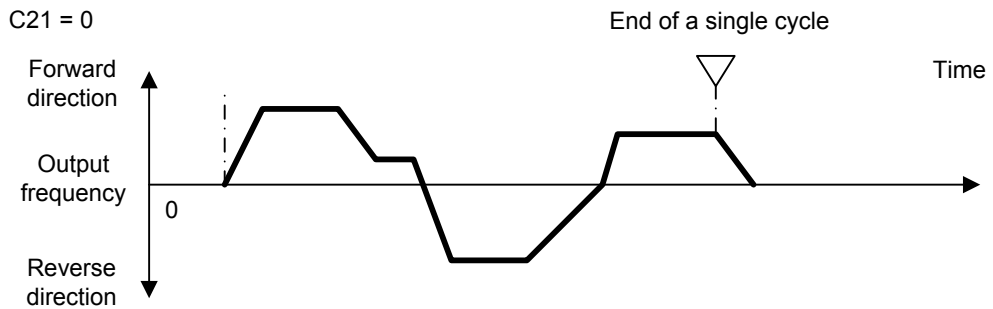

C22 to C28 configure stages 1 to 7, respectively, by setting the run time, motor rotation direction and acceleration/deceleration time for each stage.

The inverter runs in the order of stages 1 to 7 (in the order of C22 to C28).

Items to be Configured for Each Stage	Data Setting Range
Run time	0.00 to 6000.00 s (*)
Motor rotation direction	FWD: Forward direction (clockwise) REV: Reverse direction (counterclockwise)
Acceleration/deceleration time	1: F07 (Acceleration time 1), F08 (Deceleration time 1)
	2: E10 (Acceleration time 2), E11 (Deceleration time 2)
	3: E12 (Acceleration time 3), E13 (Deceleration time 3)
	4: E14 (Acceleration time 4), E15 (Deceleration time 4)

(*) The number of significant figures for the run time is 3. Upper three digits can be set.

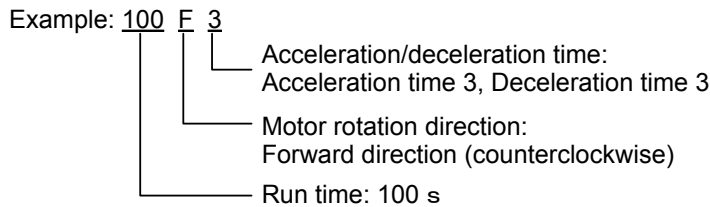

Setting the run time at "0.00 s" skips the corresponding stage to the next one.

Reference frequencies to be applied in a pattern operation are multistep frequencies 1 to 7 (C05 to C11) assigned to stages 1 to 7, respectively, as listed below. Specify multistep frequencies with C05 to C11.

Stage No.	Reference frequency
Stage 1	C05 (Multistep frequency 1)
Stage 2	C06 (Multistep frequency 2)
Stage 3	C07 (Multistep frequency 3)
Stage 4	C08 (Multistep frequency 4)
Stage 5	C09 (Multistep frequency 5)
Stage 6	C10 (Multistep frequency 6)
Stage 7	C11 (Multistep frequency 7)

■ Pattern Operation Configuration Example

Function code	Setting data	Reference frequency
C21 (Mode selection)	1	--
C22 (Stage 1)	60.00 s FWD 2	C05 Multistep frequency 1
C23 (Stage 2)	100.00 s FWD 1	C06 Multistep frequency 2
C24 (Stage 3)	65.50 s REV 4	C07 Multistep frequency 3
C25 (Stage 4)	55.00 s REV 3	C08 Multistep frequency 4
C26 (Stage 5)	50.00 s FWD 2	C09 Multistep frequency 5
C27 (Stage 6)	72.00 s FWD 4	C10 Multistep frequency 6
C28 (Stage 7)	35.00 s FWD 2	C11 Multistep frequency 7

The above configuration example produces the operation shown in the chart below.

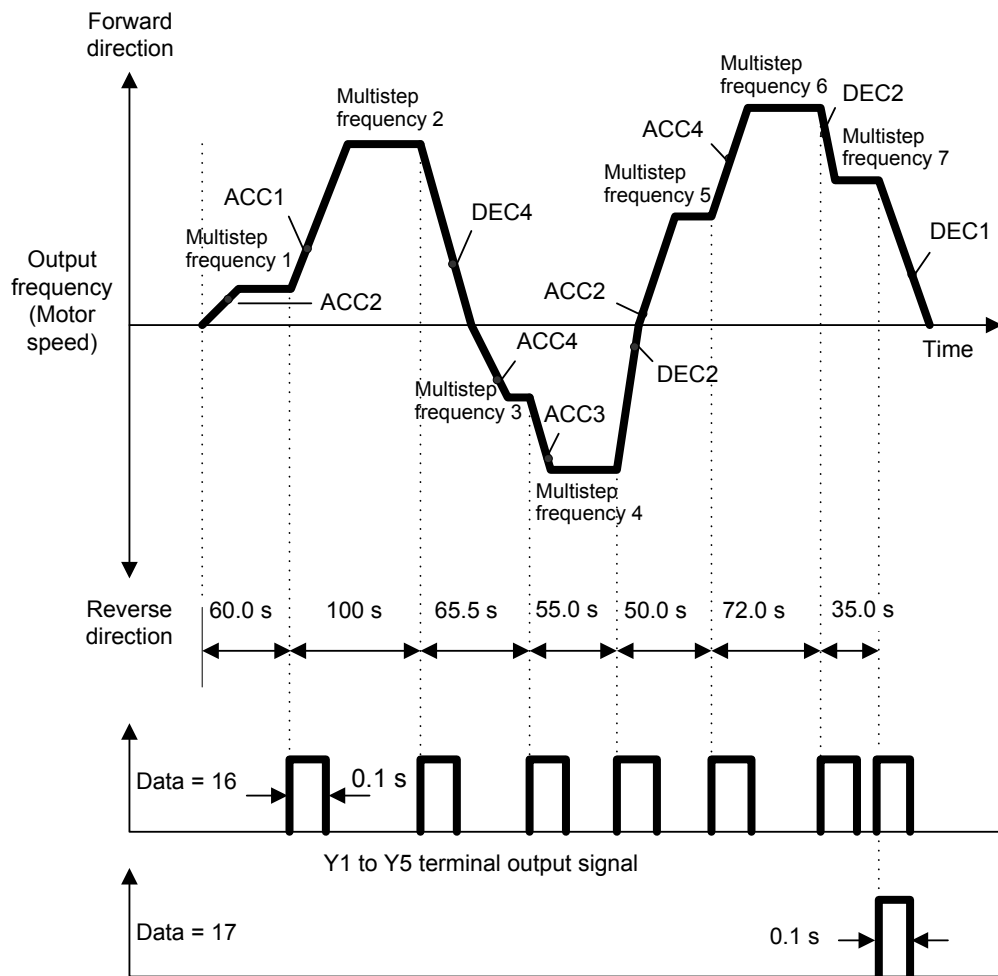

To start or stop a pattern operation, use the FWD / STOP keys on the keypad or turn the related input terminals ON/OFF.

When using the keypad, for example, press the FWD key to start a pattern operation. To stop the current stage temporarily, press the STOP key. Press the FWD key again to start the pattern operation from the stopped point of that stage.

Halfway through a pattern operation, to run the inverter from Stage 1 (C22), enter a stop command and then press the RESET key.

If the inverter stops due to an alarm, press the RESET key to cancel the inverter protective function and then press the FWD key again. The stopped stage starts again.

Note: Entry of a reverse rotation command with the (REV) key or terminal [REV] cancels the run command and produces no inverter operation. The rotation direction should be specified by the data of C21 to C28.

Note: When an pattern operation is commanded via input terminals, the self-hold function of a run command does not work. Use an alternate switch if necessary.

Note: After completion of a cycle of pattern operation, the inverter decelerates to a stop with the deceleration time specified by F08 (Deceleration time 1).

C30	Frequency Command 2	(Refer to F01.)
------------	----------------------------	------------------------

For details of frequency command 2, refer to the description of F01.

C31 to C35 C36 to C39 C41 to C45 C40	Analog Input Adjustment for [12] (Offset, Gain, Filter time constant, Gain base point, Polarity) Analog Input Adjustment for [C1] (Offset, Gain, Filter time constant, Gain base point) Analog Input Adjustment for [V2] (Offset, Gain, Filter time constant, Gain base point, Polarity) Terminal [C1] Input Range Selection	F01 (Frequency Command 1)
---	---	----------------------------------

Setting up a reference frequency using analog input

You can adjust the gain, polarity, filter time constant, and offset which are applied to analog inputs (voltage inputs to terminals [12] and [V2], and current input to terminal [C1]).

Adjustable items for analog inputs

Input terminal	Input range	Gain		Polarity	Filter time constant	Offset	Terminal [C1] input range
		Gain	Base point				
[12]	0 to +10 V, -10 to +10 V	C32	C34	C35	C33	C31	—
[C1]	4 to 20 mA	C37	C39	—	C38	C36	C40
[V2]	0 to +10 V, -10 to +10 V	C42	C44	C45	C43	C41	—

■ Offset (C31, C36, C41)

C31, C36 or C41 configures an offset for an analog voltage/current input. The offset also applies to signals sent from the external equipment.

- Data setting range: -5.0 to +5.0 (%)

■ Filter time constant (C33, C38, C43)

C33, C38 or C43 configures a filter time constant for an analog voltage/current input. The larger the time constant, the slower the response. Specify the proper filter time constant taking into account the response speed of the machine (load). If the input voltage fluctuates due to line noises, increase the time constant.

- Data setting range: 0.00 to 5.00 (s)

■ Polarity (C35, C45)

C35 and C45 configure the input range for analog input voltage.

Data for C35 and C45	Specifications for terminal inputs
0	-10 to +10 V
1	0 to +10 V (A minus component of the input will be regarded as 0 VDC.)

■ Gain (C32, C37, C42)

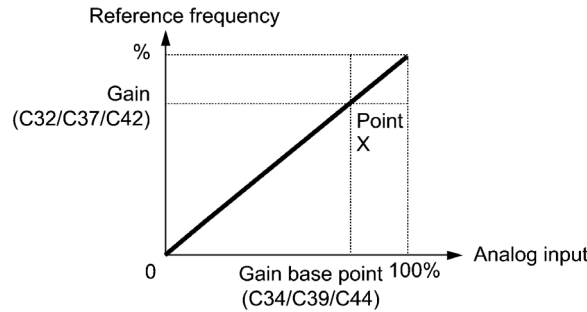

Note To input bipolar analog voltage (0 to ±10 VDC) to terminals [12] and [V2], set C35 and C45 data to "0." Setting C35 and C45 data to "1" enables the voltage range from 0 to +10 VDC and interprets the negative polarity input from 0 to -10 VDC as 0 V.

■ Terminal [C1] input range selection (C40)

C40 specifies the input range of terminal [C1] (analog input current).

Data for C40	Terminal [C1] input range
0	4 to 20 mA (factory default)
1	0 to 20 mA

C53 Selection of Normal/Inverse Operation (Frequency command 1)

C53 switches the reference frequency sourced by frequency command 1 (F01) between normal and inverse.

Note For details, refer to E01 through E07 (data = 21) for the terminal command *IVS* ("Switch normal/inverse operation").

C55 Analog Input Adjustment for Terminal [12] (Bias value) (Refer to F01.)

C55 specifies a bias value to apply to terminal [12] input of reference frequency 2, analog input monitor and PID control input. For details, refer to the description of F01.

C56 Analog Input Adjustment for Terminal [12] (Bias base point) (Refer to F01.)

C56 specifies a bias base point for Reference frequency 2 and analog input monitor terminal [12]. For details, refer to the description of F01.

C58**Analog Input Adjustment for Terminal [12] (Display unit)**

C58 specifies the display unit for analog input monitor, PID control commands and feedback amounts on terminal [12].

The specified display unit appears when analog input monitor, SV and PV are displayed on the main or sub monitor.

Data for C58	Display unit	Data for C58	Display unit	Data for C58	Display unit
1	No display unit	24	L/min (Flowrate)	46	Psi (Pressure)
2	%	25	L/h (Flowrate)	47	mWG (Pressure)
4	r/min	40	Pa (Pressure)	48	inWG (Pressure)
7	kW	41	kPa (Pressure)	60	K (Temperature)
20	m ³ /s (Flowrate)	42	MPa (Pressure)	61	°C (Temperature)
21	m ³ /min (Flowrate)	43	mbar (Pressure)	62	°F (Temperature)
22	m ³ /h (Flowrate)	44	bar (Pressure)	80	ppm (Density)
23	L/s (Flowrate)	45	mmHg (Pressure)		

Setting up an analog input monitor for terminal [12]

1) Input monitor

Set E61 (Terminal [12] extended function) to "20."

2) Display section

Set any of K10 (Main monitor display), K16 (Sub monitor 1 display) and K17 (Sub monitor 2 display) to "27" (Analog input monitor).

For details, refer to Chapter 5, Section 5.5.1 "Monitoring the running status."

3) Display unit

Select the desired display unit with C58.

4) Scale

- Maximum scale (C59): Set a physical quantity to be displayed when the analog input value is 100%.
- Minimum scale (C60): Set a physical quantity to be displayed when the analog input value is 0%.

C59, C60**Analog Input Adjustment for Terminal [12] (Maximum scale, Minimum scale)**

C59 and C60 specify the maximum and minimum scales to display easy-to-understand physical quantity converted from analog input on terminal [12].

- Data setting range: -999.00 to 0.00 to 9990.00 for maximum and minimum scales

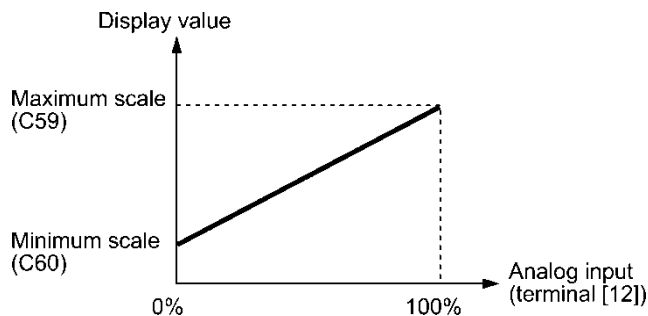

Example: To detect 0 to 30 kPa with 1 to 5 V output of the pressure sensor

- 1) Input monitor
Set E61 (Terminal [12] extended function) to "20."
 - 2) Gain
To interpret 5V as 100%, set the gain to 200% (C32 = 100%, C34 = 50%).
 - 3) Scale
 - Maximum scale (C59): Set 30.0 to be displayed when the analog input value on terminal [12] is 100%.
 - Minimum scale (C60): Set -7.5 to be displayed when the analog input value on terminal [12] is 0%.
- *The display unit should be selected with C58.

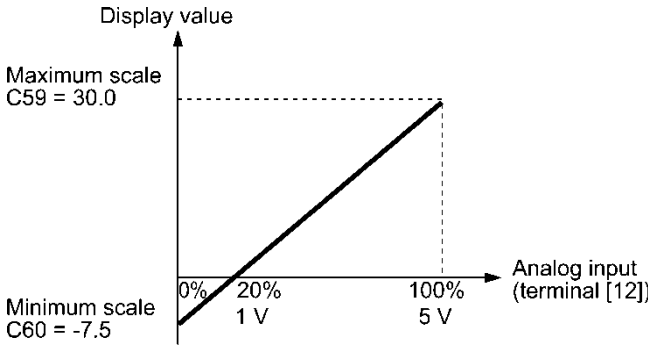

C61	Analog Input Adjustment for Terminal [C1] (Bias value)	(Refer to F01.)
------------	---	------------------------

C61 specifies a bias value to Reference frequency 2 and analog input monitor terminal [C1]. For details, refer to the description of F01.

C62	Analog Input Adjustment for Terminal [C1] (Bias base point)	(Refer to F01.)
------------	--	------------------------

C62 specifies a bias base point for Reference frequency 2 and analog input monitor terminal [C1]. For details, refer to the description of F01.

C64**Analog Input Adjustment for Terminal [C1] (Display unit)**

C64 specifies the display unit for analog input monitor, PID control commands and feedback amounts on terminal [C1].

The specified display unit appears when analog input monitor, SV and PV are displayed on the main or sub monitor.

Data for C64	Display unit	Data for C64	Display unit	Data for C64	Display unit
1	No display unit	24	L/min (Flowrate)	46	Psi (Pressure)
2	%	25	L/h (Flowrate)	47	mWG (Pressure)
4	r/min	40	Pa (Pressure)	48	inWG (Pressure)
7	kW	41	kPa (Pressure)	60	K (Temperature)
20	m ³ /s (Flowrate)	42	MPa (Pressure)	61	°C (Temperature)
21	m ³ /min (Flowrate)	43	mbar (Pressure)	62	°F (Temperature)
22	m ³ /h (Flowrate)	44	bar (Pressure)	80	ppm (Density)
23	L/s (Flowrate)	45	mmHg (Pressure)		

Setting up an analog input monitor for terminal [C1]

1) Input monitor

Set E62 (Terminal [C1] extended function) to "20."

2) Display section

Set any of K10 (Main monitor display), K16 (Sub monitor 1 display) and K17 (Sub monitor 2 display) to "27" (Analog input monitor).

For details, refer to Chapter 5, Section 5.5.1 "Monitoring the running status."

3) Display unit

Select the desired display unit with C64.

4) Scale

- Maximum scale (C65): Set a physical quantity to be displayed when the analog input value is 100%.
- Minimum scale (C66): Set a physical quantity to be displayed when the analog input value is 0%.

C65, C66**Analog Input Adjustment for Terminal [C1] (Maximum scale, Minimum scale)**

C65 and C66 specify the maximum and minimum scales to display easy-to-understand physical quantity converted from analog input on terminal [C1].

- Data setting range: -999.00 to 0.00 to 9990.00 for maximum and minimum scales

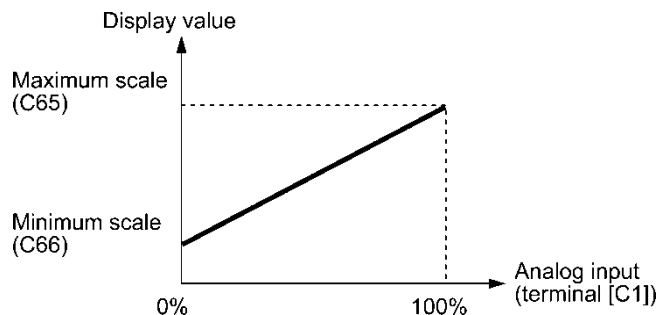

Example: To detect 0 to 30 kPa with 4 to 20 mA output of the pressure sensor

1) Input monitor

Set E62 (Terminal [C1] extended function) to "20."

2) Scale

- Maximum scale (C65): Set 30.0 to be displayed when the analog input value on terminal [C1] is 100%.
- Minimum scale (C66): Set 0 to be displayed when the analog input value on terminal [C1] is 0%.

*The display unit should be selected with C64.

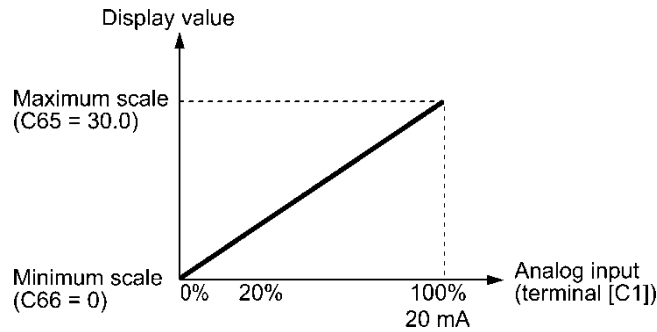
**C67****Analog Input Adjustment for Terminal [V2] (Bias value)****(Refer to F01.)**

C67 specifies a bias value to Reference frequency 2 and analog input monitor terminal [V2]. For details, refer to the description of F01.

C68**Analog Input Adjustment for Terminal [V2] (Bias base point)****(Refer to F01.)**

C68 specifies a bias base point for Reference frequency 2 and analog input monitor terminal [V2]. For details, refer to the description of F01.

C70**Analog Input Adjustment for Terminal [V2] (Display unit)**

C70 specifies the display unit for analog input monitor, PID control commands and feedback amounts on terminal [V2].

The specified display unit appears when analog input monitor, SV and PV are displayed on the main or sub monitor.

Data for C70	Display unit	Data for C70	Display unit	Data for C70	Display unit
1	No display unit	24	L/min (Flowrate)	46	Psi (Pressure)
2	%	25	L/h (Flowrate)	47	mWG (Pressure)
4	r/min	40	Pa (Pressure)	48	inWG (Pressure)
7	kW	41	kPa (Pressure)	60	K (Temperature)
20	m ³ /s (Flowrate)	42	MPa (Pressure)	61	°C (Temperature)
21	m ³ /min (Flowrate)	43	mbar (Pressure)	62	°F (Temperature)
22	m ³ /h (Flowrate)	44	bar (Pressure)	80	ppm (Density)
23	L/s (Flowrate)	45	mmHg (Pressure)		

Setting up an analog input monitor for terminal [V2]

- 1) Input monitor
Set E63 (Terminal [V2] extended function) to "20."
- 2) Display section
Set any of K10 (Main monitor display), K16 (Sub monitor 1 display) and K17 (Sub monitor 2 display) to "27" (Analog input monitor).
For details, refer to Chapter 5, Section 5.5.1 "Monitoring the running status."
- 3) Display unit
Select the desired display unit with C70.
- 4) Scale
 - Maximum scale (C71): Set a physical quantity to be displayed when the analog input value is 100%.
 - Minimum scale (C72): Set a physical quantity to be displayed when the analog input value is 0%.

C71, C72

Analog Input Adjustment for Terminal [V2] (Maximum scale, Minimum scale)

C71 and C72 specify the maximum and minimum scales to display easy-to-understand physical quantity converted from analog input on terminal [V2].

- Data setting range: -999.00 to 0.00 to 9990.00 for maximum and minimum scales

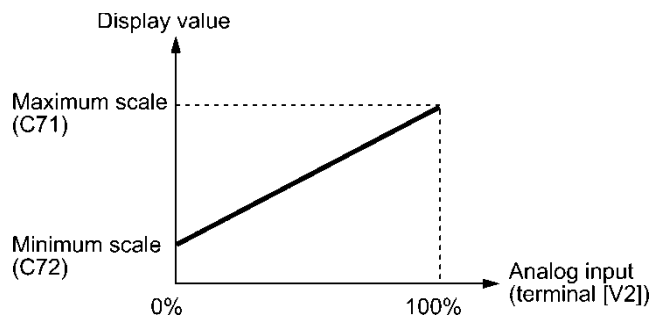

Example: To detect 0 to 30 kPa with 1 to 5 V output of the pressure sensor

- 1) Input monitor
Set E63 (Terminal [V2] extended function) to "20."
- 2) Gain
To interpret 5V as 100%, set the gain to 200% (C32 = 100%, C34 = 50%).
- 3) Scale
 - Maximum scale (C71): Set 30.0 to be displayed when the analog input value on terminal [V2] is 100%.
 - Minimum scale (C72): Set 0 to be displayed when the analog input value on terminal [V2] is 0%.

*The display unit should be selected with C70.

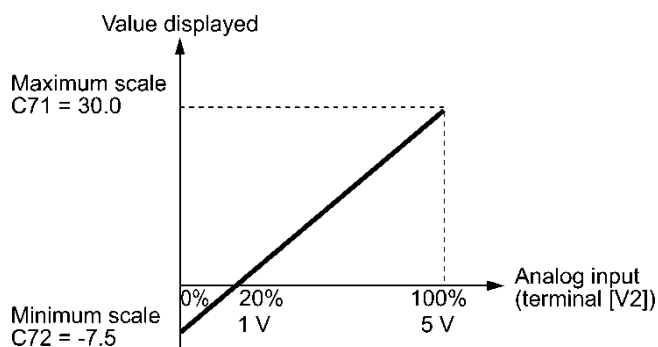

6.3.4 P codes (Motor 1 parameters)

To use the integrated automatic control functions such as auto torque boost, torque calculation monitoring, torque limiter, automatic deceleration (anti-regenerative control), auto search for idling motor speed, slip compensation, and torque vector control, it is necessary to build a motor model in the inverter by specifying proper motor parameters including the motor capacity and rated current.

P01**Motor 1 (No. of poles)**

P01 specifies the number of poles of the motor. Enter the value given on the nameplate of the motor. This setting is used to display the motor speed on the LCD monitor and to control the speed (refer to E43). The following expression is used for the conversion.

$$\text{Motor speed (r/min)} = \frac{120}{\text{No. of poles}} \times \text{Frequency (Hz)}$$

- Data setting range: 2 to 22 (poles)

P02**Motor 1 (Rated capacity)**

P02 specifies the rated capacity of the motor. Enter the rated value given on the nameplate of the motor.

Data for P02	Unit	Dependency on function code P99
0.01 to 1000.00	kW	When P99 (Motor 1 Selection) = 0 or 4
	HP	When P99 (Motor 1 Selection) = 1

When accessing P02 with the keypad, take into account that the P02 data automatically updates data of P03, P06 through P12, and H46.

P03**Motor 1 (Rated current)**

P03 specifies the rated current of the motor. Enter the rated value given on the nameplate of the motor.

- Data setting range: 0.00 to 2000.00 (A)

The inverter automatically detects the motor constants and saves them as parameters in its internal memory. Basically, no tuning is required as long as a Fuji standard motor is used with standard connection with the inverter.

There are two types of auto-tuning as listed below. Select appropriate one considering the limitations in your equipment and control mode.

Data for P04	Auto-tuning	Operation	Motor parameters to be tuned
0	Disable	N/A	N/A
1	Tune the motor while it is stopped	Tunes while the motor is stopped.	Primary resistance (%R1) (P07) Leakage reactance (%X) (P08)
2	Tune the motor while it is rotating under V/f control	After tuning the motor in a stopped state, retunes it running at 50% of the base frequency.	No-load current (P06) Primary resistance (%R1) (P07) Leakage reactance (%X) (P08)

 For details of auto-tuning, refer to the Chapter 5 "Preparation and Test Run."

 **Note** In any of the following cases, perform auto-tuning since the motor parameters are different from standard ones so that the full performance may not be obtained under some controls.

- The motor to be driven is a non-Fuji motor or a non-standard motor.
- Cabling between the motor and the inverter is long. (Generally, 20 m or longer)
- A reactor is inserted between the motor and the inverter.

 **Note** When the terminal command **RST** ("Reset alarm") is ON, it is not possible to change the P04 setting. Turn the **RST** OFF beforehand.

 Refer to E01 to E07, E98 and E99 (data = 8).

■ Functions in which the motor parameters affect the running capability

Function	Related function codes (representative)
Auto torque boost	F37
Output torque monitor	F31, F35
Load factor monitor	F31, F35
Auto energy saving operation	F37
Torque limiter	F40, F41, E16, E17
Anti-regenerative control (Automatic deceleration)	H69
Auto search	H09
Slip compensation	F42
Dynamic torque vector control	F42

P05**Motor 1 (Online tuning)**

Long run under "Dynamic torque vector control" or "Slip compensation control" causes motor temperature change, varying the motor parameters. This changes the motor speed compensation amount, resulting in motor speed deviation from the initial rpm.

Enabling online tuning (P05 = 1) identifies motor parameters covering the motor temperature change to decrease the motor speed fluctuation.

To perform online tuning enabled with P05, set P04 (Auto-tuning) to "2."

 **Note** Online tuning can be performed only when F42 = 1 (Dynamic torque vector control) or when F42 = 2 (V/f control with slip compensation active) and F37 = 2 or 5 (Auto torque boost).

P06 to P08**Motor 1 (No-load current, %R1 and %X)**

P06 through P08 specify no-load current, %R1 and %X, respectively. Obtain the appropriate values from the test report of the motor or by calling the motor manufacturer.

Performing auto-tuning automatically sets these parameters.

■ **No-load current (P06)**

Enter the value obtained from the motor manufacturer.

■ **%R1 (P07)**

Enter the value calculated by the following expression.

$$\%R1 = \frac{R1 + \text{Cable } R1}{V / (\sqrt{3} \times I)} \times 100 (\%)$$

where,

R1: Primary resistance of the motor (Ω)

Cable R1: Resistance of the output cable (Ω)

V: Rated voltage of the motor (V)

I: Rated current of the motor (A)

■ **%X (P08)**

Enter the value calculated by the following expression.

$$\%X = \frac{X1 + X2 \times XM / (X2 + XM) + \text{Cable } X}{V / (\sqrt{3} \times I)} \times 100 (\%)$$

where,

X1: Primary leakage reactance of the motor (Ω)

X2: Secondary leakage reactance of the motor (converted to primary) (Ω)

XM: Exciting reactance of the motor (Ω)

Cable X: Reactance of the output cable (Ω)

V: Rated voltage of the motor (V)

I: Rated current of the motor (A)

 **Note** For reactance, use the value at the base frequency (F04).

P10**Motor 1 (Slip compensation response time)**

P10 determines the response time for slip compensation. Basically, there is no need to modify the default setting. If you need to modify it, consult your Fuji Electric representatives.

 For details about slip compensation control, refer to the description of F42.

P12**Motor 1 (Rated slip frequency)**

P12 specifies rated slip frequency. Obtain the appropriate values from the test report of the motor or by calling the manufacturer of the motor.

- Rated slip frequency: Convert the value obtained from the motor manufacturer to Hz using the following expression and enter the converted value.

(Note: The motor rating given on the nameplate sometimes shows a larger value.)

$$\text{Rated slip frequency (Hz)} = \frac{(\text{Synchronous speed} - \text{Rated speed})}{\text{Synchronous speed}} \times \text{Base frequency}$$

 For details about slip compensation control, refer to the description of F42.

P99**Motor 1 Selection**

P99 specifies the type of motor 1 to be used.

Data for P99	Motor type
0	Motor characteristics 0 (Fuji standard motors, 8-series)
1	Motor characteristics 1 (HP rating motors)
4	Other motors

To select the motor drive control or to run the inverter with the integrated automatic control functions such as auto torque boost and torque calculation monitoring, it is necessary to specify the motor parameters correctly.

First select the Fuji standard motors 8-series with P99, next specify the motor rated capacity with P02, and then initialize the motor parameters with H03. This process automatically configures the related motor parameters (P01, P03, P06 through P08, P10, P12, and H46).

The data of F09 (Torque boost 1), H13 (Restart Mode after Momentary Power Failure (Restart time)), and F11 (Electronic thermal overload protection for motor 1 (Overload detection level)) depends on the motor capacity, but the process stated above does not change them. Specify and adjust the data during a test run if needed.

6.3.5 H codes (High performance functions)

H03	Data Initialization
-----	---------------------

This code initializes the current function code data to the factory defaults. To change function code H03 data, it is necessary to press (STOP) + (▲) keys or (STOP) + (▼) keys (simultaneous keying).

Data for H03	Function
0	Disable initialization (Settings manually made by the user will be retained.)
1	Initialize all function code data to factory defaults
2	Initialize motor 1 parameters in accordance with P02 (Rated capacity) and P99 (Motor 1 selection)
10	Initialize real-time clock information
11	Initialize function code data except communication function codes
12	Initialize U codes (Customizable logic function codes)
71	Initialize according to application (Compressor)
72	Initialize according to application (Fan)
73	Initialize according to application (Single pump)

■ Initialize all function code data to factory defaults (H03 = 1)

Initialize all function code data to the factory defaults.

■ Initialize motor 1 parameters (H03 = 2)

Set function codes as follows.

- (1) Function code P99 (motor 1 selection): Selects the motor type.
- (2) Function code P02 (motor 1 (capacity): Sets the motor capacity (kW).
- (3) Function code H03 (data initialization): H03 = 2

⇒ Function codes to be initialized: P01, P03, P06 to P12, H46

- Upon completion of the initialization, the H03 data reverts to "0" (factory default).
- If function code P02 data is set to a value other than the standard nominal applied motor rating, data initialization internally converts the specified value forcibly to the standard nominal applied motor rating. (See Table B given on the last page in Section 6.1 "Function Code Tables.")
- The motor parameters to be initialized are those regarding the voltage and frequency settings below. When the base frequency, rated voltage, and the number of poles are different from those of the listed motors, or when non-Fuji motors or non-standard motors are used, change the rated current data to that printed on the motor nameplate.

Motor selection		V/f setting
Data = 0 or 4	Fuji standard motors, 8-series	4 poles 400 V/50 Hz
Data = 1	HP rating motors	4 poles 230/460/575 V/60 Hz

 When accessing function code P02 with the keypad, take into account that P02 data automatically updates data of function codes P03, P06 through P12, and H46.

■ Initialize real-time clock information (H03 = 10)

Initializes the real-time clock (RTC) information set by $\text{PRG} > 1(\text{Start-up}) > 2(\text{Date/Time}) > 1(\text{Adjust})$.

■ Initialize function code data except communication function codes (H03 = 11)

The function codes other than the communication function codes (y codes) are initialized.

■ Initialize U code data (H03 = 12)

Initializes the customizable logic (U code) data. Any other function code data are not initialized.



■ Initialize according to application (H03 = 71, 72, 73)

H03 initializes data of the specified function codes to the values required for application such as drive control and control objects. Function codes for quick setup also change according to application.

This application-specific initialization is convenient for pump control.

H03 initializes data of function codes not listed below will be initialized to the factory defaults.

When H03 = 71 (Initialize according to application (Compressor))

Object function codes	Initialize to:
F02: Operation Method	1: External signals (Terminal command FWD or REV)
F14: Restart Mode after Momentary Power Failure (Mode selection)	3: Continue to run, for heavy inertia or general loads
F15: Frequency Limiter (High)	50.0 Hz
F16: Frequency Limiter (Low)	25.0 Hz
F26: Motor Sound (Carrier frequency)	3 kHz
F35: Pulse Output [FM2] (Function)	2: Output current
F42: Drive Control Selection 1	1: Dynamic torque vector control
E06: Terminal [X6] Function	171: PID multistep command 1 (PID-SS1)
E07: Terminal [X7] Function	172: PID multistep command 2 (PID-SS2)
E62: Terminal [C1] Extended Function	5: PID feedback value 1
E63: Terminal [V2] Extended Function	32: Auxiliary input 2 to PID process command
C64: Analog Input Adjustment for Terminal [C1] (Display unit)	44: bar
C65: Analog Input Adjustment for Terminal [C1] (Maximum scale)	10.00
H09: Starting Mode (Auto search)	2: Enable (At restart after momentary power failure and at normal start)
H91: Current Input Wire Break Detection	0.5 s
J101: PID Control 1 (Mode selection)	1: Enable (Process control, normal operation)
J110: PID Control 1 P (Gain)	2.500 times
J111: PID Control 1 I (Integral time)	0.2 s
K10: Main Monitor (Display item selection)	51: PID feedback amount (final) in physical quantity
K16: Sub Monitor 1 (Display item selection)	50: PID command (final) in physical quantity
K17: Sub Monitor 2 (Display item selection)	1: Output frequency 1 (before slip compensation)
K91: Shortcut Key Function for  in Running Mode (Jump-to screen)	61: Tools - PID Monitor (PID monitor)
K92: Shortcut Key Function for  in Running Mode (Jump-to screen)	32: INV Infor - Op Monitor (Operation monitor)

When H03 = 72 (Initialize according to application (Fan))

Object function codes	Initialize to:
F02: Operation Method	1: External signals (Terminal command FWD or REV)
F14: Restart Mode after Momentary Power Failure (Mode selection)	3: Continue to run, for heavy inertia or general loads
F15: Frequency Limiter (High)	50.0 Hz
F16: Frequency Limiter (Low)	20.0 Hz
F26: Motor Sound (Carrier frequency)	3 kHz
F35: Pulse Output [FM2] (Function)	2: Output current
F37: Load Selection	3: Auto energy saving (Variable torque load during ACC/DEC)
F42: Drive Control Selection 1	1: Dynamic torque vector control
H09: Starting Mode (Auto search)	2: Enable (At restart after momentary power failure and at normal start)
H69: Automatic Deceleration (Mode selection)	5: DC link bus voltage control with Force-to-stop disabled
H71: Deceleration Characteristics	1: Enable
K91: Shortcut Key Function for \odot in Running Mode (Jump-to screen)	61: Tools - PID Monitor (PID monitor)
K92: Shortcut Key Function for \odot in Running Mode (Jump-to screen)	32: INV Infor - Op Monitor (Operation monitor)

When H03 = 73 (Initialize according to application (Single pump))

Object function codes	Initialize to:
F02: Operation Method	1: External signals (Terminal command FWD or REV)
F07: Acceleration Time 1	3.00 s
F08: Deceleration Time 1	3.00 s
F15: Frequency Limiter (High)	50.0 Hz
F16: Frequency Limiter (Low)	25.0 Hz
F26: Motor Sound (Carrier frequency)	3 kHz
F35: Pulse Output [FM2] (Function)	2: Output current
F37: Load Selection	0: Variable torque load
E06: Terminal [X6] Function	171: PID multistep command 1 (PID-SS1)
E07: Terminal [X7] Function	172: PID multistep command 2 (PID-SS2)
E62: Terminal [C1] Extended Function	5: PID feedback value 1
E63: Terminal [V2] Extended Function	32: Auxiliary input 2 to PID process command
C64: Analog Input Adjustment for Terminal [C1] (Display unit)	44: bar
C65: Analog Input Adjustment for Terminal [C1] (Maximum scale)	10.00
H91: Current Input Wire Break Detection	0.5 s
J101: PID Control 1 (Mode selection)	1: Enable (Process control, normal operation)
J110: PID Control 1 P (Gain)	2.500 times
J111: PID Control 1 I (Integral time)	0.2 s
J149: Slow Flowrate Stop Function (Mode selection)	1: Manual operation (stop judgment: MV)

When H03 = 73 (Initialize according to application (Single pump)) (continued)

Object function codes	Initialize to:
J150: Slow Flowrate Stop Function (Operation level)	35.00 Hz
J151: Slow Flowrate Stop Function (Elapsed time)	15 s
J157: Slow Flowrate Stop Function (Cancel frequency)	38.0 Hz
J158: Slow Flowrate Stop Function (Cancel deviation level 1)	0.50
J159: Slow Flowrate Stop Function (Cancel delay timer)	1 s
K10: Main Monitor (Display item selection)	51: PID feedback amount (final) in physical quantity
K16: Sub Monitor 1 (Display item selection)	50: PID command (final) in physical quantity
K17: Sub Monitor 2 (Display item selection)	1: Output frequency 1 (before slip compensation)
K91: Shortcut Key Function for \odot in Running Mode (Jump-to screen)	61: Tools - PID Monitor (PID monitor)
K92: Shortcut Key Function for \otimes in Running Mode (Jump-to screen)	32: INV Infor - Op Monitor (Operation monitor)

Function codes for quick setup, subject to application-specific initialization

The table below lists function codes for quick setup which are subject to application-specific initialization.

Y: Target for quick setup

Object function codes	Data for H03		
	71	72	73
F01: Frequency Command 1	Y	Y	Y
F02: Operation Method	Y	Y	Y
F03: Maximum Frequency 1	Y	Y	Y
F04: Base Frequency 1	Y	Y	Y
F05: Rated Voltage at Base Frequency 1	Y	Y	Y
F06: Maximum Output Voltage 1	Y	Y	Y
F07: Acceleration Time 1	Y	Y	Y
F08: Deceleration Time 1	Y	Y	Y
F09: Torque Boost 1	-	-	Y
F14: Restart Mode after Momentary Power Failure (Mode selection)	Y	Y	-
F15: Frequency Limiter (High)	Y	Y	Y
F16: Frequency Limiter (Low)	Y	Y	Y
F35: Pulse Output [FM2] (Function)	Y	Y	Y
F37: Load Selection	Y	Y	Y
C64: Analog Input Adjustment for Terminal [C1] (Display unit)	Y	Y	Y

Object function codes	Data for H03		
	71	72	73
C65: Analog Input Adjustment for Terminal [C1] (Maximum scale)	Y	Y	Y
C66: Analog Input Adjustment for Terminal [C1] (Minimum scale)	Y	Y	Y
P02: Motor 1 (Rated capacity)	Y	Y	-
P03: Motor 1 (Rated current)	Y	Y	-
P04: Motor 1 (Auto-tuning)	Y	Y	-
P99: Motor 1 Selection	Y	Y	-
H09: Starting Mode (Auto search)	Y	Y	-
H69: Automatic Deceleration (Mode selection)	-	Y	-
H71: Deceleration Characteristics	-	Y	-
J102: PID Control 1 (Command selection)	Y	-	Y
J103: PID Control 1 (Feedback selection)	Y	-	Y
J110: PID Control 1 P (Gain)	Y	-	Y
J111: PID Control 1 I (Integral time)	Y	-	Y
J149: Slow Flowrate Stop Function (Mode selection)	-	-	Y
J150: Slow Flowrate Stop Function (Operation level)	-	-	Y
J151: Slow Flowrate Stop Function (Elapsed time)	-	-	Y
J156: Slow Flowrate Stop Function (Initiation inhibition time)	-	-	Y
J157: Slow Flowrate Stop Function (Cancel frequency)	-	-	Y
J158: Slow Flowrate Stop Function (Cancel deviation level 1)	-	-	Y
J159: Slow Flowrate Stop Function (Cancel delay timer)	-	-	Y
J160: Slow Flowrate Stop Function (Cancel deviation level 2)	-	-	Y
K10: Main Monitor (Display item selection)	Y	Y	Y
K16: Sub Monitor 1 (Display item selection)	Y	Y	Y
K17: Sub Monitor 2 (Display item selection)	Y	Y	Y
K91: Shortcut Key Function for Ⓞ in Running Mode (Jump-to screen)	Y	Y	Y
K92: Shortcut Key Function for Ⓟ in Running Mode (Jump-to screen)	Y	Y	Y

*Function codes other than the above are not available for quick setup.

H04, H05**Auto-reset (Times and Reset interval)**

H04 and H05 specify the auto-reset function that makes the inverter automatically attempt to reset the tripped state and restart without issuing an alarm output (for any alarm) even if any protective function subject to reset is activated and the inverter enters the forced-to-stop state (tripped state).

If the protective function is activated in excess of the times specified by H04, the inverter will issue an alarm output (for any alarm) and not attempt to auto-reset the tripped state.

Listed below are the protective functions subject to auto-reset.

Protective function	Alarm codes	Protective function	Alarm codes
Overcurrent protection	OC1, OC2 or OC3	Undervoltage	LV
Overvoltage protection	OV1, OV2 or OV3	Motor overheat	OH4
Heat sink overheat	OH1	External alarm	OH2
Inverter internal overheat	OH3	Motor overload	OL1
Inverter overload	OLU		

■ Number of reset times (H04)

H04 specifies the number of reset times for the inverter to automatically attempt to escape the tripped state. When H04 = 0, the auto-reset function will not be activated.

- Data setting range: OFF (Disable), 1 to 20 (times)

⚠ WARNING

If the "auto-reset" function has been specified, the inverter may automatically restart and run the motor stopped due to a trip fault, depending on the cause of the tripping.

Design the machinery so that human body and peripheral equipment safety is ensured even when the auto-resetting succeeds.

Otherwise an accident could occur.

■ Reset interval (H05)

- Data setting range: 0.5 to 600.0 (s)

H05 specifies the reset interval time from when the inverter enters the tripped state until it issues the reset command to attempt to auto-reset the state. Refer to the timing scheme diagrams below.

<Operation timing scheme>

- In the figure below, normal operation restarts in the 4th retry.

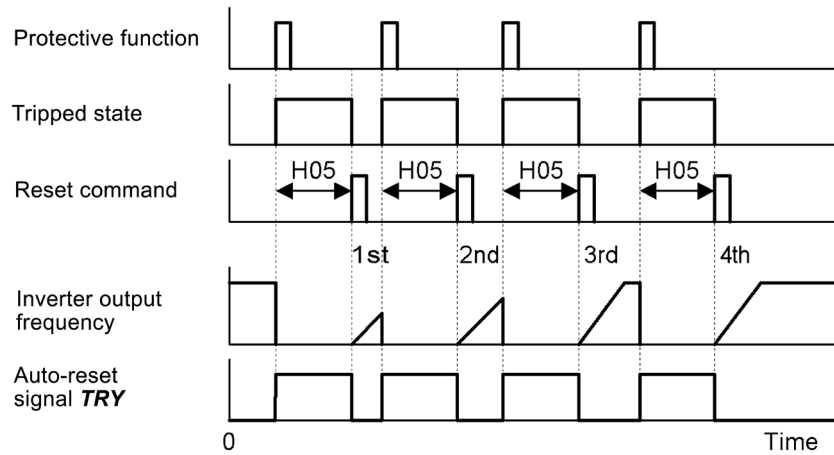

- In the figure below, the inverter fails to restart normal operation within the number of reset times specified by $H04$ (in this case, 3 times ($H04 = 3$)), and issues the alarm output (for any alarm) *ALM*.

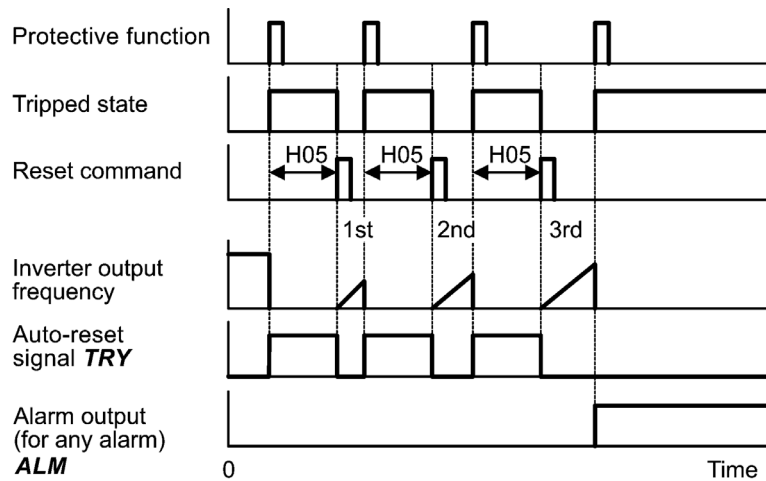

The auto-reset operation can be monitored from the external equipment by assigning the digital output signal *TRY* to any of the programmable, output terminals [Y1] to [Y4], [Y5A/C], and [30A/B/C] with any of E20 through E24 and E27 (data = 26).

H06	Cooling Fan ON/OFF Control
------------	-----------------------------------

To prolong the service life of the cooling fan and reduce fan noise during running, the cooling fan stops when the temperature inside the inverter drops below a certain level while the inverter stops.

H06 specifies whether to keep running the cooling fan all the time or to control its ON/OFF.

Data for H06	Cooling fan ON/OFF
0	Disable (Always in operation)
1	Enable (ON/OFF controllable)

■ Cooling fan in operation -- **FAN** (E20 to E24 and E27, data = 25)

With the cooling fan ON/OFF control enabled (H06 = 1), this output signal is ON when the cooling fan is in operation, and OFF when it is stopped. This signal can be used to make the cooling system of peripheral equipment interlocked for an ON/OFF control

H07	Acceleration/Deceleration Pattern	(Refer to F07.)
------------	--	------------------------

For details, refer to the description of F07.

H08	Rotational Direction Limitation
------------	--

H08 inhibits the motor from running in an unexpected rotational direction due to miss-operation of run commands, miss-polarization of frequency commands, or other mistakes.

Data for H08	Function
0	Disable
1	Enable (Reverse rotation inhibited, both of setting and output)
2	Enable (Forward rotation inhibited, both of setting and output)
3	Enable (Reverse rotation inhibited, setting only)
4	Enable (Forward rotation inhibited, setting only)

H09	Starting Mode (Auto search)	H49 (Starting Mode, Auto search delay time 1) H46 (Starting Mode, Auto search delay time 2)
------------	------------------------------------	--

H09 specifies the starting mode--whether to enable the auto search for idling motor speed to run the idling motor without stopping it.

The auto search can apply to the restart of the inverter after a momentary power failure and the normal startup of the inverter individually.

If the terminal command **STM** ("Enable auto search for idling motor speed at starting") is assigned to a digital input terminal with any of E01 to E07 (data = 26), then the combination of the H09 data and the **STM** status switches the starting modes (whether auto search is enabled or disabled). If no **STM** is assigned, the inverter interprets **STM** as being OFF by default.

■ H09 (Starting mode, auto search) and terminal command **STM**
("Enable auto search for idling motor speed at starting")

The combination of H09 data and the **STM** status determines whether to perform auto search as listed below.

STM	Data for H09	Auto search for idling motor speed at starting	
		For restart after momentary power failure (F14 = 3 to 5)	For normal startup
OFF	0: Disable	Disable	Disable
	1: Enable	Enable	Disable
	2: Enable	Enable	Enable
ON	—	Enable	Enable

When **STM** is ON, auto search for idling motor speed at starting is enabled regardless of the H09/d67 setting. Refer to E01 to E07 (data = 26).

Auto search for idling motor speed

Starting the inverter (with a run command ON, **BX** OFF, auto-reset, etc.) with **STM** being ON searches for the idling motor speed for a maximum of 1.2 seconds to run the idling motor without stopping it. After completion of the auto search, the inverter accelerates the motor up to the reference frequency according to the frequency command and the preset acceleration time.

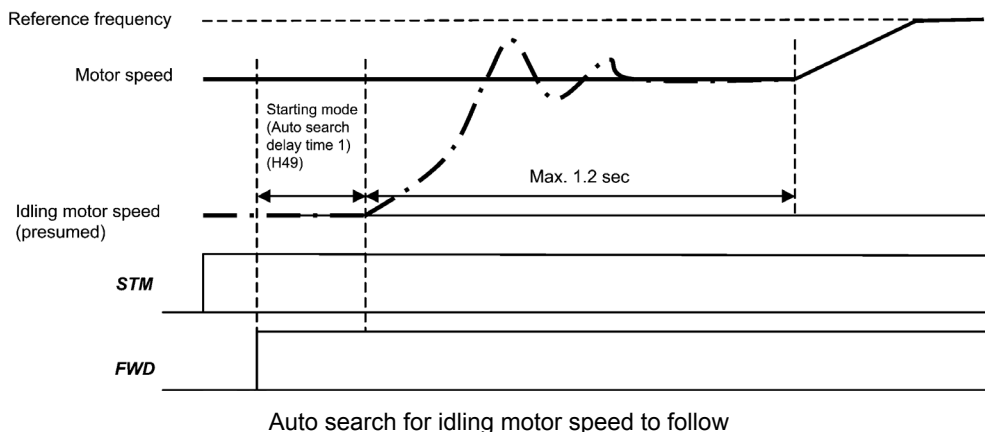

■ Starting Mode (Auto search delay time 1) (H49)

- Data setting range: 0.0 to 10.0 (s)

Auto search for the idling motor speed will become unsuccessful if it is done while the motor retains residual voltage. It is, therefore, necessary to leave the motor for an enough time for residual voltage to disappear. H49 specifies that time (0.0 to 10.0 sec.).

At the startup triggered by a run command ON, auto search starts with the delay specified by H49. Using H49, therefore, eliminates the need of the run command timing control when two inverters drive a single motor alternately, allow the motor to coast to a stop, and restart it under auto search control at each time of inverter switching.

■ Starting Mode (Auto search delay time 2) (H46)

- Data setting range: 0.0 to 10.0 (s) (ROM version earlier than 2000)
0.0 to 20.0 (s) (ROM version 2000 or later)

At the restart after a momentary power failure, at the start by turning the terminal command **BX** ("Coast to a stop") OFF and ON, or at the restart by auto-reset, the inverter applies the delay time specified by H46. The inverter will not start unless the time specified by H46 has elapsed, even if the starting conditions are satisfied.

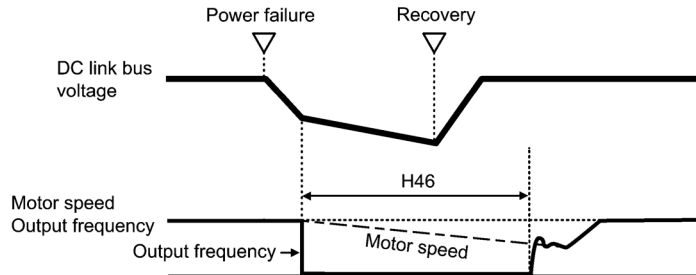

Under auto search control, the inverter searches the motor speed with the voltage applied at the motor start and the current flowing in the motor, based on the model built with the motor parameters. Therefore, the search is greatly influenced by the residual voltage in the motor.

H46 is available for motor 1 only.

At factory shipment, H46 data is preset to a correct value according to the motor capacity for the general-purpose motor, and basically there is no need to modify the data.

Depending on the motor characteristics, however, it may take time for residual voltage to disappear (due to the secondary thermal time constant of the motor). In such a case, the inverter starts the motor with the residual voltage remaining, which will cause an error in the speed search and may result in occurrence of an inrush current or an overvoltage alarm.

If it happens, increase the value of H46 data and remove the influence of residual voltage. (If possible, it is recommended to set the value around two times as large as the factory default value allowing a margin.)



- Be sure to auto-tune the inverter preceding the start of auto search for the idling motor speed.
- When the estimated speed exceeds the maximum frequency or the upper limit frequency, the inverter disables auto search and starts running the motor with the maximum frequency or the upper limit frequency, whichever is lower.
- During auto search, if an overcurrent or overvoltage trip occurs, the inverter restarts the suspended auto search.
- Perform auto search at 60 Hz or below.
- Note that auto search may not fully provide the performance depending on load conditions, motor parameters, wiring length, and other external factors.

H11	Deceleration Mode
------------	--------------------------

H11 specifies the deceleration mode to be applied when a run command is turned OFF.

Data for H11	Function
0	Normal deceleration
1	Coast-to-stop The inverter immediately shuts down its output, so the motor stops according to the inertia of the motor and machinery (load) and their kinetic energy losses.

 When reducing the reference frequency, the inverter decelerates the motor according to the deceleration commands even if H11 = 1 (Coast-to-stop).

H12	Instantaneous Overcurrent Limiting (Mode selection)	(Refer to F43.)
------------	--	------------------------

Refer to the descriptions of F43 and F44.

H13, H14 H15, H16	Restart Mode after Momentary Power Failure (Restart time, Frequency fall rate, Continuous running level, and Allowable momentary power failure time)	(Refer to F14.)
------------------------------	---	------------------------

For how to set these function codes (Restart time, Frequency fall rate, Continuous running level and Allowable momentary power failure time), refer to the description of F14.

H26, H27	Thermistor (for motor) (Mode selection and Level)
-----------------	--

These function codes specify the PTC (Positive Temperature Coefficient) thermistor embedded in the motor. The thermistor is used to protect the motor from overheating or output an alarm signal.

■ Thermistor (for motor) (Mode selection) (H26)

H26 selects the function operation mode (protection or alarm) for the PTC thermistor as shown below.

Data for H26	Action
0	Disable
1	Enable When the voltage sensed by PTC thermistor exceeds the detection level, the motor protective function (alarm OH4) is triggered, causing the inverter to enter an alarm stop state.
2	Enable When the voltage sensed by the PTC thermistor exceeds the detection level, a motor alarm signal is output but the inverter continues running. You need to assign the "Motor overheat detected by thermistor" signal (<i>THM</i>) to one of the digital output terminals beforehand, by which a temperature alarm condition can be detected by the thermistor (PTC) (E20 to E24 and E27, data = 56).

■ Thermistor (for motor) (Level) (H27)

H27 specifies the detection level (expressed in voltage) for the temperature sensed by the PTC thermistor.

- Data setting range: 0.00 to 5.00 (V)

The alarm temperature at which the overheat protection becomes activated depends on the characteristics of the PTC thermistor. The internal resistance of the thermistor will significantly change at the alarm temperature. The detection level (voltage) is specified based on the change of the internal resistance.

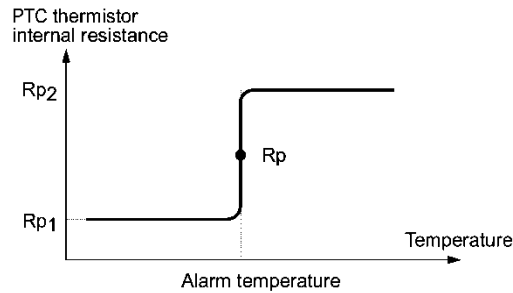

Suppose that the internal resistance of the PTC thermistor at the alarm temperature is Rp, the detection level (voltage) V_{v2} is calculated by the expression below. Set the result V_{v2} to function code H27.

$$V_{v2} = \frac{R_p}{27000 + R_p} \times 10.5 \text{ (V)}$$

Connect the PTC thermistor as shown below. The voltage obtained by dividing the input voltage on terminal [C1] with a set of internal resistors is compared with the detection level voltage specified by H27.

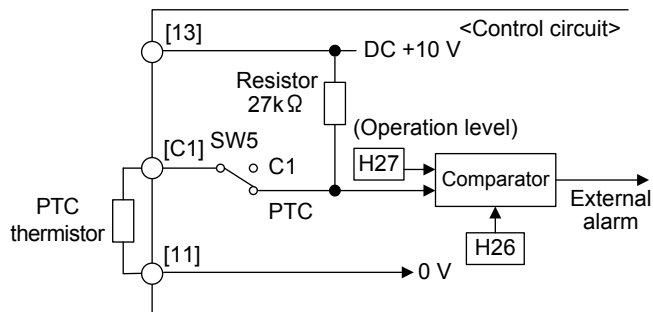

Note When using the terminal [C1] for PTC thermistor input, also turn SW5 on the control printed circuit board to the PTC side. For details, refer to Chapter 2, "SPECIFICATIONS."

H30	Communications Link Function (Mode selection) y98 (Bus Link Function, Mode selection)
------------	--

Using the RS-485 communications link (standard/option) or fieldbus (option) allows you to issue frequency commands and run commands from a computer or PLC at a remote location, as well as monitor the inverter running information and the function code data.

H30 and y98 specify the sources of those commands--"inverter itself" or "computers or PLCs via the RS-485 communications link or fieldbus." H30 is for the RS-485 communications link; y98 for the fieldbus.

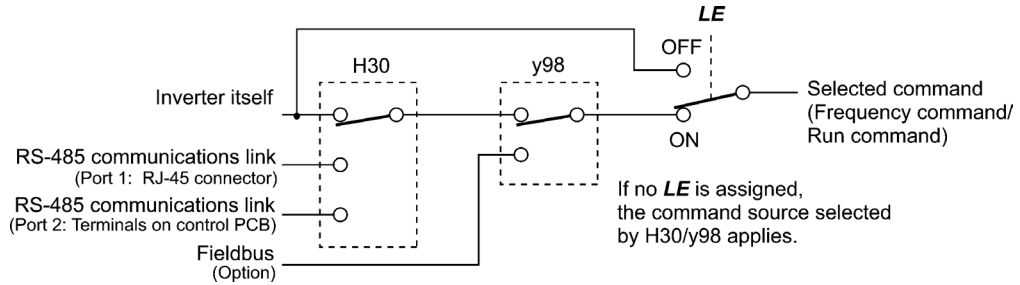

Command sources selectable

Command sources	Description
Inverter itself	Sources except RS-485 communications link and fieldbus Frequency command source: Specified by F01/C30, or multistep frequency command Run command source: Via the keypad or digital input terminals selected by F02
RS-485 communications link (port 1)	Via the standard RJ-45 port used for connecting a keypad
RS-485 communications link (port 2)	Via the terminals DX+, DX- and SD on the control PCB
Fieldbus (option)	Via fieldbus (option) using FA protocol such as DeviceNet or PROFIBUS DP

Command sources specified by H30 (Communications link function, Mode selection)

Data for H30	Frequency command	Run command
0	Inverter unit (F01/C30)	Inverter unit (F02)
1	RS-485 communications link (port 1)	Inverter unit (F02)
2	Inverter unit (F01/C30)	RS-485 communications link (port 1)
3	RS-485 communications link (port 1)	RS-485 communications link (port 1)
4	RS-485 communications link (port 2)	Inverter unit (F02)
5	RS-485 communications link (port 2)	RS-485 communications link (port 1)
6	Inverter unit (F01/C30)	RS-485 communications link (port 2)
7	RS-485 communications link (port 1)	RS-485 communications link (port 2)
8	RS-485 communications link (port 2)	RS-485 communications link (port 2)

Note Run commands contain digital input via terminals [X1] to [X7] in addition to **FWD** and **REV** via terminals [FWD] and [REV]. No concurrent run command input from the inverter unit (**FWD/REV**) and the RS-485 communications link (digital input via [X1] to [X7]) is possible.

Command sources specified by y98 (Bus link function, Mode selection)

Data for y98	Frequency command	Run command
0	Follow H30 data	Follow H30 data
1	Via fieldbus (option)	Follow H30 data
2	Follow H30 data	Via fieldbus (option)
3	Via fieldbus (option)	Via fieldbus (option)

Combination of command sources

		Frequency command			
		Inverter itself	Via RS-485 communications link (port 1)	Via RS-485 communications link (port 2)	Via fieldbus (option)
Run command source	Inverter itself	H30 = 0 y98 = 0	H30 = 1 y98 = 0	H30=4 y98=0	H30=0 (1 or 4) y98=1
	Via RS-485 communications link (port 1)	H30 = 2 y98 = 0	H30 = 3 y98 = 0	H30=5 y98=0	H30=2 (3 or 5) y98=1
	Via RS-485 communications link (port 2)	H30 = 6 y98 = 0	H30 = 7 y98 = 0	H30=8 y98=0	H30=6 (7 or 8) y98=1
	Via fieldbus (option)	H30 = 0 (2 or 6) y98 = 2	H30 = 1 (3 or 7) y98 = 2	H30 = 4 (5 or 8) y98 = 2	H30 = 0 (1 to 8) y98 = 3

 For details, refer to the RS-485 Communication User's Manual or the Field Bus Option Instruction Manual.

- When the terminal command **LE** ("Enable communications link via RS-485 or fieldbus") is assigned to a digital input terminal, turning **LE** ON makes the settings of H30 and y98 enabled. When **LE** is OFF, those settings are disabled so that both frequency commands and run commands specified from the inverter itself take control.

(Refer to the descriptions of E01 through E07, data = 24.)

No **LE** assignment is functionally equivalent to the **LE** being ON.

H42, H43
H48

**Capacitance of DC Link Bus Capacitor, Cumulative Run Time of Cooling Fan
Cumulative Run Time of Capacitors on Printed Circuit Boards**
H47 (Initial Capacitance of DC Link Bus Capacitor)
H98 (Protection/Maintenance Function)

■ Life prediction function

The inverter has the life prediction function for some parts which measures the discharging time or counts the voltage applied time, etc. The function allows you to monitor the current lifetime state on the LCD monitor and judge whether those parts are approaching the end of their service life.

The life prediction function can also issue early warning signals if the lifetime alarm command **LIFE** is assigned to any of the digital output terminals by any of E20 through E24 and E27.

The predicted values should be used only as a guide since the actual service life is influenced by the ambient temperature and other usage environments.

Object of life prediction	Prediction function	End-of-life criteria	Prediction timing	On the LCD monitor
DC link bus capacitor	<u>Measurement of discharging time</u> Measures the discharging time of the DC link bus capacitor when the main power is shut down and calculates the capacitance.	85% or lower of the initial capacitance at shipment (See "[1] Measuring the capacitance of DC link bus capacitor in comparison with initial one at shipment" on the next page.)	At periodic inspection (H98: Bit 3 = 0)	PRG > 3 > 4[2/7] 3. Inverter information 4. Maintenance information (2 of 7 page) ⇒ Cap (capacity)
		85% or lower of the reference capacitance under ordinary operating conditions at the user site (See "[2] Measuring the capacitance of DC link bus capacitor under ordinary operating conditions" given later.)	During ordinary operation (H98: Bit 3 = 1)	
	<u>ON-time counting</u> Counts the time elapsed when the voltage is applied to the DC link bus capacitor, while correcting it according to the capacitance measured above.	Exceeding 43,500 hours (five years) For inverters of 150 HP or above: Exceeding 87,000 hours (10 years)	During ordinary operation	PRG > 3 > 4[2/7] 3. Inverter information 4. Maintenance information (2 of 7 page) ⇒ Enet (Energization period) ⇒ Remt (Remaining time)
Electrolytic capacitors on printed circuit boards	Counts the time elapsed when the voltage is applied to the capacitors, while correcting it according to the ambient temperature.	Exceeding 43,500 hours (five years) For inverters of 150 HP or above: Exceeding 87,000 hours (10 years)	During ordinary operation	PRG > 3 > 4[3/7] 3. Inverter information 4. Maintenance information (3 of 7 page) ⇒ Enet (Energization period)
Cooling fans	Counts the run time of the cooling fans.	Exceeding 43,500 hours (five years) For inverters of 150 HP or above: Exceeding 87,000 hours (10 years)	During ordinary operation	⇒ Life (Indication of life)

■ Capacitance measurement of DC link bus capacitor (H42)

Calculating the capacitance of DC link bus capacitor

- The discharging time of the DC link bus capacitor depends largely on the inverter's internal load conditions, e.g. options attached or ON/OFF of digital I/O signals. If actual load conditions are so different from the ones at which the initial/reference capacitance is measured that the measurement result falls out of the accuracy level required, then the inverter does not perform measuring.
- The capacitance measuring conditions at shipment are extremely restricted, e.g., all input terminals being OFF in order to stabilize the load and measure the capacitance accurately. Those conditions are, therefore, different from the actual operating conditions in almost all cases. If the actual operating conditions are the same as those at shipment, shutting down the inverter power automatically measures the discharging time; however, if they are different, no automatic measurement is performed. To perform it, put those conditions back to the factory default ones and shut down the inverter. For the measuring procedure, see [1] given below.
- To measure the capacitance of the DC link bus capacitor *under ordinary operating conditions* when the power is turned OFF, it is necessary to set up the load conditions for ordinary operation and measure the reference capacitance (initial setting) when the inverter is introduced. For the reference capacitance setup procedure, see [2] on the next page. Performing the setup procedure automatically detects and saves the measuring conditions of the DC link bus capacitor.

Setting bit 3 of H98 data to 0 restores the inverter to the measurement in comparison with the initial capacitance measured at shipment.

 **Note** When the inverter uses an auxiliary control power input, the load conditions widely differ so that the discharging time cannot be accurately measured. In this case, measuring of the discharging time can be disabled with the function code H98 (Bit 4 = 0) for preventing unintended measuring.

ON-time counting of DC link bus capacitor

- In a machine system where the inverter main power is rarely shut down, the inverter does not measure the discharging time. For such an inverter, the ON-time counting is provided. If the capacitance measurement is made, the inverter corrects the ON-time according to the capacitance measured.

The ON-time counting result can be represented as "elapsed time" and "remaining time before the end of life."

[1] Measuring the capacitance of DC link bus capacitor in comparison with initial one at shipment

When bit 3 of H98 data is 0, the measuring procedure given below measures the capacitance of DC link bus capacitor in comparison with initial one at shipment when the power is turned OFF. The measuring result can be displayed on the keypad as a ratio (%) to the initial capacitance.

----- Capacitance measuring procedure -----

- 1) To ensure validity in the comparative measurement, put the condition of the inverter back to the state at factory shipment.
 - Remove the option card (if already in use) from the inverter.
 - In case another inverter is connected via the DC link bus to the P(+) and N(-) terminals of the main circuit, disconnect the wires. (You do not need to disconnect a DC reactor (optional), if any.)
 - Disconnect power wires for the auxiliary input to the control circuit (R0, T0).
 - Turn OFF all the digital input signals fed to terminals [FWD], [REV], and [X1] through [X7] of the control circuit.
 - If a potentiometer is connected to terminal [13], disconnect it.
 - If an external apparatus is attached to terminal [PLC], disconnect it.

- Ensure that transistor output signals ([Y1] to [Y4]) and relay output signals ([Y5A] - [Y5C], and [30A/B/C]) will not be turned ON.
- Disable the RS-485 communications link.



If negative logic is specified for the transistor output and relay output signals, they are considered ON when the inverter is not running. Specify positive logic for them.

- Keep the ambient temperature within $25 \pm 10^{\circ}\text{C}$ ($77 \pm 18^{\circ}\text{F}$).
- 2) Turn ON the main circuit power.
 - 3) Confirm that the inverter is in a stopped state.
 - 4) Turn OFF the main circuit power.
 - 5) The inverter automatically starts the measurement of the capacitance of the DC link bus capacitor. Check that "Capacitor capacitance measurement" is shown on the LCD monitor.



In a case where "Capacitor capacitance measurement" is not shown on the LCD monitor, measurement is not yet started.

- 6) After " " has disappeared from the LCD monitor, turn ON the main circuit power again.
- 7) Select `PRG > 3(INV Info) > 4(Maintenance)` in Programming mode and note the reading (relative capacitance (%)) of the DC link bus capacitor.

[2] Measuring the capacitance of DC link bus capacitor under ordinary operating conditions

When bit 3 of H98 data is 1, the inverter automatically measures the capacitance of the DC link bus capacitor under ordinary operating conditions when the power is turned OFF. This measurement requires setting up the load conditions for ordinary operation and measuring the reference capacitance when the inverter is introduced to the practical operation, using the setup procedure given below.

Function code	Name	Data
H42	Capacitance of DC link bus capacitor	<ul style="list-style-type: none"> • Capacitance of DC link bus capacitor (measured value) • Start of initial capacitance measuring mode under ordinary operating conditions (Meas) • Measurement failure (Failed)
H47	Initial capacitance of DC link bus capacitor	<ul style="list-style-type: none"> • Initial capacitance of DC link bus capacitor (measured value) • Start of initial capacitance measuring mode under ordinary operating conditions (Meas) • Measurement failure (Failed)

When replacing parts, clear or modify the H42 and H47 data. For details, refer to the documents for maintenance.

----- Reference capacitance setup procedure -----

- 1) Set function code H98 (Protection/maintenance function) to enable the user to specify the judgment criteria for the service life of the DC link bus capacitor (Bit 3 = 1) (refer to function code H98).
- 2) Turn OFF all run commands.
- 3) Make the inverter ready to be turned OFF under ordinary operating conditions.
- 4) Set both function codes H42 (Capacitance of DC link bus capacitor) and H47 (Initial capacitance of DC link bus capacitor) to "Meas." (Setting H47 to "Meas" automatically sets H42 to "Meas.")

5) Turn OFF the inverter, and the following operations are automatically performed.
 The inverter measures the discharging time of the DC link bus capacitor and saves the result in function code H47 (Initial capacitance of DC link bus capacitor).

The conditions under which the measurement has been conducted will be automatically collected and saved.

During the measurement, "Capacitor capacitance measurement" is shown on the screen of the keypad.

6) Turn ON the inverter again.

Confirm that H42 (Capacitance of DC link bus capacitor) and H47 (Initial capacitance of DC link bus capacitor) hold right values. Select **[PRG > 3(INV Info) > 4(Maintenance)]** in Programming mode and confirm that the relative capacitance (ratio to full capacitance) is 100%.



If the measurement has failed, "Failed" is entered into both H42 and H47. Remove the factor of the failure and conduct the measurement again.

Hereafter, each time the inverter is turned OFF, it automatically measures the discharging time of the DC link bus capacitor if the above conditions are met. Periodically check the relative capacitance of the DC link bus capacitor (%) with **[PRG > 3(INV Info) > 4(Maintenance)]** in Programming mode.



The condition given above tends to produce a rather large measurement error. If this mode gives you a lifetime alarm, set H98 (Protection/maintenance function) back to the default setting (Bit 3 (Select life judgment threshold of DC link bus capacitor) = 0) and conduct the measurement under the condition at the time of factory shipment.

■ Cumulative Run Time of Capacitors on Printed Circuit Boards (H48)

Function code	Name	Description
H48	Cumulative run time of capacitors on printed circuit boards	Displays the cumulative run time of capacitor on the printed circuit board in units of ten hours. • Data setting range: 0 to 9999 (0 to 99990 hours in increments of 10 hours)

When replacing capacitors on printed circuit boards, clearing or modifying H48 data is required. For details, refer to the materials for maintenance.

■ Cumulative Run Time of Cooling Fan (H43)

Function code	Name	Description
H43	Cumulative run time of cooling fan	Displays the cumulative run time of cooling fan in units of ten hours. • Data setting range: 0 to 9999 (0 to 99990 hours in increments of 10 hours)

When replacing the cooling fan, clearing or modifying H43 data is required. For details, refer to the maintenance related documents.

H44	Startup Counter for Motor 1
------------	------------------------------------

H44 counts the number of inverter startups and displays it in decimal format. Check the displayed number on the maintenance screen of the keypad, and use it as a guide for maintenance timing for parts such as belts. To start the counting over again, e.g. after a belt replacement, set the H44 data to "0000."

H45	Mock Alarm	H97 (Clear Alarm Data)
------------	-------------------	-------------------------------

H45 causes the inverter to generate a mock alarm in order to check whether external sequences function correctly at the time of machine setup.

Setting the H45 data to "1" displays mock alarm Err on the LCD monitor. It also issues alarm output (for any alarm) *ALM* (if assigned to a digital output terminal by any of E20 to E24 and E27). (Accessing the H45 data requires simultaneous keying of "STOP" key + "↵" key.) After that, the H45 data automatically reverts to "0," allowing you to reset the alarm.

Just as data (alarm history and relevant information) of those alarms that could occur in running the inverter, the inverter saves mock alarm data, enabling you to confirm the mock alarm status.

To clear the mock alarm data, use H97. (Accessing the H97 data requires simultaneous keying of "STOP" key + "↵" key.) H97 data automatically returns to "0" after clearing the alarm data.

 **Tip** A mock alarm can be issued also by simultaneous keying of "STOP" key + "SET" key on the keypad for 5 seconds or more."

H46	Starting Mode (Auto search delay time 2)	(Refer to H09.)
------------	---	------------------------

For details, refer to the description of H09.

H47, H48	Initial Capacitance of DC Link Bus Capacitor Cumulative Run Time of Capacitors on Printed Circuit Boards	(Refer to H42.)
-----------------	---	------------------------

For details, refer to the description of H42.

H49	Starting Mode (Auto search delay time 1)	(Refer to H09.)
------------	---	------------------------

For details, refer to the description of H09.

H50, H51 H52, H53	Non-linear V/f Pattern 1 (Frequency and Voltage) Non-linear V/f Pattern 2 (Frequency and Voltage)	(Refer to F04.)
------------------------------	--	------------------------

For details, refer to the description of F04.

H56	Deceleration Time for Forced Stop	(Refer to F07.)
------------	--	------------------------

For details, refer to the description of F07.

Terminal commands *UP* ("Increase output frequency") and *DOWN* ("Decrease output frequency") determine the reference frequency by increasing and decreasing the multistep frequency command being selected, respectively.

H61 provides a choice of terminal command *UP/DOWN* operation modes as listed below.

Setting the H61 at "13" or above and turning any of *SSI* to *SS8* ("Select multistep frequency") ON enables "Multistep frequency + *UP/DOWN* control."

When no multistep frequency is selected (that is, when F01/C30 applies except F01/C30 = 7), both *UP* and *DOWN* commands do not take effect.

When "Multistep frequency + *UP/DOWN* control" is enabled, the acceleration/deceleration time 4 specified by E14/E15 applies.

Run command OFF: When the run command is turned OFF, the inverter saves the *UP/DOWN* frequency.

Inverter power OFF: When the power is turned OFF, the inverter saves the *UP/DOWN* frequency.

Multistep frequency switching: When a multistep frequency is entered, the inverter saves the *UP/DOWN* frequency.

Save *UP/DOWN* frequency with respect to each multistep frequency: The inverter saves the *UP/DOWN* frequency with respect to each multistep frequency.

Clear *UP/DOWN* frequency with respect to each multistep frequency: The inverter clears the *UP/DOWN* frequency by an STZ signal with respect to each multistep frequency.

To use the *UP/DOWN* frequency, you need to assign terminal commands *UP* and *DOWN* to general-purpose digital input terminals beforehand (E01 to E07, data = 17, 18)

When H61 = 1, it is necessary to set F01 to "7" (Terminal command *UP/DOWN* control); when H61 ≥ 13, it is not.

H61	<i>UP/DOWN</i> operation modes					
	Multistep frequency + <i>UP/DOWN</i> control	<i>UP/DOWN</i> frequency saving conditions			Save <i>UP/DOWN</i> frequency with respect to each multistep frequency	Clear <i>UP/DOWN</i> frequency with respect to each multistep frequency (STZ signal)
		Run command OFF	Inverter power OFF	Multistep frequency switching		
1	<input type="checkbox"/>	The inverter internally saves the last output frequency applied under <i>UP/DOWN</i> control and applies the held frequency as an initial value at the next restart.				
13	<input checked="" type="checkbox"/>	<input type="checkbox"/>	<input type="checkbox"/>	<input type="checkbox"/>	<input type="checkbox"/>	<input type="checkbox"/>
14		<input checked="" type="checkbox"/>	<input type="checkbox"/>	<input type="checkbox"/>	<input type="checkbox"/>	<input type="checkbox"/>
16		<input checked="" type="checkbox"/>	<input checked="" type="checkbox"/>	<input type="checkbox"/>	<input type="checkbox"/>	<input type="checkbox"/>
23		<input type="checkbox"/>	<input type="checkbox"/>	<input checked="" type="checkbox"/>	<input type="checkbox"/>	<input type="checkbox"/>
24		<input checked="" type="checkbox"/>	<input type="checkbox"/>	<input checked="" type="checkbox"/>	<input type="checkbox"/>	<input type="checkbox"/>
26		<input checked="" type="checkbox"/>	<input checked="" type="checkbox"/>	<input checked="" type="checkbox"/>	<input type="checkbox"/>	<input type="checkbox"/>
53		<input type="checkbox"/>	<input type="checkbox"/>	<input checked="" type="checkbox"/>	<input checked="" type="checkbox"/>	<input type="checkbox"/>
54		<input checked="" type="checkbox"/>	<input type="checkbox"/>	<input checked="" type="checkbox"/>	<input checked="" type="checkbox"/>	<input type="checkbox"/>
56		<input checked="" type="checkbox"/>	<input checked="" type="checkbox"/>	<input checked="" type="checkbox"/>	<input checked="" type="checkbox"/>	<input type="checkbox"/>
103		<input type="checkbox"/>	<input type="checkbox"/>	<input checked="" type="checkbox"/>	<input checked="" type="checkbox"/>	<input checked="" type="checkbox"/>
104		<input checked="" type="checkbox"/>	<input type="checkbox"/>	<input checked="" type="checkbox"/>	<input checked="" type="checkbox"/>	<input checked="" type="checkbox"/>
106		<input checked="" type="checkbox"/>	<input checked="" type="checkbox"/>	<input checked="" type="checkbox"/>	<input checked="" type="checkbox"/>	<input checked="" type="checkbox"/>

: Active, : Inactive

When H61 = 26

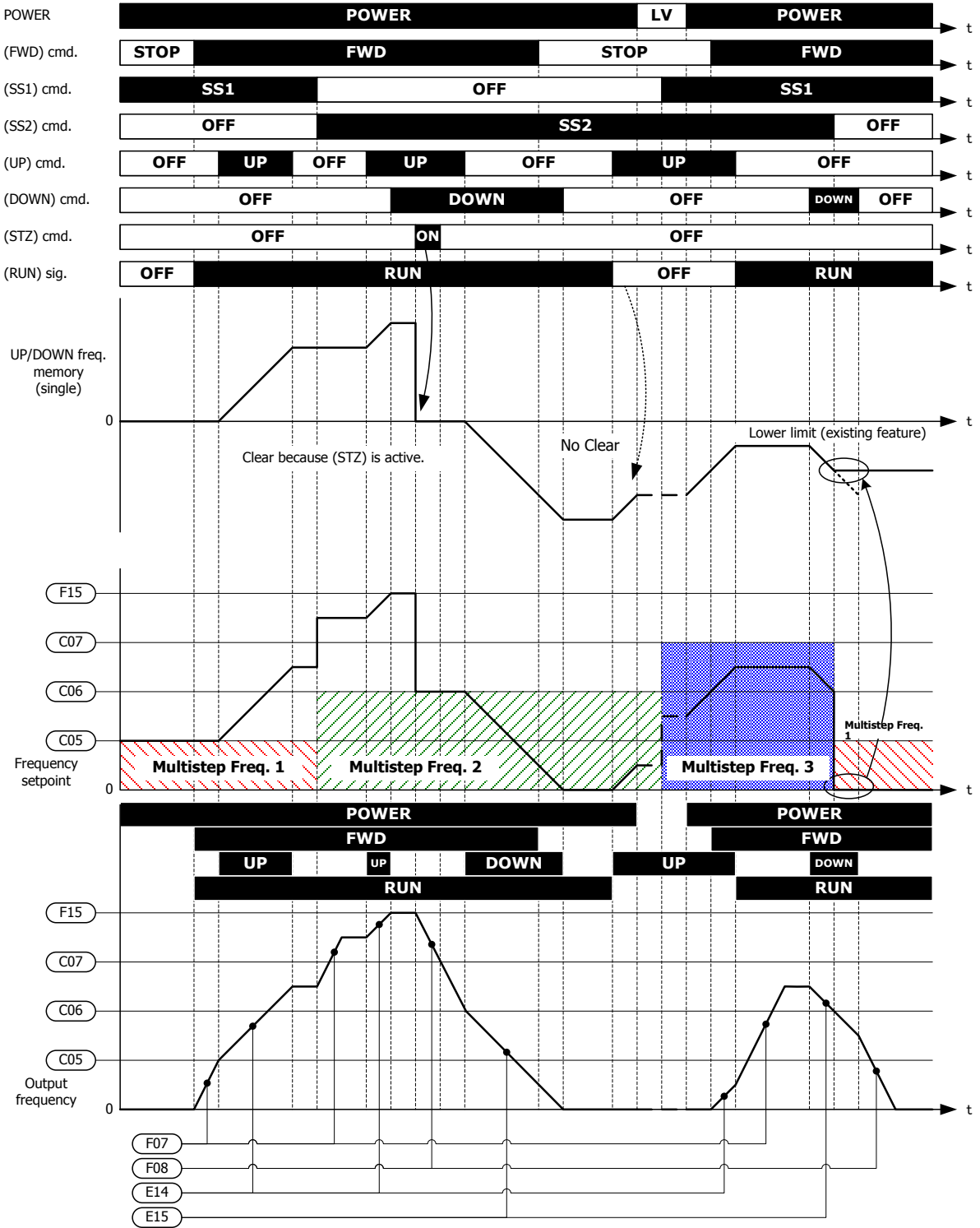

Multistep Frequency combined with UP/DOWN control overview (H61 = 26)

When H61 = 53

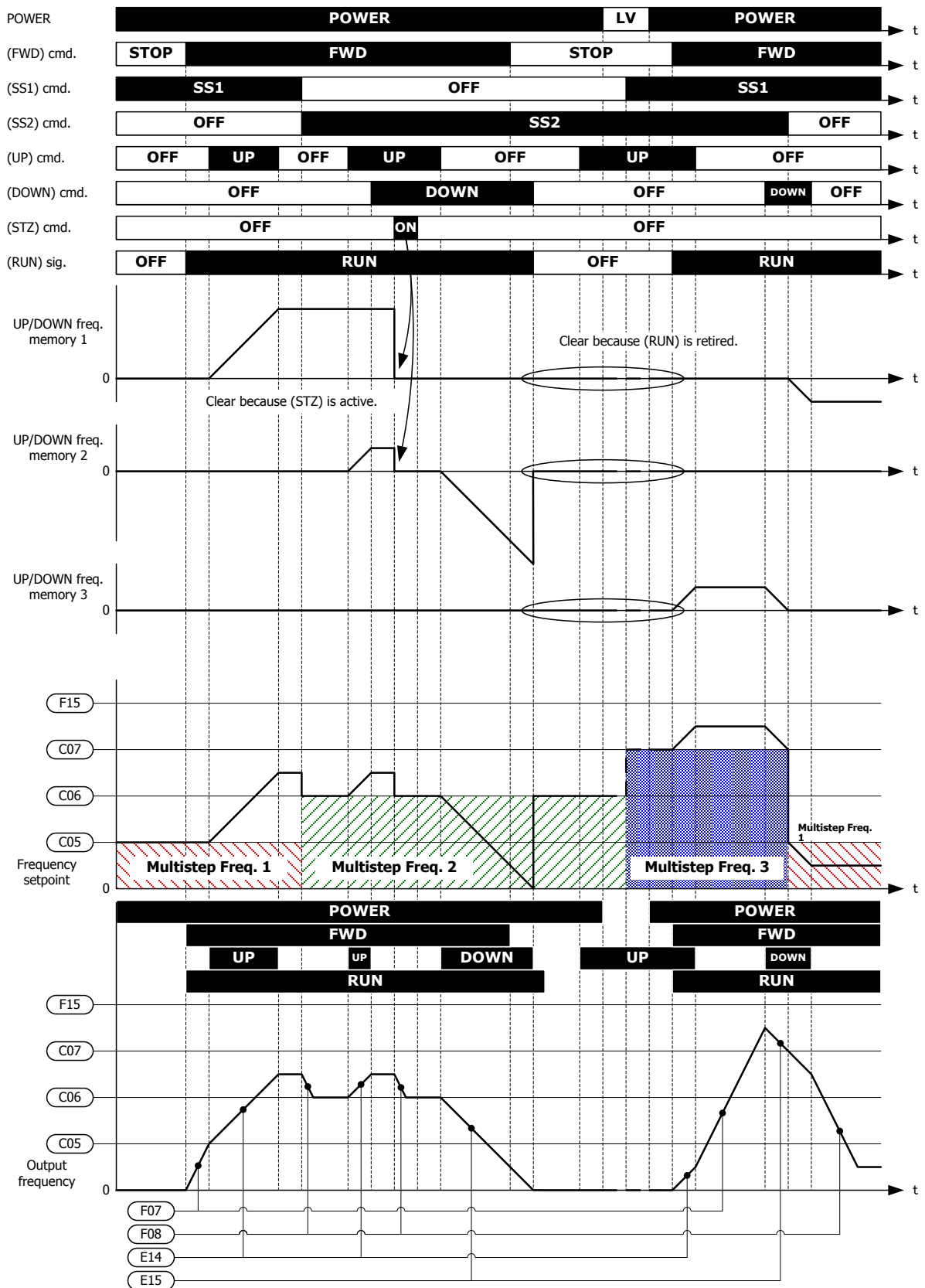

Multistep Frequency combined with UP/DOWN control overview (H61 = 53)

When H61 = 106

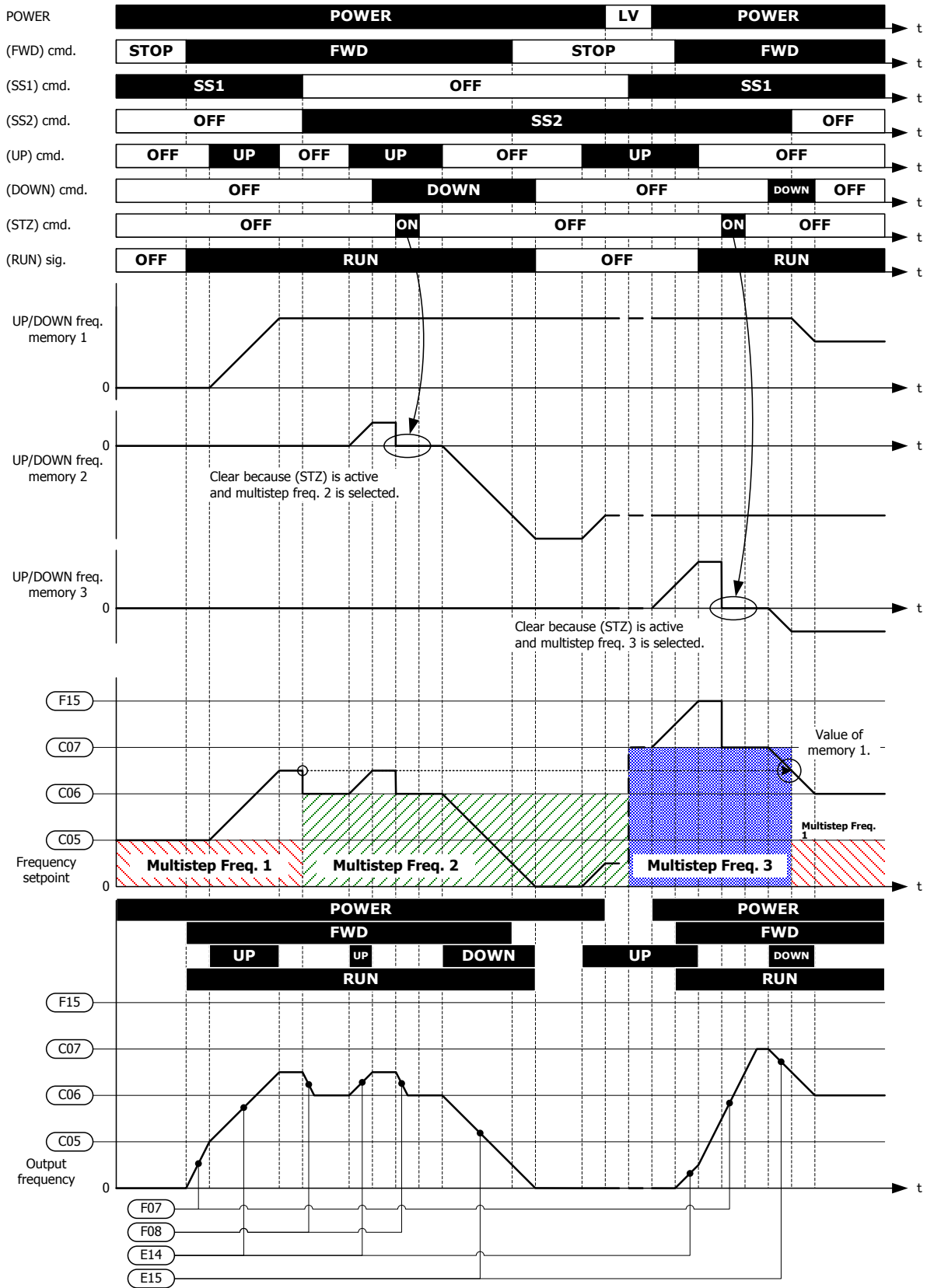

Multistep Frequency combined with UP/DOWN control overview (H61 = 106)

H63	Low Limiter (Mode selection)	(Refer to F15.)
------------	-------------------------------------	------------------------

For details, refer to the description of F15.

H64	Low Limiter (Lower limiting frequency)
------------	---

H64 specifies the lower limit of frequency to be applied when the current limiter, torque limiter, automatic deceleration (anti-regenerative control), or overload prevention control is activated. Normally, it is not necessary to change this data.

- Data setting range: Inherit, 0.0 to 60.0 (Hz)

H68	Slip Compensation 1 (Operating conditions)	(Refer to F42.)
------------	---	------------------------

For details, refer to the description of F42.

H69	Automatic Deceleration (Mode selection) H76 (Torque Limiter for Braking, Frequency increment limit)
------------	--

H69 toggles anti-regenerative control on and off.

In the inverter not equipped with a PWM converter or braking unit, if the regenerative energy returned exceeds the inverter's braking capability, an overvoltage trip occurs.

To avoid such an overvoltage trip, enable the automatic deceleration (anti-regenerative control) with this function code, and the inverter controls the output frequency to keep the braking torque around 0 N·m in both the acceleration/deceleration and constant speed running phases.

The FRENIC-HVAC series of inverters have two braking control modes; torque limit control and DC link bus voltage control. Understand the feature of each control and select the suitable one.

Control mode	Control process	Operation mode	Features
Torque limit control (H69=2 or 4)	Output frequency is controlled so that the braking torque is kept at the regeneration avoidance operation level (H114).	Enabled during acceleration, running at the constant speed, and deceleration.	Quick response. Causes less overvoltage trip with heavy impact load.
DC link bus voltage control (H69=3 or 5)	Control the output frequency to lower the DC link bus voltage if the voltage exceeds the limiting level.	Enabled during deceleration. Disabled during running at the constant speed.	Shorter deceleration time by making good use of the inverter's regenerative capability.

In addition, during deceleration triggered by turning the run command OFF, anti-regenerative control increases the output frequency so that the inverter may not stop the load depending on the load state (huge moment of inertia, for example). To avoid that, H69 provides a choice of cancellation of anti-regenerative control to apply when three times the specified deceleration time is elapsed, thus decelerating the motor forcibly.

Data for H69	Function	
	Control mode	Force-to-stop with actual deceleration time exceeding three times the specified one
0	Disable automatic deceleration	—
2	Torque limit control	Enable
3	DC link bus voltage control	Enable
4	Torque limit control	Disable
5	DC link bus voltage control	Disable

■ Torque Limiter for braking (Frequency increment limit) (H76)

- Data setting range: 0.0 to 500.0 (Hz)

Since increasing the output frequency too much in the torque limit control mode is dangerous, the inverter has a torque limiter (Frequency increment limit for braking) that can be specified by H76. The torque limiter limits the inverter's output frequency to less than "Reference frequency + H76 setting."

Note that the torque limiter activated restrains the anti-regenerative control, resulting in an overvoltage trip in some cases. Increasing the H76 data improves the anti-regenerative control capability.

■ Automatic deceleration (Operation level) (H114)

- Data setting range: Auto, 0.0 to 50.0 (%)

H114 specifies the anti-regenerative control operation level under torque limit control. The inverter controls the output frequency to keep the braking torque at the value specified with H114. When H114 = Auto (factory default), the anti-regenerative control starts with the inverter internal fixed value (approx. 2% to 5%). Do not change the factor default except when necessary.

- Note**
- Enabling the automatic deceleration (anti-regenerative control) may automatically increase the deceleration time.
 - If the set deceleration time is too short, the DC link bus voltage of the inverter rises quickly, and consequently, the automatic deceleration may not follow the voltage rise. If this is the case, set longer deceleration time.

H70

Overload Prevention Control

H70 specifies the decelerating rate of the output frequency to prevent a trip from occurring due to an overload. This control decreases the output frequency of the inverter before the inverter trips due to a heat sink overheat or inverter overload (with an alarm indication of OH1 or OLV, respectively). It is useful for equipment such as pumps where a decrease in the output frequency leads to a decrease in the load and it is necessary to keep the motor running even when the output frequency drops.

Data for H70	Function
Inherit	Decelerate the motor with the preset deceleration time
0.01 to 100.0	Decelerate the motor by deceleration rate from 0.01 to 100.0 (Hz/s)
OFF	Cancel overload prevention control

■ Overload prevention control -- **OLP**
(E20 to E24 and E27, data = 36)

This output signal comes ON when the overload prevention control is activated and the output frequency changed.

 Note In equipment where a decrease in the output frequency does not lead to a decrease in the load, the overload prevention control is of no use and should not be enabled.

H71 **Deceleration Characteristics**

Setting the H71 data to "1" enables forced brake control. If regenerative energy produced during the deceleration of the motor and returned to the inverter exceeds the inverter's braking capability, an overvoltage trip will occur. The forced brake control increases the motor energy loss during deceleration, increasing the deceleration torque.

Data for H71	Function
0	Disable
1	Enable

 Note This function is aimed at controlling the torque during deceleration; it has no effect if there is a braking load.

Enabling the automatic deceleration (anti-regenerative control, H69 = 2 or 4) in the torque limit control mode disables the deceleration characteristics specified by H71.

H72 **Main Power Down Detection (Mode selection)**

H72 monitors the inverter alternate-current input power source, and disables the inverter operation if it is not established.

Data for H72	Function
0	Disable
1	Enable

In cases where the power is supplied via a PWM converter or the inverter is connected via the DC link bus, there is no alternate-current input. In such cases, set H72 data to "0," otherwise the inverter cannot operate.

 Note If you use a single-phase power supply, contact your Fuji Electric representative.

H76 **Torque Limiter for Braking (Frequency increment limit)** (Refer to H69.)

For details, refer to the description of H69.

H77 Service Life of DC Link Bus Capacitor (Remaining time)

H77 displays the remaining time before the service life of DC link bus capacitor expires in units of ten hours.

At the time of a printed circuit board replacement, transfer the service life data of the DC link bus capacitor to the new board.

- Data setting range: 0 to 4380 (in units of ten hours, 0 to 43,800 hours)

H78 H94 Maintenance Interval (M1) Cumulative Motor Run Time 1

H78 specifies the maintenance interval in units of ten hours.

The maximum setting is 9999 × 10 hours.

- Data setting range: OFF (Disable)
1 to 9999 (99990 hours, in units of ten hours)

■ Maintenance timer -- **MNT** (E20 to E24 and E27, data = 84)

When the cumulative motor run time 1 (H94) reaches the setting specified by H78, the inverter outputs the maintenance timer signal **MNT** (if assigned to any digital terminal with any of E20 to E24 and E27) to remind the user of the need of the maintenance of the machinery.

■ Cumulative motor run time 1 (H94)

Operating the keypad can display the cumulative run time of the 1st motor. This feature is useful for management and maintenance of the machinery. Using H94 can modify the cumulative run time to the desired value to be used as an arbitrary initial data on which the replacement timing of machine parts or inverter is based. Specifying "blank" clears the cumulative run time of the motor.

<Biannual maintenance>

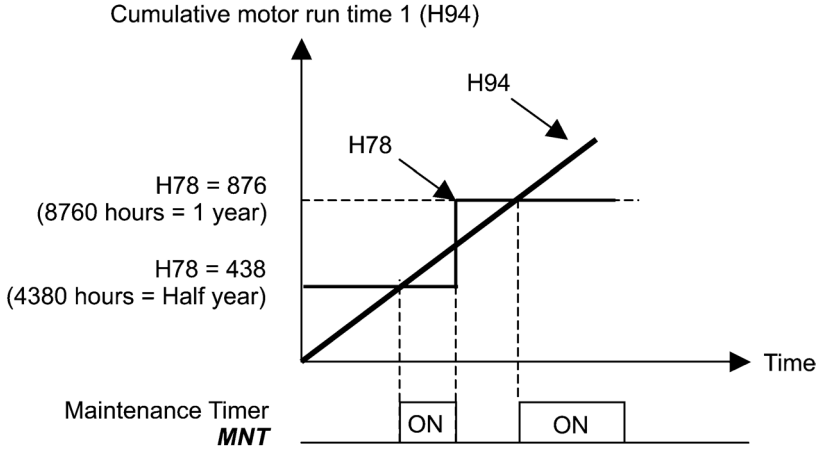

Note If the maintenance interval counter reaches the specified value, set a new value for the next maintenance in H78 and press the **SET** key to reset the output signal and restart counting. This function is exclusively applied to the 1st motor.

- Count the run time of commercial power-driven motor 1 -- **CRUN-M1** (E01 to E07, data = 72)

Even when a motor is driven by commercial power, not by the inverter, it is possible to count the cumulative motor run time 1 (H94) by detecting the ON/OFF state of the auxiliary contact of the magnetic contactor for switching to the commercial power line.

Note Check the cumulative motor run time with **PRG > 3(INV Info) > 4(Maintenance)** on the keypad.

H79

Preset Startup Count for Maintenance (M1) H44 (Startup Counter for Motor 1)

H79 specifies the number of inverter startup times to determine the next maintenance timing, e.g., for replacement of a belt.

Set the H79 and H44 data in hexadecimal. The maximum setting count is 65,535.

- Data setting range: OFF (Disable), 1 to 65,535

- Maintenance timer -- **MNT** (E20 to E24 and E27, data = 84)

When the startup counter for motor 1 (H44) reaches the number specified by H79 (Preset startup count for maintenance (M1)), the inverter outputs the maintenance timer signal **MNT** (if assigned to any digital terminal with any to E20 to E24 and E27) to remind the user of the need of the maintenance of the machinery.

< Maintenance every 1,000 times of startups >

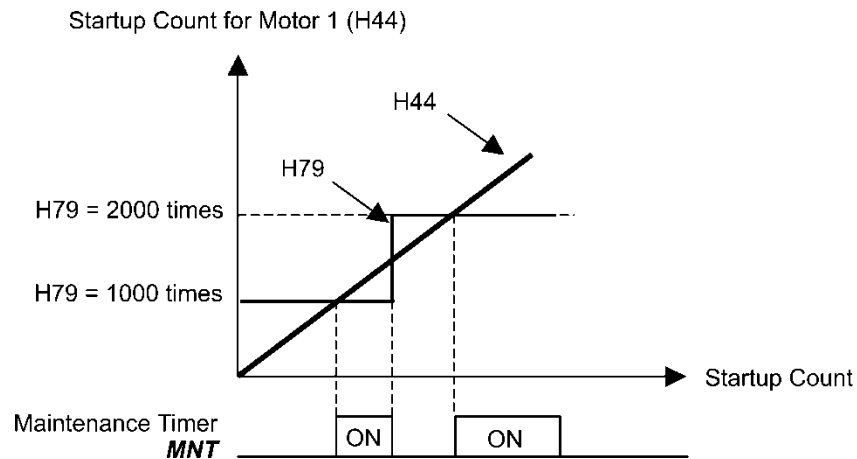

Note If the startup counter reaches the specified value, set a new value for the next maintenance in H79 and press the **SET** key to reset the output signal and restart counting. This function is exclusively applied to motor 1.

H80

Output Current Fluctuation Damping Gain for Motor 1

The inverter output current driving the motor may fluctuate due to the motor characteristics and/or backlash in the machinery (load). Modifying the H80 data adjusts the controls in order to suppress such fluctuation. However, as incorrect setting of this gain may cause larger current fluctuation, do not modify the default setting unless it is necessary.

- Data setting range: 0.00 to 1.00

H89 to H90	Reserved
-------------------	-----------------

These function codes and their data appear on the LCD monitor, but they are reserved for particular manufacturers. Do not access them.

H91	Current Input Wire Break Detection
------------	---

Using terminal [C1] (current input) enables wire break detection and alarm (CoF) issuance. H91 specifies whether to enable the wire break detection, and the duration of detection. (The inverter judges an input current of less than 2 mA on terminal [C1] as a wire break.)

- Data setting range: OFF (Disable alarm detection)
- 0.1 to 60.0 s (Detect wire break and issue CoF alarm within the time)

H92, H93	Continuity of Running (P and I)	(Refer to F14.)
-----------------	--	------------------------

Refer to the description of F14.

H94	Cumulative Motor Run Time 1	(Refer to H78.)
------------	------------------------------------	------------------------

Refer to the description of H78.

H95	DC Braking (Braking response mode)	(Refer to F20 through F22.)
------------	---	------------------------------------

Refer to the descriptions of F20 through F22.

H96**STOP Key Priority/Start Check Function**

H96 specifies a functional combination of "STOP key priority" and "Start check function" as listed below.

Data for H96	STOP key priority	Start check function
0	Disable	Disable
1	Enable	Disable
2	Disable	Enable
3	Enable	Enable

■ STOP key priority



Even when a run command is entered from a digital input terminal or via the RS-485 communications link (link operation), pressing the  key forces the inverter to decelerate to stop the motor. After that, an Er6 alarm occurs.

■ Start check function

For safety, this function checks whether any run command has been turned ON or not in each of the following situations. If any has been turned ON, the inverter does not start up with alarm code Er6 displayed.

- When the power to the inverter is turned ON.
- When the  key is pressed to release an alarm status or when the digital input terminal command **RST** ("Reset alarm") is turned ON.
- When the run command source is switched by a digital input terminal command such as **LE** ("Enable communications link via RS-485 or fieldbus") or **LOC** ("Select local (keypad) operation").

H97**Clear Alarm Data****H45 (Mock Alarm)**

H97 clears alarm data (alarm history and relevant information) stored in the inverter. To clear alarm data, simultaneous keying of " key +  key" is required.

Data for H97	Function
0	Disable
1	Enable (Setting "1" clears alarm data and then returns to "0.")

H98

Protection/Maintenance Function (Mode selection)

H98 specifies whether to enable or disable automatic lowering of carrier frequency, input phase loss protection, output phase loss protection, judgment threshold on the life of DC link bus capacitor, judgment on the life of DC link bus capacitor, DC fan lock detection, and NEMA UL TYPE 1/ TYPE12 switching, in combination (Bit 0 to Bit 7).

Automatic lowering of carrier frequency (Bit 0)

This function should be used for important machinery that requires keeping the inverter running.

Even if a heat sink overheat or overload occurs due to excessive load, abnormal ambient temperature, or cooling system failure, enabling this function lowers the carrier frequency to avoid tripping (OH1, OH3 or OLU). Note that enabling this function results in increased motor noise.

Input phase loss protection (Lin) (Bit 1)

Upon detection of an excessive stress inflicted on the apparatus connected to the main circuit due to phase loss or line-to-line voltage unbalance in the three-phase power supplied to the inverter, this protection feature stops the inverter and displays an alarm Lin.

 **Note** In configurations where only a light load is driven, phase loss or line-to-line voltage unbalance may not be detected because of the relatively small stress on the apparatus connected to the main circuit.



Output phase loss protection (OPL) (Bit 2)

Upon detection of output phase loss while the inverter is running, this feature stops the inverter and displays an alarm OPL.

 **Note** Where a magnetic contactor is installed in the inverter output circuit, if the magnetic contactor goes OFF during operation, all the phases will be lost. In such a case, this protection feature does not work.

Judgment threshold on the life of DC link bus capacitor (Bit 3)

Bit 3 is used to select the threshold for judging the life of the DC link bus capacitor--the factory default level or a user-defined one.

 **Note** Before specifying a user-defined threshold, measure and confirm the reference level in advance.  Refer to H42.

Judgment on the life of DC link bus capacitor (Bit 4)

Whether the DC link bus capacitor has reached its life is judged by measuring the discharging time after power OFF. The discharging time is determined by the capacitance of the DC link bus capacitor and the load inside the inverter. Therefore, if the load inside the inverter fluctuates significantly, the discharging time cannot be accurately measured, and as a result, it may be mistakenly determined that the DC link bus capacitor has reached the end of its life. To avoid such an error, you can disable the judgment based on the discharging time. (Even if it is disabled, the judgment based on the "ON-time counting" while the voltage is applied to the DC link bus capacitor is continued.)

 For details about the life prediction function, refer to H42.

Since load may fluctuate significantly in the following cases, disable the judgment on the life during operation. During periodical maintenance, either conduct the measurement with the judgment enabled under appropriate conditions or conduct the measurement under the operating conditions matching the actual ones.

- Auxiliary input for control power is used.
- An option card is used.
- Another inverter or equipment such as a PWM converter is connected to terminals of the DC link bus.

DC fan lock detection (Bit 5) (for UL open type-rated inverters of 150 HP or above, NEMA/UL TYPE 1-rated ones of 60 HP or above, and NEMA/UL TYPE 12-rated ones of 15 HP or above)

The inverter contains an internal air circulation DC fan. When the inverter detects that the DC fan is locked by a failure or other cause, you can select either continuing the inverter operation or having the inverter enter into the alarm state.

Entering alarm state: The inverter issues the alarm OH1 and allows the motor to coast to a stop.

Continuing operation: The inverter does not enter the alarm state and continues to run the motor.

Note that, however, the inverter turns ON the **OH** and **LIFE** signals on the transistor output terminals whenever the DC fan lock is detected regardless of your selection.

 **Note** If the ON/OFF control of the cooling fan is enabled (H06 = 1), the cooling fan may stop depending on the operating condition of the inverter. In this case, the DC fan lock detection feature is considered normal (e.g., the cooling fan is normally stopped by the stop fan command.) so that the inverter may turn OFF the **LIFE** or **OH** signal output, or enable to cancel the alarm OH1, even if the internal air circulation DC fan is locked due to a failure etc. (When you start the inverter in this state, it automatically issues the run fan command. Then the inverter detects the DC fan lock state, and turns ON the **LIFE** or **OH** output or enters the alarm OH1 state.)

Note that, operating the inverter with the DC fan being locked for a long time may shorten the service life of electrolytic capacitors on the PCBs due to local high temperature inside the inverter. Be sure to check with the **LIFE** signal etc., and replace the broken fan as soon as possible.

NEMA/UL TYPE1/ UL TYPE 12 switch (Bit 7)

Switch this when changing the protection structure from NEMA/UL TYPE1 to NEMA/UL TYPE12. With respect to protection coordination, a protection level which suits for NEMA/UL TYPE12 is resulted.

To set data of function code H98, assign the setting of each function to each bit and then convert the 8-bit binary to the decimal number.

Refer to the assignment of each function to each bit and a conversion example below.

Bit	Function	Data setting range	Factory default	
			NEMA/UL TYPE1	NEMA/UL TYPE12
0	Lower the carrier frequency automatically	0: Disable 1: Enable	1: Enable	1: Enable
1	Detect input phase loss	0: Continue to run 1: Enter alarm processing	1: Enter alarm processing	1: Enter alarm processing
2	Detect output phase loss	0: Continue to run 1: Enter alarm processing	0: Continue to run	0: Continue to run
3	Select life judgment threshold of DC link bus capacitor	0: Factory default 1: User-defined setting	0: Factory default	0: Factory default
4	Judge the life of DC link bus capacitor	0: Disable 1: Enable	1: Enable	1: Enable
5	DC fan lock detection (Available for UL open type-rated inverters of 150 HP or above, NEMA/UL TYPE 1-rated ones of 60 HP or above, and NEMA/UL TYPE 12-rated ones of 15 HP or above)	0: Enable 1: Disable	0: Enable	0: Enable
6	--	--	--	--
7	Switch NEMA/UL TYPE 1/TYPE 12 enclosure	0: NEMA/UL TYPE 1 1: NEMA/UL TYPE 12	0: NEMA/UL TYPE 1	1: NEMA/UL TYPE 12

6.3.6 H1 codes (High performance functions)

H104	Number-of-resets Clear Time H04, H05 (Auto-reset (Times and Reset interval))
-------------	--

H104 specifies the time for clearing the number of resets counted.

The inverter clears the number of retries counted if

After restart following a reset, if the inverter output frequency comes to be constant and an alarm that causes a reset does not occur during the number-of-resets clear time (H104), then the inverter clears the number of resets counted.

- Data setting range: 0.5 to 5.0 (min)

<Operation timing scheme>

- In the figure below, normal operation restarts in the 3rd retry. (An alarm that causes a reset does not occur during the time specified by H104.)

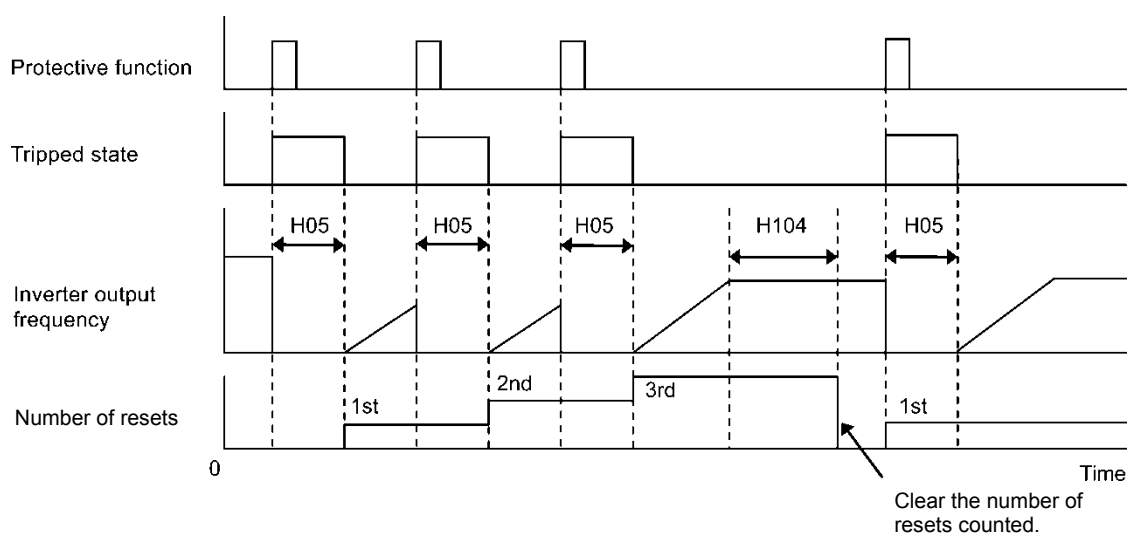

H105 H106	Retry Target Selection H04, H05 (Auto-reset (Times and Reset interval)) H104 (Number-of-retry Clear Time)
----------------------	--

To set and display the retry alarm factors in binary format, each retry alarm factor has been assigned to bits 0 to 7 as listed in Table 6.1 and Table 6.2.

■ Retry target selection 1 (H105)

Table 6.1 H105 Retry Target Selection 1, Bit Assignment of Selectable Factors

Indication on the LCD	0	0	0	0	0	0	0	0
Bit	7	6	5	4	3	2	1	0
Protective function	-	-	Motor overheat	Motor overload	-	Overheat protection	Overvoltage protection	Overcurrent protection
Alarm code	-	-	OH4	OL1	-	OH1 OH3 OLU	OU1 OU2 OU3	OC1 OC2 OC3

- Data setting range: 00000000 to 11111111 (binary)

■ Retry target selection 2 (H106)

Table 6.2 H106 Retry Target Selection 2, Bit Assignment of Selectable Factors

Indication on the LCD	0	0	0	0	0	0	0	0
Bit	7	6	5	4	3	2	1	0
Protective function	-	-	-	-	-		Undervoltage	External alarm
Alarm code	-	-	-	-	-		LV	OH2

- Data setting range: 00000000 to 11111111 (binary)

H110

Input Phase Loss Protection Avoidance Operation (Mode selection)

If phase loss or line-to-line voltage unbalance is detected in the three-phase power supplied to the inverter, the input phase loss protection (Lin, on Bit 1 of H98) is activated.

H110 specifies whether to avoid activating the protection by automatically decreasing the output frequency or stop the inverter due to an alarm Lin.

- Data setting range: 0 (Disable), 1 (Enable)

H112

**Voltage Shortage Avoidance Operation (Mode selection)
H98 (Protection/Maintenance Function (Mode selection))**

If the inverter output voltage level drops below the commanded value (under V/f control) due to insufficient three-phase power, the output current may increase depending upon the load state.

H112 specifies whether to avoid such an event by automatically decreasing the output frequency until the inverter can output the commanded voltage.

Note: Under V/f control, decreasing the output voltage decreases the output voltage (command value) proportionally.

- Data setting range: 0 (Disable), 1 (Enable)

H114

Automatic Deceleration (Operation level) (See H69.)

Settings for automatic deceleration (operation level) are detailed in the section for function code H69.

H116 H117 H118 H119 H120 H121	Fire Mode (Mode selection) (Confirmation time) (Reference frequency) (Rotation direction) (Start method) (Reset interval)
--	--

Set when enabling forced operation (Fire Mode). In an emergency, operation at a specified speed can be performed. Even when an alarm of the inverter is generated, operation is continued. In such a case where instant overcurrent protection occurs, the retry function is to be used to restart the operation.

Assigning the **FMS** to a digital input terminal and turning the **FMS** ON enables forced operation (Fire Mode). (Function code E01 to E07; data = 134)

Note When the inverter is running with the **FMS** being ON, the protective function is disabled. Therefore, the inverter keeps running even if an alarm occurs so that the inverter could be broken or a fire could occur.

■ Fire Mode (Mode selection) (H116)

- Data setting range: 0 to 2

Turning **FMS** ON enables forced operation (Fire Mode). Three different operation selections are possible.

Data 0: Enabled with **FMS** ON; disabled with **FMS** OFF

Data 1: Toggle method Enabled with **FMS** ON/OFF; disabled with the next **FMS** ON/OFF

Data 2: Latch method Enabled with **FMS** ON (This status is kept.)

■ Fire Mode (Confirmation time) (H117)

- Data setting range: 0.5 to 10.0 (s)

Set ON/OFF setting time for **FMS** signals. If **FMS** is turned ON/OFF in time shorter than the specified value, forced operation (Fire Mode) is not enabled. **FMS** signals are to be kept ON longer than the H117 confirmation time.

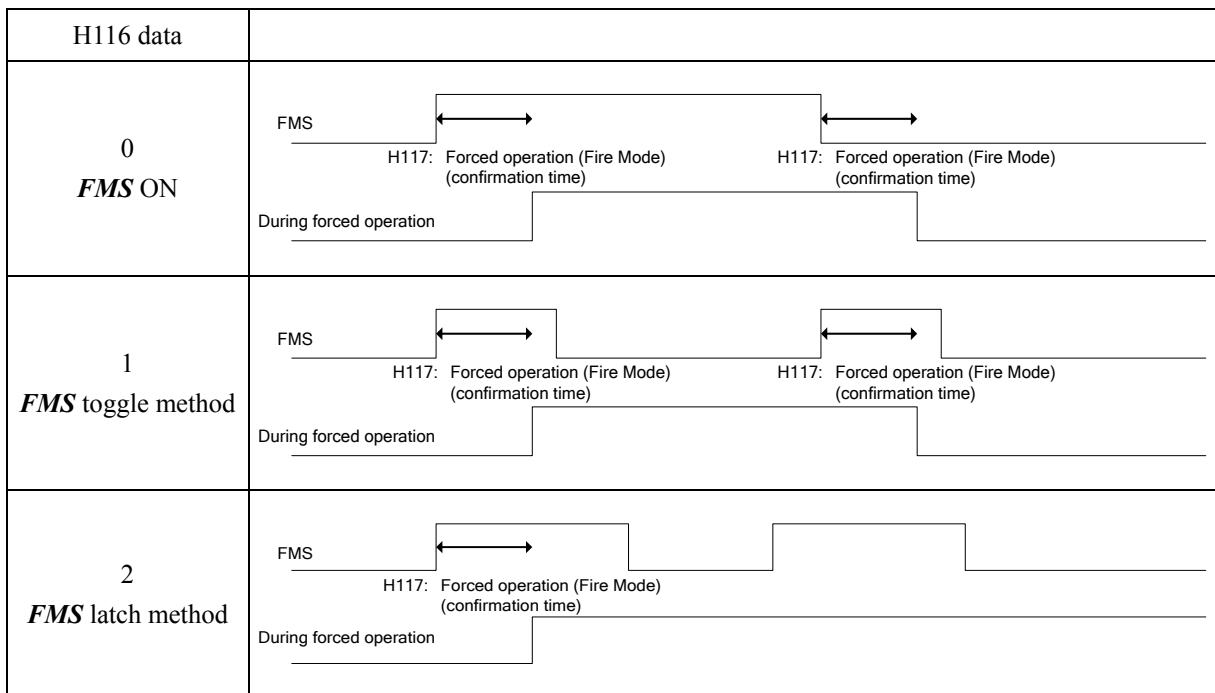

■ Fire Mode (Reference frequency) (H118)

- Data setting range: Inherit, 0.1 to 120.0 (Hz)

Specify speed (reference frequency) at which operation is to be performed when forced operation (Fire Mode) is enabled.

H118 data	Function
Inherit	The frequency selected through frequency setting 1 (F01) and 2 (C30) is followed.
0.1 to 120.0	Arbitrary frequencies can be set in 0.1 Hz steps.

■ Fire Mode (Rotation direction) (H119)

- Data setting range: 0, 2, 3

Set an operation instruction (rotation direction) to be followed when forced operation (Fire Mode) is enabled.

H119 data	Function
0	Follows the operation instruction selected through drive operation (F02). * When the operation instruction is OFF, operation is not performed at the frequency specified with H118 (reference frequency). Note, however, that the mode at that time is forced operation execution status.
2	Operation through forward rotation (FWD) * Forward rotation is forcibly performed irrespective of presence and absence of an operation instruction.
3	Operation through reverse rotation (REV) * Reverse rotation is forcibly performed irrespective of presence and absence of an operation instruction.

■ Fire Mode (Start method) (H120)

- Data setting range: 0, 1

Set the start method to be followed when Fire Mode is enabled.

H120 data	Function
0	Follows the start methods specified with instant power failure restart (F14) and H09 (starting mode).
1	STM mode (auto search for idling motor speed to run the idling motor without stopping it)

■ Fire Mode (Reset interval) (H121)

- Data setting range: 0.5 to 20.0 (s)

Set time delay to auto cancel of trip status for a case where the inverter enters trip status and stops during forced operation (Fine Mode).

H181
H182
H183
H184

Light Alarm Selection 1
Light Alarm Selection 2
Light Alarm Selection 3
Light Alarm Selection 4

If a detected abnormal state represents a minor failure, an alarm (display and general-purpose output terminal) is output and operation can be continued without inverter trip. When a minor failure occurs, an alarm icon which designates its occurrence is shown on an LCD monitor and the WARN. LED blinks. What is to be subjected to this function can be selected with function codes H181, H182, H183, and H184. If minor failure "LALM" (data = 98) is assigned to a general-purpose output terminal (function code E20 to E24, E27), minor failure "LALM" signals are output to the terminal when a minor failure occurs.

The table below lists alarms selectable as minor failure factors.

Code	Name	Description
OH2	External alarm	An error that has occurred in peripheral equipment turned the external alarm signal THR ON.
OH3	Inverter internal overheat	The temperature inside the inverter abnormally has increased.
OL1	Overload of motor 1	Motor temperature calculated with the inverter output current reached the trip level.
Er4	Option communications error	Communications error between the inverter and an option.
Er5	Option error	An option judged that an error occurred.
Er8 ErP	RS-485 communications error (COM port 1) RS-485 communications error (COM port 2)	RS-485 communications error between the COM ports 1 and 2.
CoF	Current input wire break	Wire connected to terminal [C1] (current input) is broken.
PV1 PV2 PVA PVb PVC	PID feedback error detection	Error in PID feedback signals (PID control 1, PID control 2, External PID control 1 to 3)
FAL	DC fan locked	Failure of the air circulation DC fan inside the inverter. (For UL open type rated inverters of 150 HP or above, NEMA/UL TYPE 1 rated ones of 60 HP or above, and NEMA/UL TYPE 12 rated ones of 150 HP or above)
OL	Motor overload early warning	Early warning before a motor overload
OH	Heat sink overheat early warning	Early warning before a heat sink overheat trip
LiF	Lifetime alarm	It is judged that the service life of any one of the capacitors (DC link bus capacitors and electrolytic capacitors on the printed circuit boards) and cooling fan has expired. Or, failure of the air circulation DC fan inside the inverter. (NEMA/UL TYPE 12 only)
rEF	Reference command loss detected	Analog frequency command was lost.
PA1 PA2 PAA PAb PAC	PID alarm	Warning related to PID control (absolute-value alarm or deviation alarm) (PID control 1, PID control 2, External PID control 1 to 3)
UTL	Low torque output	Output torque drops below the low torque detection level for the specified period.

Code	Name	Description
PTC	PTC thermistor activated	The PTC thermistor on the motor detected a temperature.
rTE	Inverter life (Cumulative motor run time)	The motor cumulative run time reached the specified level.
CnT	Inverter life (Number of startups)	Number of startups reached the specified level.
Lob dtL	Low battery alarm Real-time clock (RTC) info lost	- Low battery charge of RTC backup battery (option) - Date and time info was lost.

■ **Selecting light alarm factors**

To set and display the light alarm factors in binary format, each light alarm factor has been assigned to bits 0 to 7 as listed in Tables 6.3 through 6.6. Set the bit that corresponds to the desired light alarm factor to "1."

- Data setting range: 00000000 to 11111111 (binary)

■ **Light Alarm Selection 1 (H181)**

Table 6.3 Light Alarm Selection 1 (H181), Bit Assignment of Selectable Factors

Indication on the LCD	0	0	0	0	0	0	0	0
Bit	7	6	5	4	3	2	1	0
Protective function	-	-	Overload of motor 1	-	-	Inverter internal overheat	External alarm	-
Alarm code	-	-	OL1	-	-	OH3	OH2	-

■ **Light Alarm Selection 2 (H182)**

Table 6.4 Light Alarm Selection 2 (H182), Bit Assignment of Selectable Factors

Indication on the LCD	0	0	0	0	0	0	0	0
Bit	7	6	5	4	3	2	1	0
Protective function	-	-	RS-485 communications error (COM port 2)	RS-485 communications error (COM port 1)	Option error	Option communications error	-	-
Alarm code	-	-	ErP	Er8	Er5	Er4	-	-

■ Light Alarm Selection 3 (H183)

Table 6.5 Light Alarm Selection 3 (H183), Bit Assignment of Selectable Factors

Indication on the LCD	0	0	0	0	0	0	0	0
Bit	7	6	5	4	3	2	1	0
Protective function	Lifetime alarm	Heat sink overheat early warning	Motor overload early warning	DC fan locked	Current input detection, wire break detection PID feedback error	-	-	-
Alarm code	LiF	OH	OL	FAL	CoF, PV1 PV2, PVA PVB, PVC	-	-	-

■ Light Alarm Selection 4 (H184)

Table 6.6 Light Alarm Selection 4 (H184), Bit Assignment of Selectable Factors

Indication on the LCD	0	0	0	0	0	0	0	0
Bit	7	6	5	4	3	2	1	0
Protective function	Low battery alarm, Real-time clock lost	-	Inverter life (Number of startups)	Inverter life (Cumulative motor run time)	PTC thermistor activated	Low torque output	PID alarm	Reference command loss detected
Alarm code	Lob dtL	-	CnT	rTE	PTC	UTL	PA1, PA2 PAA, PAb PAC	rEF



When H26 (thermistor (mode selection))= 1 (PTC (The inverter immediately trips with OH4 displayed and stops)), the inverter stops without minor failure operations, regardless of the assignment of bit 3 (PTC thermistor activated) by H184 (Light Alarm Selection 4).

■ Light alarm--**L-ALM** (E20 to E24 and E27, data = 98)

This output signal comes ON when a light alarm occurs.

H197	User Password 1 (Mode selection)
-------------	---

H197 specifies the password function to apply when password 1 is set.

Data for H197	Function
0	Disclose all function codes but prohibit any change
1	Disclose function codes selected for quick setup and allow change

6.3.7 J codes (Application functions 1)

J21 Dew Condensation Prevention (Duty)

When the inverter is stopped, dew condensation on the motor can be prevented, by feeding DC power to the motor at regular intervals to keep the temperature of the motor above a certain level.

■ Enabling Dew Condensation Prevention

To utilize this feature, you need to assign the terminal command **DWP** ("Protect motor from dew condensation") to one of the general-purpose digital input terminals.

(E01 to E07, data = 39)

■ Dew Condensation Prevention (Duty) (J21)

The magnitude of the DC power applied to the motor is the same as the setting of F21 (DC braking 1, Braking level) and its duration of each interval is the same as the setting of F22 (DC braking 1, Braking time). Interval T is determined so that the ratio of the duration of the DC power to T is the value (Duty) set for J21.

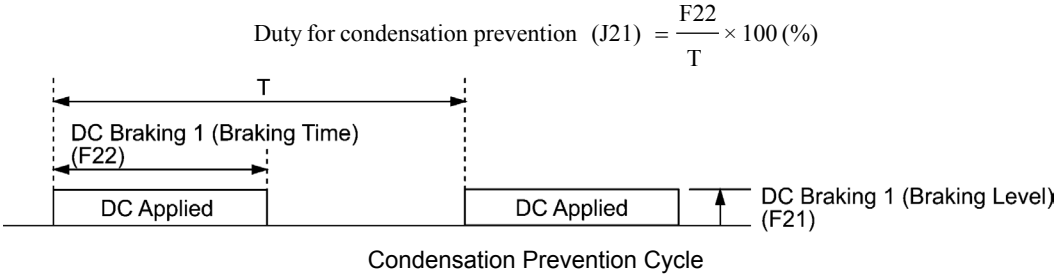

J22 Commercial Power Switching Sequence (Refer to E01 through E07.)

Refer to the description of **ISW50** and **ISW60** (Enable integrated sequence to switch to commercial power) in E01 through E07.

6.3.8 J1 codes (PID control 1)

J101	PID Control 1 (Mode selection)	J202 (PID Control 2 (Mode selection))
------	--------------------------------	---------------------------------------

Under PID control, the inverter detects the state of a control target object with a sensor or the similar device and compares it with the commanded value (e.g., temperature control command). If there is any deviation between them, PID control operates to minimize it. That is, it is a closed loop feedback system that matches controlled variable (feedback amount). PID control expands the application area of the inverter to process control (e.g., flow control, pressure control, and temperature control).

If PID control is enabled (J101, J201 = 1, 2), the frequency control of the inverter is switched from the drive frequency command generator block to the PID command generator block.

■ Mode Selection (J101, J201)

- Data setting range: 0 to 2

Data for J101, J201	Function
0	Disable
1	Enable (Process control, normal operation. When SV > PV, MV increases.)
2	Enable (Process control, inverse operation. When SV < PV, MV increases)

PID process control block diagram

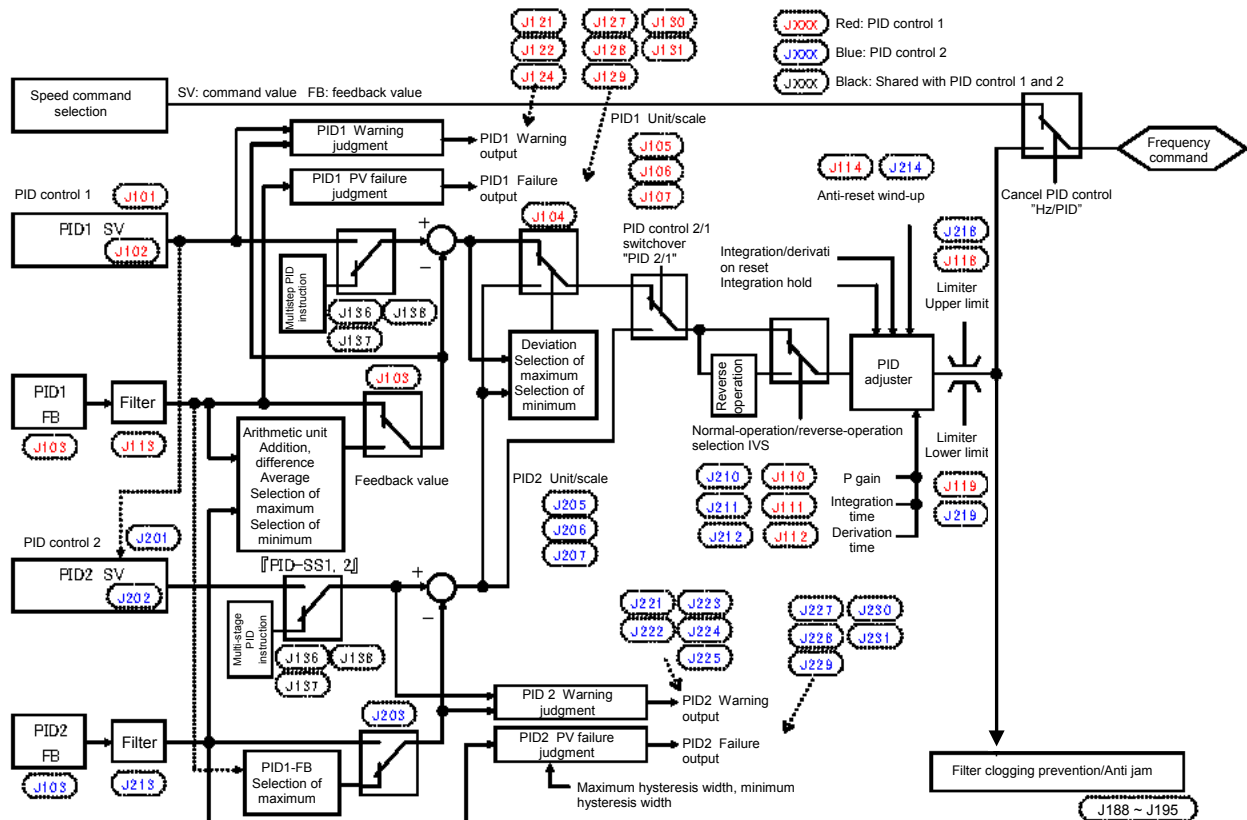

- Using J01 enables switching between normal and inverse operations against the PID process control output, so you can specify an increase/decrease of the motor rotating speed to the difference (error component) between the commanded (input) and feedback amounts, making it possible to apply the inverter to air conditioners. The terminal command *IVS* can also switch operation between normal and inverse.

For details about the switching of normal/inverse operation, refer to the description of Switch normal/inverse operation *IVS* (E01 to E07, data = 21).

- Switchover of PID control

Different from PID control 1, assigned values and feedback values can be input for PID control 2. PID control 1 and PID control 2 can be switched. Signals (PID channel switchover PID2/1) assigned to the digital input terminal from external equipment are to be used to switch.

Input signal PID2/1	PID control to be selected
OFF	PID control 1
ON	PID control 2

Switching PID control 1 and PID control 2 causes the codes shown in the table below to be switched.

Control Code Name	PID Control 1	PID Control 2
Operation selection	J101	J201
Command selection	J102	J202
Feedback selection	J103	J203
Deviation selection	J104	Disabled under PID control 2.
Display units	J105	J205
Max. scale, min. scale	J106, J107	J206, J207
P (Gain)	J110	J210
I (Integral time)	J111	J211
D (Differential time)	J112	J212
Feedback filter	J113	J213
Anti-reset windup	J114	J214
PID output limiter max., min.	J118, J119	J218, J219
Alarm output	J121, J122, J124	J221 through J225
Feedback error detection	J127 through J131	J227 through J231
PID multistep command	J136 through J138	PID control 1 settings take effect even under PID control 2.
Slow flowrate stop	J149 through J154 J156 through J160	J249 through J251 J256 through J260
Flowrate sensor selection	J163 through J166	PID control 1 settings take effect even under PID control 2.
Filter clogging prevention/anti-jam	J188 through J195	Filter clogging prevention is disabled under PID control 2. For anti-jam, PID control 1 settings take effect even under PID control 2.
Wet-bulb temperature presumption control	J198	Disabled under PID control 2

Select a method for setting a command value for PID control 1 and 2.

- Data setting range: 0 to 101

Data for J102	Data for J102	Function
0	0	PID commands with the keypad PID commands with the \triangleleft / \triangleright keys on the keypad
1	1	PID command 1 (Analog input: Terminals [12], [C1] and [V2]) Voltage input to the terminal [12] (0 to ± 10 VDC, 100% PID command/ ± 10 VDC) Current input to the terminal [C1] (4 to 20 mA DC, 100% PID command/20 mA DC) (0 to 20 mA DC, 100% PID command/20 mA DC) Voltage input to the terminal [V2] (0 to ± 10 VDC, 100% PID command/ ± 10 VDC)
-	2	PID command 2 (Analog input: Terminals [12], [C1] and [V2]) Voltage input to the terminal [12] (0 to ± 10 VDC, 100% PID command/ ± 10 VDC) Current input to the terminal [C1] (4 to 20 mA DC, 100% PID command/20 mA DC) (0 to 20 mA DC, 100% PID command/20 mA DC) Voltage input to the terminal [V2] (0 to ± 10 VDC, 100% PID command/ ± 10 VDC)
3	3	PID commands with <i>UP/DOWN</i> commands With <i>UP</i> and <i>DOWN</i> commands, a command value for PID control can be set by increasing/decreasing between the minimum and maximum scales.
4	4	Command via communications link Communications function code (S13): Communications data 20000 (decimal)/100% of the PID command.
-	101	Uses PID control 1 command (J102)

[1] PID command with the \triangleleft / \triangleright keys on the keypad (J102, J202 = 0, factory default)

Using the \triangleleft / \triangleright key on the keypad, you can set the control value at 0 to 100% of the PID control command, display units, scale and physical volume, in an easy-to-understand, converted command format.

For details of operation, refer to Chapter 5, Section 5.5.3 "Setting up frequency and PID commands".

-  For scale setting for terminal [12], refer to function codes C59 and C60.
- For scale setting for terminal [C1], refer to function codes C65 and C66.
- For scale setting for terminal [V2], refer to function codes C71 and C72.

[2] PID command by analog inputs 1 (J102, J202 = 1, 2)

When any analog input (voltage input to terminals [12] and [V2], or current input to terminal [C1]) for PID command 1 (J02 = 1) is used, it is possible to arbitrary specify the PID command by multiplying the gain and adding the bias. The polarity can be selected and the filter time constant and offset can be adjusted. In addition to J102 and J202 settings, it is necessary to select PID process commands 1 and 2 for analog input (specified by any of function codes E61 to E63). For details, refer to the descriptions of E61 to E63.

Adjustable elements of PID command

Input terminal	Input range	Bias		Gain		Polarity	Filter time constant	Offset	Range selection
		Bias	Base point	Gain	Base point				
[12]	0 to +10 V, -10 to +10V	C55	C56	C32	C34	C35	C33	C31	-
[C1]	4 to 20 mA	C61	C62	C37	C39	-	C38	C36	C40
[V2]	0 to +10 V, -10 to +10 V	C67	C68	C42	C44	C45	C43	C41	-

■ Offset (C31, C36, C41)

C31, C36 or C41 configures an offset for an analog voltage/current input. The offset also applies to signals sent from the external equipment.

■ Filter time constant (C33, C38, C43)

C33, C38, and C43 provide the filter time constants for the voltage and current of the analog input. Choose appropriate values for the time constants considering the response speed of the machinery system, as large time constants slow down the response. If the input voltage fluctuates because of noise, specify large time constants.

■ Polarity (C35, C45)

C35 and C45 specify the input range for analog input voltage.

Data for C35 and C45	Terminal input specifications
0	-10 to +10 V
1	0 to +10 V (negative value of voltage is regarded as 0 V)

■ Range selection: Terminal [C1]

Set an input range for terminal [C1] (analog input current).

Data for C40	Terminal input specifications
0	4 to 20 mA (factory default)
1	0 to 20 mA

■ Gain and bias

Terminal	Content
[12]	
[C1]	
[V2]	

(Example) Mapping the range of 1 through 5 V at terminal [12] to 0 through 100%

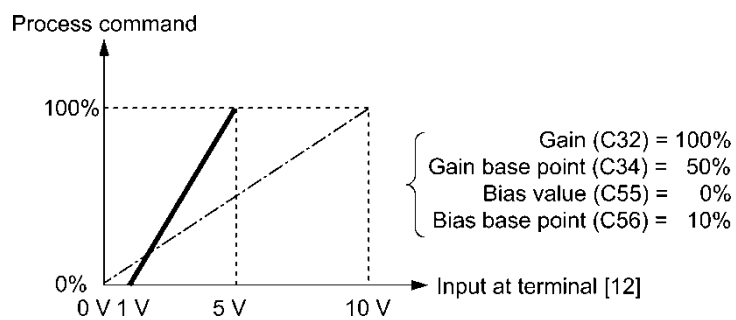

[3] PID command with **UP/DOWN** control (J102, J202 = 3)

When the **UP/DOWN** control is selected as a PID command, turning the terminal command **UP** or **DOWN** ON causes the PID command to change within the range from minimum scale to maximum scale.

This can be set using a physical unit by means of display unit (J105) and scale (J106, J107).

To select the **UP/DOWN** control as a PID command, the **UP** and **DOWN** should be assigned to the digital input terminals [X1] to [X7]. (📖 E01 to E07, data = 17, 18)

UP	DOWN	Function
Data = 17	Data = 18	
OFF	OFF	Retain PID command value.
ON	OFF	Increase PID command value at a rate between 0.1%/0.1 s and 1%/0.1 s.
OFF	ON	Decrease PID command value at a rate between 0.1%/0.1 s and 1%/0.1 s.
ON	ON	Retain PID command value.

 **Note** Setting commands via the **UP/DOWN** control is the same as for external PID controls 1, 2 and 3 (J501, J601 and J651).

[4] PID command via communications link (J102, J202 = 4)

Use function code S13 that specifies the communications-linked PID command. The transmission data of 20000 (decimal) is equal to 100% (maximum frequency) of the PID command. For details of the communications format, refer to the RS-485 Communication User's Manual.

Selecting Feedback Terminals

For feedback control, determine the connection terminal according to the type of the sensor output.

- If the sensor is a current output type, use the current input terminal [C1] of the inverter.
- If the sensor is a voltage output type, use the voltage input terminal [12] of the inverter, or switch over the terminal [V2] to the voltage input terminal and use it.

📖 For details, refer to the descriptions of E61 through E63.

Application example: Process control (for air conditioners, fans and pumps)

The operating range for PID process control is internally controlled as 0% through 100%. For the given feedback input, determine the operating range to be controlled by means of gain adjustment.

(Example) When the output level of the external sensor is within the range of 1 to 5 V:

- Use terminal [12] designed for voltage input.
- Set the gain (C32 for analog input adjustment) at 200% in order to make the maximum value (5 V) of the external sensor's output correspond to 100%. Note that the input specification for terminal [12] is 0 to 10 V corresponding to 0 to 100%; thus, a gain factor of 200% ($= 10 \text{ V} \div 5 \text{ V} \times 100$) should be specified.

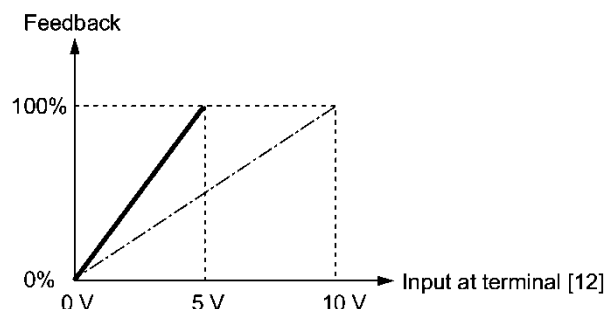

(Example 1) When the output level of the external sensor is ± 7 VDC:

- Use terminal [12] since the voltage input is of bipolar.
- When the external sensor's output is of bipolar, the inverter controls the speed within the range of +100% to -10%. To convert the output +7 VDC to +100%, set the gain (C32 for analog input adjustment) at 143% as calculated below.

$$\frac{10 \text{ V}}{7 \text{ V}} \approx 143\%$$

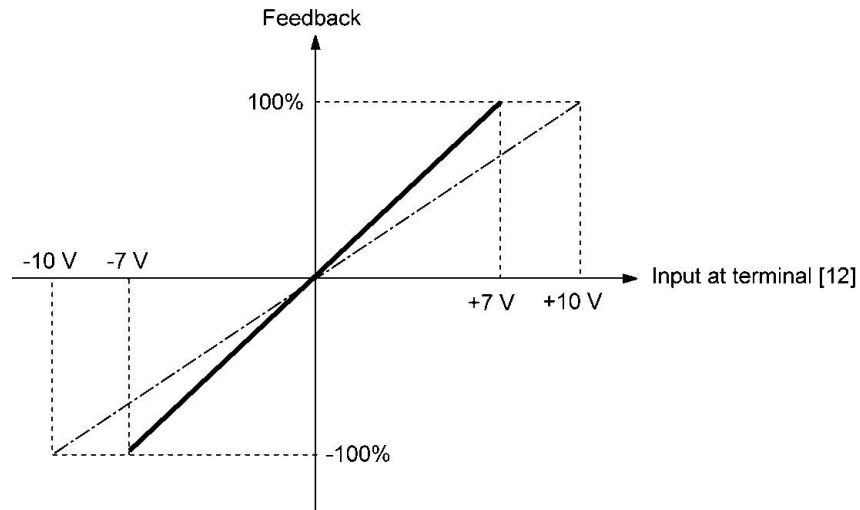

(Example 2) When the output level of the external sensor is 0 to 10 VDC:

- Use terminal [12] designed for voltage input.
- When the external sensor's output is of unipolar, the inverter controls the speed within the range of 0 to 100%.

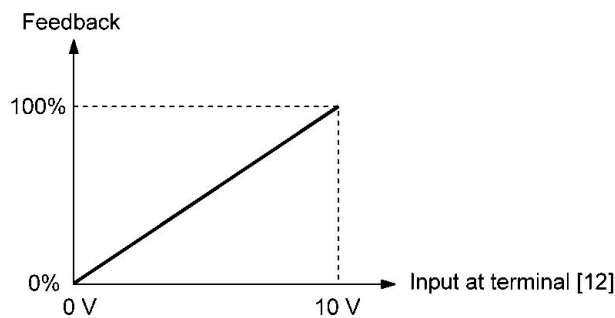

In this example, it is recommended that the dancer reference position be set around the +5 V (50%) point.

PID Display Coefficient and Monitoring

To monitor the PID command and its feedback value, set a display unit, maximum scale, and minimum scale to convert the values into easy-to-understand physical quantities (such as temperature).

- Function code of display unit, maximum scale, and minimum scale, for each terminal

	Display unit	Maximum scale	Minimum scale
Terminal [12]	C58	C59	C60
Terminal [C1]	C64	C65	C66
Terminal [V2]	C70	C71	C72

For the monitor, refer to function code K10.

J103	PID Control 1 (Feedback selection)	J203 (PID Control 2 (Feedback selection))
-------------	---	--

Select a feedback value for PID controls 1 and 2.

- Data setting range: 1 to 14

Data for J103	Data for J203	Function
1	1	PID control 1 feedback value
--	2	PID control 2 feedback value
10	--	Addition (PID control 1 feedback value + PID control 2 feedback value)
11	--	Difference (PID control 1 feedback value - PID control 2 feedback value)
12	--	Average ((PID control 1 feedback value + PID control 2 feedback value) / 2)
13	13	Maximum (Use larger of PID control 1 or 2 feedback values)
14	--	Minimum (Use smaller of PID control 1 or 2 feedback values)

PID control 1 feedback selection block diagram

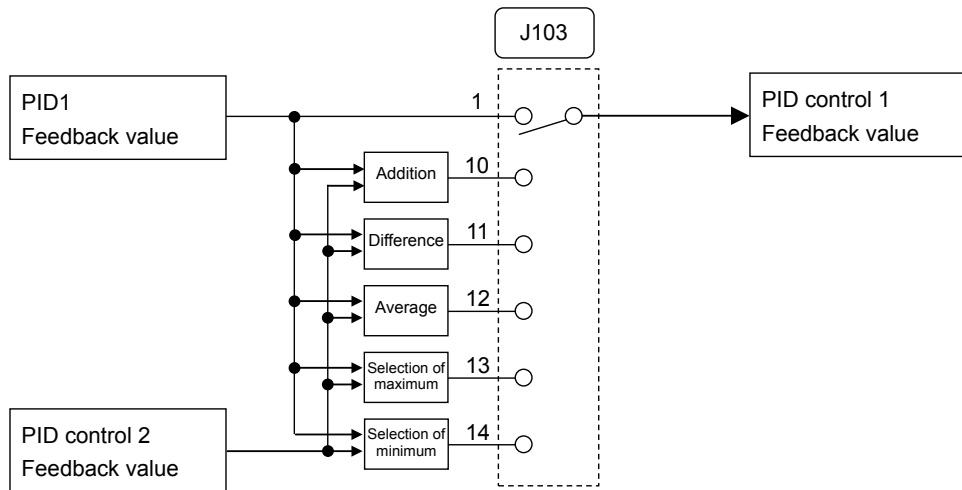

PID control 2 feedback selection block diagram

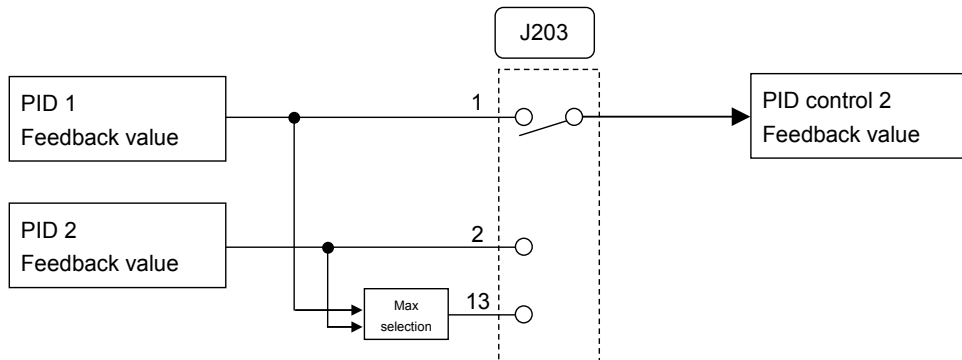

J104**PID Control 1 (Deviation selection)**

Select a deviation value for PID control 1.

- Data setting range: 0 to 2

Data for J104	Function
0	PID control 1 command value (J102) - PID control 1 feedback value (J103)
1	Selection of maximum (Use larger of PID control 1 or 2 deviation)
2	Selection of minimum (Use smaller of PID control 1 or 2 deviation)

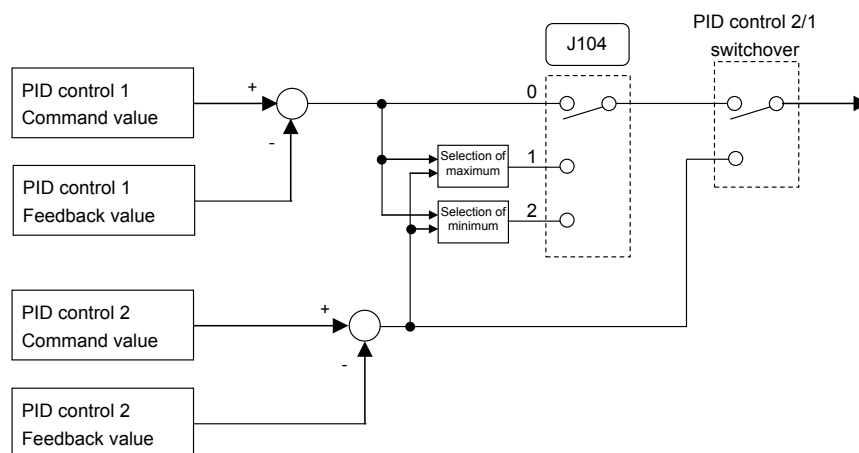
PID control 1 deviation selection section block diagram**J105****PID Control 1 (Display unit)****J205 (PID Control 2 (Display unit))**

Select a display unit for PID control. Set PID control 1 and PID control 2 with function codes J105 and J205 respectively. During PID control, the keypad shows PID command values (SV), feedback values (PV), operation amount (MV), and others. Set the display units for these values.

For monitor display settings, see 5.5.1 Monitoring operation status in Chapter 5 Operation Preparation and Test Operation.

When PID control is to be performed using the same unit and scale as of feedback values, the J105 and J205 settings need not be changed. (Factory default: The unit and scale for feedback values are used.)

Set here when PID control is to be performed using a unit and scale which are different from those for feedback values.

- Data setting range: 1 to 80

Data for J105/J205	Display unit	Data for J105/J205	Display unit	Data for J105/J205	Display unit
0: Inherit	*(Factory default)	23	L/s (flow quantity)	45	mmHg (pressure)
1	No unit	24	L/min (flow quantity)	46	Psi (pressure)
2	%	25	L/h (flow quantity)	47	mWG (pressure)
4	r/min	40	Pa (pressure)	48	inWG (pressure)
7	kW	41	kPa (pressure)	60	K (temperature)
20	m ³ /s (flow quantity)	42	MPa (pressure)	61	°C (temperature)
21	m ³ /min (flow quantity)	43	mbar (pressure)	62	°F (temperature)
22	m ³ /h (flow quantity)	44	bar (pressure)	80	ppm (density)

* The unit and scale for feedback values are used.

 For feedback value selection, see function codes E61 to E63.

 The table below shows function codes to be used for setting a unit and scale for feedback values.

	Display unit	Maximum scale	Minimum scale
Terminal [I2]	C58	C59	C60
Terminal [C1]	C64	C65	C66
Terminal [V2]	C70	C71	C72

J106 J107	PID Control 1 (Maximum scale, Minimum scale) J206, J207 (PID Control 2 (Maximum scale, Minimum scale))
----------------------	---

PID control values can be converted into easily recognizable physical quantity and displayed. Set PID control 1 with function codes J106 and J107 and PID control 2 with function codes J205 and J207.

Set the maximum scale "PID command value/ display for 100% of a PID feedback value" with J106 and J206, and the minimum scale "PID command value/ display for 0% of a PID feedback value" with J107 and J207.

Values to be displayed are as below.

Display value = (PID command value or PID feedback value (%))/100 x (Maximum scale - Minimum scale) + Minimum scale

- Data setting range: (Maximum scale and minimum scale) -999.00 to 0.00 to 9990.00

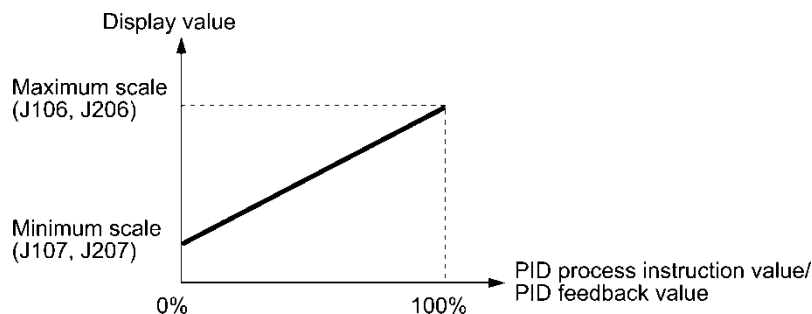

J108 J109	PID Control 1 (Tuning) (Tuning manipulated value)	J110 (PID Control 1 (P (Gain)) J111 (PID Control 1 (I (Integral time)) J112 (PID Control 1 (D (Differential time))
	PID Control 2 (Tuning) (Tuning manipulated value)	J210 (PID Control 2 (P (Gain)) J211 (PID Control 2 (I (Integral time)) J212 (PID Control 2 (D (Differential time))
J208 J209		

In tuning, the inverter forcibly changes MV under actual load to repeatedly make a speed step change several times, monitors changes in the feedback signals, estimates P, I, and D constants for PID control, and writes them to the corresponding function codes automatically.

Depending upon the time constant of feedback signals, short-time or long-time response is available. It is possible to specify step change values as tuning manipulated values.

If a tuning error occurs, the inverter posts the error code to J108 or J208. According to the error contents, take any measure. For P, I, and D constants, refer to the description of the corresponding function codes.

Upon the successful completion of tuning, the inverter continues running under PID control.

■ PID control 1, 2 (Tuning) (J108, J208)

Data for J108, J208	Function
0	Disable (No tuning)
1	For short-time response. Time constant: approx. 30 s or less. (It takes approx. 10 seconds to 8 minutes.)
2	For long-time response. Time constant: approx. 30 s or more. (It takes approx. 30 to 90 minutes.)
If tuning ends abnormally, the inverter posts any of the following values to J108 or J208.	
100	Tuning canceled: Tuning has been canceled due to a run command OFF, PID cancel, fire mode, alarm, etc.
101	Mode unmatched: The time constant was too large or small. If tuning was performed with J108 (J208) being set to "1" ("2"), change the setting from "1" ("2") to "2" ("1") to perform tuning again.
102	MV too small: Almost no change in feedback signals. Increase the setting of J109 (J209) and perform tuning again.
103	MV too large: Too large change in feedback signals. Decrease the setting of J109 (J209) and perform tuning again.
104	MV change: The torque limiter (F40, F41), current limiter (F43) or any other limiter had been activated so that the speed changed and no normal tuning was performed. Disable those limiters, increase their limit values, or increase the setting of J109 (J209). Canceling tuning may also cause this error.
105	PV too small or large: The feedback signal PV is out of the range from 0 to 100% so that no tuning is possible. Investigate the scaling.
106	PV unstabilized: To stabilize PV, increase the setting of J113 (J213) or that of C33 or C38 (Filter time constant).
107	Other factors: Tuning impossible. Tuning has been started with no PV-assigned terminal or during running with the upper limit frequency.

■ PID control 1, 2 (Tuning manipulated value) (J109, J209)

J109 (J209) specifies a speed change value to apply during tuning. The moment you specify the change value, the inverter outputs the "current frequency + J109 (J209) setting."

- Data setting range: 10 to 100% (Maximum frequency = 100%, Initial value 10%)

Requisites for PID tuning

To perform tuning, observe the following beforehand.

- Make a trial run under speed control and confirm that there is no problem for inverter running under actual load.
- Make feedback signal settings and confirm that the inverter can monitor the signal levels.
- Make PID control related settings to make the inverter ready for PID control.
- Since tuning changes the speed step by step, investigate the tuning manipulated value so that PV (feedback signal) does not drop below 0% or exceed 100%. Post the result to J108 (J208).
- Change the speed under speed control beforehand to figure out an approximate time constant of feedback signals for determining whether to perform short-time or long-time response tuning.

PID tuning procedure

- (1) Enter a run command to run the inverter.
- (2) Put the inverter into a feedback signal (PV) stabilized state under PID control.
- (3) Set J108 (J208) to "1" (Short-time response) or "1" (Long-time response)>
- (4) Wait for tuning to complete, checking the progress bar on the LCD monitor.
- (5) If tuning ends normally, the setting of J108 (J208) reverts to "0." If any error occurs, the error code is posted to J108 (J208). Remove the error cause and perform tuning again.

PID tuning notes

- Since tuning changes the speed step by step, to deal with unexpected incidents, get ready to immediately shut down run commands or enter a coast-to-stop command.
- To perform tuning with J108 (J208) being set to "2" (Long-time response), increase the setting of J113 (J213) (Feedback filter) to stabilize feedback signals (PV). Unstabilized PV may result in a long-time waiting state for stabilized PV.

J110	PID Control 1 P (Gain) I (Integral time) D (Differential time) (Feedback filter)	J210 (PID Control 2 (P (gain)))
J111		J211 (PID Control 2 (I (integral time)))
J112		J212 (PID Control 2 (D (differential time)))
J113		J213 (PID Control 2 (feedback filter))

■ P gain (PID control 1: J110 / PID control 2: J210)

J110 specifies the gain for the PID processor.

- Data setting range: 0.000 to 30.000 (times)

P (Proportional) action

An operation in which the MV (manipulated value: output frequency) is proportional to the deviation is called P action, which outputs the MV in proportion to deviation. However, the P action alone cannot eliminate deviation.

Gain is data that determines the system response level against the deviation in P action. An increase in gain speeds up response, but an excessive gain may oscillate the inverter output. A decrease in gain delays response, but it stabilizes the inverter output.

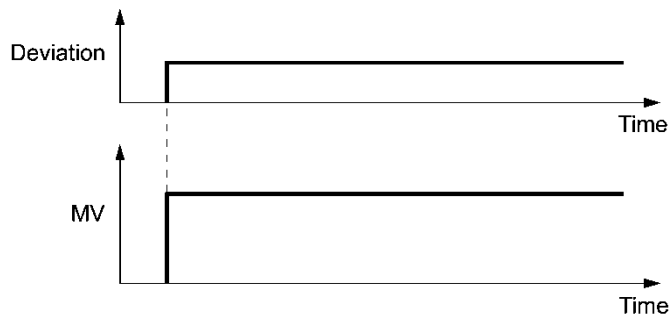

■ I integral time (PID control 1: J111 / PID control 2: J211)

J04 specifies the integral time for the PID processor.

- Data setting range: 0.0 to 3600.0 (s)

0.0 means that the integral component is ineffective.

I (Integral) action

An operation in which the change rate of the MV (manipulated value: output frequency) is proportional to the integral value of deviation is called I action, which outputs the MV that integrates the deviation. Therefore, I action is effective in bringing the feedback amount close to the commanded value. For the system whose deviation rapidly changes, however, this action cannot make it react quickly.

The effectiveness of I action is expressed by integral time as parameter, that is J04 data. The longer the integral time, the slower the response. The reaction to the external disturbance also becomes slow. The shorter the integral time, the faster the response. Setting too short integral time, however, makes the inverter output tend to oscillate against the external disturbance.

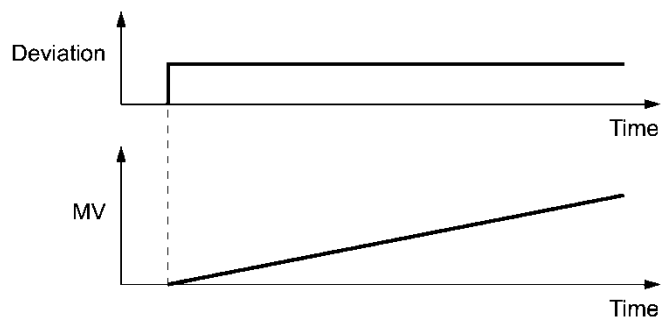

■ D differential time (PID control 1: J112 / PID control 2: J212)

J112/J212 specifies the differential time for the PID processor.

- Data setting range: 0.00 to 600.00 (s)

0.00 means that the differential component is ineffective.

D (Differential) action

An operation in which the MV (manipulated value: output frequency) is proportional to the differential value of the deviation is called D action, which outputs the MV that differentiates the deviation. D action makes the inverter quickly react to a rapid change of deviation.

The effectiveness of D action is expressed by differential time as a parameter. Setting a long differential time will quickly suppress oscillation caused by P action when a deviation occurs. Too long differential time makes the inverter output oscillation more. Setting short differential time weakens the suppression effect when the deviation occurs.

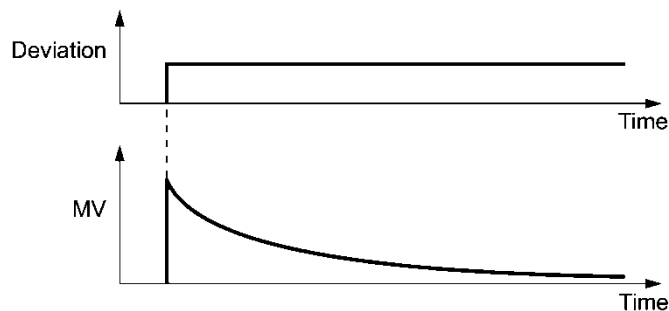

The combined uses of P, I, and D actions are described below.

(1) PI control

PI control, which is a combination of P and I actions, is generally used to minimize the remaining deviation caused by P action. PI control always acts to minimize the deviation even if a commanded value changes or external disturbance steadily occurs. However, the longer the integral time, the slower the system response to quick-changed control.

P action can be used alone for loads with very large part of integral components.

(2) PD control

Under PD control, the moment that a deviation occurs, the control rapidly generates greater MV (manipulated value) than that generated by D action alone, to suppress the deviation increase. When the deviation becomes small, the behavior of P action becomes small.

A load including the integral component in the controlled system may oscillate due to the action of the integral component if P action alone is applied. In such a case, use PD control to reduce the oscillation caused by P action, for keeping the system stable. That is, PD control is applied to a system that does not contain any damping actions in its process.

(3) PID control

PID control is implemented by combining P action with the deviation suppression of I action and the oscillation suppression of D action. PID control features minimal control deviation, high precision and high stability.

In particular, PID control is effective to a system that has a long response time to the occurrence of deviation.

Follow the procedure below to set data to PID control function codes.

It is highly recommended that you adjust the PID control value while monitoring the system response waveform with an oscilloscope or equivalent. Repeat the following procedure to determine the optimal solution for each system.

- Increase the data of function code J110/J210 (PID control P (Gain)) within the range where the feedback signal does not oscillate.
- Decrease the data of function code J111/J211 (PID control I (Integral time)) within the range where the feedback signal does not oscillate.
- Increase the data of J112/J212 (PID control D (Differential time)) within the range where the feedback signal does not oscillate.

Refining the system response waveforms is shown below.

1) Suppressing overshoot

Increase the data of function code J111/J211 (Integral time) and decrease that of J112/J212 (Differential time).

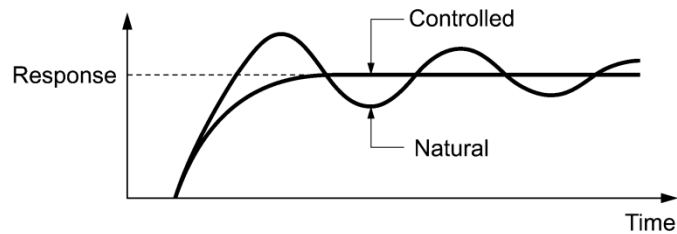

2) Quick stabilizing (moderate overshoot allowable)

Decrease the data of J110/J210 (Gain) and increase that of J112/J212 (Differential time).

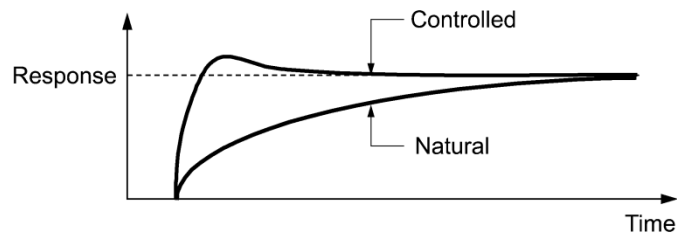

3) Suppressing oscillation whose period is longer than the integral time specified by function code J111/J211

Increase the data of J111/J211 (Integral time).

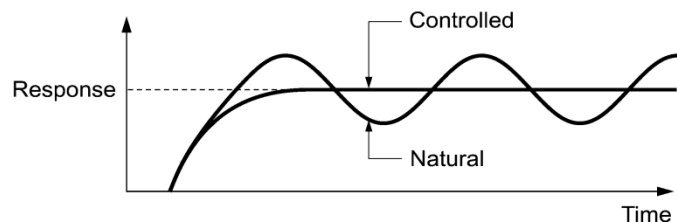

4) Suppressing oscillation whose period is approximately the same as the time specified by function code J112/J212 (Differential time)

Decrease that of J112/J212 (Differential time).

Decrease the data of function code J110/J210 (Gain), if the oscillation cannot be suppressed even though the differential time is set at 0 sec.

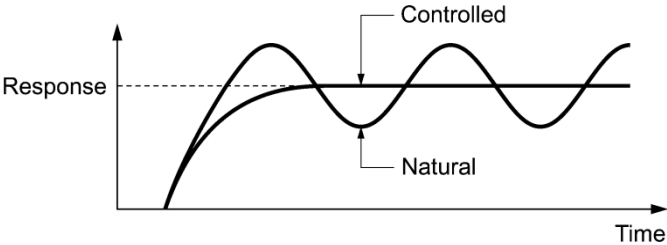

■ Feedback filter (PID control 1: J113 / PID control 2: J213)

J113/J213 specifies the time constant of the filter for feedback signals under PID control.

- Data setting range: 0.0 to 900.0 (s)
- This setting is used to stabilize the PID control loop. Setting too long a time constant makes the system response slow.

J114	PID Control 1 (Anti-reset wind-up)	J214 (PID Control 2 (Anti-reset wind-up))
-------------	---	--

J114 suppresses overshoot under control using a PID processor. Set PID control 1 and PID control 2 with function codes J114 and J214, respectively. As long as the deviation between the PID command and its feedback is out of the preset range, the integrator holds its value and does not perform integration operation.

- Data setting range: OFF (Disable), 0.01 to 9990.00 (Setting range is limited by the maximum and minimum scales.)

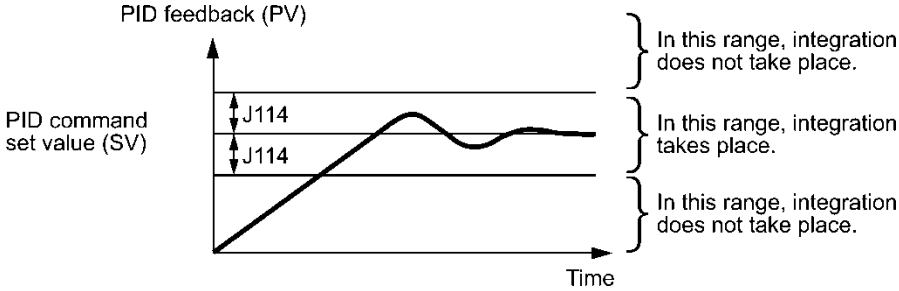

J118 J119	PID Control 1 (Upper limit of PID process output) (Lower limit of PID process output) J218 (PID Control 2 (upper limit of PID process output)) J219 (PID Control 2 (upper limit of PID process output))
----------------------------	--

The upper and lower limiters can be specified to the PID output, exclusively used for PID control. Set PID control 1 with function codes J118 and J119 and PID control 2 with function codes J218 and J219. The settings are ignored when terminal command **Hz/PID** ("Cancel PID control") is ON and the inverter runs at the reference frequency previously specified. (E01 to E07, data = 20)

■ PID Control 1 (Upper limit of PID process output) (J118, J218)

J118 specifies the upper limit of the PID processor output limiter in %. If you specify "Inherit," the setting of the frequency limiter (High) (F15) serves as the upper limit.

■ PID Control 1 (Lower limit of PID process output) (J119, J219)

J119 specifies the lower limit of the PID processor output limiter in %. If you specify "Inherit," the setting of the frequency limiter (Low) (F16) serves as the lower limit.

J121 J122 J124	PID Control 1 (Alarm output selection) (Upper level alarm (AH)) (Lower level alarm (AL)) J221 (PID Control 2 (Alarm output selection)) J222 (PID Control 2 (Upper level alarm (AH))) J224 (PID Control 2 (Lower level alarm (AL)))
---	---

The inverter can output absolute-value and deviation alarms associated with PID control. To output alarms, digital output signals **PID-ALM** or **PV1-ALM** and **PV2-ALM** must be assigned to any of E20 through E24 and E27 (data = 42 and 201, 203). To generate the "light alarm," light alarm selection 4 (H184) must be set to the first bit. However, even if light alarm selection 4 (H184) is not set, the above-mentioned digital output signal can be isolated. Please refer to pages describing function codes H181 through H184 for a detailed explanation of setting the light alarm.

J121 and J221 specify the alarm types. J122, J222 and J124, J224 specify the upper and lower limits for alarms. J223 and J225 set their upper and lower output hiss ranges.

■ PID controls 1 and 2 (Alarm output selection) (J121, J221)

J121 and J221 specify the alarm type. The table below lists the alarms selectable.

The physical quantities that can be set depend on the display units and scale.

Data for J121	Data for J221	Alarm	Description
0	0	Absolute-value alarm	While $PV < AL$ or $AH < PV$, PID-ALM is ON.
1	1	Absolute-value alarm (with Hold)	Same as above (with Hold)
2	2	Absolute-value alarm (with Latch)	Same as above (with Latch)

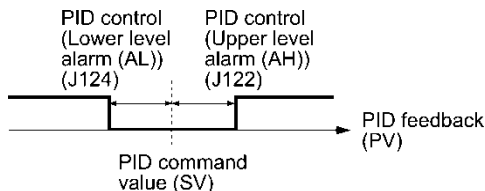
Data for J121	Data for J221	Alarm	Description
3	3	Absolute-value alarm (with Hold and Latch)	Same as above (with Hold and Latch)
--	50	Absolute-value alarm (PID control cancel)	Same as above (PID control cancel) This function is available only on PID control 2
4	4	Deviation alarm	While $PV < SV - AL$ or $SV + AH < PV$, PID-ALM is ON. 
5	5	Absolute-value alarm (with Hold)	Same as above (with Hold)
6	6	Absolute-value alarm (with Latch)	Same as above (with Latch)
7	7	Absolute-value alarm (with Hold and Latch)	Same as above (with Hold and Latch)

Hold: During the power-on sequence, the alarm output is kept OFF (disabled) even when the monitored quantity is within the alarm range. Once it goes out of the alarm range, and comes into the alarm range again, the alarm is enabled.

Latch: Once the monitored quantity comes into the alarm range and the alarm is turned ON, the alarm will remain ON even if it goes out of the alarm range. To release the latch, perform a reset by using the  key or turning the terminal command **RST** ON. Resetting can be done by the same way as resetting an alarm.

PID control cancel:

While **PID-ALM** is ON, as when **H_z/PID** is ON, switches from PID control to manual frequency setting (operates according to multi-frequency, keypad, analog input or other set frequencies).

■ PID control 1, 2 (upper level alarm (AH)) (J122, J222)

Set the upper limit (AH) for alarms with physical quantity.

- Data setting range: -999.00 to 0.00 to 9990.00

■ PID control 2 (upper level alarm detection hysteresis range (J223))

Set the hysteresis range for the upper limit (AH) detection (J222) for alarms with physical quantity. Please set a value smaller than the upper limit alarm (AH) (J222).

- Data setting range: 0.00 to 9990.00

■ PID control 1, 2 (lower level alarm (AL)) (J124, J224)

Set the lower limit (AL) for alarms with physical quantity.

- Data setting range: -999.00 to 0.00 to 9990.00

■ PID control 2 (lower level alarm detection hysteresis range (J225))

Set the hysteresis range for the lower limit (AL) detection (J222) for alarms with physical quantity. Please set a value larger than the lower limit alarm (AL) (J224).

- Data setting range: 0.00 to 9990.00

Upper level alarm (AH) and lower level alarm (AL) also apply to the following alarms.

Alarm	Description	How to handle the alarm:	
		Select alarm output (J121, J221)	Parameter setting
Upper limit (absolute)	ON when $AH < PV$	Absolute-value alarm	AL = 0
Lower limit (absolute)	ON when $PV < AL$		AH = 100%
Upper limit (deviation)	ON when $SV + AH < PV$	Deviation alarm	AL = 100%
Lower limit (deviation)	ON when $PV < SV - AL$		AH = 100%
Upper/lower limit (deviation)	ON when $ SV - PV > AL$		AL = AH
Upper/lower range limit (deviation)	ON when $SV - AL < PV < SV + AL$	Deviation alarm	A negative logic signal should be assigned to PID-ALM .
Upper/lower range limit (absolute)	ON when $AL < PV < AH$	Absolute-value alarm	
Upper/lower range limit (deviation)	ON when $SV - AL < PV < SV + AH$	Deviation alarm	

J127 J128 J129 J130 J131	PID Control 1 (Feedback failure detection (Mode selection)) (Feedback failure continuation duration) (Feedback failure upper-limit) (Feedback failure lower-limit) (Feedback failure detection time) J227 (PID control 2 (Feedback failure detection (Mode selection))) J228 (PID control 2 (Feedback failure continuation duration)) J229 (PID control 2 (Feedback failure upper-limit)) J230 (PID control 2 (Feedback failure lower-limit)) J231 (PID control 2 (Feedback failure detection time))
--------------------------------------	---

PID control 1, 2: Abnormal feedback values (PV values) can be detected. When PV signals' abnormal level (upper limit: J129, J229 / lower limit: J130, J230) is continued for the set time (J131, J231), failure is recognized.

If Mode selection (J127, J227) is 3 through 6, when failure has been detected, the speed is reduced followed by stop of the operation, based on the Mode selection (J127, J227), after the failure continuation duration value (J128, J228) elapses. If the PV value is returned to the normal range (upper limit: J129, J229 / lower limit: J130, J230) during operations for failure continuation duration, PID control is restored.

■ PID control 1, 2 (feedback failure detection Mode selection) (J127, J227)

Select an operation to be performed after failure is detected.

Physical values that can be set depend on display unit and scale.

- Data setting range: 0 to 6

Data for J127	Data for J227	J128, J228	Operation description
0	0	Disable	Disable: Turns ON digital output signals (PV1-OFF) and (PV2-OFF) and continues operation.
1	1	Disable	Enable: Free run stop (PV1, PV2 trip)
2	2	Disable	Enable: Deceleration and stop (PV1, PV2 trip) *After deceleration and stop, PV1, PV2 trip
3	3	Enable	Enable: Continuation of operation at the maximum frequency (upper limit frequency)
4	4	Enable	Enable: Continuation of operation at the minimum frequency (lower limit frequency)
5	5	Enable	Enable: Continuation of operation at the frequency used when failure is detected.
6	--	Enable	Enable: Shift to PID control 2 (PID control 1 is restored when failure is recovered from.) In this case, even if (PID2/1) is not allocated, even if (PID2/1) is OFF, transitions to PID control 2. However, in the case of J201 =0 (disable), operates as J127 = 1.

📖 Operations regarding PID1, 2 feedback failure "PV1-OFF" and "PV2-OFF" can be monitored from external equipment, using Y1 to Y4, Y5A/C, or 30A/B/C. Set function codes E20 to E24 or E27 data to 202, 204.

■ PID control 1, 2 (feedback failure continuation duration) (J128, J228)

Set how long operation which conforms to Mode selection (J127, J227) is to be continued after failure is detected. When this time elapses, the inverter decelerates to stop. (J127, J227: 3 to 6)

- Data setting range: Cont., 0 to 3600 (s)

Cont. (Mode selection: continuation of operation specified with J127, J227. PV1, PV2 trip after stop (output shutoff).)

■ PID control 1, 2 (feedback failure upper-limit) (J129, J229)

Set the upper limit for failure with physical quantity. Settable physical quantity conforms to display unit (J105) and scale (J106, J107).

- Data setting range: -999.00 to 0.00 to 9990.00, Auto = 105%

■ PID control 1, 2 (feedback failure lower-limit) (J130, J230)

Set the lower limit for failure with physical quantity. Settable physical quantity conforms to display unit (J105) and scale (J106, J107).

- Data setting range: -999.00 to 0.00 to 9990.00, Auto = -5%

■ PID control 1, 2 (feedback failure detection time) (J131, J231)

Set abnormal-level (upper limit: J129, J229 / lower limit: J130, J230) continuation duration. When the set continuation duration value elapses, failure is recognized.

- Data setting range: 0 to 300.0 (s)

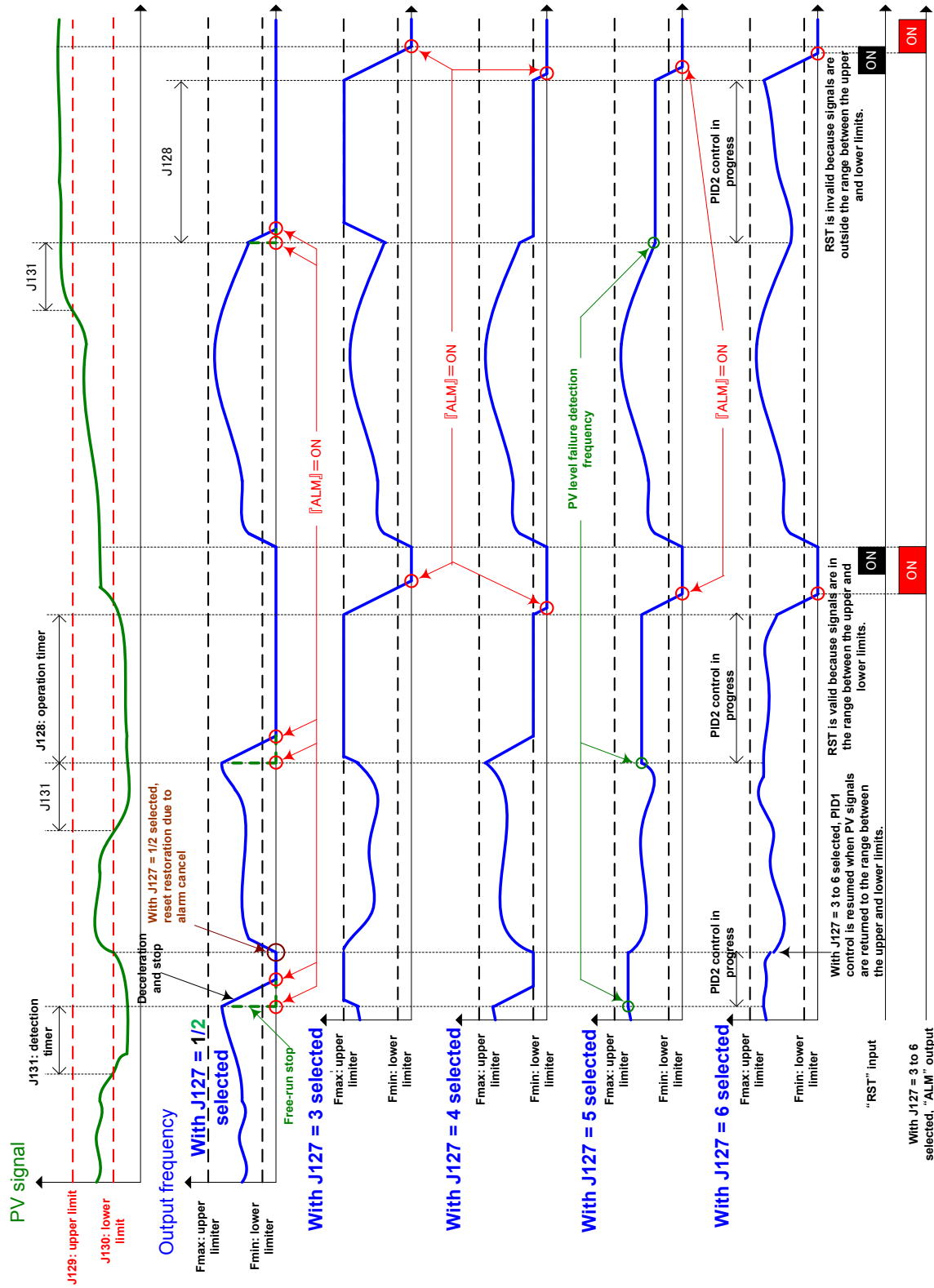

J136 J137 J138	PID Multistep Command (Multistep command 1) (Multistep command 2) (Multistep command 3)
---	--

Under PID control, a multistep frequency command can be specified as a preset value (3 different frequencies). This command is available under PID control 1 and 2.

- PID command

<i>PID-SS2</i>	<i>PID-SS1</i>	Command
OFF	OFF	Command by J102
OFF	ON	J136 (Multistep command 1)
ON	OFF	J137 (Multistep command 2)
ON	ON	J138 (Multistep command 3)

- Data setting range: -999.00 to 0.00 to 9990.00

J149 J150 J151 J152 J153 J154 J156 J157 J158 J159 J160	Slow Flowrate Stop Function (Mode selection) (Operation level) (Elapsed time) (Auto-operation frequency lower-limit) (Pressurization starting frequency) (Pressurizing time) (Initiation inhibition time) (Cancel frequency) (Cancel deviation level 1) (Cancel delay timer) (Cancel deviation level 2)	J249 J250 J251 J256 J257 J258 J259 J260
---	--	--

The inverter can be stopped when the discharge pressure of the pump rises, causing the volume of water to decrease. When the discharge pressure has increased, decreasing the reference frequency (output of the PID processor) below the stop frequency for slow flowrate level (for PID control 1, J150; for PID control 2, J250) for the period of slow flowrate level stop latency (for PID control 1, J151; for PID control 2, J251), the inverter decelerates to stop. However, PID control itself continues to operate. The inverter resumes operation when the discharge pressure decreases, increasing the reference frequency (output of the PID processor) above the cancel frequency (for PID control 1, J157; for PID control 2, J257) or when SV (command value) minus PV (feedback value) exceeds the cancel deviation level (for PID control 1, J158/J160; for PID control 2, J258/J260).

Specifying J153 (Pressurization starting frequency) and J154 (Pressurizing time) enables pressurization control when the frequency drops below the level specified by J150 (Stop frequency for slow flowrate) after the period specified by J151. During the pressurization, the PID control is in the hold state. This function prolongs the stopping time of equipment with a bladder tank by pressurizing immediately before the frequency drops below the level at which the inverter stops the motor, thus enabling energy saving operation.

Because the pressurization starting frequency can be specified with a parameter, pressurization setting suitable for the equipment is possible.

■ Slow flowrate stop function (Mode selection) (J149, J249)

Select slow flowrate function operation. Set PID control 1 and PID control 2 with function codes J149 and J249 respectively. As an item for judging about slow flowrate level stop, you can select PID control operation quantity (MV) or feedback value (PV). If slow flowrate level stop (mode selection) (J149, J249) = automatic operation 1 (11, 12), the feedback value (PV) if the deviation goes from plus to minus or the output frequency are stored, and that value is taken as the stop condition for the running level. If the slow flowrate level stop (mode selection) (J149, J249) = automatic operation 2 (21, 22), when the flowrate sensor is turned from ON to OFF, the feedback value (PV) or the output frequency are stored, and that value is taken as the stop condition for the running level. (In this case, the flowrate sensor must be set; refer to the page on J163 for details.) Also, during the above-mentioned automatic operation, if only PID control 1 is enabled and PID control 2 is selected at (PID2/1), the value is not stored and the stop condition is determined in accordance with the J249 setting.

Note Even if the slow flowrate level stop (mode selection) (J149, J249) is set to automatic operation 2 (21, 22), function code J163: 0 (analog input selection), E01 to E07: 131 (flowrate switch) is disabled when unset.

Also, if function code J163: 0 (analog input selection) is set, if the ON/OFF level of J164, J165 is OFF, the function code is disabled.

- Data setting range: 0 to 22

Data for J149	Data for J249	Operation description	Stop condition
0	0	Disable (display of OFF)	-
1	1	Manual operation (stop judgment: MV)	Operation quantity (MV) ≤ operation level (J150)
2	2	Manual operation (stop judgment: PV)	Feedback value (PV) ≤ operation level (J150)
11	-	Auto operation 1 (stop judgment: MV): Deviation detection method	Operation quantity (MV) ≤ deviation value automatically detected
12	-	Auto operation 1 (stop judgment: PV): Deviation detection method	Feedback value (PV) ≥ deviation value automatically detected
21	-	Auto operation 2 (stop judgment: MV): Flowrate sensor detection method	Operation quantity (MV) ≤ flowrate automatically detected
22	-	Auto operation 2 (stop judgment: PV): Flowrate sensor detection method	Feedback value (PV) ≥ flowrate automatically detected

With J149 = 1, 11, or 21 (frequency) selected

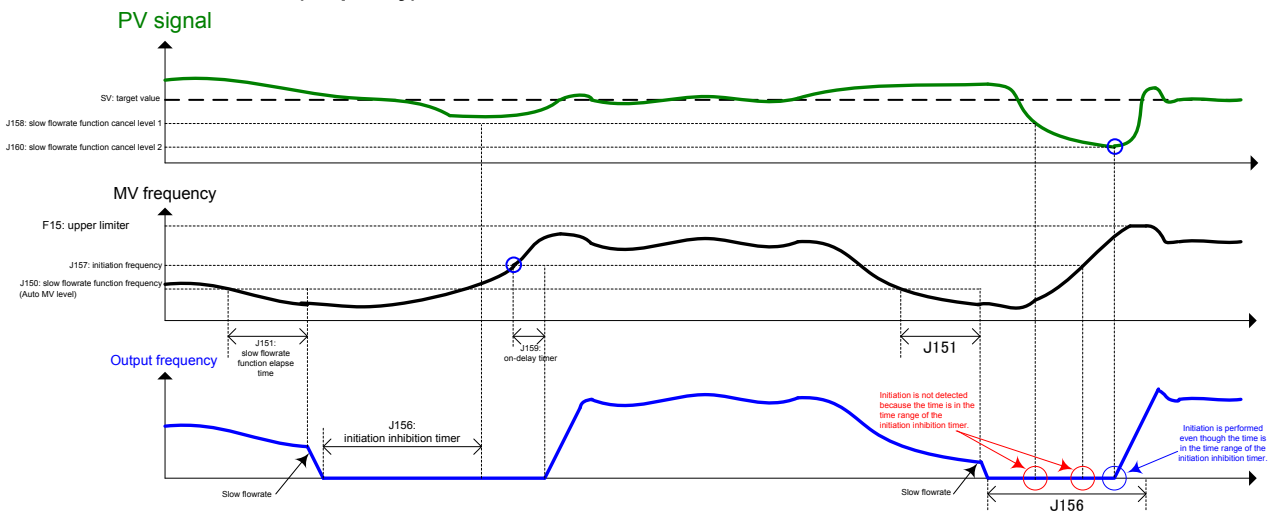

With J149 = 2, 12, or 22 (frequency) selected

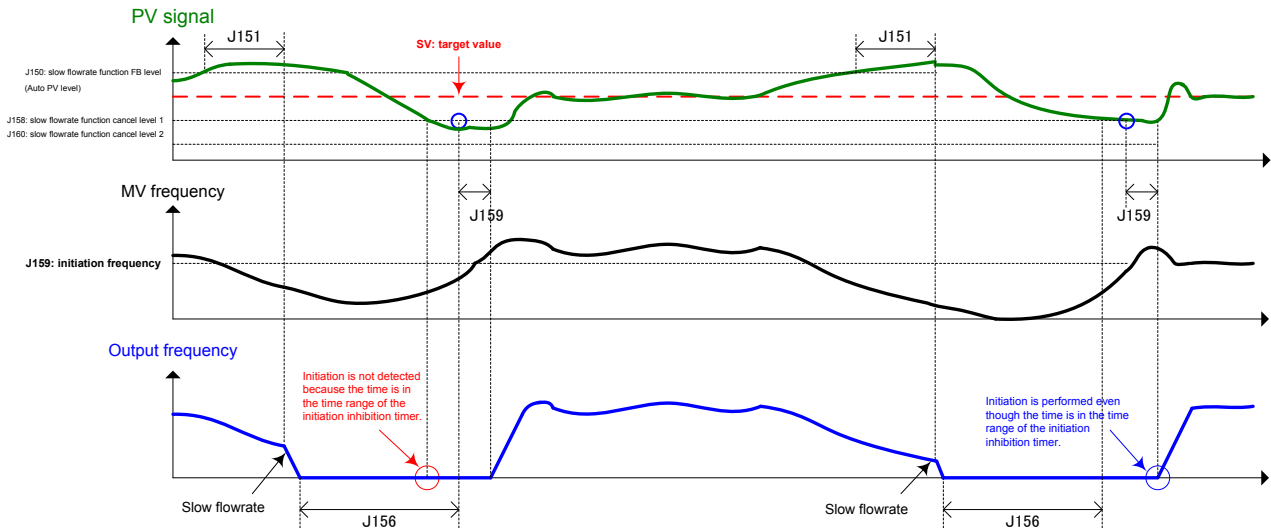

■ **Slow flowrate stop function (Operation level) (J150, J250)**

Select an operation level to be used as the slow flowrate stop condition. Set PID control 1 and PID control 2 with function codes J150 and J250 respectively.

- Data setting range: See the table below.

Data for J149 and J249	Setting range for J150 and J250	Remarks
1, 11, 21	Auto	Automatically calculates the best value from the maximum frequency (F03)
2, 12, 22		Automatically calculates the best value from SV
1, 11, 21	0.0 to 120.0 Hz	Setting with a frequency
2, 12, 22	0.00 to 9990.00	Setting with physical quantity PID control 1: display unit (J105), scale (J106, J107) PID control 2: display unit (J205), scale (J206, J207) (Setting range is limited by maximum scale and minimum scale.)

■ **Slow flowrate stop function (Elapsed time) (J151, J251)**

Set time delay from PID output's satisfaction of the stop conditions specified with Mode selection (J149, J249) and operation level (J150, J250) until the inverter starts to decelerate and stop. Set PID control 1 and PID control 2 with function codes J151 and J251 respectively.

- Data setting range: 0 to 60 (s)

■ **Slow flowrate stop function (Auto-operation frequency lower-limit) (J152)**

J152 specifies the lower limit of the stop judgment level (output frequency) to be recorded by shutoff operation when J149 = 11 or 21.

- Data setting range: 0.0 to 120.0 (Hz)

■ **Slow flowrate stop function (Pressurization starting frequency) (J153)**

- Data setting range: 0.0 to 120.0 (Hz)

■ Slow flowrate stop function (Pressurizing time) (J154)

- Data setting range: 0 to 60 (s)

Specifying J153 (Pressurization starting frequency) and J154 (Pressurizing time) enables pressurization control when the frequency drops below the level specified by J149 (Stop frequency for slow flowrate) for the period specified by J151. During the pressurization, PID control is in the hold state.

This function prolongs the stopping time of equipment with a bladder tank by pressurizing immediately before the frequency drops below the level at which the inverter stops the motor, thus enabling energy saving operation.

Because the pressurization starting frequency (J153) can be specified with a parameter, pressurization setting suitable for the equipment is possible.

For pressurization control, see the chart below.

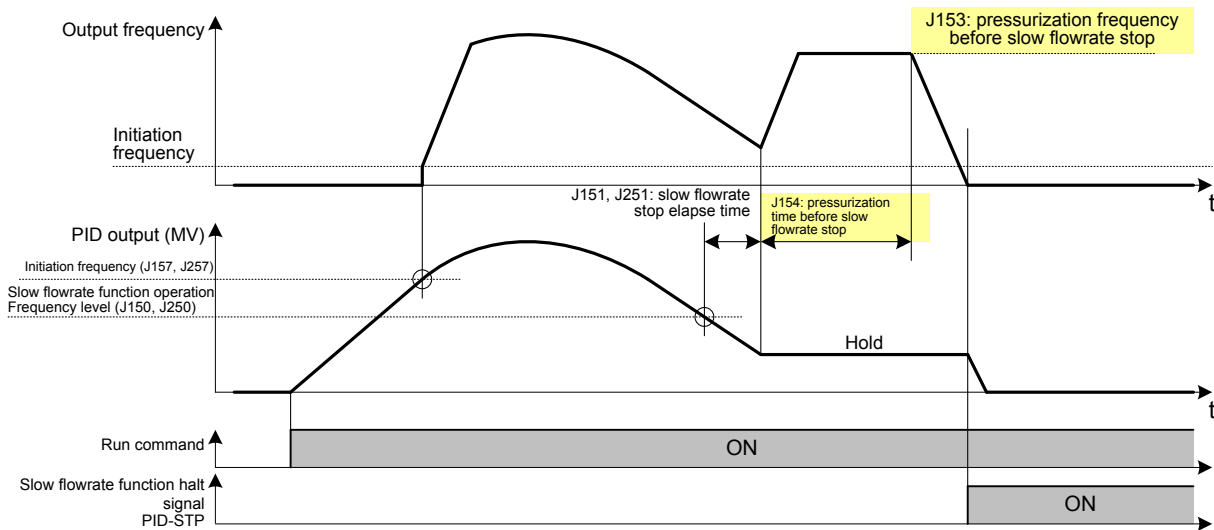

■ Slow flowrate stop function (Initiation inhibition time) (J156, J256)

Set how long initiation is to be inhibited after stop due to slow flowrate. Set PID control 1 and PID control 2 with function codes J156 and J256 respectively.

- Data setting range: 0 to 3600 (s)

■ Slow flowrate stop function (Cancel frequency) (J157, J257)

Set a cancel frequency. The cancel (start) conditions for slow flowrate level stop are as below. Set PID control 1 and PID control 2 with function codes J157 and J257 respectively.

- Data setting range: 0.0 to 120.0 (Hz), OFF

When the initiation inhibition time (J156, J256) elapses	When the initiation inhibition time (J156, J256) does not elapse
If one of the conditions below is satisfied, the function is canceled. <ul style="list-style-type: none"> • Operation quantity (MV) \geq Cancel frequency (J157, J257) • SV - PV \geq Cancel deviation level 1 (J158, J258) 	<ul style="list-style-type: none"> • SV - PV \geq Cancel deviation level 1 (J160, J260)

* MV: operation quantity SV: command value PV: feedback value

<Slow flowrate cancel condition block diagram>

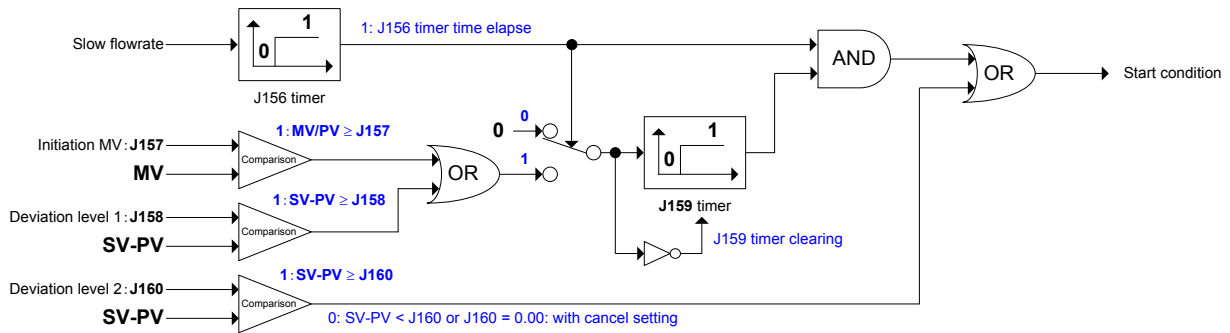

■ Slow flowrate stop function (Cancel deviation level 1) (J158, J258)

Set a cancel deviation level to be used as a cancel condition. Set PID control 1 and PID control 2 with function codes J158 and J258 respectively.

- Data setting range: 0.01 to 9990.00, OFF

■ Slow flowrate stop function (Cancel delay timer) (J159, J259)

Set time delay from satisfaction of slow flowrate's cancel conditions (J157, J257) until initiation of the inverter. Set PID control 1 and PID control 2 with function codes J159 and J259 respectively.

- Data setting range: 0 to 3600 (s)

■ Slow flowrate stop function (Cancel deviation level 2) (J160, J260)

In a case where water supply is needed until the initiation inhibition time (J156, J256) elapses, set a cancel deviation level as a cancel (initiation) condition for water stoppage prevention. Set PID control 1 and PID control 2 with function codes J160 and J260 respectively.

Set a value so that the following is resulted: cancel deviation level 1 (J158, J258) < cancel deviation level 2 (J160, J260).

If a value is set so that the cancel deviation level 1 (J158, J258) exceeds the cancel deviation level 2 (J160, J260), the cancel deviation level 2 (J160, J260) is used as the cancel condition even when the initiation inhibition time (J156, J256) elapses.

- Data setting range: 0.01 to 9990.00, OFF

■ Assignment of PID-STP ("Motor stopped due to slow flowrate under PID control") (function codes E20 to E24 and E27, data = 44)

With respect to PID slow flowrate stop, ON signals are output when the inverter stops due to the slow flowrate during PID control. When signals which indicate inverter stop status are needed, PID-STP has to be assigned.

J163 J164 J165 J166	Flowrate Sensor (Input selection) (ON level) (OFF level) (Input filter)
--	--

Flowrate sensor judgment can be used for slow flowrate stop, dry pump detection and end of curve detection. The flowrate sensor uses digital signal ON (flowing) and OFF (not flowing) as detection results. The flowrate sensor can be used for detection with either a digital input or an analog input. If not set, the flowrate sensor is taken to be OFF.

If the flowrate sensor is set with a digital input, the digital input **FS** is the flowrate sensor.

If the flowrate sensor is set with an analog input, the results of comparing the analog value selected for the flowrate sensor (input selection) (J163) and flowrate sensor (ON level) (J164), (OFF level) (J165) becomes the flowrate sensor.

■ Flowrate sensor (input selection) (J163)

- Data setting range: 0 to 25

Data for J163	Content	Data for J163	Content
0 Inherit	The analog input selection is followed (E61, E62, and E63).	22	m ³ /h
1	PV1 (feedback value)	23	L/s
20	m ³ /s	24	L/min
21	m ³ /min	25	L/h

* Data 20 or larger is to be used for connection of customizable logic.

■ Flowrate sensor (ON level) (J164), (OFF level) (J165)

If the flowrate sensor is set with an analog input, the flowrate sensor ON/OFF levels are set. If the analog input value exceeds the flowrate sensor (ON level) (J164), the flowrate sensor is recognized as ON. If the analog input value is below that of the flowrate sensor (OFF level) (J165), the flowrate sensor is recognized as OFF.

- Data setting range: 0.00 to 9990.00, OFF (Setting range is limited by maximum scale and minimum scale.)

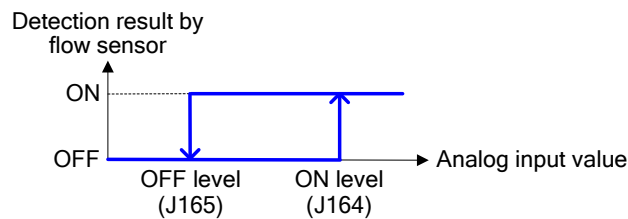

■ Flowrate sensor (Input filter) (J166)

Sets the input filter if flowrate switches are connected to terminals X1 to X7. If the flowrate sensor has an analog input, this filter does not work.

📖 Please set the flowrate switch **FS** (data = 131) to function codes E01 to E07.

- Data setting range: 0.00 to 5.00 (s)

J188	Filter Clogging Prevention/Anti Jam Function (Input selection)
J189	Filter Clogging Prevention Function (Reverse operation cycle time)
J190	Filter Clogging Prevention Function (Load resistance current)
J191	Filter Clogging Prevention Function (Load resistance PV signal)
J192	Filter Clogging Prevention Function (Load resistance detection timer)
J193	Filter Clogging Prevention/ Anti Jam Function (Reverse rotation running frequency)
J194	Filter Clogging Prevention/ Anti Jam Function (Reverse rotation running time)
J195	Filter Clogging Prevention/ Anti Jam Function (Number of allowable reverse runs)

<Anti jam function>

When organic substance such as sand jams in the impeller of a submersible pump, the anti jam function expels it through reverse rotation operation and then starts normal water supply through normal rotation operation.

<Filter clogging prevention function>

When a fan's filter is clogged with coarse-grained dust, the filter clogging prevention function expels the dust through reverse rotation operation, break it up, and then starts air blow through normal rotation operation.

Note Only PID control 1 is valid for the filter clogging prevention function. When switch from PID control 1 to PID control 2 is made, count values for the number of times and time length for the filter clogging prevention function are cleared.

■ Filter clogging prevention/Anti jam function (input selection) (J188)

- Data setting range: 0 to 3

Data for J188	Operation description
0	Disable
1	Enable: Alarm (anti jam protection, inverter stop with rLo trip)
2	Enable: Alarm (filter clogging trouble, inverter stop with FoL trip)
3	Enable: While warning (filter clogging trouble) is output, operation is continued.

<J188 = 1 (alarm: anti jam protection, inverter stop with rLo trip)>

When overcurrent protection (OC) becomes active during normal rotation operation, the anti jam function operates. The number of reset times is counted up, and PID control is canceled after the reset interval (H05). Then retry operation is performed with the reverse operation frequency (J193) during the reverse rotation operation time (J194), followed by restoration through normal rotation operation (PID control).

When overcurrent protection (OC) becomes active during reverse rotation operation, retry operation is performed through normal rotation operation (PID control) after the reset interval (H05). When overcurrent protection (OC) becomes active again after the number of reset times reaches the number of allowed reverse operations (J195), alarm stop (rLo trip) is resulted.

The number of reset times is cleared when operation is continued during the number-of-reset-times clearing time (H104) after the reverse rotation operation frequency (J193) is reached at the time of reverse rotation operation.

Note

- When overcurrent protection (OC) becomes active during reverse rotation operation, the number of reset times is not counted up.
- To use this function, you must disable the function that prevents generation of overcurrent protection (OC). To do so, the following settings are needed.
Torque limit value 1 (drive) (F40) = OFF: Disable
Current limiting (mode selection) (F43) = 0: Disable
Torque limit value 2 (drive) (E16) = OFF: Disable
Instantaneous overcurrent limiting (mode selection) (H12) = 0: Disable

Example: With H04 = J195 = 2 (number of times) selected

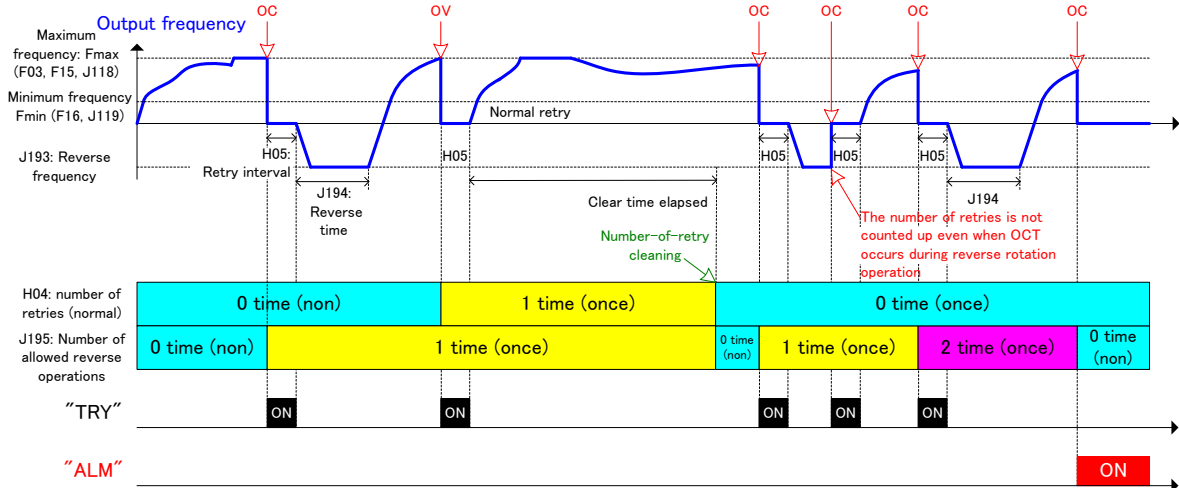

<J188 = 2 (alarm: filter clogging trouble, inverter stop with FoL trip)>

When the amount of air which passes through the filter decreases due to filter clogging, the rotation load of the air-cooling fan decreases, causing load resistance current values to decrease. Contrary, pressure increase is induced before the filter because air does not pass through smoothly. This characteristic is detected with the condition in (1) or (2) below. When one of the conditions is satisfied and the load resistance detection timer value (J192) elapses, the filter clogging prevention function operates.

- (1) With load resistance current selected
"Output current \geq load resistance current (J190)"
- (2) With load resistance PV signal selected
"Feedback PV value \geq load resistance PV signal (J191)"

When the filter clogging prevention function operates, PID control is canceled, and reverse rotation operation is performed with the reverse rotation operation frequency (J193). (The number of filter clogging is counted up.)

After reverse rotation operation is started and continued during the reverse rotation operation time (J194), normal rotation operation (PID control) is restored. When filter clogging is detected again after the number of reverse rotation operations reaches the number of allowed reverse operations (J195), alarm stop (FoL trip) is resulted.

<J188 = 3 (While warning (filter clogging trouble) is output, operation is continued.)>

While the detection operation is the same as the one in (2) above, warning is output and operation is continued (rather than alarm stop) when filter clogging is detected again after the number of allowed reverse operations (J195) is reached. Operation for the filter clogging prevention function is performed and reverse rotation operation is continued.

<Operation example of load resistance current level detection with J188 = 2 (filter clogging prevention) and J195 = 2 (number of times) selected>

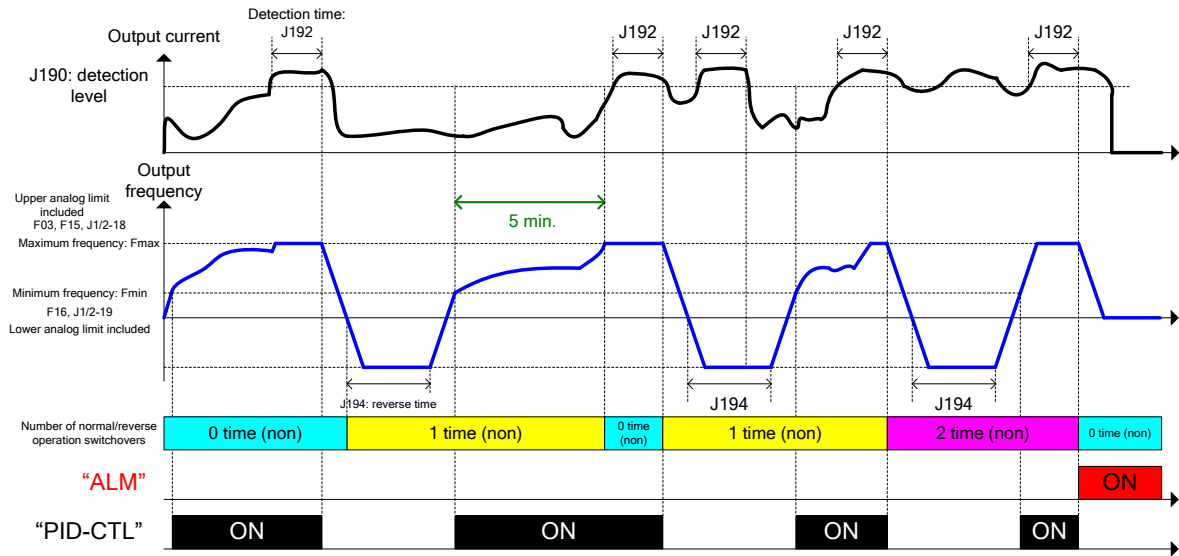

<Operation example of PV signal level detection with J188 = 2 (filter clogging prevention) and J195 = 2 (number of times) selected>

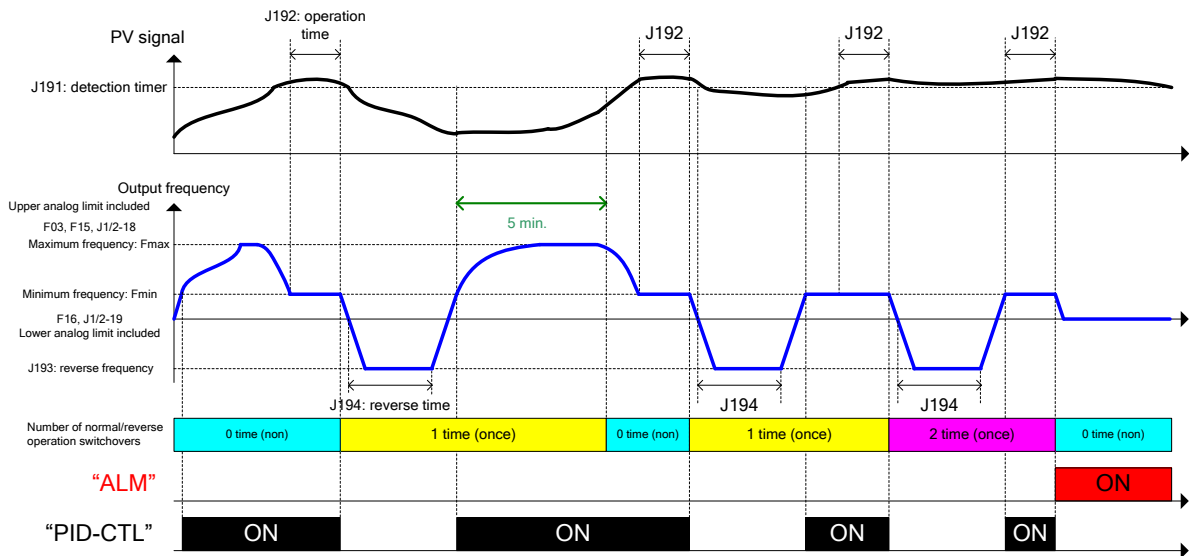

■ Filter clogging prevention (Reverse operation cycle time) (J189)

PID control is canceled and reverse rotation operation is performed with the reverse rotation operation frequency (J193) in accordance with the reverse operation cycle time (J189). After reverse rotation operation is continued during the reverse rotation operation time (J194), normal rotation operation (PID control) is restored. While this function is operating, the detection processing regarding input selection "J188 = 2/3" is disabled. When reverse rotation operation is being performed with input selection "J188 = 2/3" made active, this function is canceled and disabled until the next cycle time.

- Data setting range: 1 to 10000 (h), OFF

<Reverse cycle operation example with J188 = 2 or 3 (filter clogging prevention) and J189 ≠ 0 selected>

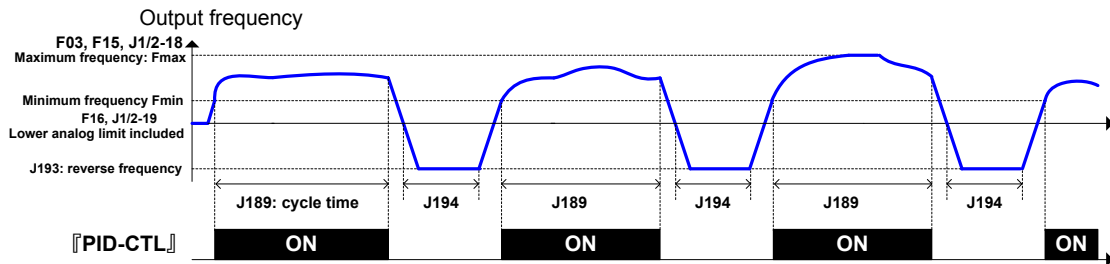

- Filter clogging prevention (Load resistance current) (J190)
Set load resistance current as a detection condition.

 - Data setting range: OFF (Disable), 1% to 150% of the inverter rated current
- Filter clogging prevention (Load resistance PV signal) (J191)
Set load resistance PV signal as a detection condition, with physical quantity.

 - Data setting range: -999.00 to 0.00 to 9990.00, OFF
(The setting range is limited by the maximum scale and minimum scale.)
- Filter clogging prevention (Load resistance detection timer) (J192)
Set how long the detection condition is to be continued (load resistance detection timer).

 - Data setting range: 0 to 600 (s)
- Filter clogging prevention/Anti jam (Reverse rotation operation frequency) (J193)
Set output frequency for reverse rotation operation.

 - Data setting range: 0.0 to 120.0 (Hz)
- Filter clogging prevention/Anti jam (Reverse rotation operation time) (J194)
Set how long reverse rotation operation it to be performed.

 - Data setting range: 0 to 600 (s)
- Filter clogging prevention/Anti jam (Number of allowed reverse operations) (J195)
Set the number of times by which reverse rotation operation is to be allowed. After the number of allowed reverse operations is reached, the individual prevention functions operate when the detection condition is satisfied next time.

 - Data setting range: 1 to 10 (times)

This function is to be used mainly for fan control of a cooling tower. On days when outside air temperature (humidity) is especially high, the wet-bulb temperature becomes higher than the set temperature, preventing water temperature from reaching the set temperature. As a result, the fan continues operating at high speed, resulting in no energy-saving effect. With this function activated, the wet-bulb temperature is automatically estimated, and the fan is controlled so that cooling water is adjusted according to outside air temperature (humidity), resulting in reduction of wasteful power consumption.

■ Wet-bulb temperature presumption control (J198)

Set a frequency reduction value per minute in terms of wet-bulb temperature estimation.

- Data setting range: 0.01 to 120.00 (Hz/min), OFF

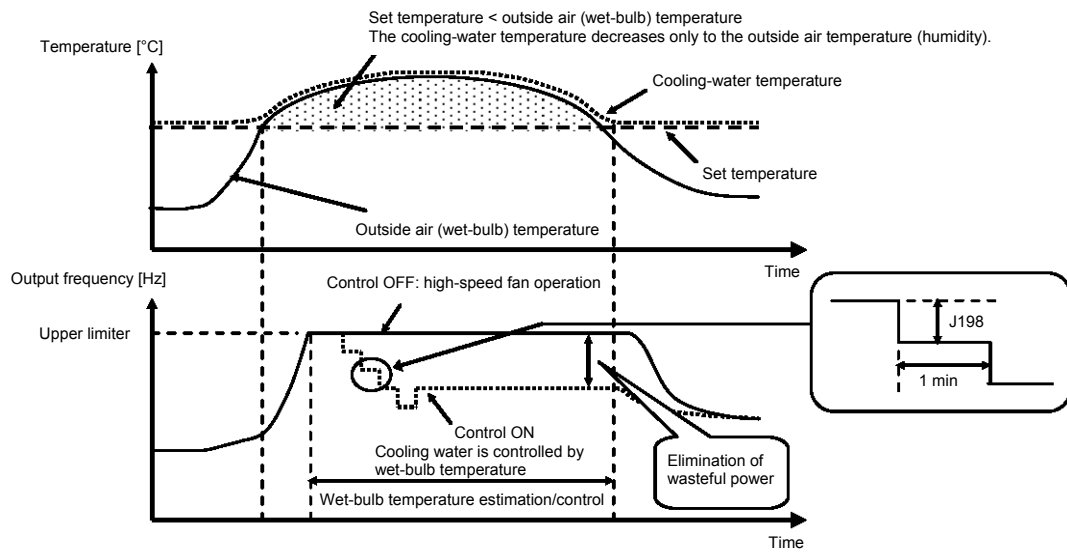

6.3.9 J2 codes (PID control 2)

J201	PID Control 2 (Mode selection)	(Refer to J101.)
-------------	---------------------------------------	-------------------------

For details about PID control 2 (mode selection) setting, refer to function code J101.

J202	PID Control 2 (Command selection)	(Refer to J102.)
-------------	--	-------------------------

For details about PID control 2 (command selection) setting, refer to function code J102.

J203	PID Control 2 (Feedback selection)	(Refer to J103.)
-------------	---	-------------------------

For details about PID control 2 (feedback selection) setting, refer to function code J103.

J205	PID Control 2 (Display unit)	(Refer to J105.)
-------------	-------------------------------------	-------------------------

For details about PID control 2 (display unit) setting, refer to function code J105.

J206 J207	PID Control 2 (Maximum scale, Minimum scale)	(Refer to J106 and J107.)
----------------------	---	----------------------------------

For details about PID control 2 (maximum scale, minimum scale) setting, refer to function codes J106 and J107.

J210	PID Control 2 P (gain)	(Refer to J110.)
J211	I (Integral time)	(Refer to J111.)
J212	D (Differential time)	(Refer to J112.)
J213	Feedback filter	(Refer to J113.)

For details about PID control 2 (P, I, D, feedback filter) setting, refer to function code J110 to J113.

J214	PID Control 2 (Anti-reset wind-up)	(Refer to J114.)
-------------	---	-------------------------

For details about PID control 2 (anti-reset wind-up) setting, refer to function code J114.

J218 J219	PID Control 2 (Upper limit of PID process output) (Lower limit of PID process output)	(Refer to J118.) (Refer to J119.)
--------------	--	--

For details about PID control 2 (upper and lower limit of PID process output) setting, refer to function codes J118 and 119.

J221 J222 J223 J224 J225	PID Control 2 (Alarm output selection) (Upper level alarm (AH)) (Upper level alarm detection hysteresis width) (Lower level alarm (AL)) (Lower level alarm detection hysteresis width)	(Refer to J121.) (Refer to J122.) (Refer to J124.)
--------------------------------------	---	---

For details about PID control 2 (alarm output selection) setting, refer to function code J121.

J227 J228 J229 J230 J231	PID Control 2 (Feedback failure detection (Mode selection)) (Feedback failure continuation duration) (Feedback failure upper-limit) (Feedback failure lower-limit) (Feedback failure detection time)	(Refer to J127.) (Refer to J128.) (Refer to J129.) (Refer to J130.) (Refer to J131.)
--------------------------------------	---	---

For details about PID control 2 (feedback failure detection) setting, refer to function code J127.

J249 J250 J251 J256 J257 J258 J259 J260	Slow Flowrate Stop Function (Mode selection) (Operation level) (Elapsed time) (Initiation inhibition time) (Cancel frequency) (Cancel deviation level 1) (Cancel delay timer) (Cancel deviation level 2)	(Refer to J149.) (Refer to J150.) (Refer to J151.) (Refer to J156.) (Refer to J157.) (Refer to J158.) (Refer to J159.) (Refer to J160.)
--	---	--

For details about the slow flowrate stop function under PID control 2, refer to the descriptions of J146 to J160.

6.3.10 J5 codes (External PID control 1)

J501	External PID Control 1 (Mode selection) J601 (External PID Control 2 (Mode selection)) J651 (External PID Control 3 (Mode selection))
-------------	--

Apart from PID control specified by J101/J210, the inverter has three channels of PID control to control external devices such as dampers and valves so that no external PID controllers are required.

Under PID control, the inverter detects the state of a control target object with a sensor or the similar device and compares it with the commanded value (e.g., temperature control command). If there is any deviation between them, PID control operates to minimize it. That is, it is a closed loop feedback system that matches controlled variable (feedback amount). PID control expands the application area of the inverter to process control (e.g., flow control, pressure control, and temperature control).

- Data setting range: 0 to 32

Data for J501/J601/J651	Function
0	Disable
1	Enable process control (Normal operation)
2	Enable process control (Inverse operation)
11	Enable process control, interlocking with inverter running (Normal operation) When the output signal RUN ("Inverter running") is ON, the process control operates.
12	Enable process control, interlocking with inverter running (Inverse operation) When the output signal RUN ("Inverter running") is ON, the process control operates.
21	Enable process control by external digital signal (Normal operation) Turning ON the terminal command "External PID control ON command" operates the process control.
22	Enable process control by external digital signal (Inverse operation) Turning ON the terminal command "External PID control ON command" operates the process control.
31	Enable process control by external digital signal, interlocking with inverter running (Normal operation) Turning ON the terminal command "External PID control ON command" when the output signal RUN ("Inverter running") is ON, the process control operates.
32	Enable process control by external digital signal, interlocking with inverter running (Inverse operation) Turning ON the terminal command "External PID control ON command" when the output signal RUN ("Inverter running") is ON, the process control operates.

To use "External PID control 1 ON command" to "External PID control 3 ON command," you need to assign the terminal command **EPID1-ON** to **EPID3-ON** to any of the general-purpose digital input terminals, respectively. (E01 to E07)

External PID control 1: "External PID control 1 ON command" **EPID1-ON** (data = 201)

External PID control 2: "External PID control 2 ON command" **EPID2-ON** (data = 211)

External PID control 3: "External PID control 3 ON command" **EPID3-ON** (data = 221)

- Note**
- If data 11, 12, 31, 32 are set, during inverter deceleration the PID control is put on hold (I item hold). PID control is put on hold only during decelerating to stop when the run command is OFF. PID control is not put on hold when decelerating to stop if the set frequency is changed.

External PID process control block diagram

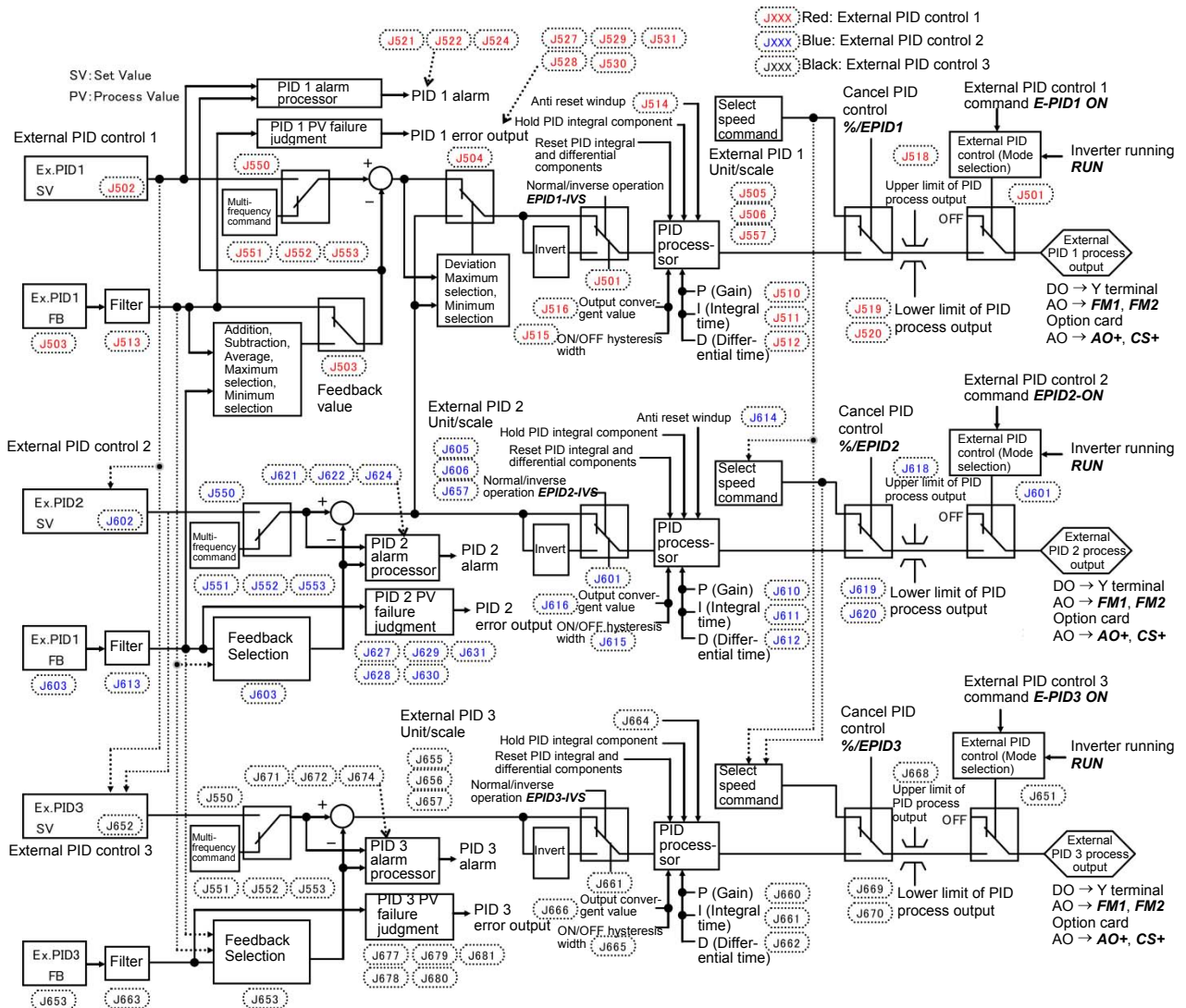

Command value (SV), Feedback value (PV)
 Analog input [12], [C1] and [V2]
 Option card [32] and [C2]

J502	External PID Control 1 (Remote command selection) J602 (External PID Control 2 (Remote command selection)) J652 (External PID Control 3 (Remote command selection))
-------------	--

J502, J602, or J652 selects the source that specifies external PID control command 1, 2 or 3, respectively. The table below lists the external PID control command sources.

- Data setting range: 0 to 112

Data for			External PID control command sources
J502	J602	J652	
0	0	0	Keypad Specify the external PID command by using the \wedge / \vee keys on the keypad.
3	3	3	Terminal command UP/DOWN With the UP and DOWN commands, 0 to 100% of an external PID control command value can be set as a value converted into physical quantity in terms of the display unit and scale.
4	4	4	Command via communications link For J502, use function code S30. The transmission data of 20000 (decimal) is equal to 100% of the PID command. For J602, use function code S31. The transmission data of 20000 (decimal) is equal to 100% of the PID command. For J652, use function code S32. The transmission data of 20000 (decimal) is equal to 100% of the PID command.
51	51	51	External PID command 1 (Analog input: Terminals [12], [C1] and [V2]) Voltage input to terminal [12] (0 to ± 10 VDC, 100% PID command/ ± 10 VDC) Current input to terminal [C1] (4 to 20 mA DC, 100% PID command/ 20 mA DC) (0 to 20 mA DC, 100% PID command/ 20 mA DC) Voltage input to the terminal [V2] (0 to ± 10 VDC, 100% PID command/ ± 10 VDC)
-	52	52	External PID command 2 (Analog input: Terminals [12], [C1] and [V2])
-	-	53	External PID command 3 (Analog input: Terminals [12], [C1] and [V2])
-	111	111	Command under external PID control 1 (J502)
-	-	112	Command under external PID control 2 (J602)

[1] External PID command with the \wedge / \vee keys on the keypad
(J502/J602/J652, data = 0 (factory default))

With the \wedge / \vee keys on the keypad, 0 to 100% of an external PID control command value can be set as a value converted into easy-to-understand, physical quantity in terms of the display unit and scale.

 For scale setting for terminals [12], [C1] or [V2], refer to function codes C59 and C60, C65 and C66, or C71 and C72, respectively.

[2] External PID command with **UP/DOWN** control (J502/J602/J652, data = 3)

When the UP/DOWN control is selected as an external PID command, turning the terminal command UP or DOWN ON causes the external PID command to change between the minimum scale and maximum scale.

External PID control 1 (J502 = 3)

The PID command can be specified in mnemonic physical quantities with the display unit (J505) and scale (J506/J507).

External PID control 2 (J602 = 3)

The PID command can be specified in mnemonic physical quantities with the display unit (J605) and scale (J606/J607).

External PID control 3 (J652 = 3)

The PID command can be specified in mnemonic physical quantities with the display unit (J655) and scale (J656/J657).

To select the **UP/DOWN** control as an external PID command, the **UP** and **DOWN** should be assigned to the digital input terminals [X1] to [X7]. (📖 E01 to E07, data = 17, 18)

UP	DOWN	Function
Data = 17	Data = 18	
OFF	OFF	Retain the current external PID command value.
ON	OFF	Increase external PID command value at a rate between 0.1%/0.1 s and 1%/0.1 s.
OFF	ON	Decrease external PID command value at a rate between 0.1%/0.1 s and 1%/0.1 s.
ON	ON	Retain the current external PID command value.

 **Note** Command settings via the UP/DOWN control are common to PID control 1, 2 (J102, J202).

[3] External PID command via communications link (J502/J602/J652, data = 4)

External PID control 1 (J502, J602, J652 = 4)

Use function code S30 that specifies the communications function code. The transmission data of 20000 (decimal) is equal to 100% of the PID command.

 For details of the communications format, refer to the RS-485 Communication User's Manual.

[4] External PID command by analog inputs (J502/J602/J652, data = 51)

When any analog input (voltage input to terminals [12] and [V2], or current input to terminal [C1]) for an external PID command is used, it is possible to arbitrary specify the PID command by multiplying the gain and adding the bias. The polarity can be selected and the filter time constant and offset can be adjusted. In addition to J502, J602 and J652 settings, it is necessary to select external PID command 1, 2 or 3 for analog input (specified by any of E61 to E63, function code data = 3). For details, refer to the descriptions of E61 to E63.

Adjustable elements of PID command

Input terminal	Input range	Bias		Gain		Polarity	Filter time constant	Offset	Input range
		Bias	Base point	Gain	Base point				
[12]	0 to +10 V, -10 to +10 V	C55	C56	C32	C34	C35	C33	C31	-
[C1]	4 to 20 mA, 0 to 20 mA	C61	C62	C37	C39	-	C38	C36	C40
[V2]	0 to +10 V, -10 to +10 V	C67	C68	C42	C44	C45	C43	C41	-

■ Offset (C31, C36, C41)

C31, C36 or C41 configures an offset for an analog voltage/current input. The offset also applies to signals sent from the external equipment.

■ Filter time constant (C33, C38, C43)

C33, C38, and C43 provide the filter time constants for the voltage and current of the analog input. Choose appropriate values for the time constants considering the response speed of the machinery system, as large time constants slow down the response. If the input voltage fluctuates because of noise, specify large time constants.

■ Polarity (C35, C45)

C35 and C45 specify the input range for analog input voltage.

Data for C35/C45	Terminal input specifications
0	-10 to +10V
1	0 to +10V (negative value of voltage is regarded as 0 V)

■ Terminal [C1] input range selection (C40)

C40 specifies the input range for terminal [C1] (analog input current).

Data for C40	Terminal input range
0	4 to 20 mA (factory default)
1	0 to 20 mA

■ Gain and bias

Terminal	Action
[12]	
[C1]	
[V2]	

(Example) Mapping the range of 1 through 5 V at terminal [12] to 0 through 100%

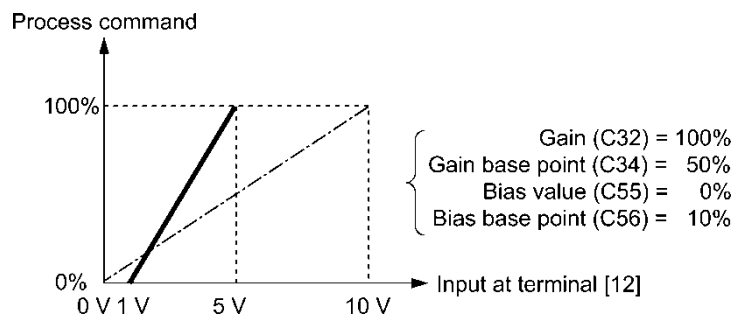

Selecting Feedback Terminals

For feedback control, determine the connection terminal according to the type of the sensor output.

- If the sensor is a current output type, use the current input terminal [C1] of the inverter.
- If the sensor is a voltage output type, use the voltage input terminal [12] of the inverter, or switch over the terminal [V2] to the voltage input terminal and use it.

For details, refer to the descriptions of E61 through E63.

Application example: Process control (for air conditioners, fans and pumps)

The operating range for PID process control is internally controlled as 0% through 100%. For the given feedback input, determine the operating range to be controlled by means of gain adjustment.

(Example) When the output level of the external sensor is within the range of 1 to 5 V:

- Use terminal [12] designed for voltage input.
- Set the gain (C32 for analog input adjustment) at 200% in order to make the maximum value (5 V) of the external sensor's output correspond to 100%. Note that the input specification for terminal [12] is 0 to 10 V corresponding to 0 to 100%; thus, a gain factor of 200% (= 10 V ÷ 5 V × 100) should be specified. Note also that any bias setting does not apply to feedback control.

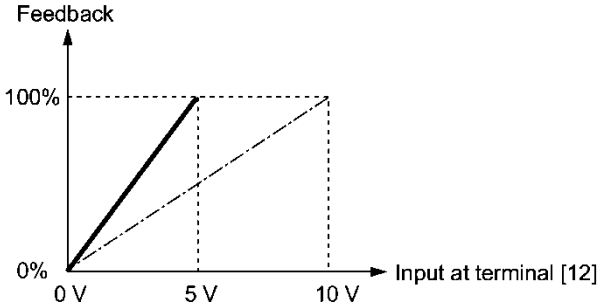

(Example 1) When the output level of the external sensor is ±7 VDC:

- Use terminal [12] since the voltage input is of bipolar.
- When the external sensor's output is of bipolar, the inverter controls the speed within the range of ±100%. To convert the output ±7 VDC to ±100%, set the gain (C32 for analog input adjustment) at 143% as calculated below.

$$\frac{10 \text{ V}}{7 \text{ V}} \approx 143\%$$

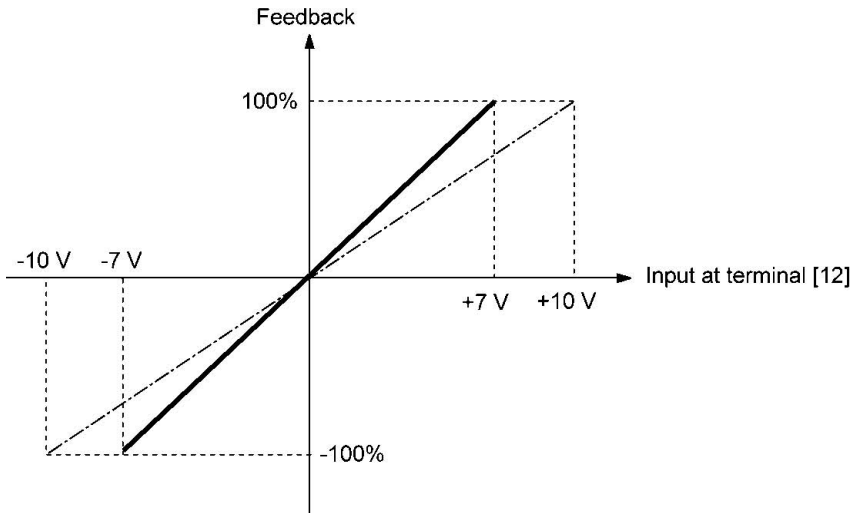

(Example 2) When the output level of the external sensor is 0 to 10 VDC:

- Use terminal [12] designed for voltage input.
- When the external sensor's output is of unipolar, the inverter controls the speed within the range of 0 to 100%.

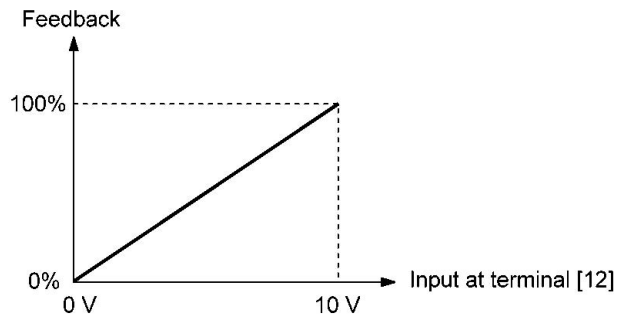

PID Display Coefficient and Monitoring

To monitor the PID command and its feedback value, set a display unit, maximum scale, and minimum scale to convert the values into easy-to-understand physical quantities (such as temperature).

- Function code of display unit, maximum scale, and minimum scale, for each terminal

	Display unit	Maximum scale	Minimum scale
Terminal [12]	C58	C59	C60
Terminal [C1]	C64	C65	C66
Terminal [V2]	C70	C71	C72

 For the monitor, refer to function code K10.

J503	External PID Control 1 (Feedback selection) J603 (External PID Control 2 (Feedback selection)) J653 (External PID Control 3 (Feedback selection))
-------------	--

J503, J603 or J653 selects a feedback value for external PID control 1, 2 or 3, respectively.
 - Data setting range: 51 to 64

J503	J603	J653	Function
51	51	51	External PID feedback value 1
-	52	52	External PID feedback value 2
-	-	53	External PID feedback value 3
60	-	-	Addition (External PID feedback value 1 + External PID feedback value 2)
61	-	-	Difference (External PID feedback value 1 - External PID feedback value 2)
62	-	-	Average (External PID feedback value 1 + External PID feedback value 2) / 2
63	-	-	Maximum (Uses the larger of external PID feedback value 1 or external PID feedback value 2)
64	-	-	Minimum (Uses the smaller of external PID feedback value 1 or external PID feedback value 2)

External PID control 1 feedback selection (J503) block diagram

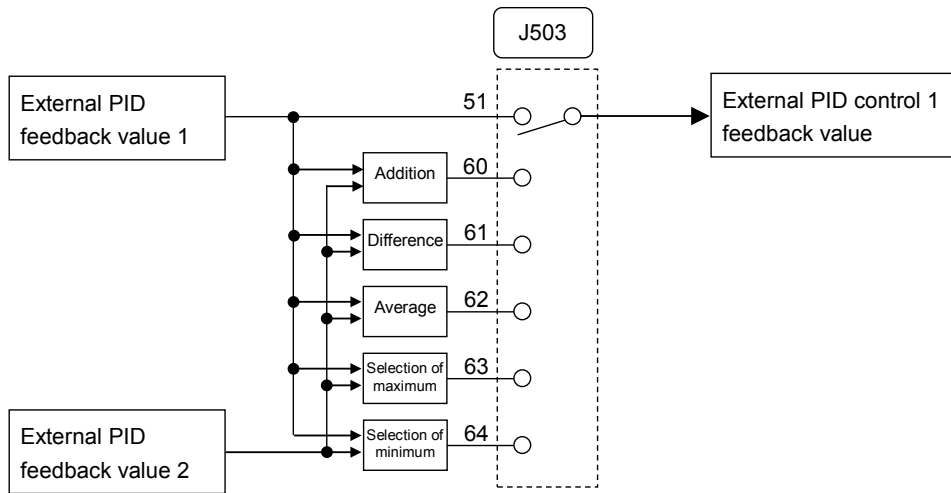

External PID control 2 feedback selection (J603) block diagram

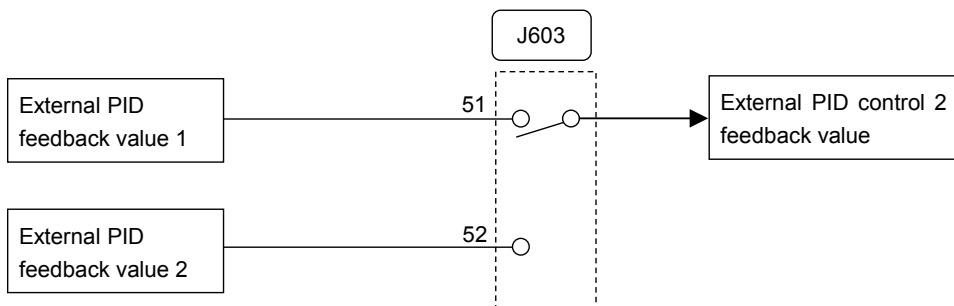

External PID control 3 feedback selection (J653) block diagram

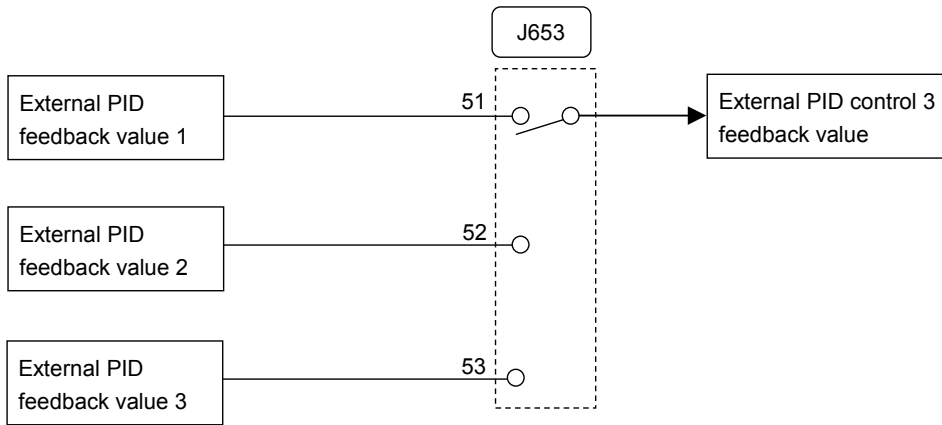

J504 External PID Control 1 (Deviation selection)

J504 selects a deviation value for external PID control 1.

- Data setting range: 0, 51, 52

Data for J504	Function
0	External PID control 1 command value (J502) - External PID control 1 feedback value (J503)
51	Selection of maximum (Uses the maximum deviation between external PID control 1 and 2)
52	Selection of minimum (Uses the minimum deviation between external PID control 1 and 2)

External PID control 1 deviation selection block diagram

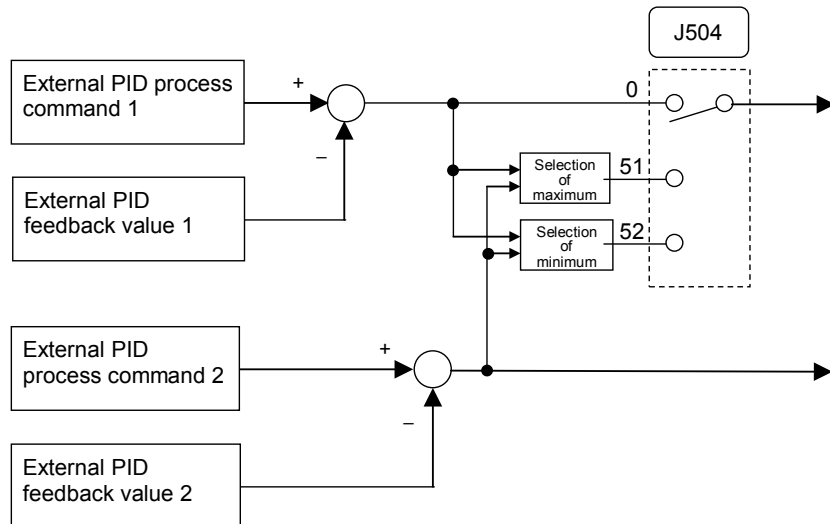

J505**External PID Control 1 (Display unit) J605 (External PID Control 2 (Display unit))
J655 (External PID Control 3 (Display unit))**

J505, J605 or J655 selects a display unit for external PID control 1, 2 or 3, respectively.

Under external PID control, the external PID command setting value (SV), feedback value (PV), manipulated value (MV) and others can be monitored on the keypad. For these values, select the display units.

For the setting procedure of the monitor display, refer to Chapter 5, Section 5.5.1 "Monitoring the running status."

 **Note** When external PID control is to be performed with the same unit and scale as for feedback values, the J505/J605/J655 settings need not be changed. (Factory default: In accordance with the unit and scale used for feedback values)

Configure the J505/J605/J655 to use different unit and scale from feedback values.

- Data setting range: 0 (Inherit) to 80

Data for J505/J605/J655	Display unit	Data for J505/J605/J655	Display unit	Data for J505/J605/J655	Display unit
0: Inherit	(Factory default)*	24	L/min (flowrate)	46	Psi (pressure)
1	No unit	25	L/h (flowrate)	47	mWG (pressure)
2	%	40	Pa (pressure)	48	inWG (pressure)
4	r/min	41	kPa (pressure)	60	K (temperature)
7	kW	42	MPa (pressure)	61	°C (temperature)
20	m ³ /s (flowrate)	43	mbar (pressure)	62	°F (temperature)
21	m ³ /min (flowrate)	44	bar (pressure)	80	ppm (density)
22	m ³ /h (flowrate)	45	mmHg (pressure)		

* In accordance with the unit and scale used for feedback values

 For feedback value selection, see function codes E61 to E63.

 The table below lists function codes to be used for setting a unit and scale for feedback values.

	Display unit	Maximum scale	Minimum scale
Terminal [12]	C58	C59	C60
Terminal [C1]	C64	C65	C66
Terminal [V2]	C70	C71	C72

J506
J507

External PID Control 1 (Maximum scale, Minimum scale)

J606, J607 (External PID Control 2 (Maximum scale, Minimum scale))

J656, J657 (External PID Control 3 (Maximum scale, Minimum scale))

J506/J507, J606/J607, or J656/J657 specify the maximum/minimum scale for external PID control 1, 2 or 3, respectively.

Set the maximum scale "External PID command value / Display value at 100% of external PID feedback value" with J506/J606/J656, and the minimum scale "External PID command value / Display value at 0% of external PID feedback value" with J507/J607/J657.

Display values are calculated with the following expression.

Display value =

$(\text{External PID control value (\%)} / 100) \times (\text{Maximum scale} - \text{Minimum scale}) + \text{Minimum scale}$

- Data setting range: (Maximum scale and minimum scale) -999.00 to 0.00 to 9990.00

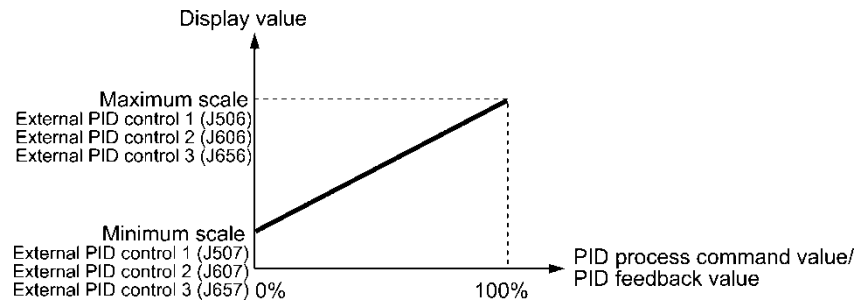

When external PID control is to be performed with the same unit and scale as for feedback values, the J506/J606/J656 or J507/J607/J657 settings need not be changed. (Factory default: In accordance with the unit and scale used for feedback values. Refer to J505/J605/J655.)

Configure the J506/J606/J656 and J507/J607/J657 to use different unit and scale from feedback values.

J510 J511 J512 J513	External PID Control 1		J515 (PID Control 1 (ON/OFF control hysteresis width))
	P (Gain)		J610 (PID Control 2 (P (Gain)))
	I (Integral time)		J611 (PID Control 2 (I (Integral time)))
	D (Differential time)		J612 (PID Control 2 (D (Differential time)))
	(Feedback filter)		J613 (PID Control 2 (Feedback filter))
			J615 (PID Control 2 (ON/OFF control hysteresis width))
	P (Gain)		J660 (PID Control 3 (P (Gain)))
	I (Integral time)		J661 (PID Control 3 (I (Integral time)))
	D (Differential time)		J662 (PID Control 3 (D (Differential time)))
	(Feedback filter)		J663 (PID Control 3 (Feedback filter))
			J665 (PID Control 3 (ON/OFF control hysteresis width))

The table below lists function codes to be used for setting the P (gain), I (integral time), D (differential time) and feedback filter for external PID controls.

	<i>P (gain)</i>	<i>I (integral time)</i>	<i>D (differential time)</i>	<i>Feedback filter</i>
<i>External PID control 1</i>	<i>J510</i>	<i>J511</i>	<i>J512</i>	<i>J513</i>
<i>External PID control 2</i>	<i>J610</i>	<i>J611</i>	<i>J612</i>	<i>J613</i>
<i>External PID control 3</i>	<i>J660</i>	<i>J661</i>	<i>J662</i>	<i>J663</i>

For details of P action, I action, D action, as well as their coordinated controls and adjusting method, see the description of J110, J111, J112, J210, J211, and J212. Note that the P (gain) of External PID (J510, J610, J660) correspond to J110 and J210. Also, I (integral time) (J511, J611, J661) correspond to J111 and J211, and the D (differential time) (J512, J612, J662) correspond to J112 and J212.

- P gain (External PID control 1: J510, External PID control 2: J610, External PID control 3: J660)

J510/J610/J660 specifies the gain for the external PID processor.

- Data setting range: 0.000 to 30.000 (times), ON/OFF

P (Proportional) action (0.000 to 30.000 times)

An operation in which the MV (manipulated value: output frequency) is proportional to the deviation is called P action, which outputs the MV in proportion to deviation. However, the P action alone cannot eliminate deviation.

Gain is data that determines the system response level against the deviation in P action. An increase in gain speeds up response, but an excessive gain may oscillate the inverter output. A decrease in gain delays response, but it stabilizes the inverter output.

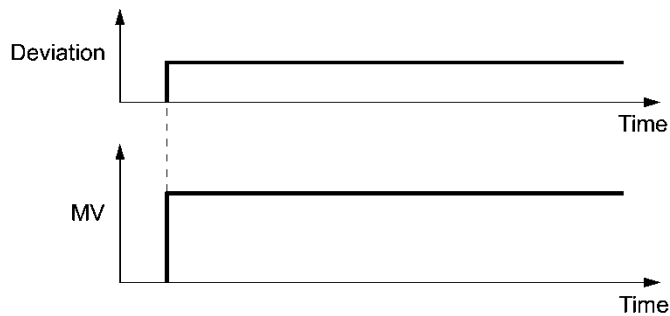

ON/OFF (ON/OFF control)

Setting the P gain (J510/J610/J660) to "OFF" enables ON/OFF control. If the feedback value (PV) exceeds the threshold value "Command setting value SV + Hysteresis width (J515)," the manipulated value (MV) switches between two positions 0% and 100%.

- Normal operation

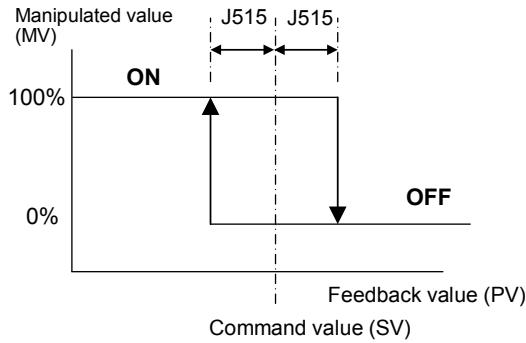

- Reverse operation

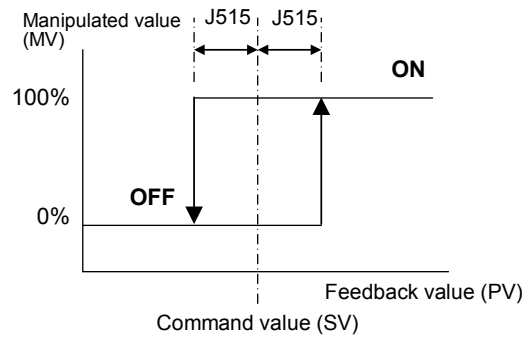

- I integral time (External PID control 1: J511, External PID control 2: J611, External PID control 3: J661)

J511/J611/J661 specifies the integral time for the external PID processor.

- Data setting range: 0.0 to 3600.0 (s)

0.0 means that the integral component is ineffective.

I (Integral) action

An operation in which the change rate of the MV (manipulated value: output frequency) is proportional to the integral value of deviation is called I action, which outputs the MV that integrates the deviation. Therefore, I action is effective in bringing the feedback amount close to the commanded value. For the system whose deviation rapidly changes, however, this action cannot make it react quickly.

The effectiveness of I action is expressed by integral time as parameter, that is J511/J611/J661 data. The longer the integral time, the slower the response. The reaction to the external disturbance also becomes slow. The shorter the integral time, the faster the response. Setting too short integral time, however, makes the inverter output tend to oscillate against the external disturbance.

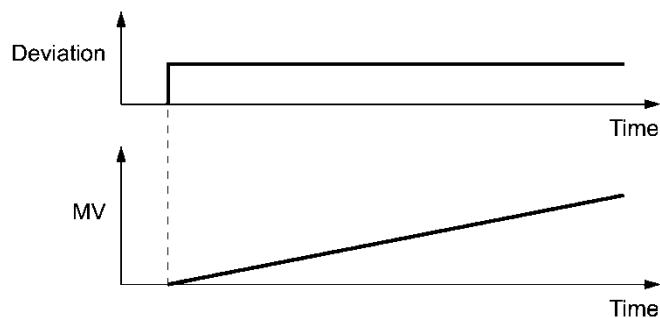

- D differential time (External PID control 1: J512, External PID control 2: J612, External PID control 3: J662)

J512/J612/J662 specifies the differential time for the external PID processor.

- Data setting range: 0.00 to 600.00 (s)
0.00 means that the differential component is ineffective.

D (Differential) action

An operation in which the MV (manipulated value: output frequency) is proportional to the differential value of the deviation is called D action, which outputs the MV that differentiates the deviation. D action makes the inverter quickly react to a rapid change of deviation.

The effectiveness of D action is expressed by differential time as a parameter. Setting a long differential time will quickly suppress oscillation caused by P action when a deviation occurs. Too long differential time makes the inverter output oscillation more. Setting short differential time weakens the suppression effect when the deviation occurs.

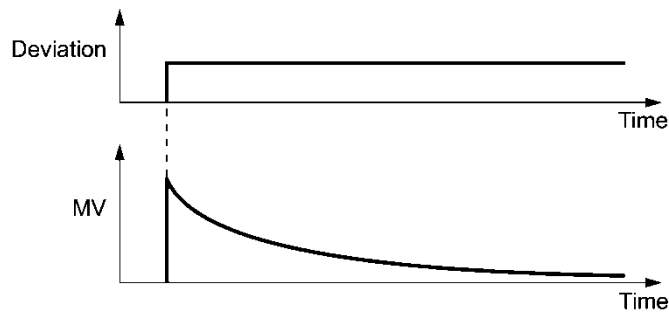

The combined uses of P, I, and D actions are described below.

(1) PI control

PI control, which is a combination of P and I actions, is generally used to minimize the remaining deviation caused by P action. PI control always acts to minimize the deviation even if a commanded value changes or external disturbance steadily occurs. However, the longer the integral time, the slower the system response to quick-changed control.

P action can be used alone for loads with very large part of integral components.

(2) PD control

Under PD control, the moment that a deviation occurs, the control rapidly generates greater MV (manipulated value) than that generated by D action alone, to suppress the deviation increase. When the deviation becomes small, the behavior of P action becomes small.

A load including the integral component in the controlled system may oscillate due to the action of the integral component if P action alone is applied. In such a case, use PD control to reduce the oscillation caused by P action, for keeping the system stable. That is, PD control is applied to a system that does not contain any damping actions in its process.

(3) PID control

PID control is implemented by combining P action with the deviation suppression of I action and the oscillation suppression of D action. PID control features minimal control deviation, high precision and high stability.

In particular, PID control is effective to a system that has a long response time to the occurrence of deviation.

Follow the procedure below to set data to external PID control function codes.

It is highly recommended that you adjust the external PID control value while monitoring the system response waveform with an oscilloscope or equivalent. Repeat the following procedure to determine the optimal solution for each system.

- Increase the data of function code J510/J610/J660 (External PID control P (Gain)) within the range where the feedback signal does not oscillate.
- Decrease the data of function code J511/J611/J661 (External PID control I (Integral time)) within the range where the feedback signal does not oscillate.
- Increase the data of J512/J612/J662 (External PID control D (Differential time)) within the range where the feedback signal does not oscillate.

Refining the system response waveforms is shown below.

1) Suppressing overshoot

Increase the data of function code J511/J611/J661 (Integral time) and decrease that of J512/J612/J662 (Differential time).

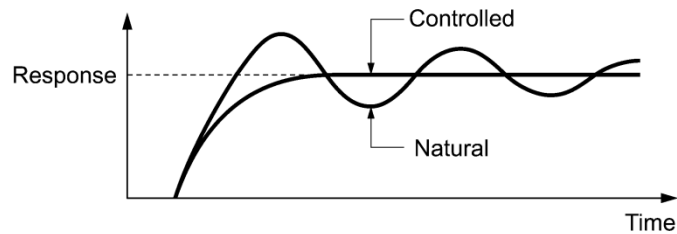

2) Quick stabilizing (moderate overshoot allowable)

Decrease the data of J510/J610/J660 (Gain) and increase that of J512/J612/J662 (Differential time).

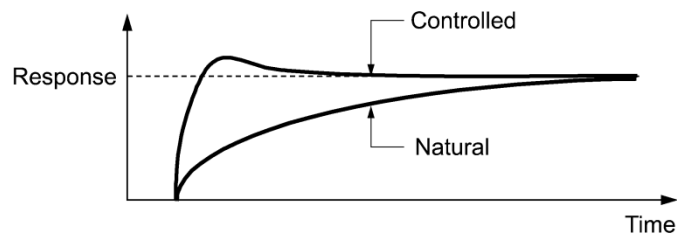

3) Suppressing oscillation whose period is longer than the integral time specified by function code J511/J611/J661

Increase the data of J511/J611/J661 (Integral time).

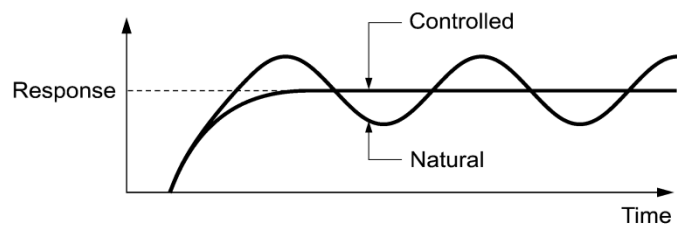

4) Suppressing oscillation whose period is approximately the same as the time specified by function code J512/J612/J662 (Differential time)

Decrease that of J512/J612/J662 (Differential time).

Decrease the data of function code J510/J610/J660 (Gain), if the oscillation cannot be suppressed even though the differential time is set at 0 sec.

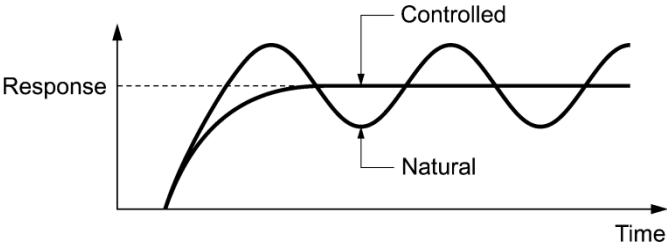

■ Feedback filter (External PID control 1: J513, External PID control 2: J613), External PID control 3: J663)

J513/J613/J663 specifies the time constant of the filter for feedback signals under the external PID control.

- Data setting range: 0.0 to 900.0 (s)
- This setting is used to stabilize the PID control loop. Setting too long a time constant makes the system response slow.

J514	External PID Control 1 (Anti-reset wind-up) J614 (External PID Control 2 (Anti-reset wind-up)) J664 (External PID Control 3 (Anti-reset wind-up))
-------------	--

J514, J614 or J664 suppresses overshoot under external PID control 1, 2 or 3 using an external PID processor, respectively. As long as the deviation between the PID command and its feedback is out of the preset range, the integrator holds its value and does not perform integration operation.

- Data setting range: OFF, 0.01 to 9990.00 (The setting range is restricted by the maximum scale and minimum scale.)

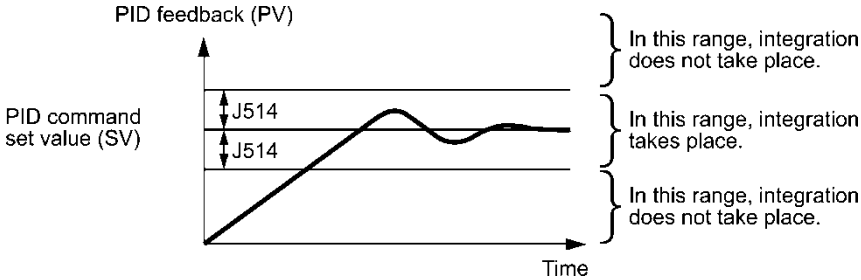

J515

External PID Control 1 (ON/OFF control hysteresis width)

J615 (External PID Control 2 (ON/OFF hysteresis width))

J665 (External PID Control 3 (ON/OFF hysteresis width))

J515, J615 or J665 specifies the hysteresis width for ON/OFF control under external PID control 1, 2 or 3 in a physical quantity, respectively.

Setting the P gain (J510/J610/J660) to "OFF" enables ON/OFF control. If the feedback value (PV) exceeds the threshold value "Command setting value SV + Hysteresis width (J515)," the manipulated value (MV) switches between two positions 0% and 100%.

- Data setting range: 0.00 to 9990.00 (The setting range is restricted by the maximum scale and minimum scale.)

• Normal operation

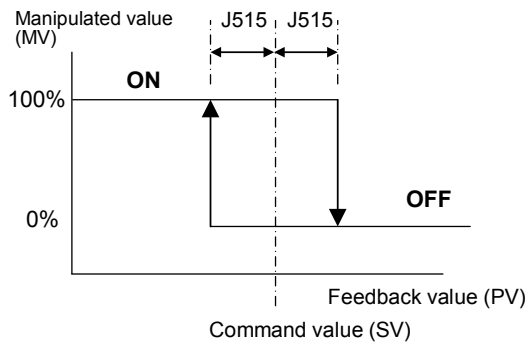

• Reverse operation

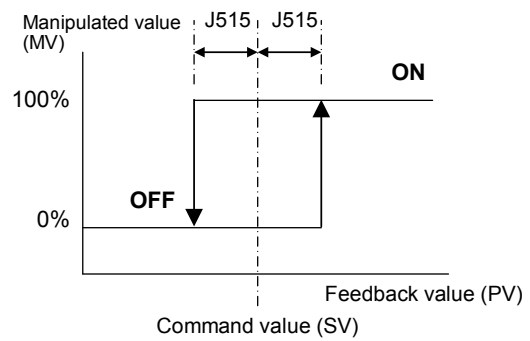

J516	External PID Control 1 (Proportional operation output convergent value) J616 (External PID Control 2 (Proportional operation output convergent value)) J666 (External PID Control 3 (Proportional operation output convergent value))
-------------	--

Exclusively for external PID control, this setting value can be added to the external PID output. J516/J616/J666 sets external PID controls 1/2/3 respectively.
 - Data setting range: 1 to 150 (%)

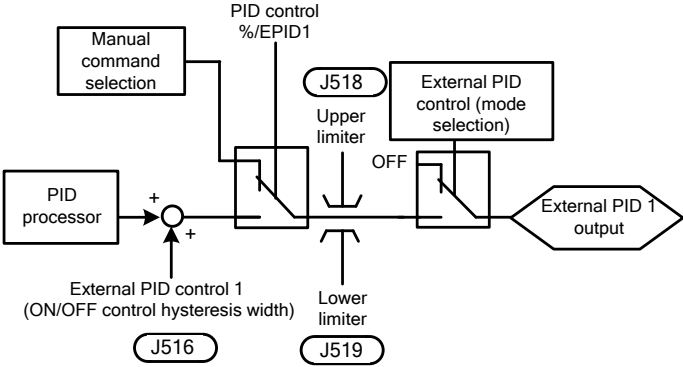

Also, by disabling I (integral time) and D (differential time) to enable only P (gain) and this value, the following comparison is possible.

• Normal operation

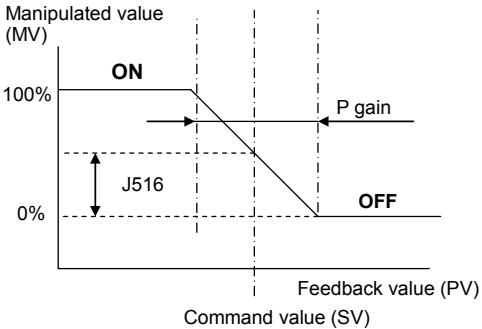

• Reverse operation

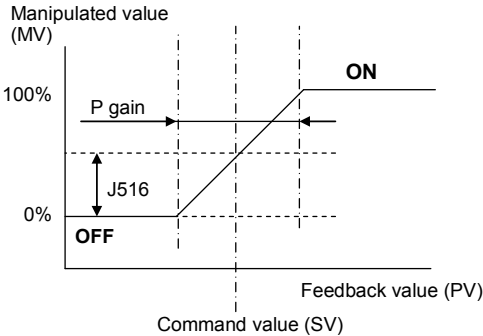

J517

External PID Control 1 (Proportional cycle)

J617 (External PID Control 2 (Proportional cycle))

J667 (External PID Control 3 (Proportional cycle))

J517, J617 or J667 specifies the output cycle (Tc) of pulse outputs under output duty control for external PID control 1, 2 or 3, respectively.

- Data setting range: 1 to 150 (s)

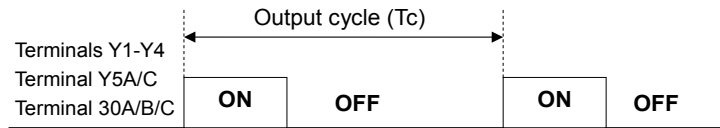

The ON and OFF times are calculated by the following expressions.

ON time = Output cycle (Tc) x Manipulated value (MV) / 100

OFF time = Output cycle (Tc) - ON time

(Example) If output cycle (Tc) = 60 s, MV = 35%

ON time = 60 s x 35% / 100 = 21 s

OFF time = 60 s - 21 s = 39 s

To use the proportional cycle, it is necessary to assign **EPID1-OUT**, **EPID2-OUT** or **EPID3-OUT** to any of digital output terminals as duty control output with any of E20 to E24 and E27.

- External PID control 1: **EPID1-OUT** (E20 to E24 and E27, data = 212)
- External PID control 2: **EPID2-OUT** (E20 to E24 and E27, data = 222)
- External PID control 3: **EPID3-OUT** (E20 to E24 and E27, data = 232)

J518 J519 J520	External PID Control 1 (Upper limit of PID process output) (Lower limit of PID process output) (Upper and lower limits) J618 (External PID Control 2 (Upper limit of PID process output)) J619 (External PID Control 2 (Upper limit of PID process output)) J620 (External PID Control 2 (Upper and lower limits)) J668 (External PID Control 3 (Upper limit of PID process output)) J669 (External PID Control 3 (Upper limit of PID process output)) J670 (External PID Control 3 (Upper and lower limits))
---	--

J518/J519/J520, J618/J619/J620 or J668/J669/J670 define the upper and lower limiters for the external PID output, which exclusively apply to external PID control 1, 2 or 3, respectively.

When external PID control is canceled with `%/EPID1`, `%/EPID2` or `%/EPID3` and manual command is used to operate, the upper and lower limiters are effective.

 E01 to E07, data = 202 (`%/EPID1`), 212 (`%/EPID2`), 222 (`%/EPID3`)

■ PID Control 1 to 3 (Upper limit of PID process output) (J518, J618, J668)

- Data setting range: -10 to 110 (%)

J518/J618/J668 specifies the upper limit of the external PID processor output limiter in %.

■ PID Control 1 to 3 (Lower limit of PID process output) (J519, J619, J669)

- Data setting range: -10 to 110 (%)

J519/J619/J669 specifies the lower limit of the external PID processor output limiter in %.

■ PID Control 1 to 3 (Upper and lower limits) (J520, J620, J670)

- Data setting range: 0, 1

J520/J620/J670 specifies the upper and lower limits of the external PID processor output limiter.

Data for J520/J620/J670	PID control	PID output limiter	
		Upper limit	Lower limit
0	External PID control 1	J518	J519
	External PID control 2	J618	J619
	External PID control 3	J668	J669
1	External PID control 1	J518 data or above ⇒ 110%	Less than J519 data ⇒ -10%
	External PID control 2	J618 data or above ⇒ 110%	Less than J619 data ⇒ -10%
	External PID control 3	J668 data or above ⇒ 110%	Less than J669 data ⇒ -10%

J521 J522 J524	External PID Control 1 (Alarm output selection) (Upper level alarm (AH)) (Lower level alarm (AL)) J621 (External PID Control 2 (Alarm output selection)) J622 (External PID Control 2 (Upper level alarm (AH)) J624 (External PID Control 2 (Lower level alarm (AL)) J671 (External PID Control 3 (Alarm output selection)) J672 (External PID Control 3 (Upper level alarm (AH)) J674 (External PID Control 3 (Lower level alarm (AL))
---	--

J521/J522/J524, J621/J622/J624, J671/J672/J674 define two types of alarm signals (absolute-value and deviation alarms) that the inverter can output for external PID control 1, 2 or 3, respectively.

To use the alarm output, it is necessary to assign *EPV1-ALM*, *EPV2-ALM* or *EPV3-ALM* to any of digital output terminals as duty control output with any of E20 to E24 and E27. To generate a light alarm, the following digital output signals can be extracted without setting the light alarm selection 4 (H184). For details of light alarms, see the description of function codes H181 to H184.

- External PID control 1: *EPV1-ALM* (E20 to E24 and E27, data = 214)
- External PID control 2: *EPV2-ALM* (E20 to E24 and E27, data = 224)
- External PID control 3: *EPV3-ALM* (E20 to E24 and E27, data = 234)

J521/J621/J671 specifies the alarm output types. J522/J622/J672 and J524/J624/J674 specify the upper and lower limits for alarms, respectively.

■ PID control 1 to 3 (Alarm output selection) (J521, J621, J671)

J521/J621/J671 specifies one of the following alarms available.

Data for J521/J621/J671	Alarm	Description
0	Absolute-value alarm (PV)	While $PV < AL$ or $AH < PV$, <i>EPV1-ALM</i> is ON.
1	Absolute-value alarm (PV) (with Hold)	Same as above (with Hold)
2	Absolute-value alarm (PV) (with Latch)	Same as above (with Latch)
3	Absolute-value alarm (PV) (with Hold and Latch)	Same as above (with Hold and Latch)
4	Deviation alarm (PV)	While $PV < SV - AL$ or $SV + AH < PV$, <i>EPV1-ALM</i> is ON.

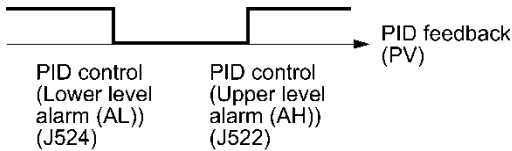
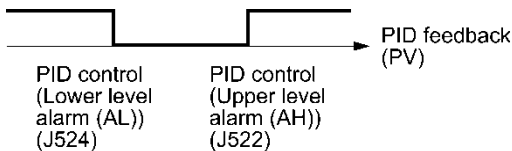
Data for J521/J621/J671	Alarm	Description
5	Deviation alarm (PV) (with Hold)	Same as above (with Hold)
6	Deviation alarm (PV) (with Latch)	Same as above (with Latch)
7	Deviation alarm (PV) (with Hold and Latch)	Same as above (with Hold and Latch)
8	Absolute-value alarm (SV)	While $SV < AL$ or $AH < SV$, <i>EPVI-ALM</i> is ON. 
9	Absolute-value alarm (SV) (with Hold)	Same as above (with Hold)
10	Absolute-value alarm (SV) (with Latch)	Same as above (with Latch)
11	Absolute-value alarm (SV) (with Hold and Latch)	Same as above (with Hold and Latch)
12	Absolute-value alarm (MV)	While $MV < AL$ or $AH < MV$, <i>EPVI-ALM</i> is ON. 
13	Absolute-value alarm (MV) (with Hold)	Same as above (with Hold)
14	Absolute-value alarm (MV) (with Latch)	Same as above (with Latch)
15	Absolute-value alarm (MV) (with Hold and Latch)	Same as above (with Hold and Latch)

SV: Process command value, PV: Feedback value, MV: Manipulated value

Hold: During the power-on sequence, the alarm output is kept OFF (disabled) even when the monitored quantity is within the alarm range. Once it goes out of the alarm range, and comes into the alarm range again, the alarm is enabled.

Latch: Once the monitored quantity comes into the alarm range and the alarm is turned ON, the alarm will remain ON even if it goes out of the alarm range. To release the latch, perform a reset by using the  key or turning the terminal command **RST** ON. Resetting can be done by the same way as resetting an alarm.

■ External PID control 1 (Upper level alarm (AH) (J522, J622, J672)

J522/J622/J672 specifies the upper limit (AH) for alarms in a physical quantity.

- Data setting range: OFF, -999.00 to 0.00 to 9990.00

The physical quantity is dependent on the display unit and maximum/minimum scale specified by the following function codes.

	<i>Display unit</i>	<i>Maximum scale</i>	<i>Minimum scale</i>
<i>External PID control 1</i>	<i>J505</i>	<i>J506</i>	<i>J507</i>
<i>External PID control 2</i>	<i>J605</i>	<i>J606</i>	<i>J607</i>
<i>External PID control 3</i>	<i>J655</i>	<i>J656</i>	<i>J657</i>

■ External PID control 1 (Lower level alarm (AL) (J524, J624, J674)

J524/J624/J674 specifies the lower limit (AL) for alarms in a physical quantity. The physical quantity is dependent on the display unit and maximum/minimum scale specified by the function codes listed above.

- Data setting range: OFF, -999.00 to 0.00 to 9990.00

Upper level alarm (AH) and lower level alarm (AL) also apply to the following alarms.

Alarm	Description	How to handle the alarm:	
		Select alarm output (J521/J621/J671)	Parameter setting
Upper limit (absolute)	ON when $AH < PV$ ON when $AH < SV$ ON when $AH < MV$	Absolute-value alarm	AL = 0
Lower limit (absolute)	ON when $PV < AL$ ON when $SV < AL$ ON when $MV < AL$		AH = 100%
Upper limit (deviation)	ON when $SV + AH < PV$	Deviation alarm	AL = 100%
Lower limit (deviation)	ON when $PV < SV - AL$		AH = 100%
Upper/lower limit (deviation)	ON when $ SV - PV > AL$		AL = AH
Upper/lower range limit (deviation)	ON when $SV - AL < PV < SV + AL$	Deviation alarm	A negative logic signal should be assigned to EPV1-ALM , EPV2-ALM , or EPV3-ALM
Upper/lower range limit (absolute)	ON when $AL < PV < AH$ ON when $AL < SV < AH$ ON when $AL < MV < AH$	Absolute-value alarm	
Upper/lower range limit (deviation)	ON when $SV - AL < PV < SV + AH$	Deviation alarm	

J527 J529 J530 J531	External PID Control 1 (Feedback error detection mode) (Feedback error upper-limit) (Feedback error lower-limit) (Feedback error detection time) J627 (External PID Control 2 (Feedback error detection mode) J629 (External PID Control 2 (Feedback error upper-limit) J630 (External PID Control 2 (Feedback error lower-limit) J631 (External PID Control 2 (Feedback error detection time) J677 (External PID Control 3 (Feedback error detection mode) J679 (External PID Control 3 (Feedback error upper-limit) J680 (External PID Control 3 (Feedback error lower-limit) J681 (External PID Control 3 (Feedback error detection time)
--	---

Under external PID control, the inverter can detect abnormal feedback values (PV).

In the case of external PID control 1, if the error level of a PV signal (Upper limit: J529, Lower limit: J53) is kept for the feedback error detection time (J531), the inverter regards it as an error, then stops or continues running according to the mode specified by J527.

The table below lists the function codes available for external PID control 1, 2 and 3.

	<i>Feedback error detection mode</i>	<i>Feedback error upper limit</i>	<i>Feedback error lower limit</i>	<i>Error detection time</i>
<i>External PID control 1</i>	<i>J527</i>	<i>J529</i>	<i>J530</i>	<i>J531</i>
<i>External PID control 2</i>	<i>J627</i>	<i>J629</i>	<i>J630</i>	<i>J631</i>
<i>External PID control 3</i>	<i>J677</i>	<i>J679</i>	<i>J680</i>	<i>J681</i>

■ External PID control 1 to 3 (Feedback error detection mode) (J527, J627, J677)

J527/J627/J677 specifies the error processing to be performed if a feedback error occurs.

- Data setting range: 0 to 2

Data for J527/J627/J677	Error processing
0	Disable: Turn ON the following output signal and continue to run. EPV1-OFF for external PID control 1 EPV2-OFF for external PID control 2 EPV3-OFF for external PID control 3
1	Enable: Coast to a stop (PVA trip)
2	Enable: Decelerate to a stop and cause a PVA trip.

Feedback errors can be monitored from the external equipment by assigning the digital output signal **EPV1-OFF**, **EPV2-OFF** or **EPV3-OFF** to any of the output terminals [Y1] to [Y4], [Y5A/C], and [30A/B/C] with any of E20 through E24 and E27.

- External PID control 1: **EPV1-OFF** (E20 to E24 and E27, data = 215)
- External PID control 2: **EPV2-OFF** (E20 to E24 and E27, data = 225)
- External PID control 3: **EPV3-OFF** (E20 to E24 and E27, data = 235)

- External PID control 1 to 3 (Feedback error lower-limit) (J529, J629, J679)
J529/J629/J679 specifies the upper limit for feedback errors in a physical quantity.
- Data setting range: -999.00 to 0.00 to 999.00, Auto = 105%

The physical quantity is dependent on the display unit and maximum/minimum scale specified by the following function codes.

	Display unit	Maximum scale	Minimum scale
External PID control 1	J505	J506	J507
External PID control 2	J605	J606	J607
External PID control 3	J655	J656	J657

- External PID control 1 to 3 (Feedback error lower-limit) (J530, J630, J680)
J530/J630/J680 specifies the lower limit for feedback errors in a physical quantity. The physical quantity is dependent on the display unit and maximum/minimum scale specified by the function codes listed above.
- Data setting range: -999.00 to 0.00 to 999.00, Auto = -5%

- External PID control 1 to 3 (Feedback error detection time) (J531, J631, J681)
J531/J631/J681 specifies the feedback error detection time for the upper-limit (J529/J629/J679) and lower-limit (J530/J630/J680). If the detection time has elapsed after a feedback error occurred, the inverter regards it as an error.
- Data setting range: 0 to 300.0 (s)

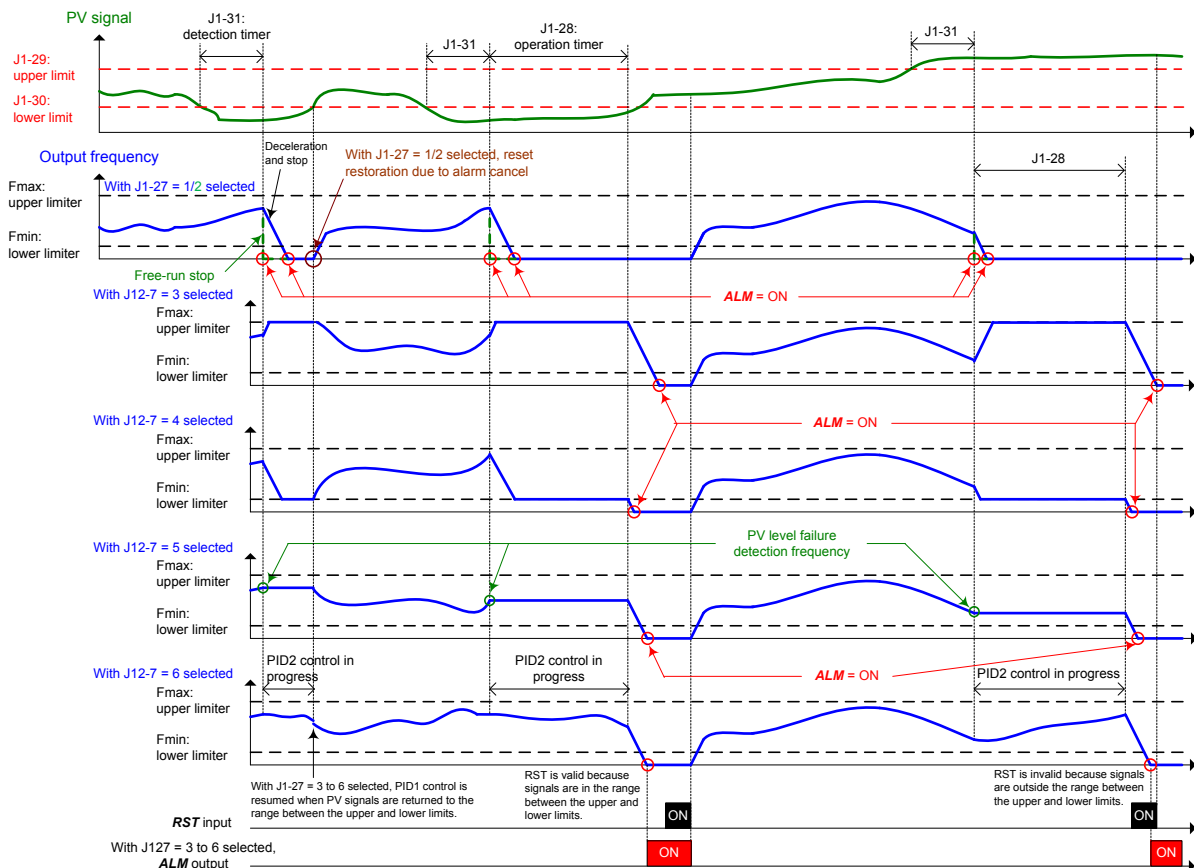

J540	External PID Control 1 (Manual command) J640 (External PID Control 2 (Manual command)) J690 (External PID Control 3 (Manual command))
-------------	--

■ External PID control 1 to 3 (Manual command) (J540, J640, J690)

J540/J640/J690 specifies the source that specifies a manual command to apply when external PID command is canceled.

- Data setting range: 0, 8, 51, 52, 53, 111, 112

<i>Data for J540/J640/J690</i>	<i>J540</i>	<i>J640</i>	<i>J690</i>	<i>Manual command sources</i>
0	✓	✓	✓	Keypad Specify the external PID command by using the \wedge / \vee keys on the keypad.
8	✓	✓	✓	Keypad (Balanceless-bumpless) Specify the external PID command by using the \wedge / \vee keys on the keypad.
51	✓	✓	✓	External PID command 1 (Analog input: Terminals [12], [C1] and [V2]) Function codes E61 to E63 (terminal [12], [C1], [V2] Extended function selection): Data = 43 Voltage input to terminal [12] (0 to ± 10 VDC, 100% PID command/ ± 10 VDC) Current input to terminal [C1] (4 to 20 mA DC, 100% PID command/ 20 mA DC) (0 to 20 mA DC, 100% PID command/ 20 mA DC) Voltage input to the terminal [V2] (0 to ± 10 VDC, 100% PID command/ ± 10 VDC)
52	-	✓	✓	External PID command 2 (Analog input: Terminals [12], [C1] and [V2]) Function codes E61 to E63 (terminal [12], [C1], [V2] Extended function selection): Data = 43
53	-	-	✓	External PID command 3 (Analog input: Terminals [12], [C1] and [V2]) Function codes E61 to E63 (terminal [12], [C1], [V2] Extended function selection): Data = 43
111	-	✓	✓	External PID control 1's manual command value Uses the manual command value (data: 0, 8, 51) specified by function code J540
112	-	-	✓	External PID control 2's manual command value Uses the manual command value (data: 0, 8, 51, 52, 111) specified by function code J640

 To cancel external PID controls, assign digital input signals `%/EPID1`, `%/EPID2`, and `%/EPID3` to digital input terminals with E01 to E07 (data = 202, 212, 222) beforehand.

J550 J551 J552 J553	External PID Multistep Command (Mode selection) (Multistep command 1) (Multistep command 2) (Multistep command 3)
--	--

J550, J551, J552 and J553 define an external PID control command as a preset value (3 steps).

■ External PID multistep command (Mode selection) (J550)

J550 selects an external PID control under which an external PID multistep command takes effect.

- Data setting range: 0 bit, 1 bit, 2 bits

<i>Data for J550</i>	<i>Function</i>
<i>0-2 bit = 0</i>	<i>Disable multistep command</i>
<i>0 bit = 1</i>	<i>Enable multistep command under external PID control 1</i>
<i>1 bit = 1</i>	<i>Enable multistep command under external PID control 2</i>
<i>2 bits = 1</i>	<i>Enable multistep command under external PID control 3</i>

■ External PID multistep command (Multistep command 1 to 3) (J551, J552, J553)

J551/J552/J553 specifies a multistep command in a physical quantity.

- Data setting range: -999.00 to 0.00 to 9990.00

• External PID command

<i>EPID-SS2</i>	<i>EPID-SS1</i>	Command
OFF	OFF	Command by J550
OFF	ON	J551 (Multistep 1)
ON	OFF	J552 (Multistep 2)
ON	ON	J553 (Multistep 3)

The physical quantity is dependent on the display unit and maximum/minimum scale specified by the following function codes.

	<i>Display unit</i>	<i>Maximum scale</i>	<i>Minimum scale</i>
<i>External PID control 1</i>	<i>J505</i>	<i>J506</i>	<i>J507</i>
<i>External PID control 2</i>	<i>J605</i>	<i>J606</i>	<i>J607</i>
<i>External PID control 3</i>	<i>J655</i>	<i>J656</i>	<i>J657</i>

Note: Factory default value is set at J505, J605, J655=0 (according to the PID control 1 feedback value unit/scale).

6.3.11 J6 codes (External PID control 2, 3)

J601	External PID Control 2 (Mode selection)	(Refer to J501.)
-------------	--	-------------------------

For details of External PID Control 2 (Mode selection), refer to the description of J501.

J602	External PID Control 2 (Remote command selection)	(Refer to J502.)
-------------	--	-------------------------

For details of External PID Control 2 (Remote command selection), refer to the description of J502.

J603	External PID Control 2 (Feedback selection)	(Refer to J503.)
-------------	--	-------------------------

For details of External PID Control 2 (Feedback selection), refer to the description of J503.

J605	External PID Control 2 (Display unit)	(Refer to J505.)
-------------	--	-------------------------

For details of External PID Control 2 (Display unit), refer to the description of J505.

J606, J607	External PID Control 2 (Maximum scale, Minimum scale)	(Refer to J506, J507.)
-------------------	--	-------------------------------

For details of External PID Control 2 (Maximum scale, Minimum scale), refer to the description of J506 to J507.

J610	External PID Control 2 P (Gain)	(Refer to J510.)
J611	I (Integral time)	(Refer to J511.)
J612	D (Differential time)	(Refer to J512.)
J613	Feedback filter	(Refer to J513.)

For details of External PID Control 2 (P (Gain), I (Integral time), D (Differential time), Feedback filter), refer to the description of J510 to J513.

J614	External PID Control 2 (Anti-reset wind-up)	(Refer to J514.)
-------------	--	-------------------------

For details of External PID Control 2 (Anti-reset wind-up), refer to the description of J514.

J615	External PID Control 2 (ON/OFF control hysteresis width)	(Refer to J515.)
-------------	---	-------------------------

For details of External PID Control 2 (ON/OFF control hysteresis width), refer to the description of J515.

J616	External PID Control 2 (Proportional operation output convergent value) (Refer to J516.)
-------------	--

For details of External PID Control 2 (Proportional operation output convergent value), refer to the description of J516.

J617	External PID Control 2 (Proportion cycle) (Refer to J517.)
-------------	--

For details of External PID Control 2 (Proportion cycle), refer to the description of J517.

J618 J619 J620	External PID Control 2 (Upper limit of PID process output) (Lower limit of PID process output) (Upper and lower limits)	(Refer to J518.) (Refer to J519.) (Refer to J520.)
---	--	---

For details of External PID Control 2 (Upper limit of PID process output, Lower limit of PID process output, Upper and lower limits), refer to the description of J518 to J520.

J621 J622 J624	External PID Control 2 (Alarm output selection) (Upper level alarm (AH)) (Lower level alarm (AL))	(Refer to J521.) (Refer to J522.) (Refer to J524.)
---	--	---

For details of External PID Control 2 (Alarm output selection, Upper level alarm (AH), Lower level alarm (AL)), refer to the description of J521 to J524.

J627 J629 J630 J631	External PID Control 2 (Feedback error detection mode) (Feedback error upper-limit) (Feedback error lower-limit) (Feedback error detection time)	(Refer to J527.) (Refer to J529.) (Refer to J530.) (Refer to J531.)
--	---	--

For details about external PID control 2 (Feedback error detection mode, Feedback error continuation duration, Feedback error upper-limit, Feedback error lower-limit, Feedback failure detection time), refer to the descriptions of J527 to J531.

J640	External PID Control 2 (Manual command) (Refer to J540.)
-------------	--

For details of External PID Control 2 (Manual command), refer to the description of J540.

J651	External PID Control 3 (Mode selection) (Refer to J501.)
-------------	--

For details of External PID Control 3 (Mode selection), refer to the description of J501.

J652	External PID Control 3 (Remote command selection)	(Refer to J502.)
-------------	--	-------------------------

For details of External PID Control 3 (Remote command selection), refer to the description of J502.

J653	External PID Control 3 (Feedback selection)	(Refer to J503.)
-------------	--	-------------------------

For details of External PID Control 3 (Feedback selection), refer to the description of J503.

J655	External PID Control 3 (Display unit)	(Refer to J505.)
-------------	--	-------------------------

For details of External PID Control 3 (Display unit), refer to the description of J505.

J656, J657	External PID Control 3 (Maximum scale, Minimum scale)	(Refer to J506, J507.)
-------------------	--	-------------------------------

For details of External PID Control 3 (Maximum scale, Minimum scale), refer to the description of J506 to J507.

J660	External PID Control 3 P (Gain)	(Refer to J510.)
J661	I (Integral time)	(Refer to J511.)
J662	D (Differential time)	(Refer to J512.)
J663	Feedback filter	(Refer to J513.)

For details of External PID Control 3 (P (Gain), I (Integral time), D (Differential time), Feedback filter), refer to the description of J510 to J513.

J664	External PID Control 3 (Anti-reset wind-up)	(Refer to J514.)
-------------	--	-------------------------

For details of External PID Control 3 (Anti-reset wind-up), refer to the description of J514.

J665	External PID Control 3 (ON/OFF control hysteresis width)	(Refer to J515.)
-------------	---	-------------------------

For details of External PID Control 3 (ON/OFF control hysteresis width), refer to the description of J515.

J666	External PID Control 3 (Proportional operation output convergent value)	(Refer to J516.)
-------------	--	-------------------------

For details of External PID Control 3 (Proportional operation output convergent value), refer to the description of J516.

J667	External PID Control 3 (Proportion cycle)	(Refer to J517.)
-------------	--	-------------------------

For details of External PID Control 3 (Proportion cycle), refer to the description of J517.

J668 J669 J670	External PID Control 3 (Upper limit of PID process output) (Lower limit of PID process output) (Upper and lower limits)	(Refer to J518.) (Refer to J519.) (Refer to J520.)
---	--	---

For details of External PID Control 3 (Upper limit of PID process output, Lower limit of PID process output, Upper and lower limits), refer to the description of J518 to J520.

J671 J672 J674	External PID Control 3 (Alarm output selection) (Upper level alarm (AH)) (Lower level alarm (AL))	(Refer to J521.) (Refer to J522.) (Refer to J524.)
---	--	---

For details of External PID Control 3 (Alarm output selection, Upper level alarm (AH), Lower level alarm (AL)), refer to the description of J521 to J524.

J677 J679 J680 J681	External PID Control 3 (Feedback error detection mode) (Feedback error upper-limit) (Feedback error lower-limit) (Feedback error detection time)	(Refer to J527.) (Refer to J529.) (Refer to J530.) (Refer to J531.)
--	---	--

For details of External PID Control 3 (Feedback failure detection (Mode selection), Feedback error continuation duration, Feedback error upper-limit, Feedback error lower-limit, Feedback error detection time), refer to the description of J527 to J531.

J690	External PID Control 3 (Manual commands)	(Refer to J540.)
-------------	---	-------------------------

For details of External PID Control 3 (Manual command), refer to the description of J540.

6.3.12 d codes (Application functions 2)

d51, d55,
d69, d98,
d99

Reserved for particular manufacturers

Function codes d51, d55, d69, d98 and d99 appear on the monitor, but they are reserved for particular manufacturers. Unless otherwise specified, do not access these function codes.

6.3.13 U codes (Customizable logic functions)

U00
U01 to U70
U71 to U77
U81 to U87
U92 to U97

Customizable Logic (Mode selection)
Customizable Logic: Step 1 to 14 (Setting)
Customizable Logic Output Signal 1 to 7 (Output selection)
Customizable Logic Output Signal 1 to 7 (Function selection)
Customizable Logic Conversion Coefficients

The customizable logic function allows the user to form logic circuits and calculation circuits with respect to digital and analog I/O signals, process signals arbitrarily, and establish simplified relay sequences in the inverter.

In the customizable logic, the following can be specified as one step (component) to establish sequences using 14 steps in total:

- (1) Digital 2 inputs/digital 1 output + logic calculation (including timer)
- (2) Analog 2 inputs/analog 1 output/digital 1 output + value calculation
- (3) Analog 1 input/1 digital input/analog 1 output + value calculation/logic calculation

■ Specifications

Item	Specifications		
	Digital 2 inputs	Analog 2 inputs	Analog 1 input Digital 1 input
Input signal	Digital 2 inputs	Analog 2 inputs	Analog 1 input Digital 1 input
Operation block	Logical operation, counter, etc.: 13 types Timer: 5 types	23 types such as value calculation, comparator and limiter	6 types such as selector and hold limiter
Output signal	Digital 1 output	Analog 1 output/ digital 1 output	Analog 1 output
Number of steps	14 steps		
Customizable logic output signal	7 outputs		
Customizable logic processing time	5 ms		

■ Block diagram

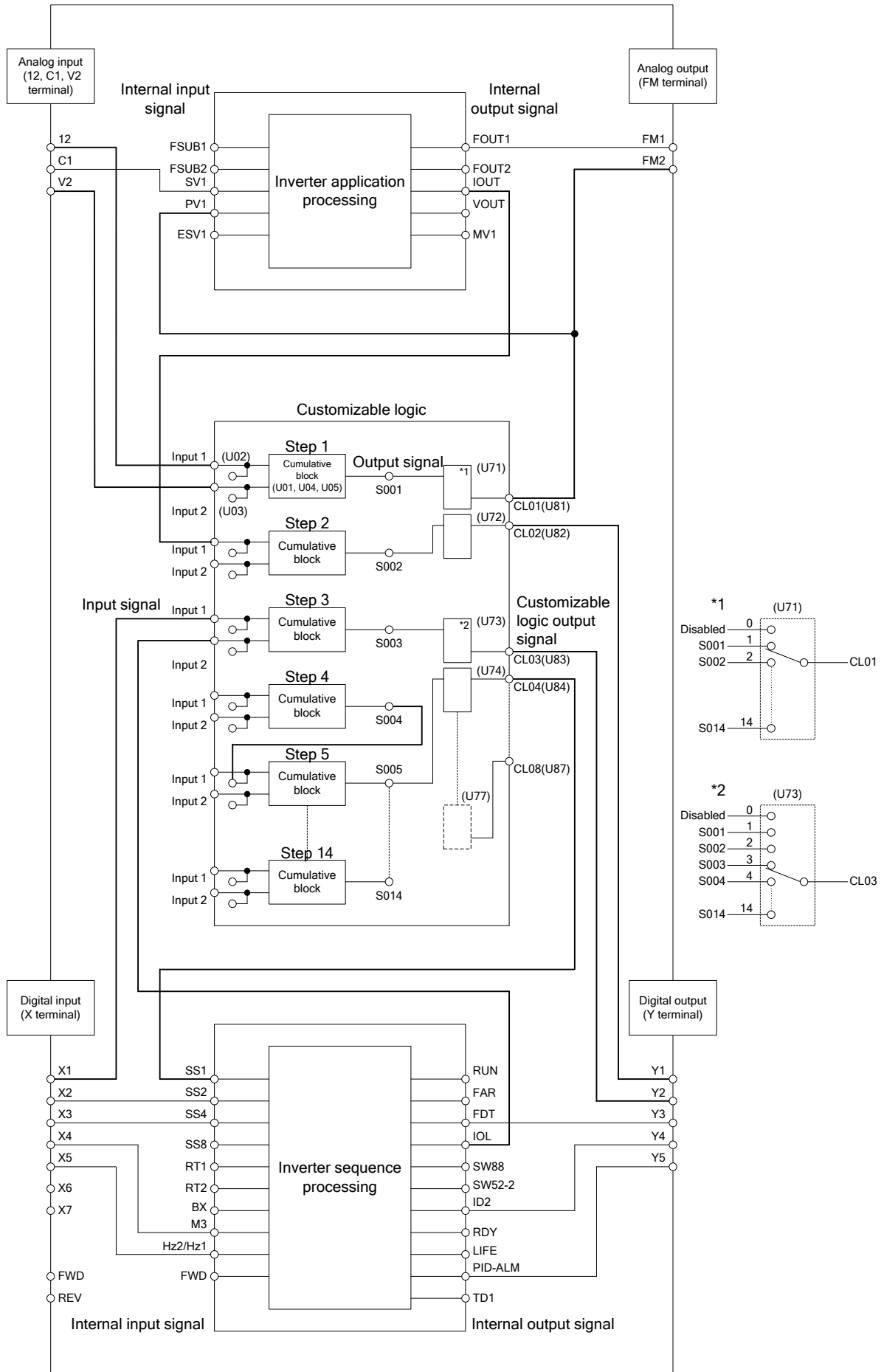

■ Customizable Logic (Mode selection) (U00)

U00 specifies whether to enable the sequence configured with the customizable logic function or disable it to run the inverter only via its input terminals and others.

Data for U00	Function
0	Disable
1	Enable (Customizable logic operation)

■ Customizable Logic (Setting) (U01 to U70)

The components in one step of the customizable logic are classified into the following three block diagrams.

[Input: Digital] U01, U06, U16, etc. = 1 to 1999

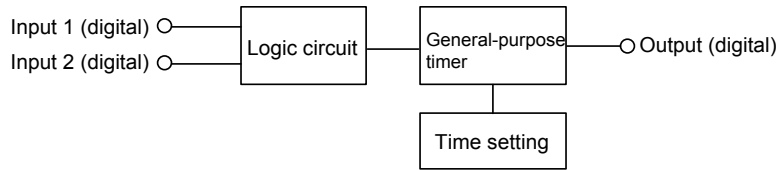

[Input: Analog] U01, U06, U16, etc. = 2001 to 3999

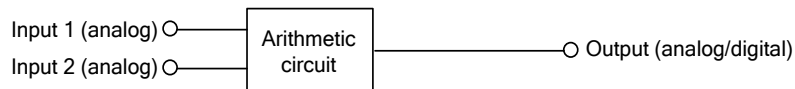

[Input: Digital, analog] U01, U06, U16, etc. = 4001 to 5999

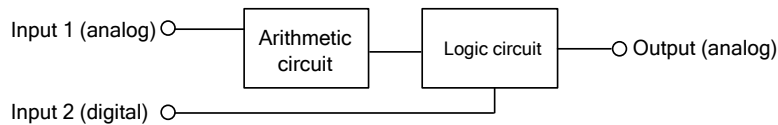

Configuration of function codes for each step

Step No.	Logic circuit	Input selection	Input selection	Function 1	Function 2	Output (Note)
Step 1	U01	U02	U03	U04	U05	SO01
	= 1 to 1999	Digital input 1	Digital input 2	Time setting	Not required	Digital output
	= 2001 to 3999	Analog input 1	Analog input 2	Value 1	Value 2	Analog/digital output
	= 4001 to 5999	Analog input 1	Digital input 2	Value 1	Value 2	Analog output
Step 2	U06	U07	U08	U09	U10	SO02
Step 3	U11	U12	U13	U14	U15	SO03
Step 4	U16	U17	U18	U19	U20	SO04
Step 5	U21	U22	U23	U24	U25	SO05
Step 6	U26	U27	U28	U29	U30	SO06
Step 7	U31	U32	U33	U34	U35	SO07
Step 8	U36	U37	U38	U39	U40	SO08
Step 9	U41	U42	U43	U44	U45	SO09
Step 10	U46	U47	U48	U49	U50	SO10
Step 11	U51	U52	U53	U54	U55	SO11
Step 12	U56	U57	U58	U59	U60	SO12
Step 13	U61	U62	U63	U64	U65	SO13
Step 14	U66	U67	U68	U69	U70	SO14

(Note) These items shown in this column are output signals, not function codes.

Setting of [Input: Digital]

■ Logic circuit (U01, etc.)

Any of the following functions is selectable as a logic circuit (with general-purpose timer).

Data	Function	Description
0	No function assigned	Output is always OFF.
10	Through output + General-purpose timer (No timer)	Only a general-purpose timer. No logic circuit exists.
11	(On-delay timer)	Turning an input signal ON starts the on-delay timer. When the period specified by the timer has elapsed, an output signal turns ON. Turning the input signal OFF turns the output signal OFF.
12	(Off-delay timer)	Turning an input signal ON turns an output signal ON. Turning the input signal OFF starts the off-delay timer. When the period specified by the timer has elapsed, the output signal turns OFF.
13	(One-shot pulse output)	Turning an input signal ON issues a one-shot pulse whose length is specified by the timer.
14	(Retriggerable timer)	Turning an input signal ON issues a one-shot pulse whose length is specified by the timer. If an input signal is turned ON again during the preceding one-shot pulse length, however, the logic circuit issues another one-shot pulse.
15	(Pulse train output)	If an input signal turns ON, the logic circuit issues ON and OFF pulses (whose lengths are specified by the timer) alternately and repeatedly. This function is used to flash a luminescent device.
20 to 25	ANDing + General-purpose timer	AND circuit with 2 inputs and 1 output, plus general-purpose timer.
30 to 35	ORing + General-purpose timer	OR circuit with 2 inputs and 1 output, plus general-purpose timer.
40 to 45	XORing + General-purpose timer	XOR circuit with 2 inputs and 1 output, plus general-purpose timer.
50 to 55	Set priority flip-flop + General-purpose timer	Set priority flip-flop with 2 inputs and 1 output, plus general-purpose timer.
60 to 65	Reset priority flip-flop + General-purpose timer	Reset priority flip-flop with 2 inputs and 1 output, plus general-purpose timer.
70, 72, 73	Rising edge detector + General-purpose timer	Rising edge detector with 1 input and 1 output, plus general-purpose timer. This detects the rising edge of an input signal and outputs the ON signal for 5 ms.
80, 82, 83	Falling edge detector + General-purpose timer	Falling edge detector with 1 input and 1 output, plus general-purpose timer. This detects the falling edge of an input signal and outputs the ON signal for 5 ms.
90, 92, 93	Rising & falling edges detector + General-purpose timer	Rising and falling edges detector with 1 input and 1 output, plus general-purpose timer. This detects both the falling and rising edges of an input signal and outputs the ON signal for 5 ms.

Data	Function	Description
100 to 105	Hold + General-purpose timer	Hold function of previous values of 2 inputs and 1 output, plus general-purpose timer. If the hold control signal is OFF, the logic circuit outputs input signals; if it is ON, the logic circuit retains the previous values of input signals.
110	Increment counter	Increment counter with reset input. By the rising edge of an input signal, the logic circuit increments the counter value by one. When the counter value reaches the target one, the output signal turns ON. Turning the reset signal ON resets the counter to zero.
120	Decrement counter	Decrement counter with reset input. By the rising edge of an input signal, the logic circuit decrements the counter value by one. When the counter value reaches zero, the output signal turns ON. Turning the reset signal ON resets the counter to the initial value.
130	Timer with reset input	Timer output with reset input. If an input signal turns ON, the output signal turns ON and the timer starts. When the period specified by the timer has elapsed, the output signal turns OFF, regardless of the input signal state. Turning the reset signal ON resets the current timer value to zero and turns the output OFF.

The block diagrams for individual functions are given below.

(data = 1□) Through output

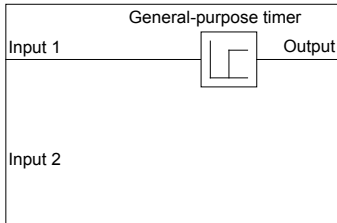

(data = 2□) AND

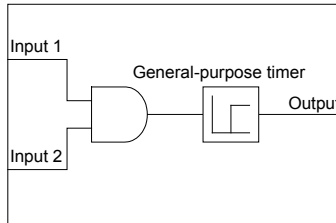

(data = 3□) OR

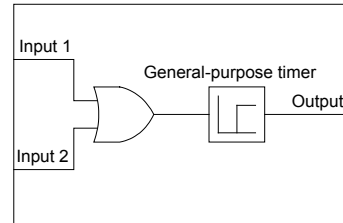

(data = 4□) XOR

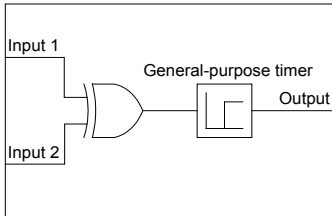

(data = 5□) Set priority flip-flop

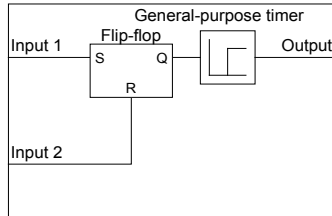

Input 1	Input 2	Previous output	Output	Remarks
OFF	OFF	OFF	OFF	Hold previous value
	ON	ON	ON	
	ON	ON	—	OFF
ON	—	—	ON	Set priority

(data = 6□) Reset priority flip-flop

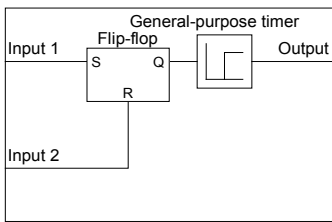

Input 1	Input 2	Previous output	Output	Remarks
OFF	OFF	OFF	OFF	Hold previous value
		ON	ON	
—	ON	—	OFF	Reset priority
ON	OFF	—	ON	

(data = 7□) Rising edge detector

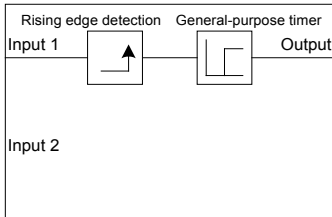

(data = 8□) Falling edge detector

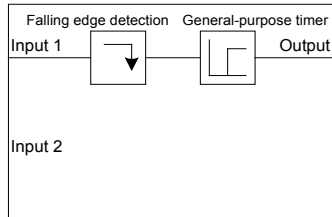

(data = 9□) Rising & falling edges detector

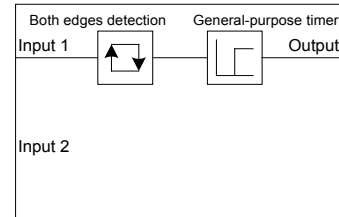

(data = 10□) Hold

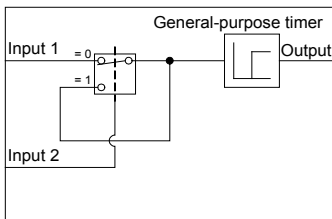

(data = 110) Increment counter

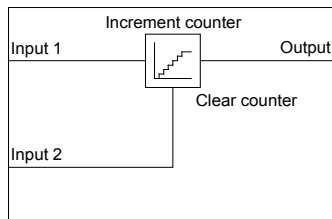

(data = 120) Decrement counter

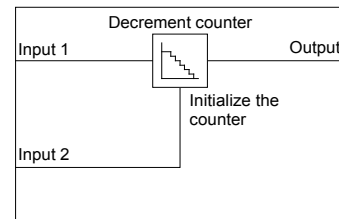

(data = 130) Timer with reset input

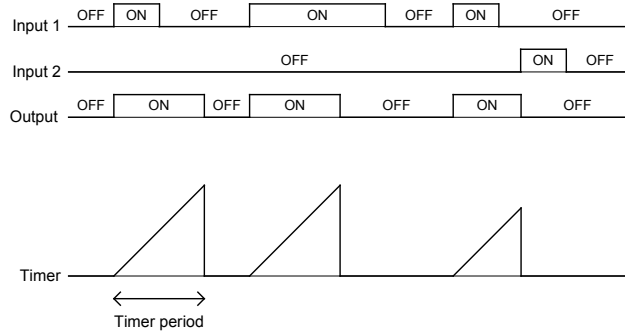
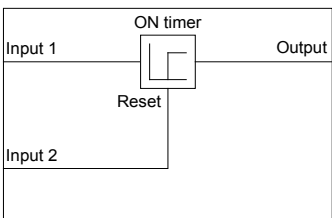

■ General-purpose timer

The operation schemes for individual timers are shown below.

(end 1) On-delay timer

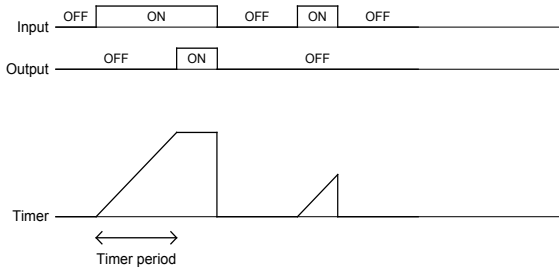

(end 2) Off-delay timer

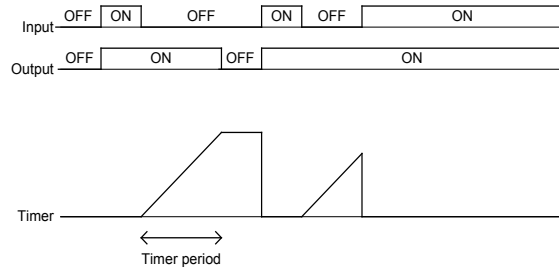

(end 3) One-shot pulse output

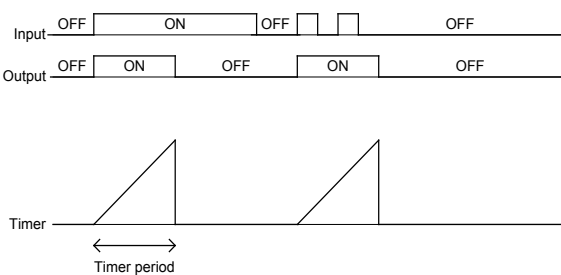

(end 4) Retriggerable timer

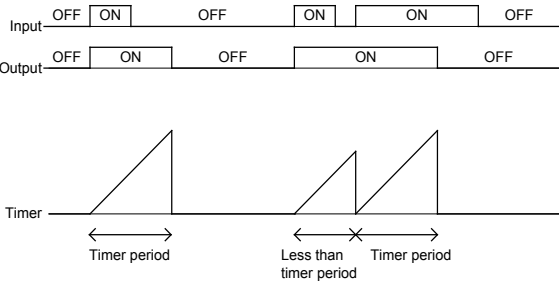

(end 5) Pulse train output

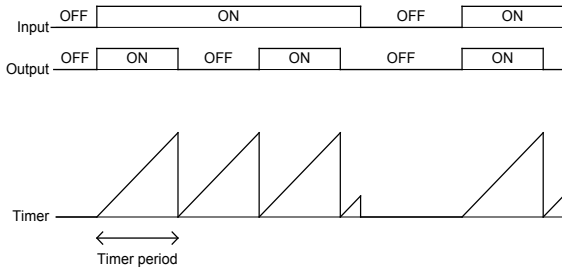

■ Digital inputs 1 and 2 (U02, U03, etc.)

The following signals are available as input signals.

Data	Selectable Signals
0000 (1000) 0235 (1235)	General-purpose output signals Same as the ones specified by E20, e.g., RUN (Inverter running), FAR (Frequency (speed) arrival signal), FDT (Frequency (speed) detected), LU (Undervoltage detected (Inverter stopped)), B/D (Torque polarity detected) Note: 27 (Universal DO) is not available. Note: 111 (1111) to 117 (1117) are not available.
2001 (3001)	Output of step 1 SO01
2002 (3002)	Output of step 2 SO02
2003 (3003)	Output of step 3 SO03
2004 (3004)	Output of step 4 SO04
2005 (3005)	Output of step 5 SO05
2006 (3006)	Output of step 6 SO06
2007 (3007)	Output of step 7 SO07

Data	Selectable Signals	
2008 (3008)	Output of step 8	SO08
2009 (3009)	Output of step 9	SO09
2010 (3010)	Output of step 10	SO10
2011 (3011)	Output of step 11	SO11
2012 (3012)	Output of step 12	SO12
2013 (3013)	Output of step 13	SO13
2014 (3014)	Output of step 14	SO14
4001 (5001)	Terminal [X1] input signal	X1
4002 (5002)	Terminal [X2] input signal	X2
4003 (5003)	Terminal [X3] input signal	X3
4004 (5004)	Terminal [X4] input signal	X4
4005 (5005)	Terminal [X5] input signal	X5
4006 (5006)	Terminal [X6] input signal	X6
4007 (5007)	Terminal [X7] input signal	X7
4010 (5010)	Terminal [FWD] input signal	FWD
4011 (5011)	Terminal [REV] input signal	REV
6000 (7000)	Final run command (ON when "frequency command ≠ 0" and a run command is given)	FL_RUN
6001 (7001)	Final FWD run command (ON when "frequency command ≠ 0" and a run forward command is given)	FL_FWD
6002 (7002)	Final REV run command (ON when "frequency command ≠ 0" and a run reverse command is given)	FL_REV
6003 (7003)	During acceleration (ON during acceleration)	DACC
6004 (7004)	During deceleration (ON during deceleration)	DDEC
6005 (7005)	Under anti-regenerative control (ON under anti-regenerative control)	REGA
6007 (7007)	Alarm factor presence (ON when there is no alarm factor)	ALM_ACT

■ Time setting (U04, etc.)

U04 and other related function codes specify the general-purpose timer period or the increment/decrement counter value.

Data	Function	Description
0.00 to +600.00	Timer period	The period is specified by seconds.
	Counter value	The specified value is multiplied by 100 times. (If 0.01 is specified, it is converted to 1.)
-9990.00 to -0.01	--	The timer period or counter value is regarded as 0.00. (No timer)
+601.00 to +9990.00	--	The timer period or counter value is regarded as 600. * It works up to 9990 at ROM version 2450 or later.

Setting of [Input: Analog]

■ Calculation circuit (U01, U04, U05, etc)

The following functions can be selected as a calculation circuit.

Furthermore, when upper and lower limit values are the same values, they operate as without upper and lower limits.

Data for U01	Function	Description	Such as U04	Such as U05
0	No function	Output is always 0% (or OFF).	No object	No object
2001	Addition	2 inputs 1 output summing circuit	Upper limit	Lower limit
2002	Subtraction	2 inputs 1 output subtraction circuit	Upper limit	Lower limit
2003	Multiplication	2 inputs 1 output multiplication circuit	Upper limit	Lower limit
2004	Division	Division circuit of 2 inputs 1 output	Upper limit	Lower limit
2005	Limiter	Upper and lower limit limiter circuit of 1 input 1 output	Upper limit	Lower limit
2006	Absolute value	Absolute value circuit of 1 input 1 output	Upper limit	Lower limit
2007	Inversion addition	Inversion circuit of 1 input 1 output	Addition value (former clause)	Addition value (latter clause)
2051	Comparison 1	Output the comparison of 2 input deviations digitally.	Deviation	Hysteresis width
2052	Comparison 2	Output the comparison of 2 input deviations digitally.	Deviation	Hysteresis width
2053	Comparison 3	Output the comparison of 2 input deviations (absolute value) digitally.	Deviation	Hysteresis width
2054	Comparison 4	Output the comparison of 2 input deviations (absolute value) digitally.	Deviation	Hysteresis width
2055	Comparison 5	Output the comparison between 1 input and 1 reference value digitally.	Reference value	Hysteresis width
2056	Comparison 6	Output the comparison between 1 input and 1 reference value digitally.	Reference value	Hysteresis width
2071	Window comparison 1	Output the comparison between 1 input and upper/lower threshold value.	Upper threshold value	Lower threshold value
2072	Window comparison 2	Output the comparison between 1 input and upper/lower threshold value.	Upper threshold value	Lower threshold value
2101	Maximum selection	Circuit to output the maximum value of 2 inputs.	Upper limit	Lower limit
2102	Minimum selection	Circuit to output the minimum value of 2 inputs.	Upper limit	Lower limit
2103	Average	Circuit to output the average of 2 inputs.	Upper limit	Lower limit
2151	Function code	The value of function code S13 (%) shall be input.	Maximum scale	Minimum scale
2201	Scale inverse transformation	Circuit to convert 1 analog input to 0-100.00 with scale set value. Use this circuit for connection to analog output terminals. Up to two steps can be used.	Maximum scale	Minimum scale
2202	Scale transformation	Circuit to convert 0-100.00 of analog 1 input with scale set value. For input 1, 8000-8085 only are available. Up to two steps can be used.	Maximum scale	Minimum scale

Data for U01	Function	Description	Such as U04	Such as U05
3001	Conversion 1	$K_A \times (\text{Input1})^2 + K_B \times \text{Input1} + K_C$ Use coefficient group (1) A single step, 3001 or 3002, can be used.	Upper limit	Lower limit
3002	Conversion 2	$\sqrt{\frac{\text{Input1} + K_A}{K_B}} \times K_C$ Use coefficient group (1) A single step, 3001 or 3002, can be used.	Upper limit	Lower limit

The block diagrams of individual functions are shown below.

(2001) Addition

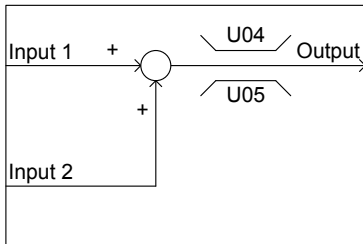

(2002) Subtraction

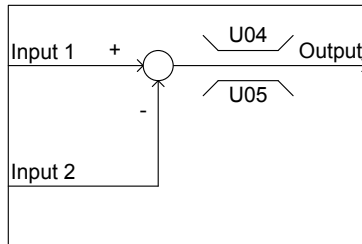

(2003) Multiplication

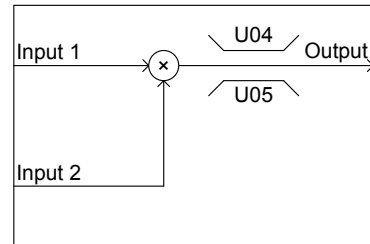

(2004) Division

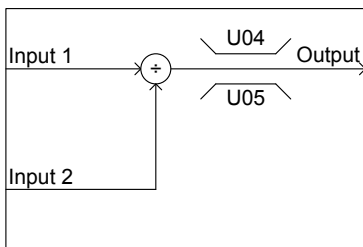

(2005) Limiter

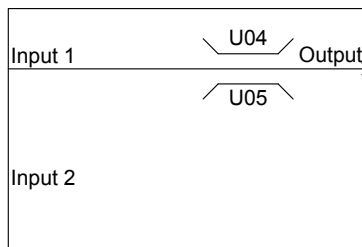

(2006) Absolute value

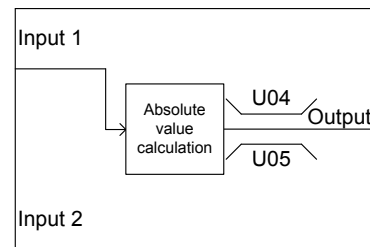

(2007) Inversion addition

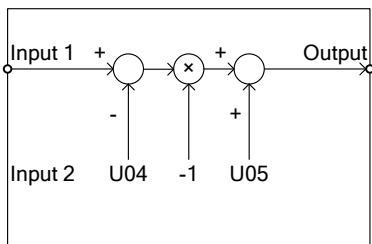

(2051) Comparison 1

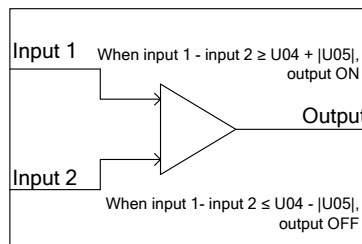

(2052) Comparison 2

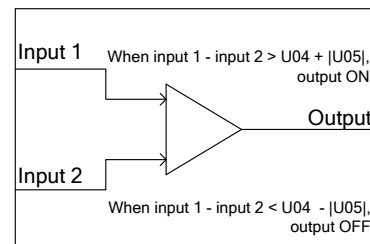

If both conditions are satisfied, "output ON" has priority.

(2053) Comparison 3

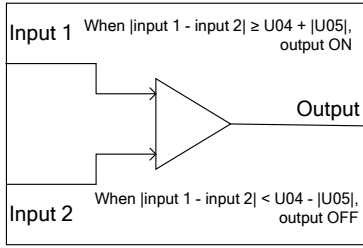

(2054) Comparison 4

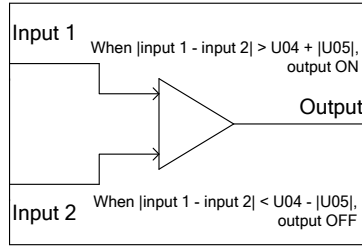

(2055) Comparison 5

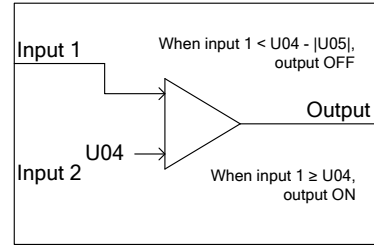

If both conditions are satisfied, "output ON" has priority

(2056) Comparison 6

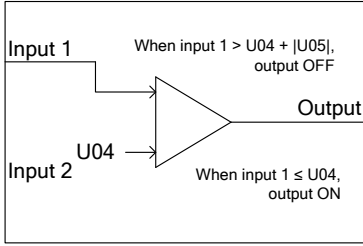

(2071) Window comparison 1

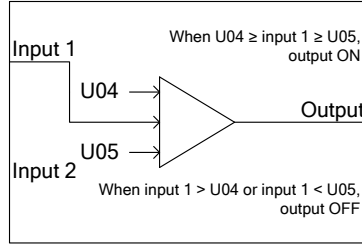

(2072) Window comparison 2

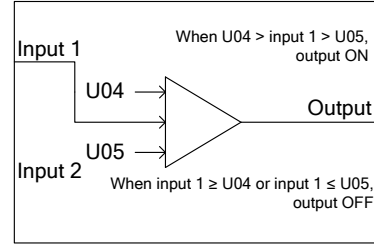

(2101) Maximum selection

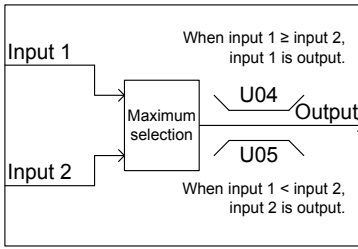

(2102) Minimum selection

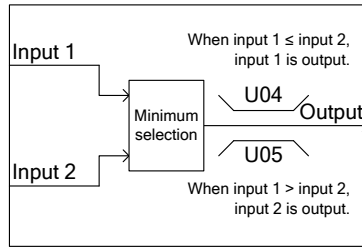

(2103) Average

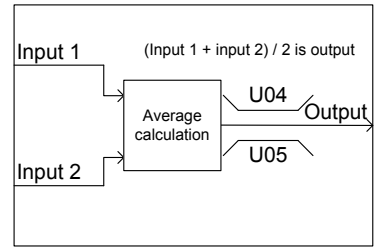

(2151) Function code input

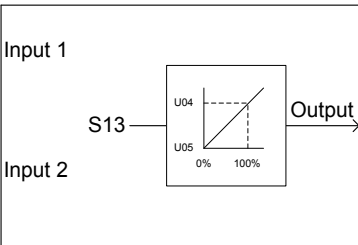

(2201) Scale inverse transformation

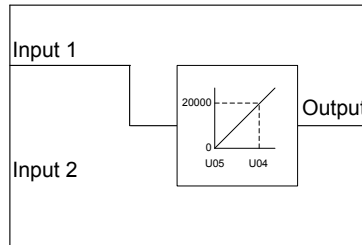

(2202) Scale transformation

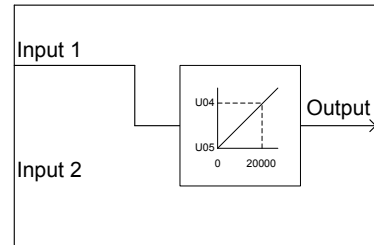

* To be used for connection to analog output terminals.
 * For input 1, 8000-8085 only are available.
 * Up to 2 steps can be used.
 * Up to 2 steps can be used.

(3001) Conversion 1

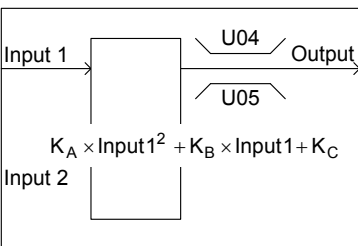

(3002) Conversion 2

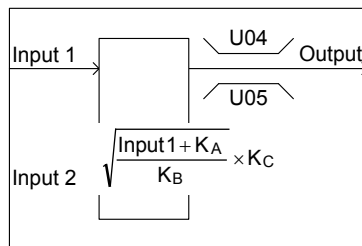

* A single step, 3001 or 3002, can be used.

■ Analog inputs 1 and 2 (U02, U03, etc.)

The following signals are available as input signals.

Data	Selectable Signals
8000 8085	Analog general-purpose output signal (same with signals selected with F31, F35: output frequency 1, output current, output torque, electric power consumption, direct-current intermediate circuit voltage, etc) Example: In the case of the maximum frequency with output frequency 1, 100.00 is input as 100%. Example: In the case of output current, 100.00 is input when the current is 200% of the inverter rated value. Note: 10 (universal AO) cannot be selected.
2001	Output of step 1 <i>SO01</i>
2002	Output of step 2 <i>SO02</i>
2003	Output of step 3 <i>SO03</i>
2004	Output of step 4 <i>SO04</i>
2005	Output of step 5 <i>SO05</i>
2006	Output of step 6 <i>SO06</i>
2007	Output of step 7 <i>SO07</i>
2008	Output of step 8 <i>SO08</i>
2009	Output of step 9 <i>SO09</i>
2010	Output of step 10 <i>SO10</i>
2011	Output of step 11 <i>SO11</i>
2012	Output of step 12 <i>SO12</i>
2013	Output of step 13 <i>SO13</i>
2014	Output of step 14 <i>SO14</i>
9001	Analog 12 terminal input signal <i>I2</i>
9002	Analog 12 terminal input signal <i>C1</i>
9003	Analog 12 terminal input signal <i>V2</i>
9004	Analog 32 terminal input signal <i>32</i>
9005	Analog C2 terminal input signal <i>C2</i>
9006	Temperature detection Pt channel 1
9007	Temperature detection Pt channel 2

■ Value setting (U04, U05, etc)

The upper and lower limits of calculation circuit are specified.

Data	Function	Description
-9990.00 to 0.00 to +9990.00	Reference value Hysteresis width Upper limit Lower limit Upper threshold value Lower threshold value Set value Maximum scale Minimum scale	Set value in accordance with the calculation circuit selected in mode setting such as U01.

■ Setting of conversion coefficient (U92 to U97)

The coefficients of calculation circuit conversion functions (3001 and 3002) are specified.

Function code	Name	Data setting range	Factory default
U92	Mantissa of calculation coefficient K_A	Mantissa: -9.999 to 9.999 Exponent: -5 to 5	0.000
U93	Exponent of calculation coefficient K_A		0
U94	Mantissa of calculation coefficient K_B		0.000
U95	Exponent of calculation coefficient K_B		0
U96	Mantissa of calculation coefficient K_C		0.000
U97	Exponent of calculation coefficient K_C		0

Setting of [Input: Digital, analog]

■ Calculation circuit/logic circuit (U01, U04, U05, etc)

The following functions can be selected as a calculation circuit/logic circuit.

Furthermore, when upper and lower limit values are the same values, they operate as without upper and lower limits.

Data for U01	Function	Description	Such as U04	Such as U05
4001	Hold	Circuit to hold 1 analog input based on 1 input.	Upper limit	Lower limit
4002	Inversion addition switching	Circuit to invert 1 analog input based on 1 digital input.	Addition value (former clause)	Addition value (latter clause)
4003	Selection 1	Circuit to select 1 analog input and the set value based on 1 digital input.	Set value	No object
4004	Selection 2	Circuit to select the set value 1/2 based on 1 digital input.	Set value 1	Set value 2
5001	Selection 3-1	Circuit to select 2 analog inputs based on "SO01".	No object	No object
⋮	⋮	⋮		
5014	Selection 3-14	Circuit to select 2 analog inputs based on "SO14".	No object	No object
5101	Selection 4-1	Circuit to select 1 analog input and "SO01" based on 1 digital input.	No object	No object
⋮	⋮	⋮		
5114	Selection 4-14	Circuit to select 1 analog input and "SO14" based on 1 digital input.	No object	No object

(4001) Hold

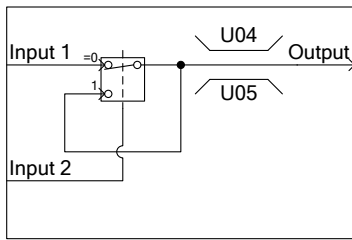

(4002) Inversion addition switching

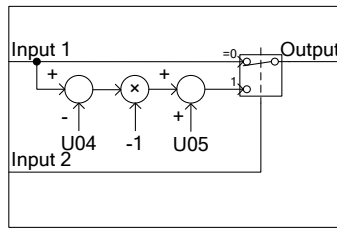

(4003) Selection 1

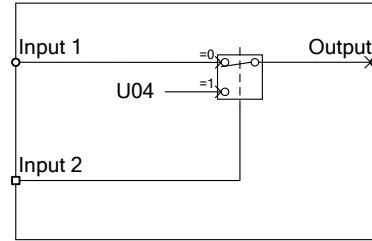

(4004) Selection 2

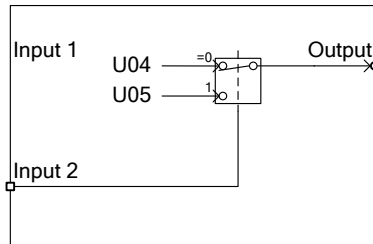
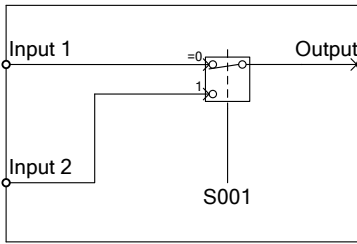
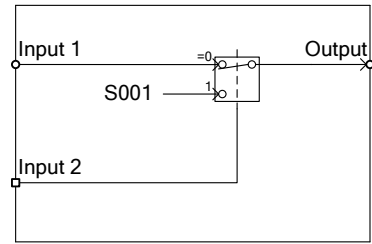
(5001 to 5014)
Selection 3-1 to Selection 3-14(5101 to 5114)
Selection 4-1 to Selection 4-14

■ Output signals

The output of each step of the customizable logic is output to SO01 to SO14.

The outputs SO01 to SO14 differ in configuration depending on the connection mate as shown in the table below. (When establishing connection with any function other than the customizable logic, establish connection through the customizable logic output (CL01 to CL07)).

If the connection destination is:	Configuration	Function codes
Customizable logic input	Select internal step output signals SO01 to SO14 in customizable logic input setting.	U02, U03, etc.
Input to the inverter's sequence processor (e.g., "Select multistep frequency" SSI , "Run forward" FWD)	Select one of the internal step output signals SO01 to SO14 to be connected to customizable logic output signals 1 to 7 (CL01 to CL07).	U71 to U77
	Select an inverter's sequence processor input function to which one of the customizable logic output signals 1 to 7 (CL01 to CL07) is to be connected. (Same as in E01)	U81 to U87
Analog input (Frequency auxiliary setting, PID process command, etc)	Select the internal step outputs SO01 to SO14 to be connected to the customizable logic output signals 1 CL01 to 7 CL07 .	U71 to U77
	Select the analog input function to be connected to the customizable logic output signals 1 CL01 to 7 CL07 . (Same with E61)	U81 to U87
General-purpose digital output (Y terminals)	Select the internal step outputs SO01 to SO14 to be connected to the customizable logic output signals 1 CL01 to 7 CL07 .	U71 to U77
	To specify the general-purpose digital output (terminal [Y]) to be connected to the customizable logic output signals 1 CL01 to 7 CL07 , select CL01 to CL07 on the function selection side of the general-purpose digital output (terminal [Y]).	E20 to E24, E27

If the connection destination is:	Configuration	Function codes
General-purpose analog output (terminal [FM])	Select the internal step outputs SO01 to SO14 to be connected to the customizable logic output signals 1 CL01 to 7 CL07 .	U71 to U77
	To specify the general-purpose analog output (terminal [FM]) to be connected to the customizable logic output signals 1 CL01 to 7 CL07 , select CL01 to CL07 on the function selection side of the general-purpose analog output (terminal [FM]).	F31, F35

Note For the general-purpose digital output (terminal [Y]), the data is renewed over a 5-ms cycle. To securely output a customizable logic signal via Y terminals, include on- or off-delay timers in the customizable logic. Otherwise, short ON or OFF signals may not be reflected on those terminals.

Function code	Name	Data setting range	Default setting
U71	Customizable logic output signal 1 (Output selection)	0: Disable	0
U72	Customizable logic output signal 2 (Output selection)	1: Output of step 1, SO01	0
U73	Customizable logic output signal 3 (Output selection)	2: Output of step 2, SO02	0
U74	Customizable logic output signal 4 (Output selection)	3: Output of step 3, SO03	0
U75	Customizable logic output signal 5 (Output selection)	4: Output of step 4, SO04	0
U76	Customizable logic output signal 6 (output selection)	5: Output of step 5, SO05	0
U77	Customizable logic output signal 7 (output selection)	6: Output of step 6, SO06	0
		7: Output of step 7, SO07	0
		8: Output of step 8, SO08	0
		9: Output of step 9, SO09	0
		10: Output of step 10, SO10	0
		11: Output of step 11, SO11	0
		12: Output of step 12, SO12	0
		13: Output of step 13, SO13	0
		14: Output of step 14, SO14	0

Function code	Name	Data setting range	Default setting
U81	Customizable logic output signal 1 (Function selection)	■ When step outputs are digital: 0 (1000): Select multistep frequency (0 to 1 step) SSI	100
U82	Customizable logic output signal 2 (Function selection)	1 (1001): Select multistep frequency (0 to 3 steps) SS2	100
U83	Customizable logic output signal 3 (Function selection)	2 (1002): Select multistep frequency (0 to 7 steps) SS4	100
U84	Customizable logic output signal 4 (Function selection)	3 (1003): Select multistep frequency (0 to 15 steps) SS8	100
U85	Customizable logic output signal 5 (Function selection)	4 (1004): Select ACC/DEC time (2 steps) RT1	100
U86	Customizable logic output signal 6 (Function selection)	5 (1005): Select ACC/DEC time (4 steps) RT2	
U87	Customizable logic output signal 7 (Function selection)	6 (1006): Enable 3-wire operation HLD	
		7 (1007): Coast to a stop BX	
		8 (1008): Reset alarm RST	
		9 (1009): Enable external alarm trip THR (9 = Active OFF/ 1009 = Active ON)	
		11 (1011): Select frequency command 2/1 Hz2/Hz1	
		13: Enable DC braking DCBRK	
		14 (1014): Select torque limiter level 2/1 TL2/TL1	
		15: Switch to commercial power (50 Hz) SW50	
16: Switch to commercial power (60 Hz) SW60			
17 (1017): UP (Increase output frequency) UP			
18 (1018): DOWN (Decrease output frequency) DOWN			
20 (1020): Cancel PID control Hz/PID			
21 (1021): Switch normal/inverse operation IVS			
22 (1022): Interlock IL			
24 (1024): Enable communications link via RS-485 or fieldbus LE			
25 (1025): Universal DI U-DI			
26 (1026): Enable auto search for idling motor speed at starting STM			
30 (1030): Force to stop STOP (30 = Active OFF/ 1030 = Active ON)			

Function code	Name	Data setting range	Default setting
	(U81 to U87 continued)	33 (1033): Reset PID integral and differential components PID-RST 34 (1034): Hold PID integral component PID-HLD 35 (1035): Select local (keypad) operation LOC 38 (1038): Enable run commands RE 39: Protect motor from dew condensation DWP 40: Enable integrated sequence to switch to commercial power (50 Hz) ISW50 41: Enable integrated sequence to switch to commercial power (60 Hz) ISW60 58 (1058): Reset UP/DOWN frequency STZ 72 (1072): Count the run time of commercial power-driven motor 1 CRUN-M1 81 (1081): Clear all customizable logic timers CLTC 87 (1087): Run command 2/1 FR2/FR1 88: Run forward 2 FWD2 89: Run reverse 2 REV2 98: Run forward FWD 99: Run reverse REV 100: No function assigned NONE 132 (1132): Filter clogging reverse rotation command FRC 133 (1133): Switch PID channel PID2/1	

Function code	Name	Data setting range	Default setting
	(U81 to U87 continued)	171 (1171): PID multistep command <i>PID-SS1</i> 172 (1172): PID multistep command <i>PID-SS2</i> 181 (1181): External PID multistep command <i>EPID-SS1</i> 182 (1182): External PID multistep command <i>EPID-SS2</i> 190 (1190): Cancel timer <i>TMC</i> 191 (1191): Enable timer 1 <i>TM1</i> 192 (1192): Enable timer 2 <i>TM2</i> 193 (1193): Enable timer 3 <i>TM3</i> 194 (1194): Enable timer 4 <i>TM4</i> 201 (1201): External PID control 1 ON command <i>EPID1-ON</i> 202 (1202): Cancel external PID control 1 <i>%EPID1</i> 203 (1203): Switch normal/inverse operation under external PID control 1 <i>EPID1-IVS</i> 204 (1204): Reset external PID1 integral and differential components <i>EPID1-RST</i> 205 (1205): Hold external PID1 integral component <i>EPID1-HLD</i> 211 (1211): External PID control 2 ON command <i>EPID2-ON</i> 212 (1212): Cancel external PID control 2 <i>%EPID2</i> 213 (1213): Switch normal/inverse operation under external PID control 2 <i>EPID2-IVS</i> 214 (1214): Reset external PID2 integral and differential components <i>EPID2-RST</i> 215 (1215): Hold external PID2 integral component <i>EPID2-HLD</i>	

Function code	Name	Data setting range	Default setting
	(U81 to U87 continued)	221 (1221): External PID control 3 ON command EPID3-ON 222 (1222): Cancel external PID control 3 %/EPID3 223 (1223): Switch normal/inverse operation under external PID control 3 EPID3-IVS 224 (1224): Reset external PID3 integral and differential components EPID3-RST 225 (1225): Hold external PID3 integral component EPID3-HLD ■ When step outputs are analog 8001: Auxiliary frequency command 1 8002: Auxiliary frequency command 2 8003: PID process command 1 8004: PID process command 2 8005: PID feedback value 1 8012: Acceleration/ deceleration time ratio setting 8013: Upper limit frequency 8014: Lower limit frequency 8030: PID feedback value 2 8031: Auxiliary input 1 to PID process command 8032: Auxiliary input 2 to PID process command 8033: Flowrate sensor 8041: External PID process command 1 8042: External PID feedback value 1 8043: External PID manual command 1 8044: External PID process command 2 8045: External PID feedback value 2 8046: External PID manual command 2 8047: External PID process command 3 8048: External PID feedback value 3 8049: External PID manual command 3	

■ Notes for using a customizable logic

The customizable logic is calculated for every 5 ms and processed in the following procedure.

- (1) At the start of processing, latch the external input signals to all customizable logics in steps 1 to 14 to ensure concurrency.
- (2) Execute the logic calculations from steps 1 to 14.
- (3) If an output of a particular step applies to an input at the next step, the output of the step having processing priority can be used in the same processing.
- (4) The customizable logic updates 7 output signals at a time.

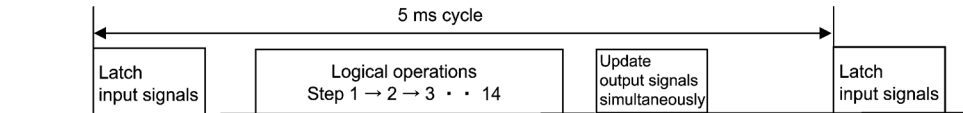

When configuring a logic circuit, take into account the processing order of the customizable logic. Otherwise, a delay in processing of logical operation leads to a signal delay problem, resulting in no expected output, slow processing, or a hazard signal issued.

⚠ CAUTION

Ensure safety before modifying customizable logic related function code settings (U codes and related function codes) or turning ON the "Cancel customizable logic" terminal command *CLC*. Depending upon the settings, such modification or cancellation of the customizable logic may change the operation sequence to cause a sudden motor start or an unexpected motor operation.

An accident or injuries could occur.

■ Customizable logic timer monitor (step selection) (U91, X89 to X93)

The monitor function code can be used to monitor the input/output state in the customizable logics and timer operation status.

Selecting a timer to be monitored

Function code	Function	Remarks
U91	0: Disable monitoring (Monitor data is set to 0.) 1 to 14: Specify the step number to be monitored.	Turning the power off zero-clears the setting value.

Monitoring

Monitored by:	Related function code and LCD monitor display	Monitor item
Communications link	X89 customizable logic (Digital input/output)	Digital I/O data of the step specified with U91 (monitor-specific)
	X90 Customizable logic (Timer monitor)	Timer/counter value specified with U91 (monitor-specific)
	X91 customizable logic (Analog input 1)	Analog input 1 data of the step specified with U91 (monitor-specific)
	X92 customizable logic (Analog input 2)	Analog input 2 data of the step specified with U91 (monitor-specific)
	X93 customizable logic (Analog output)	Analog output data of the step specified with U91 (monitor-specific)

■ Cancel customizable logic -- **CLC** (E01 to E07, data = 80)

This terminal command disables the customizable logic temporarily. Use it to run the inverter without using the customizable logic circuit or timers for maintenance or other purposes.

<i>CLC</i>	Function
OFF	Enable customizable logic (Depends on the U00 setting)
ON	Disable customizable logic

 **Note** Before changing the setting of **CLC**, ensure safety. Turning **CLC** ON disables the sequence of the customizable logic, causing a sudden motor start depending upon the settings.

■ Clear all customizable logic timers -- **CLTC** (E01 to E07, data = 81)

Assigning **CLTC** to any of the general-purpose digital input terminals and turning it ON resets all of the general-purpose timers and counters in the customizable logic. Use this command when the timings between the external sequence and the internal customizable logic do not match due to a momentary power failure or other reasons so that resetting and restarting the system is required.

<i>CLTC</i>	Function
OFF	Ordinary operation
ON	Reset all of the general-purpose timers and counters in the customizable logic. (To operate the timers and counters again, revert CLTC to OFF.)

6.3.14 U1 codes (Customizable logic functions)

U101 to U106

Customizable Logic (Conversion point 1 (X1, Y1), Conversion point 2 (X2, Y2), Conversion point 3 (X3, Y3))

U101 to U106 specify the three operating points for automatically calculating coefficients (KA, KB and KC) in conversion 1 ($KA \times \text{Input } 1^2 + KB \times \text{Input } 1 + KC$). Input signals (e.g., flowrate signal) and coefficients (KA, KB and KC) produce target signals (e.g., target pressure). (Linearize function)

- Data setting range: -999.00 to 0.00 to 9990.00

Linearize characteristics example

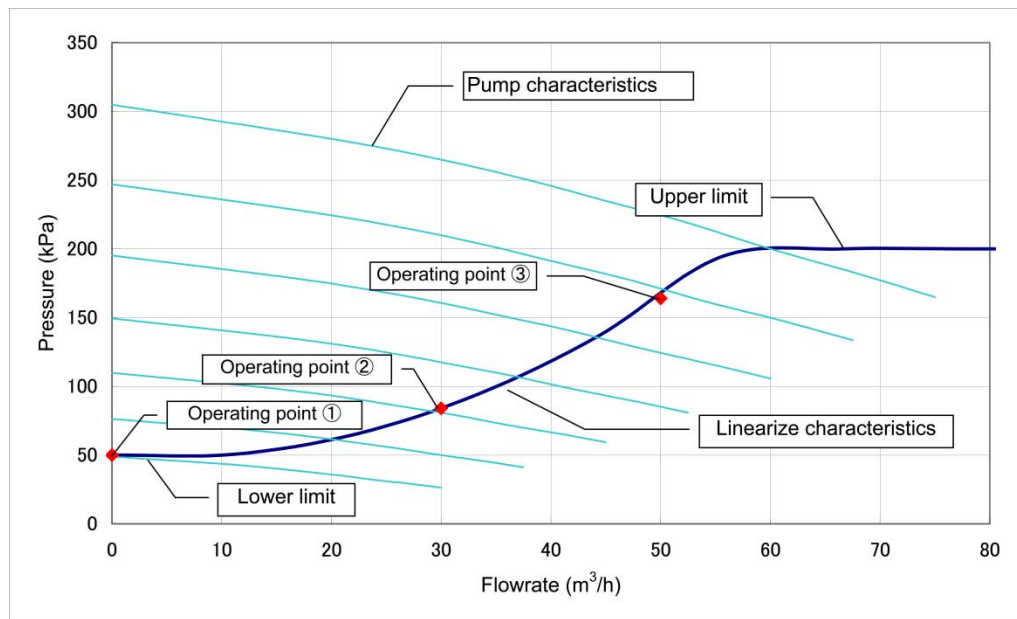

U107

Customizable Logic (Automatic calculation of conversion coefficients)

U107 automatically calculates conversion coefficients (KA, KB and KC) according to the three operating points defined by U101 to U106.

The calculation results will be saved in U92 to U97. U107 automatically reverts to "0."

Data for U107	Function
0	Disable
1	Execute calculation (Arithmetic circuit: Conversion 1 (3001) $KA \times \text{Input } 1^2 + KB \times \text{Input } 1 + KC$)

□ Customizable logic configuration samples

Configuration sample 1: Switch two or more signals using a single switch

When switching between **Hz2/Hz1** (Select frequency command 2/1) and **TL2/TL1** (Select torque limiter level 2/1) with a single switch, using a customizable logic instead of a conventional external circuit reduces the number of the required general-purpose input terminals to one as shown below.

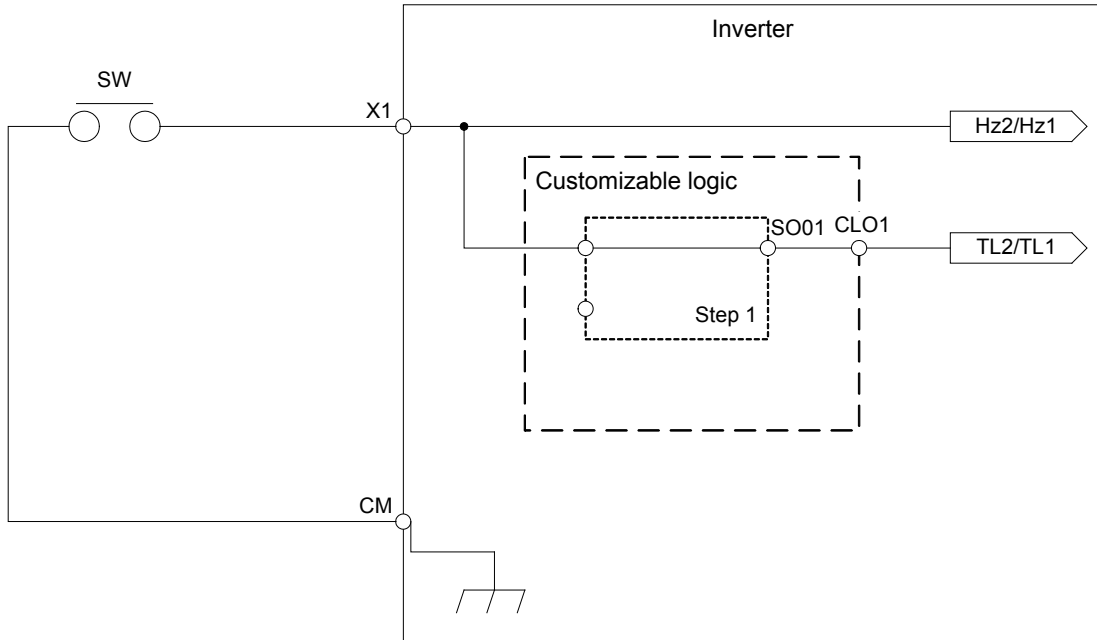

To configure the above customizable logic, set function codes as listed below. The "Type of timer" and "Time setting" require no modification unless otherwise specified.

Function Code		Setting Data	Function	Remarks	
E01	Terminal [X1] Function	12	Select frequency command, Hz2/Hz1	Concurrently usable also as a general-purpose input terminal.	
U00	Customizable Logic (Mode selection)	1	Enable		
U01	Customizable Logic: Step 1	(Logic circuit)	1	Through output + General-purpose timer	Operation selection
U03		(Input 1)	4001	Terminal [X1] input signal, X1	
U71	Customizable Logic: Output Signal 1	(Output selection)	1	Output of step 1, SO01	
U81		(Function selection)	14	Select torque limiter level 2/1, TL2/TL1	

Configuration sample 2: Put two or more output signals into one

When putting two or more output signals into one, using a customizable logic instead of a conventional external circuit reduces the number of the required general-purpose output terminals and eliminates external relays as shown below.

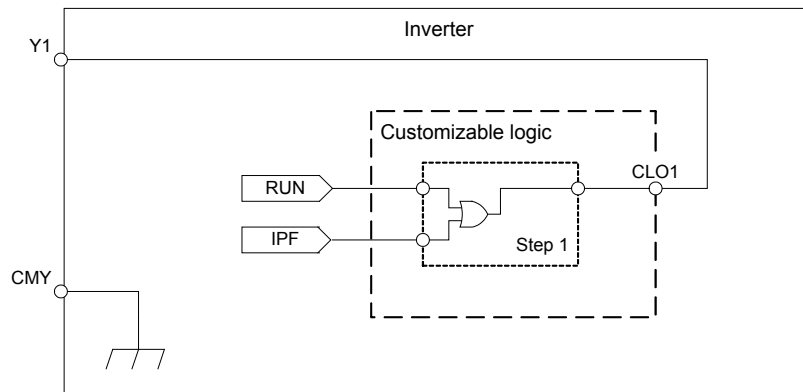

To configure the above customizable logic, set function codes as listed below. The "Type of timer" and "Time setting" require no modification unless otherwise specified.

Function Code		Setting Data	Function	Remarks	
E20	Terminal [Y1] Function	111	Customizable logic output signal 1, CLO1		
U00	Customizable Logic (Mode selection)	1	Enable		
U01	Customizable Logic: Step 1	(Logic circuit)	3	ORing + General-purpose timer	Operation selection
U02		(Input 1)	0	Inverter running, RUN	
U03		(Input 2)	6	Auto-restarting after momentary power failure, IPF	
U71	Customizable Logic: Output Signal 1	(Output selection)	1	Output of step 1, SO01	
U81		(Function selection)	100	No function assigned, NONE	

Configuration sample 3: One-shot operation

When starting the inverter by short-circuiting the SW-FWD or SW-REV switch and stopping it by short-circuiting the SW-STOP switch (which are functionally equivalent to depression of the FWD/REV key or STOP key on the keypad, respectively), using a customizable logic instead of a conventional external circuit simplifies the external circuit as shown below.

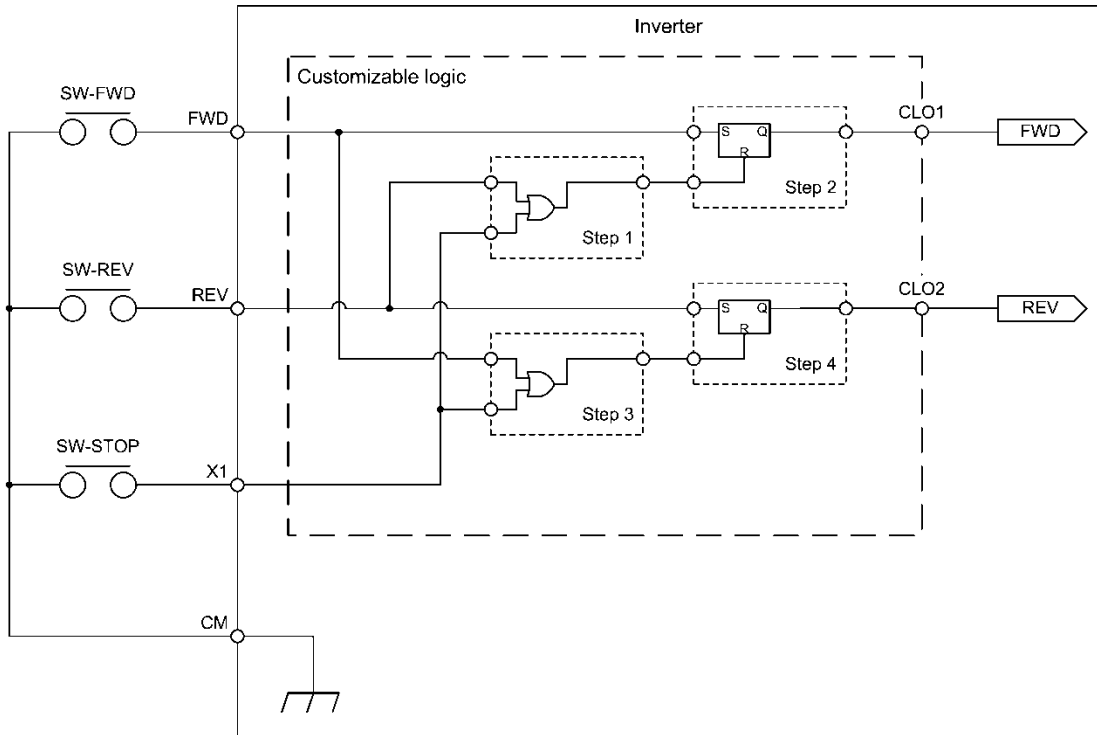

To configure the above customizable logic, set function codes as listed below. The "Type of timer" and "Time setting" require no modification unless otherwise specified.

Function Code		Setting Data	Function	Remarks	
E01	Terminal [X1] Function	100	No function assigned, NONE		
E98	Terminal [FWD] Function	100	No function assigned, NONE		
E99	Terminal [REV] Function	100	No function assigned, NONE		
U00	Customizable Logic (Mode selection)	1	Enable		
U01	Customizable Logic: Step 1	(Logic circuit)	3	ORing + General-purpose timer	Operation selection
U02		(Input 1)	4011	Terminal [REV] input signal, REV	
U03		(Input 2)	4001	Terminal [X1] input signal, X1	
U06	Customizable Logic: Step 2	(Logic circuit)	6	Reset priority flip-flop + General-purpose timer	Operation selection
U07		(Input 1)	4010	Terminal [FWD] input signal, FWD	
U08		(Input 2)	2001	Output of step 1, SO01	

Function Code			Setting Data	Function	Remarks
U11	Customizable Logic: Step 3	(Logic circuit)	3	ORing + General-purpose timer	Operation selection
U12		(Input 1)	4010	Terminal [FWD] input signal, FWD	
U13		(Input 2)	4001	Terminal [X1] input signal, XI	
U16	Customizable Logic: Step 4	(Logic circuit)	6	Reset priority flip-flop + General-purpose timer	Operation selection
U17		(Input 1)	4011	Terminal [REV] input signal, REV	
U18		(Input 2)	2003	Output of step 3, SO03	
U71	Customizable Logic: Output Signal 1	(Output selection)	2	Output of step 2, SO02	FWD command
U72	Customizable Logic: Output Signal 2		4	Output of step 4, SO04	REV command
U81	Customizable Logic: Output Signal 1	(Function selection)	98	Run forward, FWD	
U82	Customizable Logic: Output Signal 2		99	Run reverse, REV	

6.3.15 y codes (Link functions)

y01 to y20	RS-485 Communication 1 and 2
------------	------------------------------

Up to two RS-485 communications ports are available as listed below.

Port	Route	Function code	Applicable equipment
Port 1	RS-485 communications link (via the RJ-45 connector prepared for keypad connection)	y01 through y10	Standard keypad FRENIC Loader Host equipment
Port 2	RS-485 communications link (via terminals DX+, DX- and SD on the control PCB)	y11 through y20	Inverter support loader (FRENIC loader)

To connect any of the applicable devices, follow the procedures shown below.

(1) Standard keypad

The standard keypad allows you to run and monitor the inverter. It can be used independent of the y code setting.

(2) FRENIC Loader

Connecting your computer running FRENIC Loader to the inverter via the RS-485 communications link (port 1 and 2), you can monitor the inverter's running status information, edit function codes, and test-run the inverters.

 For the setting of y codes, refer to the descriptions of y01 to y20.

 **Note** FRENIC-HVAC series of inverters has a USB port. To use the FRENIC Loader via the USB port, simply set the station address (y01 or y20) to "1" (factory default).

(3) Host equipment

The inverter can be managed and monitored by connecting host equipment such as a PC and PLC to the inverter. Modbus RTU, Metasys N2, BACnet and Fuji general-purpose inverter protocol are available for communications protocols.

 For details, refer to the RS-485 Communication User's Manual.

■ Station address (y01 for port 1 and y11 for port 2)

y01 or y11 specifies the station address for the RS-485 communications link. The table below lists the protocols and the station address setting ranges.

Protocol	Station address	Broadcast address
Modbus RTU protocol	1 to 247	0
SX protocol (FRENIC Loader command protocol)	1 to 255	-
FRENIC Loader protocol	1 to 255	None
FUJI general-purpose inverter protocol	1 to 31	99
Metasys N2	0 to 255	-
BACnet	0 to 127	255

- If any wrong address beyond the above range is specified, no response is returned since the inverter will be unable to receive any enquiries except the broadcast message.
- To use FRENIC Loader via the RS-485 communications link (port 1 and 2), set the station address that matches the connected computer.

■ **Communications error processing (y02 for port 1 and y12 for port 2)**

y02 or y12 specifies the error processing to be performed if an RS-485 communications error occurs.

RS-485 communications errors include logical errors (e.g., address error, parity error, framing error), transmission protocol error, and physical errors (e.g., no-response error specified by y08 and y18). The inverter can recognize such an error only when it is configured with a run or frequency command sourced through the RS-485 communications link and it is running.

Data for y02, y12	Function
0	Immediately trip, displaying an RS-485 communications error (Er8 for y02 and ErP for y12). (The inverter stops with alarm issue.)
1	Run during the period specified by the error processing timer (y03, y13), display an RS-485 communications error (Er8 for y02 and ErP for y12), and then stop operation. (The inverter stops with alarm issue.)
2	Retry communication during the period specified by the error processing timer (y03, y13). If a communications link is recovered, continue operation. Otherwise, display an RS-485 communications error (Er8 for y02 and ErP for y12) and stop operation. (The inverter stops with alarm issue.)
3	Continue to run even when a communications error occurs.



For details, refer to the RS-485 Communication User's Manual.

■ **Timer (y03 for port 1 and y13 for port 2)**

y03 or y13 specifies an error processing timer.

If the specified timer count has elapsed due to no response from the other end when a query has been issued, the inverter interprets it as an error occurrence. See the "No-response error detection time (y08, y18)" given on the next page.

- Data setting range: 0.0 to 60.0 (s)

■ **Baud rate (y04 for port 1 and y14 for port 2)**

y04 or y14 specifies the transmission speed for RS-485 communication.

For FRENIC Loader (via the RS-485 communications link), specify the transmission speed that matches the connected computer.

* "6: 76800" is available at ROM version 2450 or later. But, note that it can be used for BACnet protocol. If it is set to 5 under other protocol, actual baud rate will be limited to 38400 bps.

Data for y04 and y14	Transmission speed (bps)
0	2400
1	4800
2	9600
3	19200
4	38400
6	76800 (Only for BACnet)

■ **Data length (y05 for port 1 and y15 for port 2)**

y05 or y15 specifies the character length for RS-485 communication.

For FRENIC Loader (via the RS-485 communications link), no setting is required since Loader automatically sets 8 bits. (The same applies to the Modbus RTU protocol.)

Data for y05 and y15	Data length
0	8 bits
1	7 bits

■ Parity check (y06 for port 1 and y16 for port 2)

y06 or y16 specifies the property of the parity bit.

For FRENIC Loader, no setting is required since Loader automatically sets the even parity.

Data for y06 and y16	Parity
0	None (2 stop bits for Modbus RTU)
1	Even parity (1 stop bit for Modbus RTU)
2	Odd parity (1 stop bit for Modbus RTU)
3	None (1 stop bit for Modbus RTU)

■ Stop bits (y07 for port 1 and y17 for port 2)

y07 or y17 specifies the number of stop bits.

For FRENIC Loader, no setting is required since Loader automatically sets 1 bit.

For the Modbus RTU protocol, no setting is required since the stop bits are automatically determined associated with the property of parity bits.

Data for y07 and y17	Stop bit(s)
0	2 bits
1	1 bit

■ No-response error detection time (y08 for port 1 and y18 for port 2)

y08 or y18 specifies the timeout period for receiving a response from the host equipment (such as a computer or PLC) in RS-485 communication, in order to detect network breaks. This applies to the machinery that accesses the host equipment at the predetermined intervals.

Data for y08 and y18	No-response error detection
OFF	No detection
1 to 60	1 to 60 s

If a response timeout occurs, the inverter starts communications error processing.

For communications error processing, refer to y02 and y12.

■ Response interval (y09 for port 1 and y19 for port 2)

y09 or y19 specifies the latency time after the end of receiving a query sent from the host equipment (such as a computer or PLC) until the start of sending the response. This enables the inverter to control the response timing to match the host equipment that is slow in processing.

- Data setting range: 0.00 to 1.00 (s)

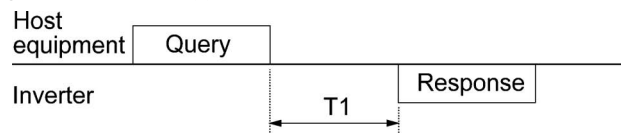

$$T1 = \text{Response interval} + \alpha$$

where α is the processing time inside the inverter. α may vary depending on the processing status and the command processed in the inverter.

 For details, refer to the RS-485 Communication User's Manual.

 **Note** When configuring the inverter with FRENIC Loader via the RS-485 communications link, pay sufficient attention to the performance and configuration of the PC and protocol converter such as USB-RS-485 converter. Some protocol converters monitor the communications status and switch between sending and receiving of transmission data with a timer.

■ Protocol selection (y10, y20)

y10 specifies the communications protocol for port 1.

For FRENIC Loader (via the RS-485 communications link), only y10 can be used for protocol selection. Set the y10 data at "1."

Data for y10, y20	Protocol
0	Modbus RTU protocol
1	SX protocol (loader protocol)
2	Fuji general-purpose inverter protocol
3	Metasys N2 protocol
5	BACnet protocol
50	Communications link pump control protocol (y20-specific)

y60, y61

BACnet Device instance number (Upper and Lower)

These function code are available at ROM version 2100 or later.

These settings specify Device instance number for identifying itself on the application layer of BACnet protocol.

Setting method is different by y61 setting value as below:

Data for y61	Device instance number	Setting range ^{*1}
0	(y60 * 1000) + MAC address ^{*2}	(y60 * 1000) + (0 to 127)
128 to 999	(y60 * 1000) + y61	(y60 * 1000) + (128 to 999)

*1 Maximum setting range for device instance number is: 0 to 4194302.

*2 MAC address is specified by y01 or y11.

y95

Data Clear Processing for Communications Error

Data for y95	Function
0	Do not clear the data of function codes Sxx when a communications error occurs. (compatible with the conventional inverters)
1	Clear the data of function codes S01/S05/S19 when a communications error occurs.
2	Clear the run command assigned bit of function code S06 when a communications error occurs.
3	Clear both data of S01/S05/S19 and run command assigned bit of S06 when a communications error occurs.

* Related alarms: Er8, ErP, Er4, Er5

y98	Bus Link Function (Mode selection)	(Refer to H30.)
------------	---	------------------------

Refer to the description of H30.

y99	Loader Link Function (Mode selection)
------------	--

This is a link switching function for FRENIC Loader. Rewriting the data of y99 to enable RS-485 communications from Loader helps Loader send the inverter the frequency and/or run commands. Since the data to be set in the function code of the inverter is automatically set by Loader, no keypad operation is required.

With Loader being selected as a run command source, if the computer runs out of control and cannot be stopped by a stop command sent from Loader, disconnect the RS-485 communications cable from the port 1 or the USB cable, connect a keypad instead, and reset the y99 data to "0." The setting of "0" in y99 means that the run and frequency command source specified by H30 takes place instead of FRENIC Loader.

Note that the inverter cannot save the setting of y99. When the power is turned off, the data in y99 is lost (y99 is reset to "0").

Data for y99	Function	
	Frequency command	Run command
0	Follow H30 and y98 data	Follow H30 and y98 data
1	Via RS-485 link (FRENIC Loader)	Follow H30 and y98 data
2	Follow H30 and y98 data	Via RS-485 link (FRENIC Loader)
3	Via RS-485 link (FRENIC Loader)	Via RS-485 link (FRENIC Loader)

6.3.16 T codes (Timer functions)

T codes configure timer operation.

The timer operation can be configured easily in Programming mode as follows.

PRG > 2(Function Code) > 5(Timer Setup) > 1 to 6(Sub menu #)

For detailed setting procedure, refer to Chapter 5, Section 5.6.3.5 "Configuring Timer Operation."

T01	Timer 1 Operation (Operating mode) T06: Timer 2 Operation (Operating mode) T11: Timer 3 Operation (Operating mode) T16: Timer 4 Operation (Operating mode)
------------	---

The inverter supports timer operation to run/stop the motor and output digital signals according to the preset schedule when the real-time clock is enabled, making use of the date & time information.

It is possible to:

- set the day of the week and start/end times for a maximum of four timers,
- set a maximum of 20 pause dates per year,
- select whether to run the inverter or output external signals for each timer, and
- enable/disable timer operation or cancel timer operation by digital input signals **TMI** to **TM4** or **TMC**, respectively.

Note: To use digital input signals **TMI** to **TM4** and **TMC**, it is necessary to assign them to digital input terminals with E01 to E07 (data = 190 to 194) beforehand.

- Data setting range: 0 to 3

Data for T01	Function
0	Disable
1	Enable (Inverter run) At the set time, the inverter runs. (Input of a run command and frequency command is separately required.)
2	Enable (Digital output signals) At the set time, the related one of digital output signals TMD , TMD1 to TMD4 comes ON. (No input of a run command or frequency command is required.)
3	Enable (Inverter run + Digital output signals) At the set time, the inverter runs and the related one of digital output signals TMD , TMD1 to TMD4 comes ON. (Input of a run command and frequency command is separately required.)

Note: To use digital output signals **TMD**, **TMD1** to **TMD4**, it is necessary to assign them to digital output terminals with E20 to E24 and E27 beforehand.

- "In timer operation" signal: **TMD** (E20 to E24 and E27, data = 190)
- "Timer 1 enabled" signal: **TMD1** (E20 to E24 and E27, data = 191)
- "Timer 2 enabled" signal: **TMD2** (E20 to E24 and E27, data = 192)
- "Timer 3 enabled" signal: **TMD3** (E20 to E24 and E27, data = 193)
- "Timer 4 enabled" signal: **TMD4** (E20 to E24 and E27, data = 194)



For details of the setting procedure, refer to Chapter 5, Section 5.6.3.5 "Configuring the timer operation."

<p>T02 T03 T04</p>	<p>Timer 1 Operation (Start time) (End time) (Start day of the week)</p> <p>T07: Timer 2 (Start time) T08: Timer 2 (End time) T09: Timer 2 (Start day of the week) T12: Timer 3 (Start time) T13: Timer 3 (End time) T14: Timer 3 (Start day of the week) T17: Timer 4 (Start time) T18: Timer 4 (End time) T19: Timer 4 (Start day of the week)</p>
----------------------------	---

These function codes specify the start time, end time, and start day of the week for timer operation; T02 to T4 for Timer 1, T07 to T09 for Timer 2, T12 to T14 for Timer 3, and T17 to T19 for Timer 4.

■ **Timer Operation (Start time/End time) (T02/T03, T07/T08, T12/T13, T17/T18)**

These function codes specify the start time and end time of timer operation. (Possible to specify in the special menu)

The magnitude relation between the start and end times and the timer operation are as follows.

Magnitude relation	Timer operation
Start time < End time (Ex. Start time: 8:00, End time: 18:00)	Timer operation starts at the start time of the effective day of the week and continues to the end time of that day.
Start time ≥ End time (Ex. Start time: 16:00, End time: 3:00)	Timer operation starts at the start time of the effective day of the week and continues to the end time of the next day (even if the next day is not an effective day of the week).

■ **Timer Operation (Start day of the week) (T04, T09, T14, T19)**

These function codes specify the start day of the week for timer operation. More than one day of the week can be specified. (Possible only on the dedicated menu)

6 bit	5 bit	4 bit	3 bit	2 bit	1 bit	0 bit
Sunday	Saturday	Friday	Thursday	Wednesday	Tuesday	Monday

 For details of the setting procedure, refer to Chapter 5, Section 5.6.3.5 "Configuring the timer operation."

T06	Timer 2 Operation (Operating mode)	(Refer to T01.)
------------	---	------------------------

For details of the setting procedure, refer to the description of T01.

T07	Timer 2 Operation (Start time)	(Refer to T02.)
T08	(End time)	(Refer to T03.)
T09	(Start day of the week)	(Refer to T04.)

For details of the setting procedure, refer to the descriptions of T02 to T04.

T11	Timer 3 Operation (Operating mode)	(Refer to T01.)
------------	---	------------------------

For details of the setting procedure, refer to the description of T01.

T12	Timer 3 Operation (Start time)	(Refer to T02.)
T13	(End time)	(Refer to T03.)
T14	(Start day of the week)	(Refer to T04.)

For details of the setting procedure, refer to the descriptions of T02 to T04.

T16	Timer 4 Operation (Operating mode)	(Refer to T01.)
------------	---	------------------------

For details of the setting procedure, refer to the description of T01.

T17	Timer 4 Operation (Start time)	(Refer to T02.)
T18	(End time)	(Refer to T03.)
T19	(Start day of the week)	(Refer to T04.)

For details of the setting procedure, refer to the descriptions of T02 to T04.

T51 to T70	Timer Operation (Pause date 1) to (Pause date 20)
-------------------	--

These function codes specify a maximum of 20 pause dates per year for preventing the inverter exceptionally from running, e.g., on holidays even if timer operation is enabled. On pause dates specified, no timer operation is performed even during timer operation period.

It is also possible to enable or disable each pause date setting.

The following two choices of pause date settings are available.

- Setting the month and day (e.g., January 1)
- Setting the day of the week (e.g., January, 2nd Sunday)

Function code	Item to be set	Function (Setting range)	
T51 to T70	Pause day (Month and day)	0 to 65535	
	bit 15	Mode selection	0: Disable pause date setting 1: Enable pause dates setting
	bit 14	--	-
	bit 13	Configuration format	0: Day of the week, 1: Date
	bit 12	Month	• January to December
	bit 11		
	bit 10		
	bit 9		
	bit 8	Day or week *1	• 1st to 31st (when bit 13 = 1 (Date)) • 1st to 4th week, final week (when bit 13 = 0 (Day of the week))
	bit 7		
	bit 6		
	bit 5		
	bit 4	Day of the week	• Monday to Sunday (when bit 13 = 0 (Day of the week))
	bit 3		
	bit 2		
bit 1			
bit 0			

*1 The content differs depending upon the setting on bit 3.

For details, refer to Chapter 5, Section 5.6.3.5 "Configuring timer operation."

6.3.17 K codes (Keypad functions)

K01	LCD Monitor (Language selection)
------------	---

K01 selects the language to be display on the LCD.

- Data setting range: 0 to 19, 100

Data for K01	Language	Data for K01	Language	Data for K01	Language
0	Japanese	-	-	14	Portuguese
1	English	8	Russian	15	Dutch
2	German	9	Greek	16	Malay
3	French	10	Turkish	17	Vietnamese
4	Spanish	11	Polish	18	Thai
5	Italian	12	Czech	19	Indonesian
6	Chinese	13	Swedish	100	User-customized language



Language selection can be made easily in Programming mode as follows.

PRG > 1(Start-up) > 1(Language)

For detailed setting procedure, refer to Chapter 5, Section 5.6.2.1 "Setting the display language."

K02	Backlight OFF Time
------------	---------------------------

K02 specifies the backlight OFF time of the LCD on the keypad.

When no keypad operation is performed during the time specified by K02, the backlight goes OFF.

- Data setting range: 1 to 30 (min.), OFF

Data for K02	Function
OFF	Always turn the backlight OFF
1 to 30 (min.)	Turn the backlight OFF automatically after no keypad operation is performed during the backlight OFF time.



The backlight OFF time can be configured easily in Programming mode as follows.

PRG > 1(Start-up) > 4(Disp Setting) > 1 to 18(Sub menu number)

For detailed setting procedure, refer to Chapter 5, Section 5.6.2.4 "Specifying the running status item to be monitored."

K03 K04	LCD monitor (Backlight brightness control) (Contrast control)
--------------------	--

These function codes control the backlight brightness and contrast.

- Data setting range: 0 to 10

■ Backlight brightness control (K03)

Data for K03	0, 1, 2, 8, 9, 10
0	Dark ←————→ Light

■ Contrast control (K04)

Data for K04	0, 1, 2, 8, 9, 10
0	Light ←————→ Dark

The backlight brightness and contrast can be controlled easily in Programming mode as follows.

PRG > 1(Start-up) > 4(Disp Setting) > 15(Brightness)

PRG > 1(Start-up) > 4(Disp Setting) > 16(Contrast)

For detailed setting procedure, refer to Chapter 5, Section 5.6.2.4 "Specifying the running status item to be monitored."

K08	LCD Monitor Status Display/Hide Selection
------------	--

K08 selects whether to display or hide the status messages to be monitored on the LCD monitor on the keypad.

- Data setting range: 0, 1

Data for K08	Function
0	Hide status messages
1	Display status messages (factory default)

<LCD on the keypad>



- Status messages**
- Capacitor lifetime being measured
 - Undervoltage
 - No input to EN
 - No input to RE
 - Input to BX
 - Fire mode stopped
 - In restart mode after momentary power failure
 - During retry
 - Rotation direction limited
 - Running in fire mode
 - Being driven by commercial power
 - Dew condensation prevention in operation
 - Under output limiting
 - Under overload prevention control
 - Anti-jam function being activated
 - Filter clogging prevention
 - Boost function
 - In recovery operation from PV level error
 - Under wet-bulb temperature presumption control
 - Motor stopped due to slow flowrate
 - Load factor being measured

K10	Main Monitor (Display item selection) K16: Sub monitor 1 (Display item selection) K17: Sub monitor 2 (Display item selection)
------------	--

K10, K16 and K17 specify the running status item to be monitored and displayed on the main monitor, sub monitor 1 and sub monitor 2, respectively.

Data setting range: Main monitor (K10) 1 to 83
 Sub monitor 1 (K16) 1 to 83 ("Speed monitor" not selectable)
 Sub monitor 2 (K17) 1 to 83 ("Speed monitor" not selectable)

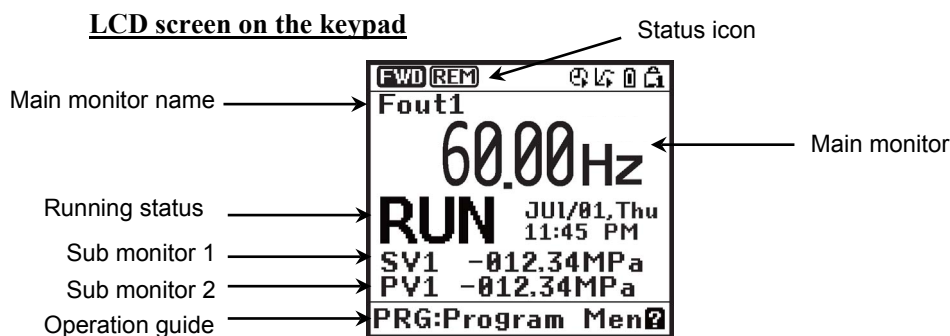

Table 6.7 Monitor Items (Selectable anytime)

Monitor item	Monitor name	LCD indication	Unit	Meaning of displayed value	Function code data for K10
Speed monitor	Function code K11 specifies what to be displayed on the main monitor.				0
Output frequency 1 (before slip compensation)	Output frequency (Synchronous)	Output f1	Hz	Output frequency (Hz)	(K11 = 1)
Output frequency 2 (after slip compensation)	Output frequency (Primary)	Output f2	Hz	Output frequency (Hz)	(K11 = 2)
Reference frequency	Reference frequency	Setting f	Hz	Reference frequency (Hz)	(K11 = 3)
Motor speed	Motor speed	Motor	r/min	Output frequency (Hz) x $\frac{120}{P01}$	(K11 = 4)
Load shaft speed	Load shaft speed	Machine	r/min	Output frequency (Hz) x K30	(K11 = 5)
Display speed (%)	Display speed (%)	Speed %	%	$\frac{\text{Output frequency}}{\text{Maximum frequency}} \times 100$	(K11 = 8)
Output current	Output current	Output I	A	Current output from the inverter in RMS	13
Output voltage	Output voltage	Output V	V	Voltage output from the inverter in RMS	14
Calculated torque	Calculated torque	Torque	%	Motor output torque in % (Calculated value)	18
Input power	Input power	Consumption W	kW	Input power to the inverter	19
Load factor	Load factor	Load factor	%	Load factor of the motor in % as the rated output being at 100%	25

Monitor item	Monitor name	LCD indication	Unit	Meaning of displayed value	Function code data for K10
Motor output	Motor output	M output	kW	Motor output in kW	26
Analog input (Note 1)	Analog input	AMon	-	An analog input to the inverter in a format suitable for a desired scale. Refer to function codes below. Terminal [12]: C59, C60 Terminal [C1]: C65, C66 Terminal [V2]: C71, C72	27
Input watt-hour	Input watt-hour	Cumulative W	-	$\frac{\text{Input watt - hour (kWh)}}{100}$ Refer to function code K31 for details.	35



The following monitor items appear only when the related PID control or external PID control is enabled. Items for the PID control and external PID control being disabled cannot be displayed.

Table 6.8 Monitor Items (Selectable when PID control or external PID control is enabled)

Monitor item	Monitor name	LED indicator	Unit	Meaning of displayed value	Function code data for K10
PID command (Note 2)	PID final SV	SV	J105 J205	PID command and its feedback converted into physical quantities of the object to be controlled.	50
PID feedback amount (Note 2)	PID final PV	PV	--	The display unit can be selected with Function code J105 and J205.	51
PID output (Note 2)	PID MV	MV	%	PID output in %, assuming the maximum frequency (F03) as 100%	52
PID control 1 command (Note 3)	PID1 SV	SV1	--	PID control 1 command and its feedback converted into physical quantities of the object to be controlled. The display unit can be selected with Function code J105.	53
PID control 1 feedback amount (Note 3)	PID1 PV	PV1	--		54
PID control 2 command (Note 3)	PID2 SV	SV2	--	PID control 2 command and its feedback converted into physical quantities of the object to be controlled. The display unit can be selected with Function code J205.	55
PID control 2 feedback amount (Note 3)	PID2 PV	PV2	--		56
External PID control 1 command value (Note 4)	External PID1, final SV	E. SV1F			60
External PID control 1 feedback amount (Note 4)	External PID1, final PV	E. PV1F			61

Monitor item	Monitor name	LED indicator	Unit	Meaning of displayed value	Function code data for K10
External PID control 1 output (Note 4)	External PID1, MV	E. MV1	--	PID output in %, assuming the maximum frequency (F03) as 100% The display unit can be selected with Function code J505.	62
External PID control 1 manual command (Note 5)	External PID1, manual	E. MU1	%		63
External PID control 1 command (Note 6)	External PID1 SV	E. SV1	%		64
External PID control 1 feedback amount (Note 6)	External PID1 PV	E. PV1	--	The display unit can be selected with Function code J505.	65
External PID control 2 command (Note 7)	External PID2 SV	E. SV2	%		70
External PID control 2 feedback amount (Note 7)	External PID2 PV	E. PV2	--	The display unit can be selected with Function code J605.	71
External PID control 2 output (Note 7)	External PID2 MV	E. MV2	--	The display unit can be selected with Function code J605.	72
External PID control 2 manual command (Note 8)	External PID2, manual	E. MU2	%		73
External PID control 3 command (Note 9)	External PID3 SV	E. SV3	%		80
External PID control 3 feedback amount (Note 9)	External PID3 PV	E. PV3	--	The display unit can be selected with Function code J655.	81
External PID control 3 output (Note 9)	External PID1 MV	E. MV3	--	The display unit can be selected with Function code J655.	82
External PID control 3 manual command (Note 10)	External PID3, manual	E. MU3	%		83

(Note 1) The analog input monitor appears only when it is assigned to terminal [12], [C1] or [V2] with any of E61 to E63 (data = 20).

(Note 2) These items appear when J101 (PID control 1) or J201 (PID control 2) \neq 0. The  or  appears on the status icon field, indicating that the internal PID is selected.

(Note 3) These items appear when:
- J101 (PID control 1) or J201 (PID control 2) \neq 0
- J101 (PID control 1) or J104 (PID control 1) \neq 0

(Note 4) These items appear when J501 (External PID control 1) \neq 0.

(Note 5) These items appear when J501 (External PID control 1) \neq 0 and %*EPID1* ("Cancel external PID control 1") is assigned to any digital input terminal.

- (Note 6) These items appear when J501 or J504 (External PID control 1) ≠ 0.
- (Note 7) These items appear when J601 (External PID control 2) ≠ 0.
- (Note 8) This item appears when J601 (External PID control 1) ≠ 0 and %EPID2 ("Cancel external PID control 2") is assigned to any digital input terminal.
- (Note 9) These items appear when J651 (External PID control 3) ≠ 0.
- (Note 10) This item appears when J651 (External PID control 3) ≠ 0 and %EPID3 ("Cancel external PID control 3") is assigned to any digital input terminal.

 The monitor items can be selected easily in Programming mode as follows.
PRG > 1(Start-up) > 4(Disp Setting) > 2(Main Monitor)
 For detailed setting procedure, refer to Chapter 5, Section 5.6.2.4 "Specifying the running status item to be monitored."

K11	Main Monitor (Speed monitor item)	(Refer to K10.)
------------	--	------------------------

For details about the speed monitor items, refer to the description of K10.

 The monitor items can be selected easily in Programming mode as follows.
PRG > 1(Start-up) > 4(Disp Setting) > 3(Speed Monitor)
 For detailed setting procedure, refer to Chapter 5, Section 5.6.2.4 "Specifying the running status item to be monitored."

K12	Main Monitor (Display when stopped)
------------	--

K12 specifies whether the specified value (data = 0) or the output value (data = 1) to be displayed on the main monitor when the inverter is stopped. The monitored item depends on the K11 (Main monitor, Speed monitor item) setting as shown below.

Data for K11	Monitored item	What to be displayed when the inverter stopped	
		K12 = 0: Specified value	K12 = 1: Output value
1	Output frequency 1 (before slip compensation)	Reference frequency	Output frequency 1 (before slip compensation)
2	Output frequency 2 (after slip compensation)	Reference frequency	Output frequency 2 (after slip compensation)
3	Reference frequency	Reference frequency	Reference frequency
4	Motor speed	Reference motor speed	Motor speed
5	Load shaft speed	Reference load shaft speed	Load shaft speed
8	Display speed (%)	Reference display speed	Display speed

 The monitor items can be selected easily in Programming mode as follows.
PRG > 1(Start-up) > 4(Disp Setting) > 3(Speed Monitor)
 For detailed setting procedure, refer to Chapter 5, Section 5.6.2.4 "Specifying the running status item to be monitored."

K15	Sub Monitor (Display type)
------------	-----------------------------------

K15 selects the display type of the LCD sub monitor on the keypad--Numeric values (= 0) or Bar charts (= 1).

- Data setting range: 0, 1

Data for K15	Function
0	Numeric values (factory default)
1	Bar charts

Sub monitor: Numeric values (K15 = 0)

Sub monitor: Bar charts (K15 = 1)

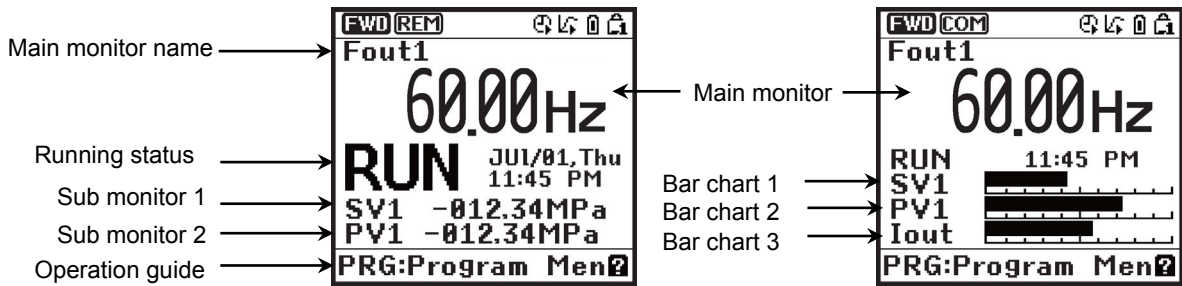

The display type can be selected easily in Programming mode as follows.

PRG > 1(Start-up) > 4(Disp Setting) > 1(Disp Mode)

For detailed setting procedure, refer to Chapter 5, Section 5.6.2.4 "Specifying the running status item to be monitored."

K16 K17	Sub Monitor 1 (Display item selection) Sub Monitor 2 (Display item selection)	(Refer to K10.) (Refer to K10.)
--------------------	--	--

For details about sub monitor, refer to the description of Function code K10.

The monitor items of sub monitors 1 and 2 can be selected easily in Programming mode as follows.

PRG > 1(Start-up) > 4(Disp Setting) > 5(Sub Monitor 1)

PRG > 1(Start-up) > 4(Disp Setting) > 6(Sub Monitor 2)

For detailed setting procedure, refer to Chapter 5, Section 5.6.2.4 "Specifying the running status item to be monitored."

K20 K21 K22	Bar Chart 1 (Display item selection) Bar Chart 2 (Display item selection) Bar Chart 3 (Display item selection)
-------------------	---

These function codes specify the items to be displayed in bar graphs 1 to 3 on the LCD monitor.

- Data setting range: 1 to 26

Data for K20 to K22	Monitor item	Monitor name	LCD indicator	Unit	Meaning of displayed value
1	Output frequency 1 (before slip compensation)	Output frequency (synchronous)	Output fl	Hz	Reference frequency (Hz)
13	Output current	Output current	Output I	A	Current output from the inverter in RMS
14	Output voltage	Output voltage	Output V	V	Voltage output from the inverter in RMS
18	Calculated torque	Calculated torque	Torque	%	Motor output torque in % (Calculated value)
19	Input power	Input power	Consumption W	kW	Input power to the inverter
25	Load factor	Load factor	Load factor	%	Load factor of the motor in % as the rated output being at 100%
26	Motor output	Motor output	M output	kW	Motor output in kW

 The monitor items for bar charts 1 to 3 can be selected easily in Programming mode as follows.

PRG > 1(Start-up) > 4(Disp Setting) > 7(Bar Gage 1)

PRG > 1(Start-up) > 4(Disp Setting) > 8(Bar Gage 2)

PRG > 1(Start-up) > 4(Disp Setting) > 9(Bar Gage 3)

For detailed setting procedure, refer to Chapter 5, Section 5.6.2.4 "Specifying the running status item to be monitored."

K29**Display Filter**

K29 specifies a filter time constant to be applied for displaying the output frequency, output current and other running status on the LCD monitor of the keypad. If the display varies unstably so as to be hard to read due to load fluctuation or other causes, increase this filter time constant.

- Data setting range: 0.0 to 5.0 (s)



The display filter can be defined easily in Programming mode as follows.

PRG > 1(Start-up) > 4(Disp Setting) > 10(Disp Filter)

For detailed setting procedure, refer to Chapter 5, Section 5.6.2.4 "Specifying the running status item to be monitored."

K30**Coefficient for Speed Indication**

K30 specifies the coefficient that is used when the load shaft speed is displayed on the LCD monitor (see K10).

Load shaft speed (r/min) = (K30 Coefficient for speed indication) x (Frequency in Hz)

- Data setting range: 0.01 to 200.00



The coefficient can be specified easily in Programming mode as follows.

PRG > 1(Start-up) > 4(Disp Setting) > 11(Speed Coef)

For detailed setting procedure, refer to Chapter 5, Section 5.6.2.4 "Specifying the running status item to be monitored."

K31**Display Unit for Input Watt-hour Data**

K31 specifies the display unit for input watt-hour (K10 = 35) calculated by the inverter.

The data can be checked by accessing PRG > 3(INV Info) > 4(Maintenance) in Programming mode.

- Data setting range: 0, 1

Data for K31	Unit
0	kWh
1	MWh



The display unit can be specified easily in Programming mode as follows.

PRG > 1(Start-up) > 4(Disp Setting) > 12(WattHour Unit)

For detailed setting procedure, refer to Chapter 5, Section 5.6.2.4 "Specifying the running status item to be monitored."

K32**Display Coefficient for Input Watt-hour Data**

K32 specifies a display coefficient for displaying the input watt-hour data.

The data can be checked by accessing **PRG > 3(INV Info) > 4(Maintenance)** in Programming mode.

Input watt-hour data = Display coefficient (K32 data) x Input watt-hour (kWh)

- Data setting range: OFF (Cancel or reset), 0.001 to 9999.00

 **Note** Setting K32 data to OFF clears the input watt-hour and its data to "0." After clearing, be sure to restore the K32 data to the previous value; otherwise, input watt-hour data will not be accumulated.

 The display coefficient can be specified easily in Programming mode as follows.
PRG > 1(Start-up) > 4(Disp Setting) > 13(WattHour Coef)

For detailed setting procedure, refer to Chapter 5, Section 5.6.2.4 "Specifying the running status item to be monitored."

K33**Long-term, Input Watt-hour Data Monitor**

K33 selects the cumulative period for input watt-hour data calculated by the inverter from Hourly, Daily, Weekly and Monthly.

The inverter can save up to 48 sets of the cumulative data. If Monthly is selected, for example, it is possible to check a maximum of 48-month (4-year) input watt-hour data.

The data can be checked by accessing **PRG > 3(INV Info) > 4(Maintenance)** in Programming mode.

- Data setting range: OFF, 0 to 4

Data for K32	Cumulative period
OFF	Cancel and reset
1	Hourly
2	Daily
3	Weekly
4	Monthly

K81**Date Format**

K81 selects the date format to be displayed on the LCD monitor.

- Data setting range: 0 to 3

Data for K81	Date format
0	Y/M/D (year/month/day)
1	D/M/Y (day/month/year)
2	M/D/Y (month/day/year)
3	MD, Y (Month day, year)



The date format can be specified easily in Programming mode as follows.

PRG > 1(Start-up) > 3(Date/Time) > 3(Disp Format)

For detailed setting procedure, refer to Chapter 5, Section 5.6.2.3 "Setting the date/time."

K82**Time Format**

K82 selects the time format to be displayed on the LCD monitor.

- Data setting range: 0 to 2

Data for K82	Time Format
0	24-hour format (Time : Minute : Second)
1	12-hour format (Time : Minute : Second AM/PM)
2	12-hour format (AM/PM Time : Minute : Second)



The time format can be specified easily in Programming mode as follows.

PRG > 1(Start-up) > 3(Date/Time) > 3(Disp Format)

For detailed setting procedure, refer to Chapter 5, Section 5.6.2.3 "Setting the date/time."

K83**Daylight Saving Time (Summer time)**

K83 selects the correction time for daylight saving time (DST) to be displayed on the LCD monitor.

- Data setting range: 0 to 2

Data for K83	Correction time for daylight saving time
0	Disable
1	Enable (+ 1 hour)
2	Enable (+ 30 minutes)



The correction time can be specified easily in Programming mode as follows.

PRG > 1(Start-up) > 3(Date/Time) > 2(DST Setting)

For detailed setting procedure, refer to Chapter 5, Section 5.6.2.3 "Setting the date/time."

K84
K85

Daylight Saving Time (Start date)
Daylight Saving Time (End date)

K84 and K85 specify the start and end dates of daylight saving time (DST).

- Data setting range: 0000 to FFFF

Data for K84, K85	Start/end date
bit 0-1	Minute (in increments of 15 minutes, 0 to 45 minutes)
bit 2-4	Hour (in increments of 1 hour, 0 to 7 hours)
bit 5-7	Day/Day of the week
bit 8-10	Day/Week; Final week
bit 11-14	Month
bit 15	0: Month and day, 1: Day of the week



The start and end dates can be specified easily in Programming mode as follows.

PRG > 1(Start-up) > 3(Date/Time) > 2(DST Setting)

For detailed setting procedure, refer to Chapter 5, Section 5.6.2.3 "Setting the date/time."

K91
K92

Shortcut Key Function for ◀ in Running Mode
Shortcut Key Function for ▶ in Running Mode

These function codes define "jump-to" menus on the ◀ and ▶ keys as a shortcut key. Pressing the shortcut keys ◀ or ▶ in Running mode jumps the screen to the previously defined menu.

Assigning frequently-used menus to the shortcut keys allows a single touch of the shortcut key to open the target menu screen.

- Data setting range: 0 (Disable), 11 to 99

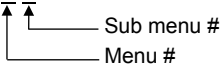
Example: Data 1 1

Data for K91, K92	Jump to:		Data for K91, K92	Jump to:	
	Menu	Sub menu		Menu	Sub menu
0	-- (Disable)	--	41	Alarm Info	Alarm History
11	Start-up	Language	42		Warn. History
12		App Select	43		Retry History
13		Date/Time	51	User Config	Select Q. Setup
14		Disp Setting	52		Password
21	Function Codes	Data Set	61	Tools	PID Monitor
22		Data Check	62		Multi-Op Mon
23		Changed Data	63		CLogic Monitor
24		Data Copy	64		Resonant Avd.
25		Timer Setup	65		Load Factor
26		Initialize	66		COM Debug
31	INV Info	Energy Monitor			
32		Op Monitor			
33		I/O Check			
34		Maintenance			
35		Unit Info			

 The shortcut functions for ◀ and ▶ can be defined easily in Programming mode as follows.

PRG >1(Start-up) > 4(Disp Setting) > 17(Shortcut "<")

PRG >1(Start-up) > 4(Disp Setting) > 18(Shortcut ">")

For detailed setting procedure, refer to Chapter 5, Section 5.6.2.4 "Specifying the running status item to be monitored."

Chapter 7

BLOCK DIAGRAMS FOR CONTROL LOGIC

This chapter provides the main block diagrams for the control logic of the FRENIC-HVAC series of inverters.

Contents

7.1	Symbols Used in Block Diagrams and their Meanings.....	7-1
7.2	Frequency Command Block.....	7-2
7.3	Drive Command Block	7-4
7.4	V/f Control Block	7-5
7.5	PID Process Control Block	7-7
7.6	External PID Process Control Block.....	7-9
7.7	FM1/FM2 Output Selector.....	7-11

FRENIC-HVAC series of inverters is equipped with a number of function codes to match a variety of motor operations required in your system. Refer to Chapter 6 "FUNCTION CODES" for details of the function codes.

The function codes have functional relationship each other. Several special function codes also work with execution priority each other depending on their functions or data settings.







This chapter explains the main block diagrams for control logic in the inverter. You are requested to fully understand the inverter's control logic together with the function codes in order to set the function code data correctly.

The block diagrams contained in this chapter show only function codes having mutual relationship. For the function codes that work independently and for detailed explanation of each function code, refer to Chapter 6 "FUNCTION CODES."

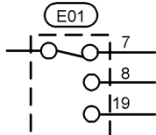
7.1 Symbols Used in Block Diagrams and their Meanings

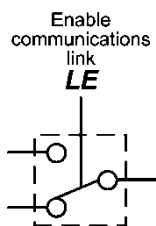
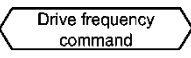
Table 7.1 lists symbols commonly used in block diagrams and their meanings with some examples.

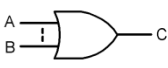
Table 7.1 Symbols and Meanings

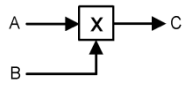
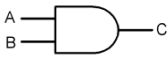
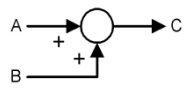
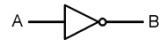
Symbol	Meaning	Symbol	Meaning
[FWD], [Y1] etc.	Programmable, digital inputs/outputs to/from the inverter's control circuit terminal block.		Function code.
FWD, REV etc.	Control signals (input) or status signals (output), assigned to control circuit terminals.		Switch controlled by a function code. Numbers assigned to the terminals express the function code data.
	Low-pass filter: Features appropriate characteristics by changing the time constant through the function code data.		Switch controlled by a terminal command. In the example shown on the left, the enable communications link command LE assigned to one of the digital input terminals from [X1] to [X7] controls the switch.
	Internal control signal for inverter logic.		High limiter: Limits the upper value by a constant or data set to a function code.
	Low limiter: Limits the lower value by a constant or data set to a function code.		OR logic: In normal logic, if any input is ON, then C = ON. Only if all inputs are OFF, then C = OFF.
	Zero limiter: Prevents data from dropping to a negative value.		NOR (Not-OR) logic: In normal logic, if any input is OFF, then C = ON. If all inputs are ON, C = OFF.
	Gain multiplier for reference frequencies given by current and/or voltage input or for analog output signals. $C = A \times B$		AND logic: In normal logic, only if A = ON and B = ON, then C = ON. Otherwise, C = OFF.
	Adder for 2 signals or values. $C = A + B$ If B is negative then $C = A - B$ (acting as a subtracter).		NOT logic: In normal logic, if A = ON, then B = OFF, and vice versa.

7.2 Frequency Command Block

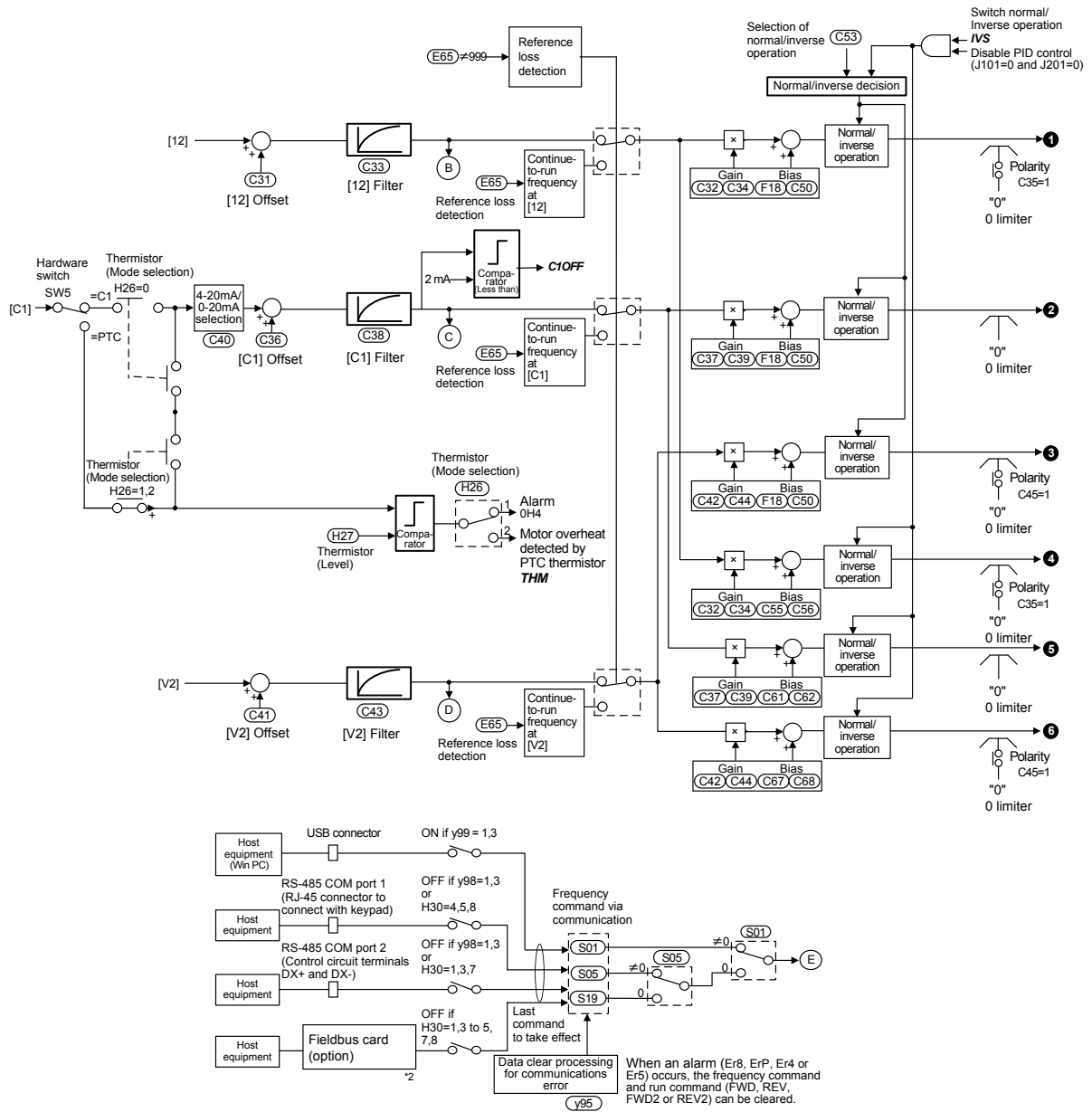

Figure 7.1 (1) Frequency Command Block

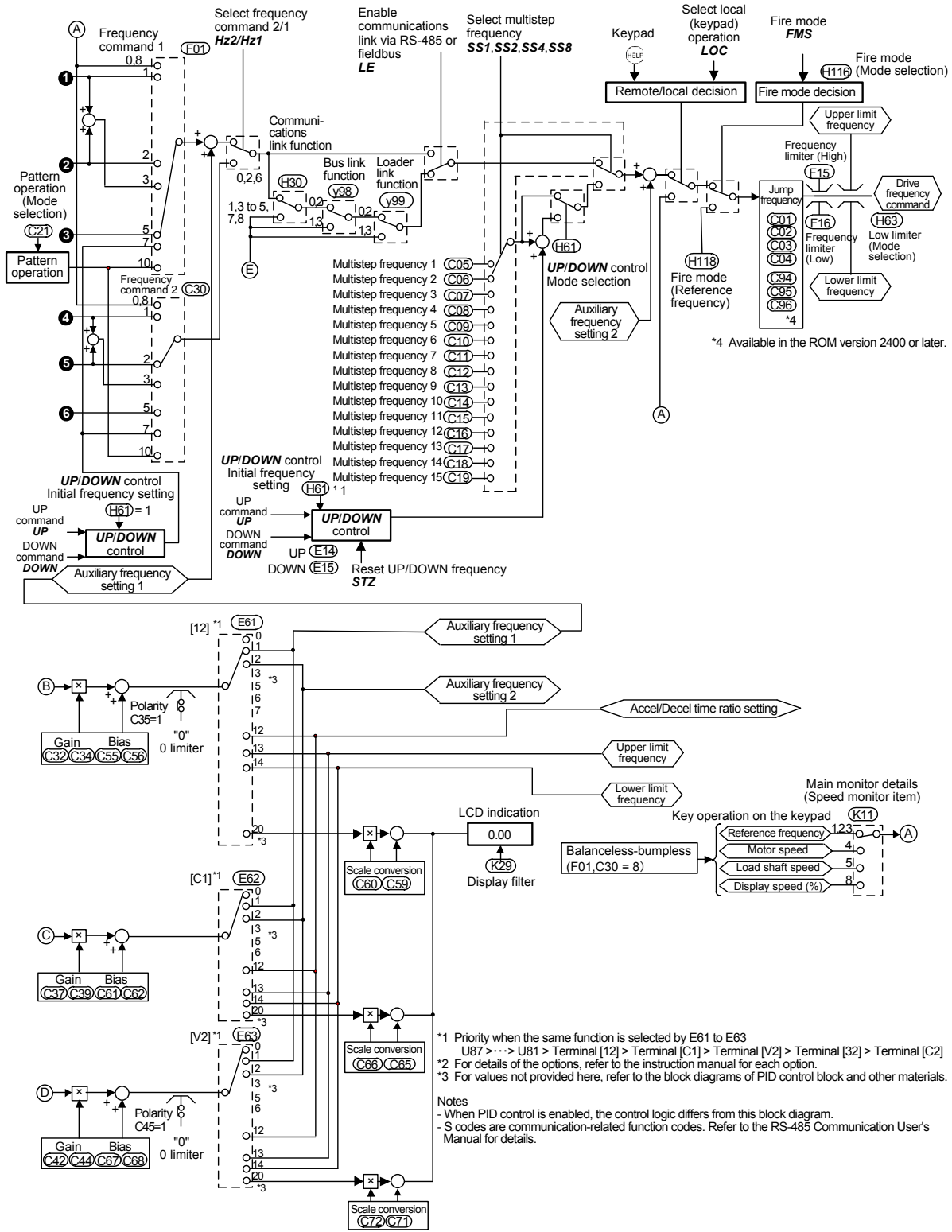

Figure 7.1 (2) Frequency Command Block

7.3 Drive Command Block

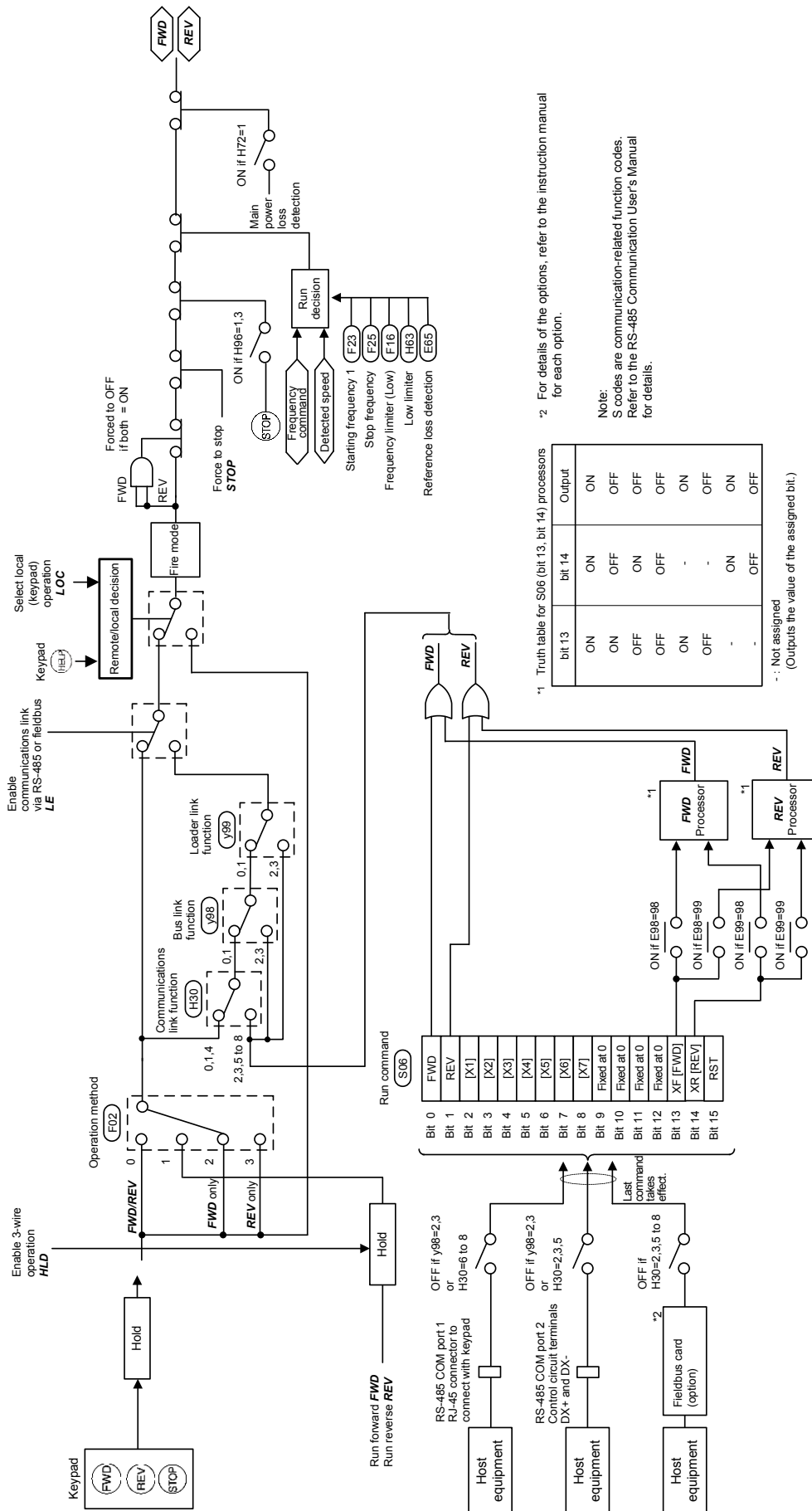

Figure 7.2 Drive Command Block

7.4 V/f Control Block

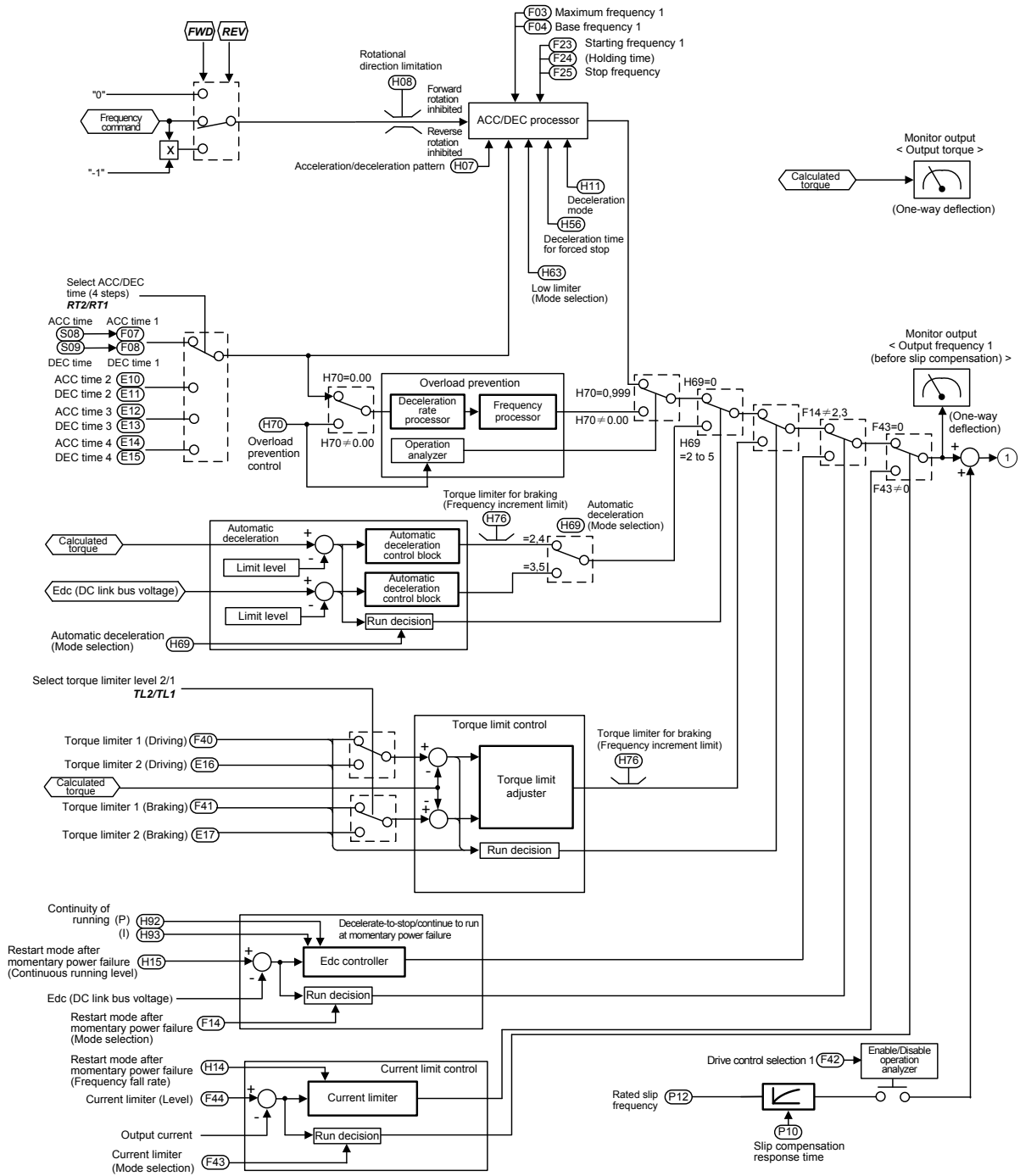

Figure 7.3 (1) V/f Control Block

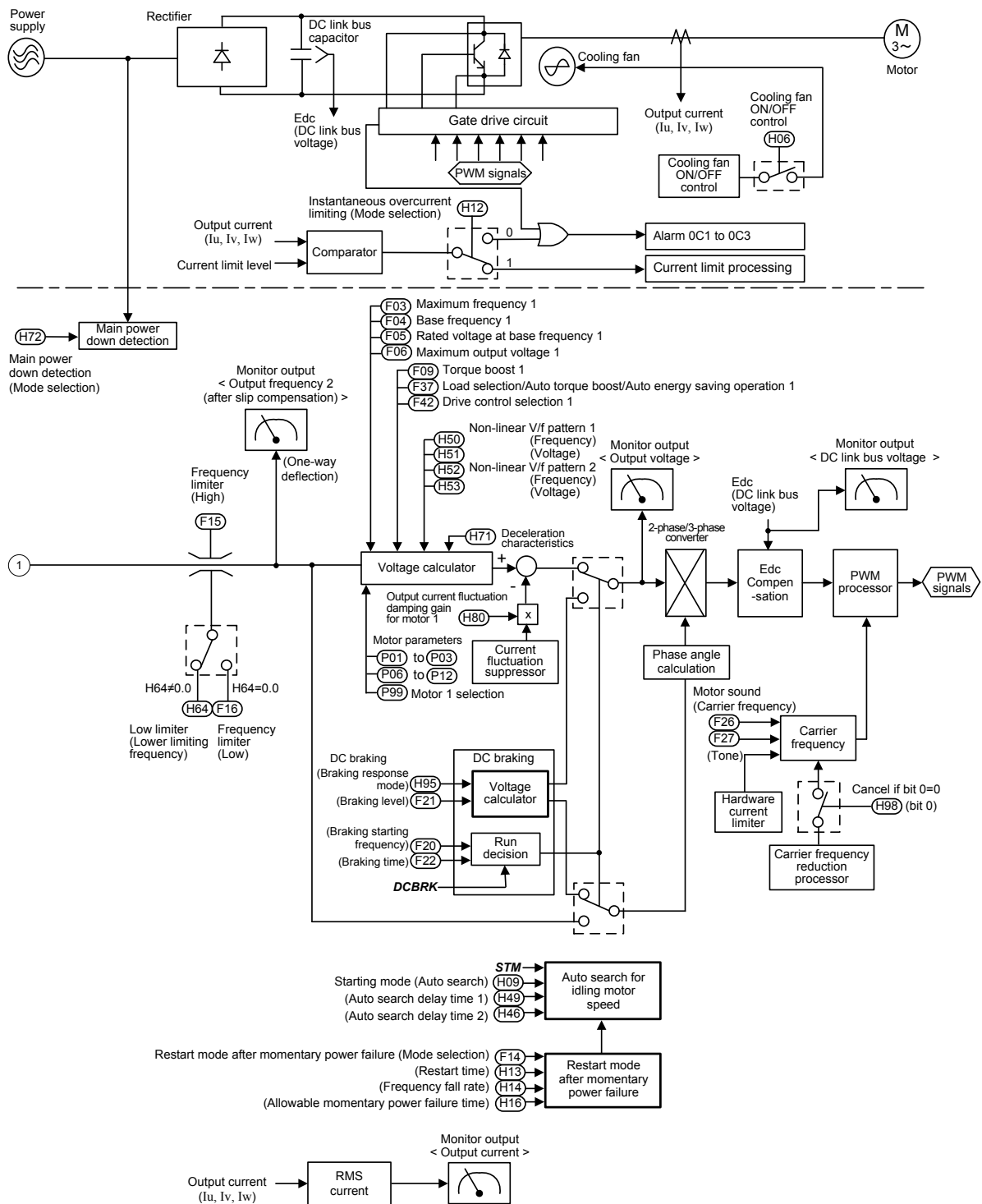

Figure 7.3 (2) V/f Control Block

7.5 PID Process Control Block

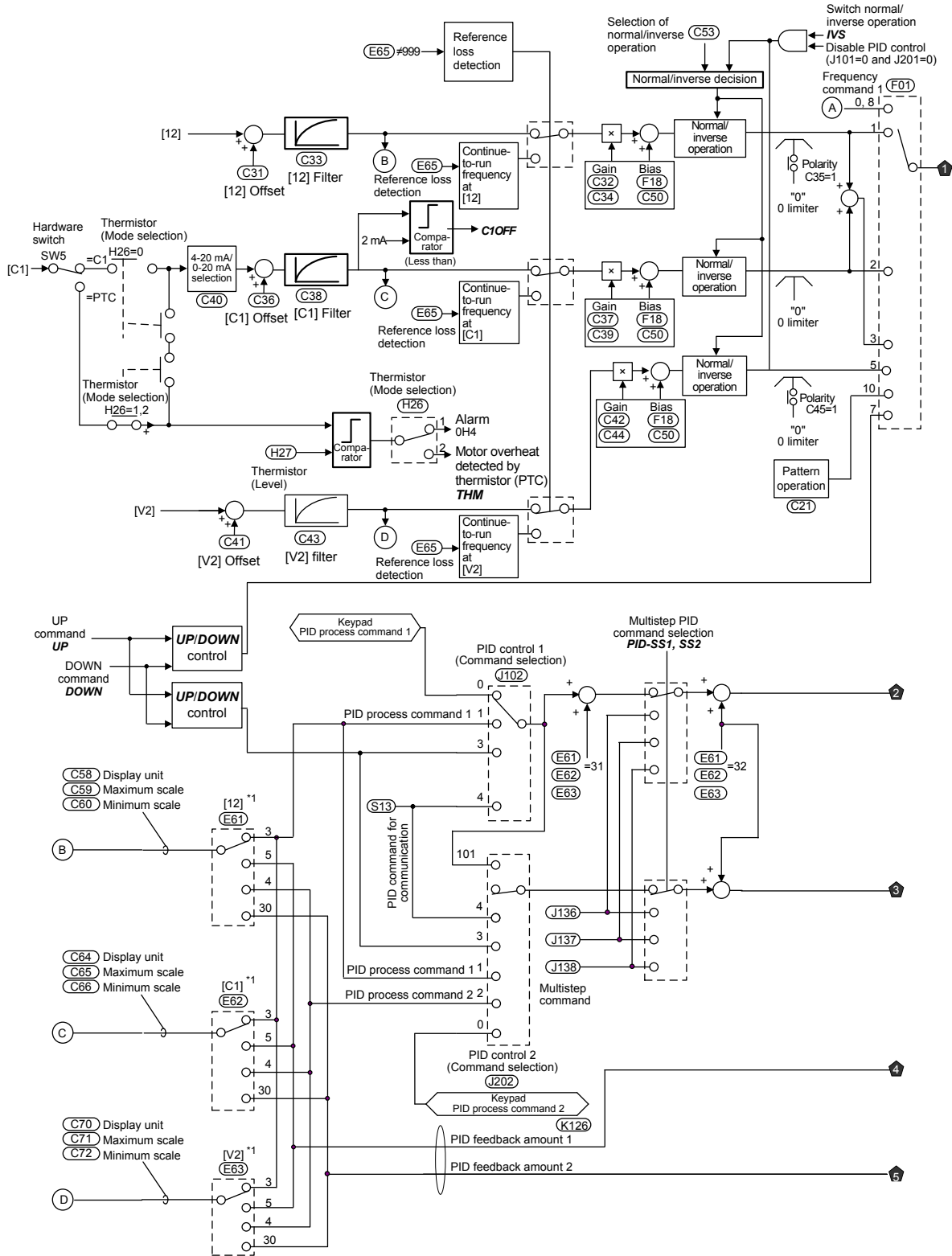
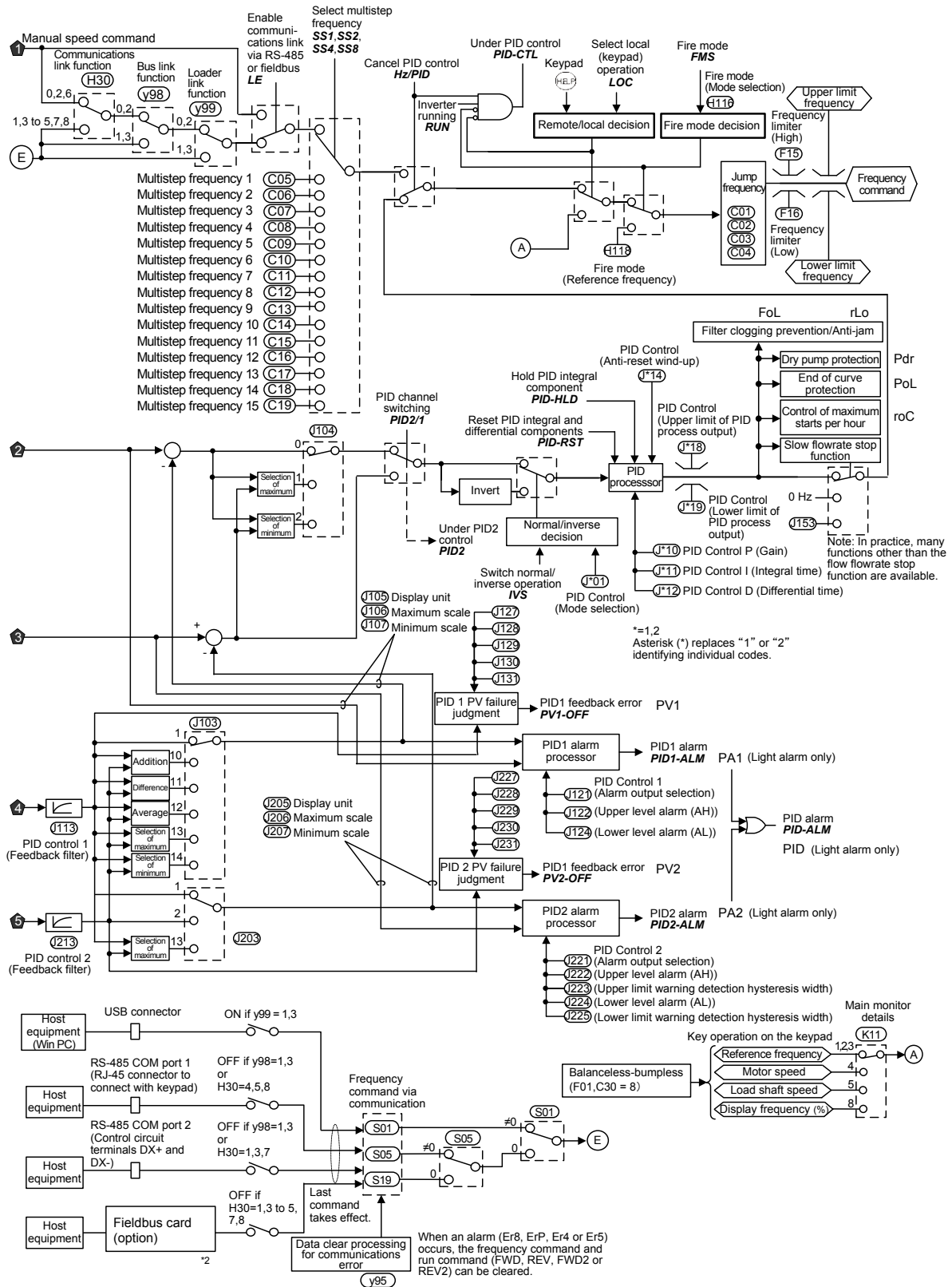

Figure 7.4 (1) PID Process Control Block



*1 Priority when the same function is selected by E61 to E63
 U87 > * > U81 > Terminal [12] > Terminal [C1] > Terminal [V2] > Terminal [32] > Terminal [C2] > Terminal [PT1] > Terminal [PT2]
 *2 For details of the options, refer to the instruction manual for each option.

Figure 7.4 (2) PID Process Control Block

7.6 External PID Process Control Block

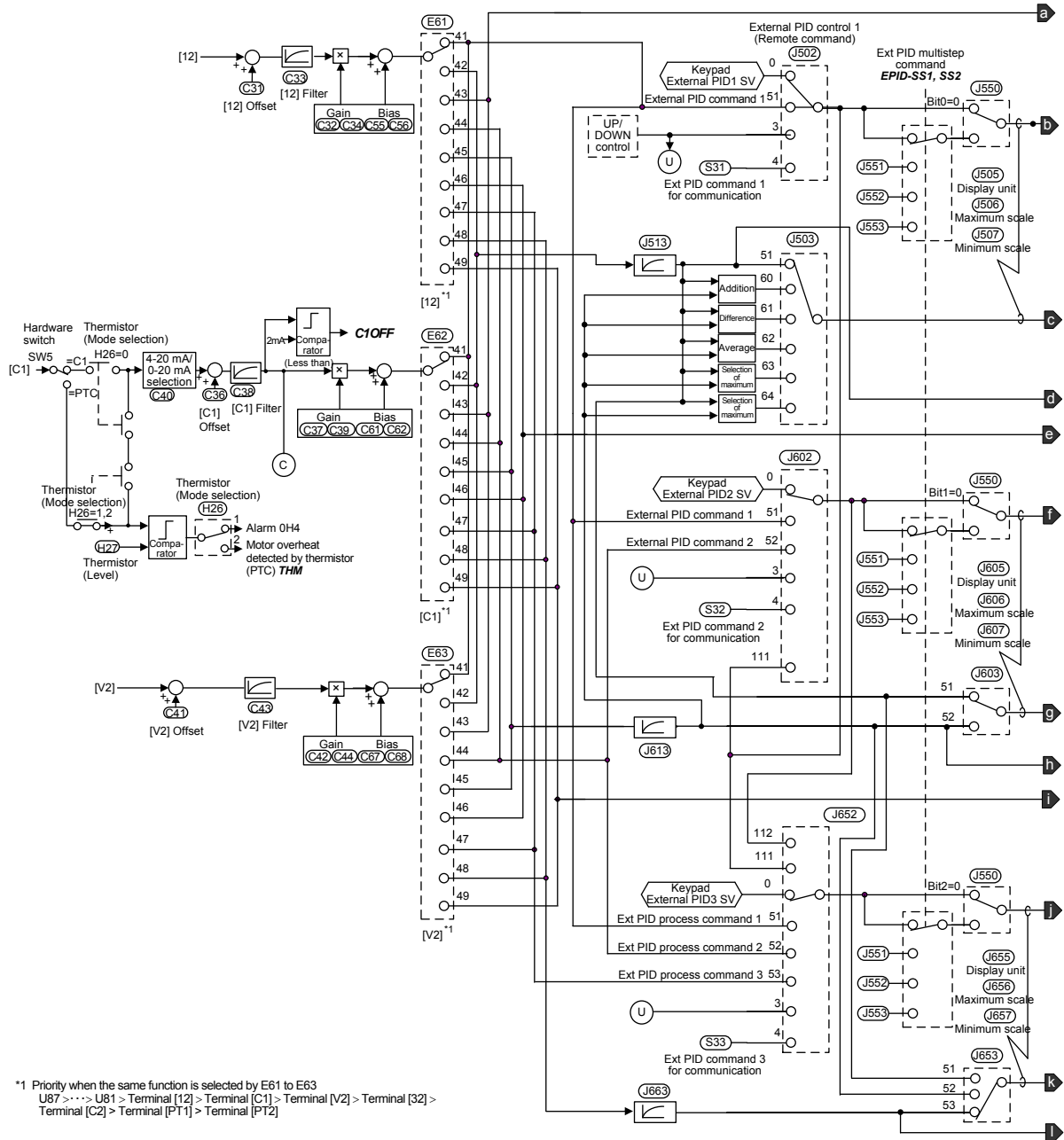

*1 Priority when the same function is selected by E61 to E63
 U87 > U81 > Terminal [12] > Terminal [C1] > Terminal [V2] > Terminal [32] >
 Terminal [C2] > Terminal [PT1] > Terminal [PT2]

Figure 7.5 (1) External PID Process Control Block

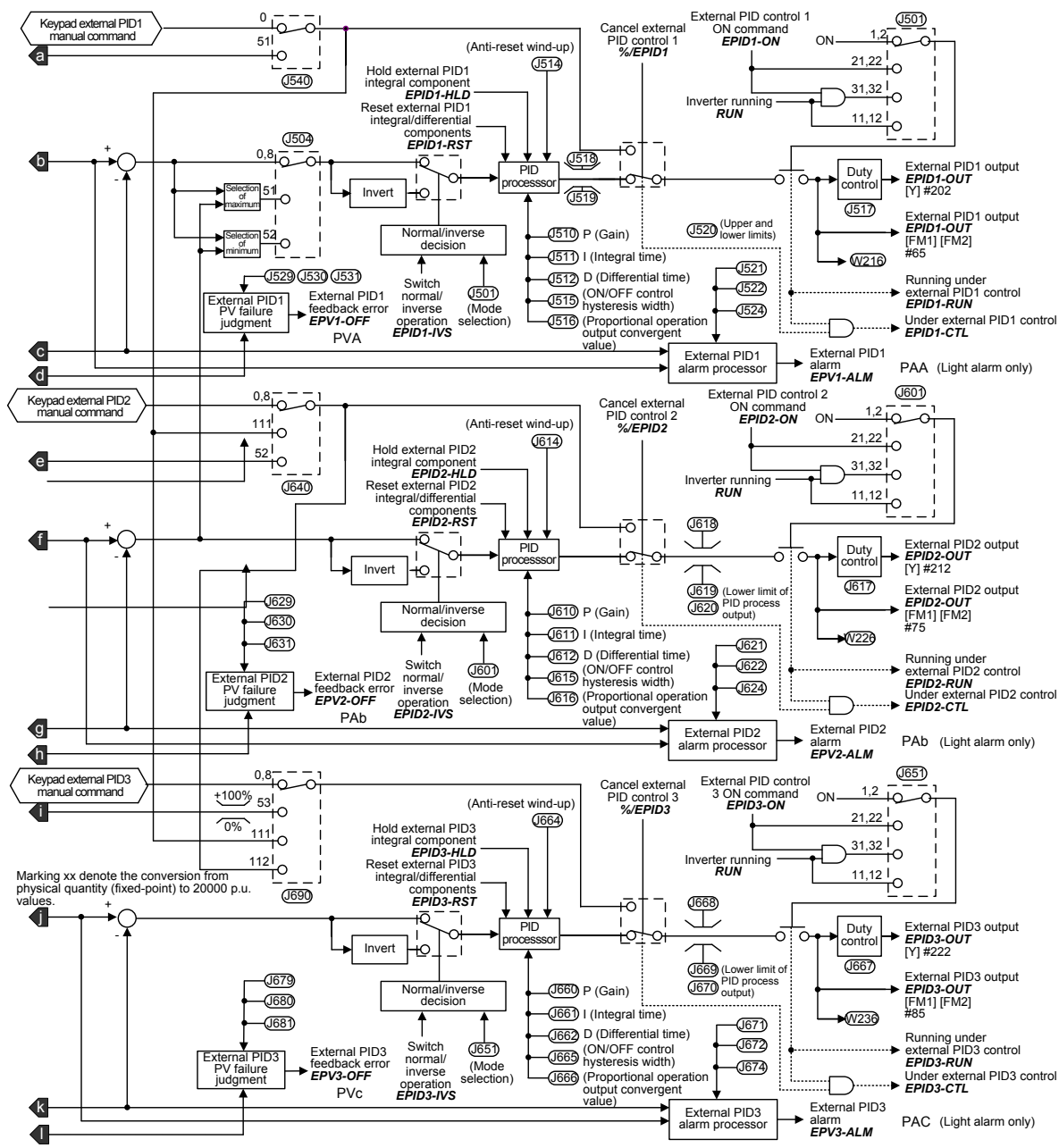

Figure 7.5 (2) External PID Process Control Block

7.7 FM1/FM2 Output Selector

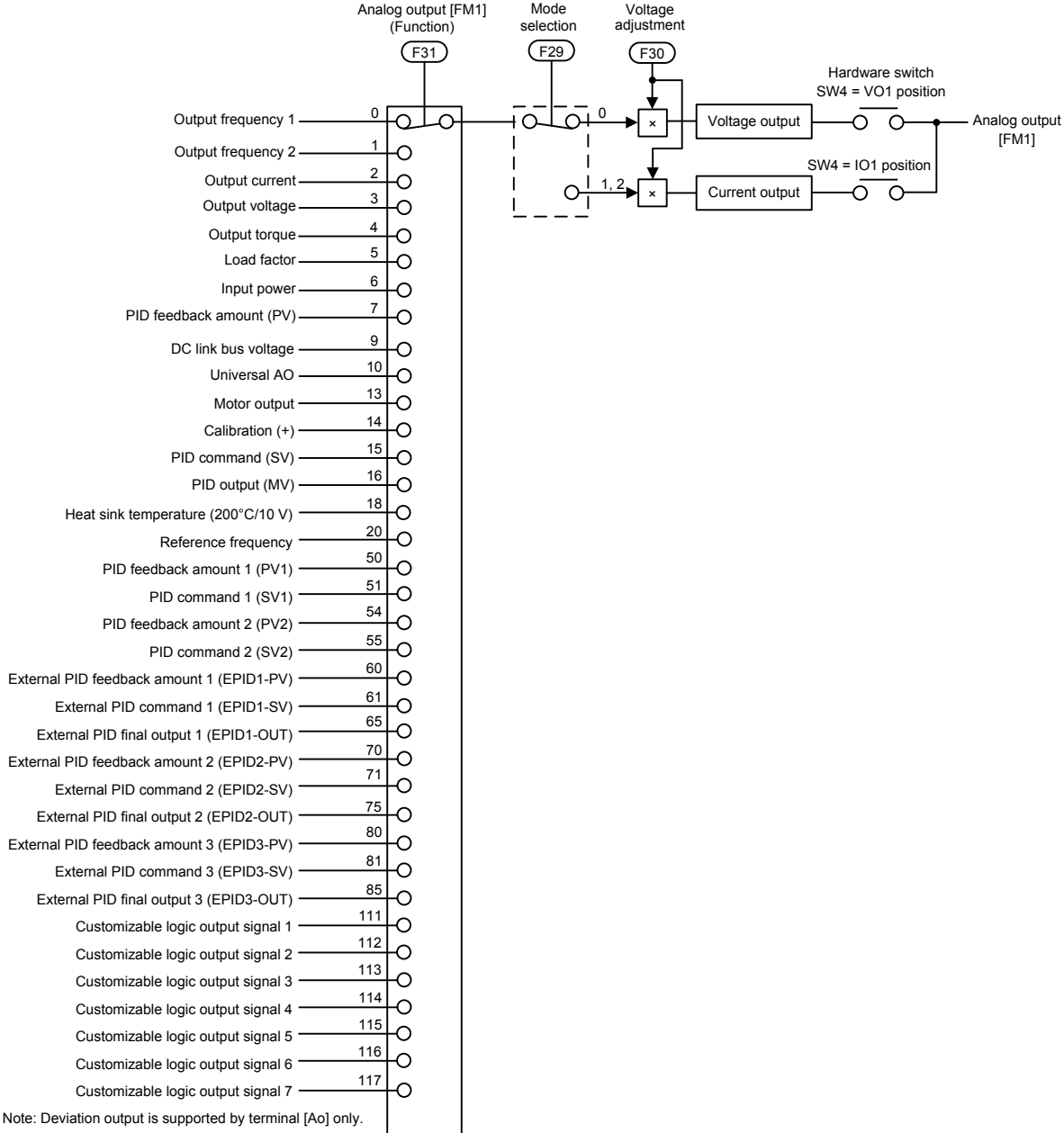

Figure 7.6 Terminal [FM1] Output Selector

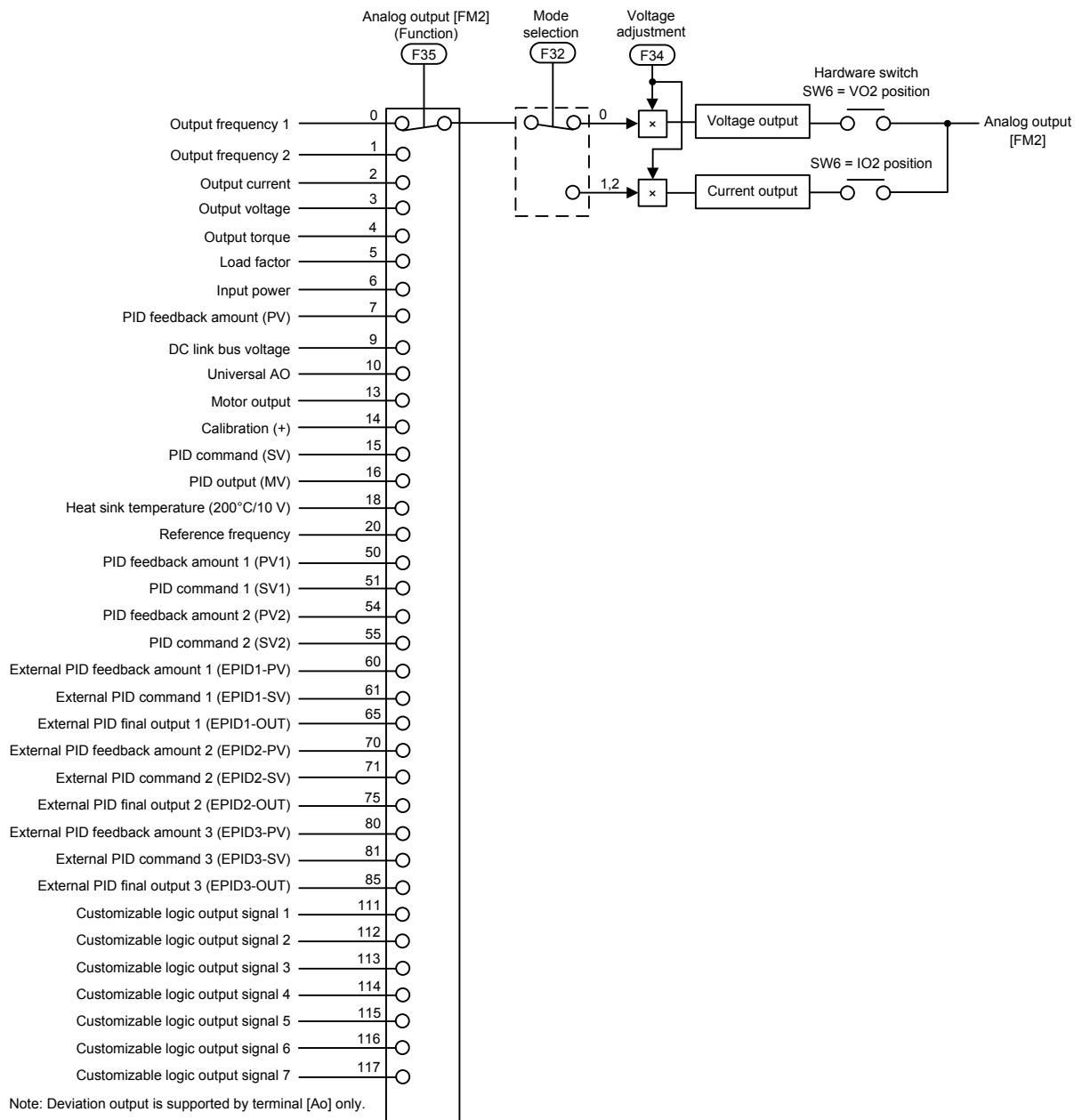

Figure 7.7 Terminal [FM2] Output Selector

Chapter 8

RUNNING THROUGH RS-485 COMMUNICATION

This chapter describes an overview of inverter operation through the RS-485 communications facility. Refer to the RS-485 Communication User's Manual for details.

Contents

8.1	Overview on RS-485 Communication	8-1
8.1.1	RS-485 common specifications.....	8-2
8.1.2	Terminal specifications for RS-485 communication.....	8-3
8.1.3	Connection method	8-4
8.1.4	Communications support devices.....	8-6
8.1.5	Noise suppression	8-7
8.2	Overview of FRENIC Loader	8-8
8.2.1	Specifications	8-8
8.2.2	USB port on the inverter unit.....	8-9

8.1 Overview on RS-485 Communication

The FRENIC-HVAC has two RS-485 communications ports at the locations shown below.

- (1) Communications port 1: RJ-45 connector for the keypad (modular jack)
- (2) Communications port 2: RS-485 terminals (Control circuit terminals SD, DX-, and DX+)

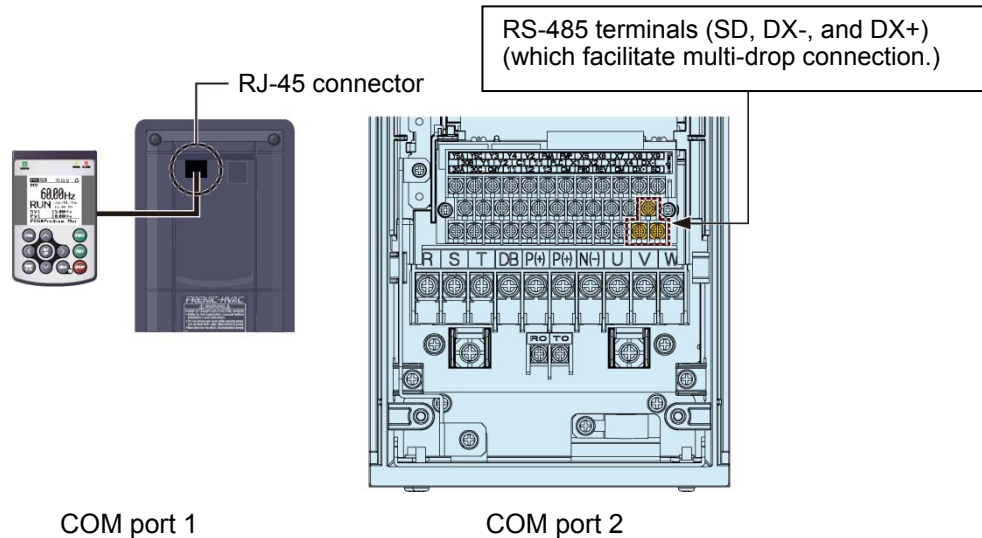

Using the RS-485 communications ports shown above enables the extended functions listed below.

■ Remote operation from a keypad at the remote location (COM port 1)

Using an extension cable to connect the standard keypad to the RJ-45 port allows you to mount the keypad on a panel located far from the inverter, enabling remote operation. The maximum length of the extension cable is 20 m.

■ Operation by FRENIC Loader (COM ports 1 and 2)

A Windows-based PC can be connected to the RJ-45 connector (RS-485 communication, COM port 1) or the USB port on the inverter. Through the interface, you can run FRENIC Loader (see Section 8.2) on the PC to edit the function code data and monitor the running status of the inverter. Connecting the PC to the RS-485 connector (COM port 2) on the terminal block also allows you to run FRENIC Loader.

■ Control via host equipment (COM ports 1 and 2)

Connecting the inverter to a PC, programmable logic controller (PLC), or other host equipment enables you to control the inverter as a subordinate device from the host.

Besides the communications port (RJ-45 connector) shared with the keypad, the FRENIC-HVAC has RS-485 terminals as standard. The connection via terminals facilitates multi-drop connection.

Protocols for managing a network including inverters include the Modbus RTU, Metasys N2, and BACnet that are widely used in FA markets, as well as the Fuji general-purpose inverter protocol that supports the FRENIC-HVAC and conventional series of inverters.

- Note**
- Connecting the keypad to the COM port 1 automatically switches to the keypad protocol; there is no need to modify the function code setting.
 - When using FRENIC Loader, which requires a special protocol for handling Loader commands, you need to set up some communications conditions accordingly. For details, refer to the FRENIC Loader Instruction Manual.
 - The COM port 2 supports only controls from host equipment, and not from the keypad.

 For details of RS-485 communication, refer to the RS-485 Communication User's Manual.

8.1.1 RS-485 common specifications

Items	Specifications				
Protocol	FGI-BUS	Modbus RTU	Loader commands	Metasys N2	BACnet
Compliance	Fuji general-purpose inverter protocol	Modicon Modbus RTU-compliant (only in RTU mode)	Dedicated protocol for FRENIC Loader (Not disclosed)	Johnson Controls Metasys N2 protocol	ASHRAE/ANSI/ISO-compliant
No. of supporting stations	Host device: 1 Inverters: Up to 31				
Electrical specifications	EIA RS-485				
Connection to RS-485	RJ-45 connector or terminal block				
Synchronization	Asynchronous start-stop system				
Transmission mode	Half-duplex				
Transmission speed	2400, 4800, 9600, 19200 or 38400 bps			9600 bps	9600, 19200, 38400 bps, 76800bps (*1)
Max. transmission cable length	500 m				
No. of logical station addresses available	1 to 31	1 to 247	0 to 255	0 to 255	0 to 127
Message frame format	FGI-BUS	Modbus RTU	FRENIC Loader	Metasys N2	MS/TP frame format
Frame synchronization	SOH (Start Of Header) character detection	Detection of no-data transmission time for 3-byte period	Header character detection (Start code 96H)	Header character detection (Start code 3EH)	Detection of two header characters (preamble) (0x55, 0xFF)
Frame length	Normal transmission: 16 bytes (fixed) High-speed transmission: 8 or 12 bytes	Variable length	Variable length	Variable length	Variable length
Max. transfer data	Write: 1 word Read: 1 word	Write: 50 words Read: 50 words	Write: 41 words Read: 41 words	Write: 1 word Read: 1 word	Write: 50 words Read: 50 words
Messaging system	Polling/Selecting/Broadcast		Command message	Polling/Selecting	Polling/Selecting/Broadcast
Transmission character format	ASCII	Binary	Binary	ASCII	Binary *Data of character string read: ASCII
Character length	8 or 7 bits (selectable by the function code)	8 bits (fixed)	8 bits (fixed)	8 bits (fixed)	8 bits (fixed)
Parity	Even, Odd, or None (selectable by the function code)		Even (fixed)	None	None
Stop bit length	1 or 2 bits (selectable by the function code)	No parity: 2 bits/1 bit Even or Odd parity: 1 bit Select by parity setting.	1 bit (fixed)	1 bit (fixed)	1 bit (fixed)
Error checking	Sum-check	CRC-16	Sum-check	Sum-check	Header CRC Data CRC

(*1) Available in the ROM version 2400 or later.

8.1.2 Terminal specifications for RS-485 communication

[1] RS-485 communications port 1 (for connecting the keypad)

The port designed for a standard keypad uses an RJ-45 connector having the following pin assignment:

Pin	Signal name	Function	Remarks
1 and 8	Vcc	Power source for the keypad	5 V power lines
2 and 7	GND	Reference potential	Grounding pins
3	N/A	Not available.	No connection
6	NC	Not used.	No connection
4	DX-	RS-485 data (-)	Built-in terminating resistor: 112Ω
5	DX+	RS-485 data (+)	Open/close by SW3*

* For details about SW3, refer to Chapter 2, Section 2.3.2 "Setting up the slide switches."

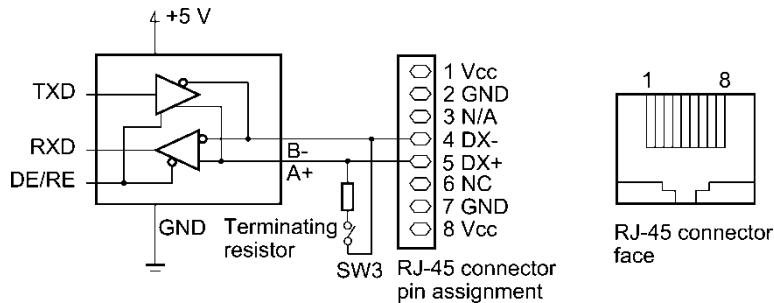

Note Pins 1, 2, 7, and 8 on the RJ-45 connector are exclusively assigned to power supply and grounding for keypads. When connecting other devices to the RJ-45 connector, take care not to use those pins. Failure to do so may cause a short-circuit hazard. Use pins 4 and 5 only.

[2] RS-485 communications port 2 (control circuit terminals)

The FRENIC-HVAC has terminals for RS-485 communications on the control circuit terminal block. The details of each terminal are shown below.

Signal name	Function	Remarks
SD	Shield terminal	
DX-	RS-485 data (-)	Built-in terminating resistor: 112Ω
DX+	RS-485 data (+)	Open/close by SW2*

* For details about SW2, refer to Chapter 2, Section 2.3.2 "Setting up the slide switches."

8.1.3 Connection method

- Up to 31 inverters can be connected to one host equipment.
- The protocol is commonly used in the FRENIC series of general-purpose inverters, so programs for similar host equipment can run/stop the inverter.
(The parameters specifications may differ depending on the equipment.)
- Fixed-length transmission frames facilitate developing communication control programs for hosts.

 For details of RS-485 communication, refer to the RS-485 Communication User's Manual.

Multi-drop connection using the RS-485 communications port 1 (for connecting the keypad)

For connecting inverters in multi-drop connection, use the branch adapters for multi-drop connection as shown below.

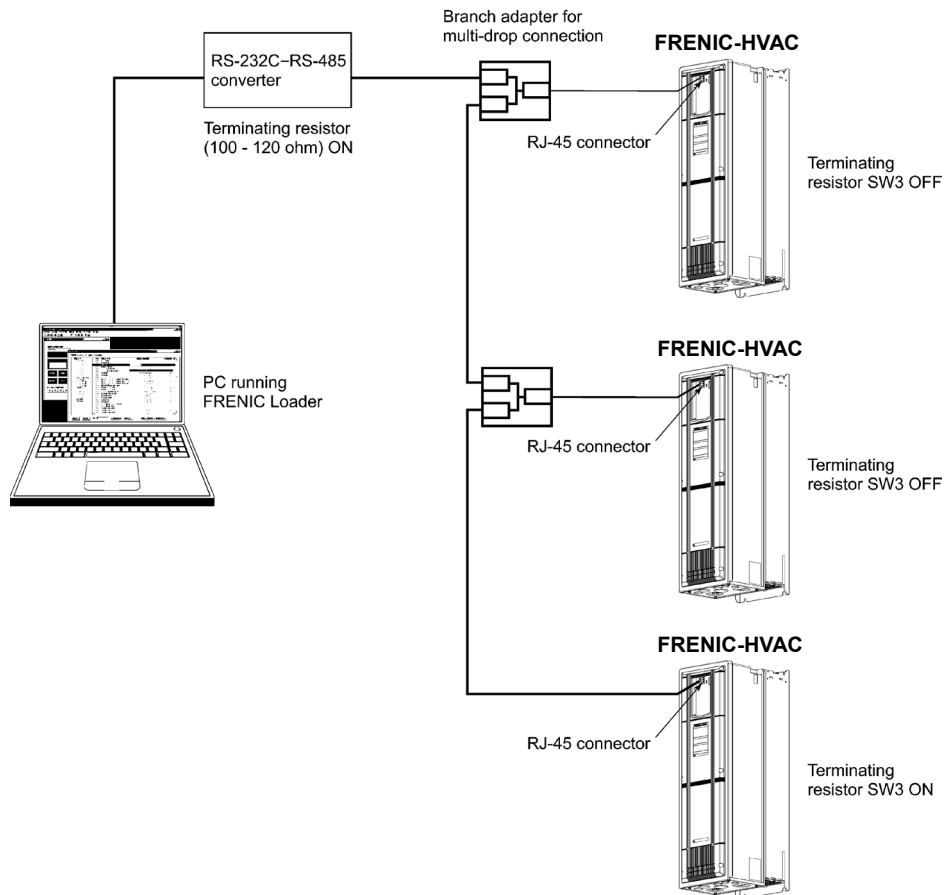



Figure 8.1 Multi-drop Connection (Using the RJ-45 connector)

-  **Note**
- Pins 1, 2, 7, and 8 on the RJ-45 connector are exclusively assigned to power supply and grounding for keypads. When connecting other devices to the RJ-45 connector, take care not to use those pins. Failure to do so may cause a short-circuit hazard. Use pins 4 and 5 only. (For details, refer to Section 8.1.2 "Terminal specifications for RS-485 communication.")
 - When selecting additional devices to prevent the damage or malfunction of the control PCB caused by external noises or eliminate the influence of common mode noises, be sure to refer to Section 8.1.4 "Communications support devices."
 - The maximum wiring length must be 500 m.
 - Use cables and converters meeting the specifications for proper connection. (Refer to [2] "Requirements for the cable (COM port 1: for RJ-45 connector)" in Section 8.1.4 "Communications support devices.")

Multi-drop connection using the RS-485 communications port 2 (on the terminal block)

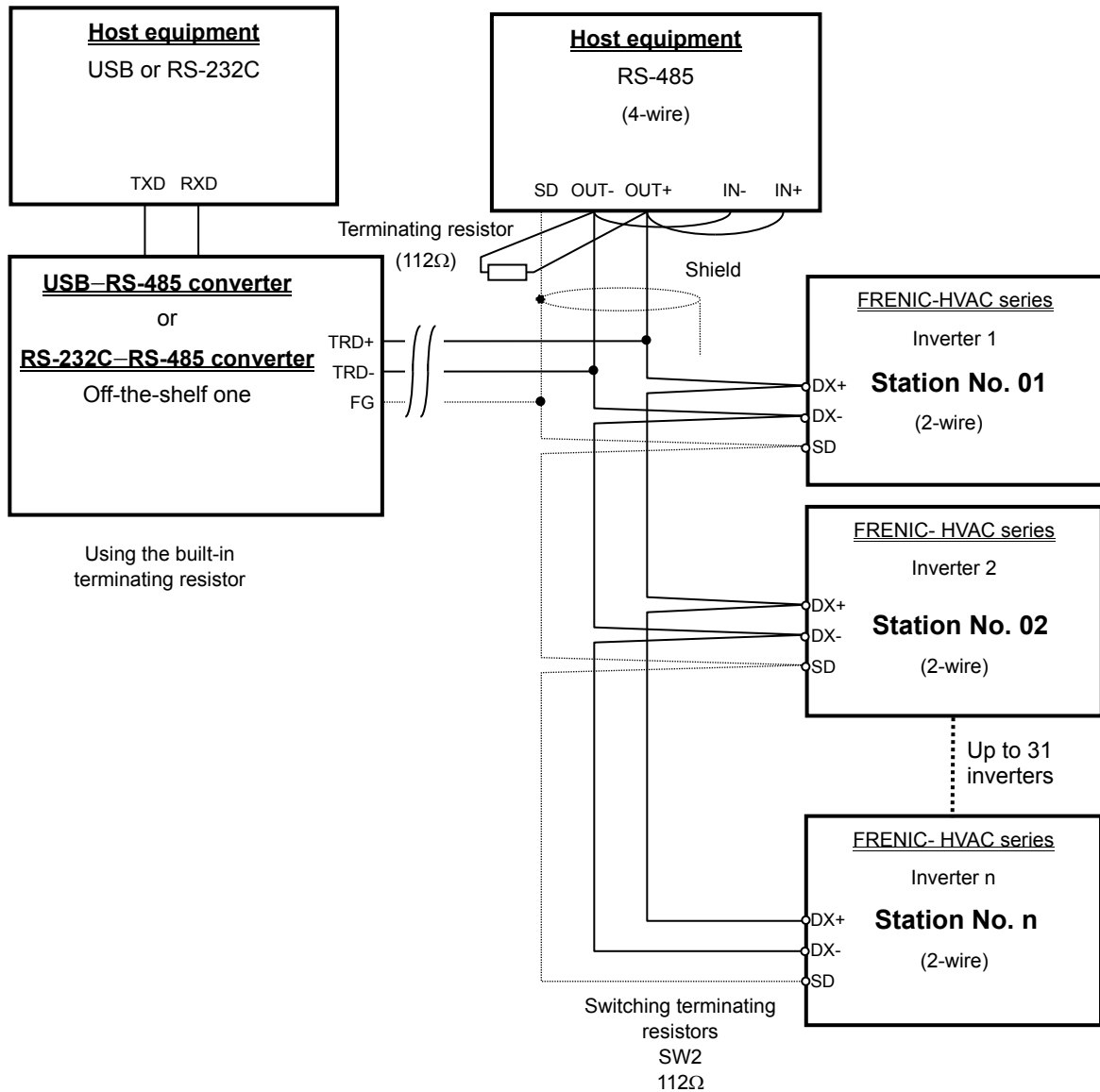

Figure 8.2 Multi-drop Connection Diagram (Connecting to the Terminal Block)

Note Use cables and converters meeting the specifications for proper connection. (Refer to [3] "Requirements for the cable (COM port 2: for RS-485 connector)" in Section 8.1.4 "Communications support devices.")

8.1.4 Communications support devices

This section describes the devices required for connecting the inverter to a PC having no RS-485 interface or for connecting two or more inverters in multi-drop network.

[1] Communications level converters

Usually PCs are not equipped with an RS-485 communications port but with an RS-232C port. To connect inverters to a PC, therefore, you need an RS-232C–RS-485 converter or a USB–RS-485 converter. To run the FRENIC-HVAC correctly, use a converter satisfying the requirements given below.

Requirements for recommended communications level converters

Send/receive switching:	Auto-switching by monitoring of send/receive data status at the PC (RS-232C)
Electric isolation:	Electrically isolated from the RS-485 port
Fail-safe:	Fail-safe facility*
Other requirements:	Superior noise immunity

* The fail-safe facility refers to a feature that ensures the RS-485 receiver's output at "High" (logical value = 0) even if the RS-485 receiver's input is opened or short-circuited or all the RS-485 drivers are inactive. Refer to Figure 8.3.

Recommended converters

System Sacom Sales Corporation (Japan) : KS-485PTI (RS-232C–RS-485 converter)
 : USB-485I RJ45-T4P (USB–RS-485 converter)

Send/receive switching system

The RS-485 communications system of the inverter acts in half-duplex mode (2-wire) so the converter must feature a send/receive switching circuitry. Generally, the switching system may be either one of the following.

- (1) Auto-switching by monitoring of send/receive data
- (2) Switching by RS-232C control signal of RTS or DTR (hardware flow control system)

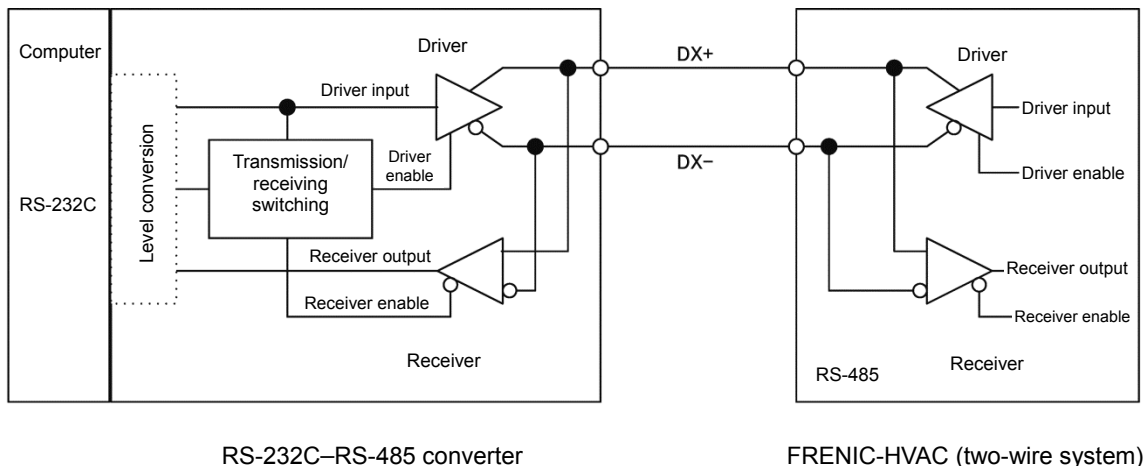

Figure 8.3 Communications Level Conversion

[2] Cable for RJ-45 connector (COM port 1)

Use a standard 10BASE-T/100BASE-TX LAN cable (US ANSI/TIA/EIA-568A category 5 compliant, straight type).

Note The RJ-45 connector (COM port 1) has power source pins (pins 1, 2, 7 and 8) exclusively assigned to keypads. When connecting other devices to the RJ-45 connector, take care not to use those pins. Using them will cause a short-circuit hazard. Use pins 4 and 5 only.

[3] Cable for RS-485 connector (COM port 2)

To ensure the reliability of connection, use twisted pair shield cables for long distance transmission AWG 16 to 26.

Recommended LAN cable

Manufacturer: FURUKAWA Electric Co., Ltd.

AWM2789 Cable for long distance connection

Type (Product code): DC23225-2PB

[4] Branch adapter for multi-drop

An RS-485 communications network for inverters utilizes 2-wire 10BASE-T LAN cables fitted with an RJ-45 connector at both ends. To connect those inverters to the network in multi-drop mode, use branch adapters for multi-drop.

Recommended branch adapter

SK Koki (Japan): MS8-BA-JJJ

8.1.5 Noise suppression

Depending on the operating environment, instruments may malfunction due to the noise generated by the inverter. Possible measures to prevent such malfunction are: separating the wiring, use of shielded cable, isolating the power supply, and adding an inductance component. Shown below is an example of adding an inductance component.

 Refer to the RS-485 Communication User's Manual, Chapter 2, Section 2.2.4 "Noise suppression" for details.

Adding inductance components

To suppress or eliminate noise for keeping the network in high noise immunity level, insert inductance components such as choke coils in series in the signal circuit, or pass the RS-485 communications cable through a ferrite core ring or wind it around by 2 or 3 turns as shown below to keep the impedance of the signal lines high.

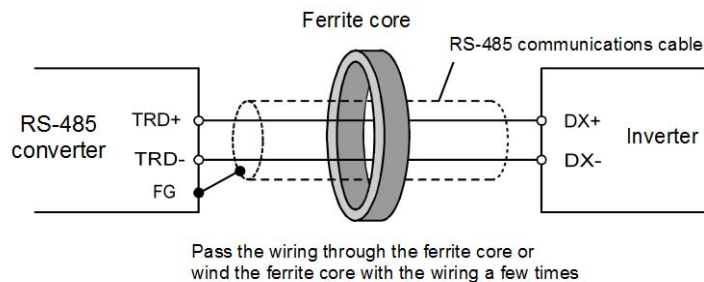

Figure 8.4 Adding an Inductance Component

8.2 Overview of FRENIC Loader

FRENIC Loader is a software tool that supports the operation of the inverter via an RS-485 communications link. It allows you to remotely run or stop the inverter, edit, set, or manage the function codes, monitor key parameters and values during operation, as well as monitor the running status (including alarm information) of the inverters on the RS-485 communications network.

 **Note** With special order-made inverters, FRENIC Loader may not be able to display some function codes normally.

 For details, refer to the FRENIC Loader Instruction Manual.

8.2.1 Specifications

Item	Specifications (White on black indicates factory default)	Remarks	
Name of software	FRENIC Loader		
Supported inverter	FRENIC-HVAC/AQUA	(Note 1)	
No. of supported inverters	When connected to USB port: 1 When connected to RS-485 communications ports: Up to 31		
Recommended cable	10BASE-T cable with RJ-45 connectors compliant with EIA568	For the RS-485 interface	
Operating environment	CPU	Intel Pentium III 600 MHz or later (Note 2)	
	OS	Microsoft Windows XP Microsoft Vista (32-bit) Microsoft 7 (32-bit)	
	Memory	512 MB or more RAM	1 GB or more recommended
	Hard disk	20 MB or more free space	
	COM port	RS-232C (conversion to RS-485 communication required to connect inverters) or USB	
	Monitor	XGA (1024 x 768), 32-bit color or higher is recommended	
Transmission requirements	COM port	COM1 to COM255	PC COM ports assigned to Loader
	Transmission rate	When connected to USB port: Between loader and USB = fixed at 12 (Mbps) When connected to RS-485 communications ports: 38400, 19200, 9600, 4800, 2400 (bps)	19200 bps or more is recommended. (Note 3)
	Character length	8 bits	Prefixed
	Stop bit length	1 bit	Prefixed
	Parity	Even	Prefixed
	No. of retries	None, 1 to 10	No. of retry times before detecting communications error
	Timeout setting	(100 ms, 300 ms, 500 ms), (1.0 to 1.5 to 1.9 s), (2.0 to 9.0 s) or (10.0 to 60.0 s)	This setting should be longer than the response interval time specified by function code y09 of the inverter.

(Note 1) FRENIC Loader cannot be used with inverters that do not support SX protocol (protocol for handling Loader commands).

(Note 2) Use a PC with as high a performance as possible, since some slow PCs may not properly refresh the operation status monitor or test-run windows.

8.2.2 USB port on the inverter unit

The USB port on the inverter unit allows you to connect a computer supporting USB connection and use FRENIC Loader. As described below, various information of the inverter can be monitored and controlled on the computer.

Features

1. The inverter can be directly connected to the computer through a commercial USB cable (mini B) without using a converter. The computer can be connected online with the inverter.
 2. With FRENIC Loader, the inverter can support the following functions (1) to (5).
 - (1) Editing, comparing, and copying the function code data
 - (2) Real-time operation monitor
 - (3) Alarm history (latest and last 9 alarms)
 - (4) Maintenance information
 - (5) Historical trace
- Data can be transferred from the USB port on the inverter unit directly to the computer (FRENIC Loader) in the manufacturing site.
 - Periodical collection of life information can be carried out efficiently.
 - The real-time tracing function permits the operator to check the equipment for abnormality.

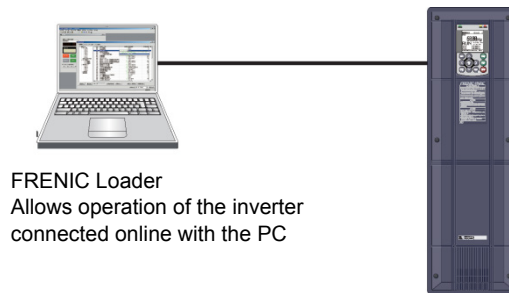

The USB port (CN10*) is located on the upper right of the control printed circuit board (control PCB) as shown below. To connect the USB cable to CN10, remove the front cover so that you can see the control PCB.

*miniB connector, Version 2.0 compliant

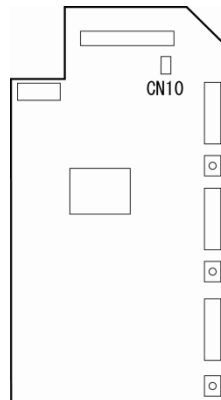

Figure 8.5 Location of USB Connector on Control PCB

Chapter 9

TROUBLESHOOTING

This chapter describes troubleshooting procedures to be followed when the inverter malfunctions or detects an alarm or a light alarm condition. First check whether an alarm code or "light alarm" indication is displayed, and then proceed to the respective troubleshooting item.

Contents

9.1	Protective Functions.....	9-1
9.2	Before Proceeding with Troubleshooting.....	9-2
9.3	If an Alarm Code Appears on the Monitor.....	9-3
9.3.1	Alarm Codes	9-3
9.3.2	If the "Light Alarm" Indication Appears	9-22
9.4	Nothing appears on the monitor.....	9-24
9.4.1	Abnormal motor operation.....	9-24
9.4.2	Problems with inverter settings.....	9-31
9.5	If Other than an Alarm Code is Displayed.....	9-33

9.1 Protective Functions

The FRENIC-HVAC/AQUA series of inverters has various protective functions as listed below to prevent the system from going down and reduce system downtime. The protective functions marked with ● in the table are disabled by factory default. Enable them according to your needs.

The protective functions include, for example, the "heavy alarm" detection function which, upon detection of an abnormal state, displays the alarm code on the LCD monitor and causes the inverter to trip, the "light alarm" detection function which displays the alarm code but lets the inverter continue the current operation, and other warning signal output functions.

If any problem arises, understand the content of the protective functions listed below and follow the procedures given in Sections 9.2 and onwards for troubleshooting.

Protective function	Description	Related function code
"Heavy alarm" detection	This function detects an abnormal state, displays the corresponding alarm code, and causes the inverter to trip. The "heavy alarm" codes are check-marked in the "Heavy alarm" object column in Table 9.1. For details of each alarm code, see the corresponding item in the troubleshooting. The inverter can store and display the last ten alarm codes and the date on which they occurred (when realtime clock function enabled), and detailed information on each relevant part for the past four alarms.	H98
● "Light alarm" detection	This function detects abnormal states, and allows operation to continue without tripping the inverter while displaying and outputting warnings. It is possible to define which abnormal states should be categorized as a "light alarm". See the "light alarm" codes in Table 9.1. See Section 9.3.2 for details on how to check and release light alarms.	H181 H182 H183 H184
Stall prevention	When the output current exceeds the current limiter level (F44) during acceleration/ deceleration or constant speed running, this function decreases the output frequency and controls increases in output current to avoid an overcurrent trip.	F44
● Overload prevention control	Before the inverter trips due to a heat sink overheat (OH1) or inverter overload (OLU), this function decreases the output frequency to reduce the load.	H70
● Automatic deceleration (Anti-regenerative control)	If regenerative energy returned exceeds the inverter's braking capability, this function automatically increases the deceleration time or controls the output frequency to avoid an overvoltage trip.	H69 H76
● Deceleration characteristics (Excessive regenerative energy proof braking capability)	During deceleration, this function increases the motor energy loss and decreases the regenerative energy returned to avoid an overvoltage trip (OV).	H71
● Reference loss detection	This function detects a reference frequency loss (due to a broken wire, etc.), continues the inverter operation at the previously specified frequency, and issues the "Command loss detected" signal REF OFF .	E65
Automatic lowering of carrier frequency	Before the inverter trips due to an abnormal ambient temperature or output current, this function automatically lowers the carrier frequency to mitigate inverter loss and avoid a trip.	H98
● Dew condensation prevention	Even when the inverter is in stopped state, this function feeds DC current across the motor at certain intervals to raise the motor temperature and prevent dew condensation.	J21
Motor overload early warning	When the inverter output current reaches the specified level, this function issues the "Motor overload early warning" signal OL before the thermal overload protection function causes the inverter to trip for motor protection.	E34 E35
● Auto-reset	When the inverter has stopped because of a trip, this function allows the inverter to automatically reset alarms and restart itself. (The number of retries and the latency between stop and reset can be specified.)	H04 H05
● Forced stop	Upon receipt of the forced stop command STOP , this function interrupts the run and other commands currently applied in order to forcedly decelerate the inverter to a stop.	H56
Surge protection	This function protects the inverter from a surge voltage invaded between main circuit power lines and the ground.	--

9.2 Before Proceeding with Troubleshooting

WARNING

If any of the protective functions has been activated, first remove the cause. Then, after checking that the all run commands are set to OFF, release the alarm. If the alarm is released while any run commands are set to ON, the inverter may supply the power to the motor, running the motor.

Injury may occur.

- Even though the inverter has interrupted power to the motor, if the voltage is applied to the main circuit input terminals L1/R, L2/S and L3/T, voltage may be output to inverter output terminals U, V, and W.
- Turn OFF the power, and after at least ten minutes have elapsed, use a multimeter or similar instrument to ensure that the DC link bus voltage between the terminals P (+) and N (-) has dropped to a safe level (+25 VDC or below).

Electric shock may occur.

Follow the procedure below to solve problems.

- (1) Is the inverter correctly wired?
Refer to Chapter 2, Section 2.10 "Connection Diagram".
- (2) Is an alarm code displayed on the LCD monitor?
 - If alarm code displayed Go to Section 9.3.
 - Abnormal motor operation Go to Section 9.4.1.
 - Problems with inverter settings Go to Section 9.4.2.
 - If Other than an Alarm Code is Displayed Go to Section 9.5.

If any problems persist after the above recovery procedure, contact your Fuji Electric representative.

9.3 If an Alarm Code Appears on the Monitor

9.3.1 Alarm Codes

Table 9.1 Abnormal States Detectable ("Heavy Alarm" and "Light Alarm" Objects)

Code	Name	"Heavy alarm" objects	Retry registration objects	"Light alarm" objects	Remarks	Ref. page
OC1, OC2, OC3	Instantaneous overcurrent	√	√	--		9-5
EF	Earth fault	√	--	--	FRN030AR1■-2U or above FRN060AR1■-4U or above	9-5
OV1, OV2, OV3	Overvoltage	√	√	--		9-6
LV	Undervoltage	√	√	--		9-6
LiN	Input phase loss	√	--	--		9-7
OPL	Output phase loss	√	--	--		9-8
OH1	Heat sink overheat	√	√	--		9-8
OH2	External alarm	√	√	√		9-9
OH3	Inverter internal overheat	√	√	√		9-9
OH4	Motor protection (PTC thermistor)	√	√	--		9-9
FUS	Fuse blown	√	--	--	FRN125AR1S-2U FRN150AR1S-4U or above	9-10
PbF	Charger circuit fault	√	--	--	FRN030AR1■-2U or above FRN060AR1■-4U or above	9-10
OL1	Overload of motors 1	√	√	√		9-11
OLU	Inverter overload	√	√	--		9-11
Er1	Memory error	√	--	--		9-12
Er2	Keypad communications error	√	--	--		9-12
Er3	CPU error	√	--	--		9-13
Er4	Option communications error	√	--	√		9-13
Er5	Option error	√	--	√		9-13
Er6	Operation protection	√	--	--		9-13
Er7	Tuning error	√	--	--		9-14
Er8 ErP	RS-485 communications error (COM port 1) RS-485 communications error (COM port 2)	√	--	√		9-15
ErF	Data saving error during undervoltage	√	--	--		9-16
ErH	Hardware error	√	--	--		9-16
CoF	Power input disconnect detection	√	--	√		9-16
ECL	Customizable logic error	√	--	--		9-17
ECF	Enable circuit error	√	--	--		9-17
PV1, PV2	PID control 1, 2 feedback error detection	√	--	√		9-17
PVA, PVb, PVC	External PID control 1, 2, 3 feedback error detection	√	--	√		9-18
Pdr	Drought protection	√	--	√	Not supported by the FRENIC-HVAC.	9-18
roC	Control of maximum starts per hour	√	--	√		9-19
PoL	End of curve protection	√	--	√		9-19
rLo	Anti jam	√	--	--		9-20
FoL	Filter clogging error	√	--	√		9-20

Table 9.1 Abnormal States Detectable ("Heavy Alarm" and "Light Alarm" Objects) (continued)

Code	Name	"Heavy alarm" objects	Retry registration objects	"Light alarm" objects	Remarks	Ref. page
LoK	Password protection	√	--	--		9-21
Err	Mock alarm	√	--	--		9-21
FAL	DC fan locked	--	--	√	FRN075AR1S-2U to FRN125AR1S-2U FRN030AR1M-2U to FRN060AR1M-2U FRN007AR1L-2U to FRN060AR1L-2U FRN150AR1S-4U to FRN1000AR1S-4U FRN060AR1M-4U to FRN150AR1M-4U FRN015AR1L-4U to FRN125AR1L-4U FRN150AR1S-5U to FRN300AR1S-5U FRN060AR1M-5U to FRN150AR1M-5U FRN015AR1L-5U to FRN150AR1L-5U	--
OL	Motor overload early warning	--	--	√		--
OH	Heat sink overheat early warning	--	--	√		--
LIF	Lifetime alarm	--	--	√		--
rEF	Reference command loss detected	--	--	√		--
UTL	Low torque output	--	--	√		--
PTC	PTC thermistor activated	--	--	√		--
rTE	Inverter life (Cumulative motor run time)	--	--	√		--
CnT	Inverter life (Number of startups)	--	--	√		--
PA1, PA2	PID control 1, 2 warning output	--	--	√		--
PAA, PAb, PAC	External PID control 1, 2, 3 warning output	--	--	√		--
SLA	Mutual operation slave inverter alarm	--	--	√	Not supported by the FRENIC-HVAC.	--
Lob	Low battery	--	--	√		9-21
dtL	Data information loss	--	--	√		9-21
Fod	Forced operation	--	--	--		--

[1] OCn Instantaneous overcurrent

Problem The inverter momentary output current exceeded the overcurrent level.

OC1 Overcurrent occurred during acceleration.

OC2 Overcurrent occurred during deceleration.

OC3 Overcurrent occurred during running at a constant speed.

Possible Causes	What to Check and Suggested Measures
(1) The inverter output lines were short-circuited.	Disconnect the wiring from the inverter output terminals ([U], [V] and [W]) and measure the interphase resistance of the motor wiring. Check if the resistance is too low. ➔ Remove the short-circuited part (including replacement of the wires, relay terminals and motor).
(2) Ground faults have occurred at the inverter output lines.	Disconnect the wiring from the output terminals ([U], [V] and [W]) and perform a Megger test. ➔ Remove the grounded parts (including replacement of the wires, relay terminals and motor).
(3) Overload.	Measure the motor current with a measuring device to trace the current trend. Then, use this data to judge if the trend is over the calculated load value for your system design. ➔ If the load is too heavy, reduce it or increase the inverter capacity. Trace the current trend and check if there are any sudden changes in the current. ➔ If there are any sudden changes, make the load fluctuation smaller or increase the inverter capacity. ➔ Enable instantaneous overcurrent limiting (H12 = 1).
(4) Excessive torque boost specified. (when F37 = 0, 1, 3, or 4)	Check whether decreasing the torque boost (F09) decreases the output current but does not stall the motor. ➔ If no stall occurs, decrease the torque boost (F09).
(5) The acceleration/ deceleration time was too short.	Check that the motor generates enough torque required during acceleration/deceleration. That torque is calculated from the moment of inertia for the load and the acceleration/deceleration time. ➔ Increase the acceleration/deceleration time (F07, F08, E10 through E15, and H56). ➔ Enable the current limiter (F43) and torque limiter (F40, F41, E16, and E17). ➔ Increase the inverter capacity.
(6) Malfunction caused by noise.	Check if noise control measures are appropriate (e.g., correct grounding and routing of control and main circuit wires). ➔ Implement noise control measures. For details, refer to Appendix A. ➔ Enable the Auto-reset (H04). ➔ Connect a surge absorber to magnetic contactor's coils or other solenoids (if any) causing noise.

[2] EF Earth fault

Problem An earth fault current flowed from the output terminal of the inverter.

Possible Causes	What to Check and Suggested Measures
(1) An earth fault occurred at the inverter output terminal(s).	Disconnect the wiring from the output terminals ([U], [V], and [W]) and perform a Megger test. ➔ Remove the earthed parts (including replacement of the wires, relay terminals and motor).

[3] OVn Overvoltage

Problem The DC link bus voltage was over the detection level of overvoltage.

OV1 Overvoltage occurred during acceleration.

OV2 Overvoltage occurred during deceleration.

OV3 Overvoltage occurred during running at constant speed.

Possible Causes	What to Check and Suggested Measures
(1) The power supply voltage exceeded the inverter's specification range.	Measure the input voltage. → Decrease the voltage to within the specified range.
(2) A surge current entered the input power supply.	In the same power line, if a phase-advancing capacitor is turned ON/OFF or a thyristor converter is activated, a surge (momentary large increase in the voltage or current) may be caused in the input power. → Install an AC reactor.
(3) The deceleration time was too short for the moment of inertia for load.	Recalculate the deceleration torque based on the moment of inertia for the load and the deceleration time. → Increase the deceleration time (F08, E11, E13, E15, and H56). → Enable the automatic deceleration (anti-regenerative control) (H69), or deceleration characteristics (H71). → Enable torque limiter (F40, F41, E16, E17, and H73). → Set the rated voltage (at base frequency) (F05) to "0" to improve the braking capability.
(4) The acceleration time was too short.	Check if the overvoltage alarm occurs after rapid acceleration. → Increase the acceleration time (F07, E10, E12, and E14). → Select the S-curve pattern (H07).
(5) Braking load was too heavy.	Compare the braking torque of the load with that of the inverter. → Set the rated voltage (at base frequency) (F05) to "0" to improve the braking capability.
(6) Malfunction caused by noise.	Check if the DC link bus voltage was below the protective level when the overvoltage alarm occurred. → Implement noise control measures. For details, refer to Appendix A. → Enable the auto-reset (H04). → Connect a surge absorber to magnetic contactor's coils or other solenoids (if any) causing noise.
(7) Excessive high-frequency current from outside (Occurred during stoppage after turning ON main power.)	Prevent the inflow of high-frequency current. → Apply control measures at the high-frequency current side. → In some instances, this can be improved by removing the E1 and E2 screws. In this case, the EMC filter will no longer function, and the inverter will no longer conform to EMC standards. Please contact Fuji Electric if these screws are removed.

[4] LV Undervoltage

Problem DC link bus voltage has dropped below the undervoltage detection level.

Possible Causes	What to Check and Suggested Measures
(1) A momentary power failure occurred.	→ Release the alarm. → If you want to restart running the motor without treating this condition as an alarm, set F14 to "3," "4," or "5," depending on the load type.
(2) The power to the inverter was switched back to ON too soon (when F14 = 1).	Check if the power to the inverter was switched back to ON while the control power was still alive. (Check whether the LEDs on the keypad light.) → Turn the power ON again after all LEDs on the keypad go off.

Possible Causes	What to Check and Suggested Measures
(3) The power supply voltage did not reach the inverter's specification range.	Measure the input voltage. ➔ Increase the voltage to within the specified range.
(4) Peripheral equipment for the power circuit malfunctioned, or the connection was incorrect.	Measure the input voltage to find which peripheral equipment malfunctioned or which connection is incorrect. ➔ Replace any faulty peripheral equipment, or correct any incorrect connections.
(5) Any other loads connected to the same power supply have required a large starting current, causing a temporary voltage drop.	Measure the input voltage and check the voltage fluctuation. ➔ Reconsider the power supply system configuration.
(6) Inverter's inrush current caused the power voltage drop because the power supply transformer capacity was insufficient.	Check if the alarm occurs when a molded case circuit breaker (MCCB), residual-current-operated protective device (RCD)/earth leakage circuit breaker (ELCB) (with overcurrent protection) or magnetic contactor (MC) is turned ON. ➔ Reconsider the capacity of the power supply transformer.

[5] Lin Input phase loss

Problem Input phase loss occurred, or interphase voltage unbalance rate was large.

Possible Causes	What to Check and Suggested Measures
(1) Breaks in wiring to the main power input terminals.	Measure the input voltage. ➔ Repair or replace the main circuit power input wires or input devices (MCCB, MC, etc.).
(2) The screws on the main power input terminals are loosely tightened.	Check if the screws on the main power input terminals have become loose. ➔ Tighten the terminal screws to the recommended torque.
(3) Interphase voltage unbalance between three phases was too large.	Measure the input voltage. ➔ Connect an AC reactor (ACR) to lower the voltage unbalance between input phases. ➔ Increase the inverter capacity.
(4) Overload cyclically occurred.	Measure the ripple wave of the DC link bus voltage. ➔ If the ripple is large, increase the inverter capacity.
(5) Single-phase voltage was input to the three-phase input inverter.	Check the inverter type. ➔ Apply three-phase power. The FRENIC-HVAC/AQUA of three-phase input cannot be driven by single-phase power.

 The input phase loss protection can be disabled with the function code H98 (Protection/Maintenance Function).

[6] OPL Output phase loss

Problem Output phase loss occurred.

Possible Causes	What to Check and Suggested Measures
(1) Inverter output wires are broken.	Measure the output current. ➔ Replace the output wires.
(2) The motor winding is broken.	Measure the output current. ➔ Replace the motor.
(3) The terminal screws for inverter output were not tight enough.	Check if any screws on the inverter output terminals have become loose. ➔ Tighten the terminal screws to the recommended torque.
(4) A single-phase motor has been connected.	➔ Single-phase motors cannot be used. Note that the FRENIC-HVAC/AQUA only drives three-phase induction motors.

[7] OH1 Heat sink overheat

Problem Temperature around heat sink has risen abnormally.

Possible Causes	What to Check and Suggested Measures
(1) Temperature around the inverter exceeded the inverter's specification range.	Measure the temperature around the inverter. ➔ Lower the temperature around the inverter (e.g., ventilate the panel where the inverter is mounted).
(2) Ventilation path is blocked.	Check if there is sufficient clearance around the inverter. ➔ Change the mounting place to ensure the clearance.
	Check if the heat sink is not clogged. ➔ Clean the heat sink.
(3) Cooling fan's airflow volume decreased due to the service life expired or failure.	Check the cumulative run time of the cooling fan. (See Chapter 5, Section "5.6.4.4 Viewing Maintenance Information".) ➔ Replace the cooling fan.
	Visually check whether the cooling fan rotates normally. ➔ Replace the cooling fan.
(4) Overload.	Measure the output current. ➔ Reduce the load (e.g. Use the heat sink overheat early warning (E20 through E27) or the overload early warning (E34) and reduce the load before the overload protection is activated.). ➔ Decrease the motor sound (carrier frequency) (F26). ➔ Enable the overload prevention control (H70).

[8] OH2 External alarm

Problem External alarm was inputted (*THR*).
(when the "Enable external alarm trip" *THR* has been assigned to any of digital input terminals)

Possible Causes	What to Check and Suggested Measures
(1) An alarm function of external equipment was activated.	Check the operation of external equipment. ➔ Remove the cause of the alarm that occurred.
(2) Wrong connection or poor contact in external alarm signal wiring.	Check if the external alarm signal wiring is correctly connected to the terminal to which the "Enable external alarm trip" terminal command <i>THR</i> has been assigned (Any of E01 through E07, E98, and E99 should be set to "9"). ➔ Connect the external alarm signal wire correctly.
(3) Incorrect setting of function code data.	Check whether the "Enable external alarm trip" terminal command <i>THR</i> has been assigned to an unavailable terminal (with E01 through E07, E98, or E99). ➔ Correct the assignment.
	Check whether the normal/negative logic of the external signal matches that of the <i>THR</i> command specified by any of E01 through E07, E98, and E99. ➔ Ensure the matching of the normal/negative logic.

[9] OH3 Inverter internal overheat

Problem Temperature inside the inverter has exceeded the allowable limit.

Possible Causes	What to Check and Suggested Measures
(1) The ambient temperature exceeded the inverter's specification limit.	Measure the ambient temperature. ➔ Lower the temperature around the inverter (e.g., ventilate the panel where the inverter is mounted).
(2) The airflow generated by the internal fan has dropped because the fan lifetime has been reached or because a fault has occurred.	Visually check whether the internal fan is functioning normally. ➔ Replace the internal fan.
(3) The power is turned ON too often	Reduce the number of times the power is turned ON/OFF (guide: 1/hour or less)

[10] OH4 Motor protection (PTC thermistor)

Problem Temperature of the motor has risen abnormally.

Possible Causes	What to Check and Suggested Measures
(1) The temperature around the motor exceeded the motor's specification range.	Measure the temperature around the motor. ➔ Lower the temperature.
(2) Cooling system for the motor defective.	Check if the cooling system of the motor is operating normally. ➔ Repair or replace the cooling system of the motor.
(3) Overload.	Measure the output current. ➔ Reduce the load (e.g. Use the heat sink overheat early warning (E01 through E09) or the overload early warning (E34) and reduce the load before the overload protection is activated.). (In winter, the load tends to increase.)
	➔ Lower the temperature around the motor.

Possible Causes	What to Check and Suggested Measures
(4) The activation level (H27) of the PTC thermistor for motor overheat protection was set inadequately.	Check the PTC thermistor specifications and recalculate the detection voltage. → Modify the data of function code H27.
(5) Settings for the PTC thermistor are improper.	Check the setting of the thermistor mode selection (H26) and the slider position of the terminal [C1] property switch SW5. → Change the H26 data in accordance with the thermistor used and set the SW5 to the PTC position.
(6) Excessive torque boost specified. (F09)	Check whether decreasing the torque boost (F09) does not stall the motor. → If no stall occurs, decrease the F09 data.
(7) The V/f pattern did not match the motor.	Check if the base frequency (F04) and the rated voltage at base frequency (F05) match the values on the motor's nameplate. → Match the function code data with the values on the motor's nameplate.
(8) Incorrect setting of function code data.	Although no PTC thermistor is used, the thermistor mode is enabled (H26). → Set the H26 data to "0" (Disable).

[11] FUS Fuse blown

Problem The fuse inside the inverter blew.

Possible Causes	What to Check and Suggested Measures
(1) The fuse blew due to short-circuiting inside the inverter.	Check whether there has been any excess surge or noise coming from outside. → Take measures against surges and noise. → Have the inverter repaired.

[12] PbF Charger circuit fault

Problem The magnetic contactor for short-circuiting the charging resistor failed to work.

Possible Causes	What to Check and Suggested Measures
(1) The control power was not supplied to the magnetic contactor intended for short-circuiting the charging resistor.	<p>Check that, in normal connection of the main circuit (not a connection via the DC link bus), the connector (CN R) on the power printed circuit board (power PCB) is not inserted to [NC]. → Insert the connector (CN R) to [FAN].</p> <p>Check whether you quickly turned the circuit breaker ON and OFF to confirm safety after cabling/wiring. → Wait until the DC link bus voltage has dropped to a sufficiently low level and then release the current alarm. After that, turn ON the power again. (Do not turn the circuit breaker ON and OFF quickly.) (Turning ON the circuit breaker supplies power to the control circuit to the operation level (lighting the LEDs on the keypad) in a short period. Immediately turning it OFF even retains the control circuit power for a time, while it shuts down the power to the magnetic contactor intended for short-circuiting the charging resistor since the contactor is directly powered from the main power. Under such conditions, the control circuit can issue a turn-on command to the magnetic contactor, but the contactor not powered can produce nothing. This state is regarded as abnormal, causing an alarm.)</p>

[13] OL1 Overload of motor 1

Problem Electronic thermal protection for motor activated.

Possible Causes	What to Check and Suggested Measures
(1) The electronic thermal characteristics do not match the motor overload characteristics.	Check the motor characteristics. → Reconsider the data of function codes (P99, F10 and F12). → Use an external thermal relay.
(2) Activation level for the electronic thermal protection was inadequate.	Check the continuous allowable current of the motor. → Reconsider and change the data of function code F11.
(3) The specified acceleration/ deceleration time was too short.	Recalculate the acceleration/deceleration torque and time needed for the load, based on the moment of inertia for the load and the acceleration/deceleration time. → Increase the acceleration/ deceleration time (F07, F08, E10 through E15, and H56).
(4) Overload.	Measure the output current. → Reduce the load (e.g. Use the overload early warning (E34) and reduce the load before the overload protection is activated.). (In winter, the load tends to increase.)
(5) Excessive torque boost specified (F09)	Check whether decreasing the torque boost (F09) does not stall the motor. → If no stall occurs, decrease the F09 data.

[14] OLU Inverter overload



Problem Temperature inside inverter has risen abnormally.

Possible Causes	What to Check and Suggested Measures
(1) Temperature around the inverter exceeded the inverter's specification range.	Measure the temperature around the inverter. → Lower the temperature (e.g., ventilate the panel where the inverter is mounted).
(2) Excessive torque boost specified (F09)	Check whether decreasing the torque boost (F09) does not stall the motor. → If no stall occurs, decrease the F09 data.
(3) The specified acceleration/ deceleration time was too short.	Recalculate the acceleration/deceleration torque and time needed for the load, based on the moment of inertia for the load and the acceleration/deceleration time. → Increase the acceleration/deceleration time (F07, F08, E10 through E15, and H56).
(4) Overload.	Measure the output current. → Reduce the load (e.g., Use the overload early warning (E34) and reduce the load before the overload protection is activated.). (In winter, the load tends to increase.) → Decrease the motor sound (Carrier frequency) (F26). If the carrier frequency is high, output must be reduced. For details, refer to "2.6 Derating of Rated Output Current." → Enable overload prevention control (H70).
(5) Ventilation paths are blocked.	Check if there is sufficient clearance around the inverter. → Change the mounting place to ensure the clearance. Check if the heat sink is not clogged. → Clean the heat sink.

Possible Causes	What to Check and Suggested Measures
(6) Cooling fan's airflow volume decreased due to the service life expired or failure.	Check the cumulative run time of the cooling fan. (See Chapter 5, Section "5.6.4.4 Viewing Maintenance Information".) → Replace the cooling fan.
	Visually check that the cooling fan rotates normally. → Replace the cooling fan.
(7) The wires to the motor are too long, causing a large leakage current from them.	Measure the leakage current. → Insert an output circuit filter (OFL).

[15] Er1 Memory error

Problem Error occurred in writing the data to the memory in the inverter.

Possible Causes	What to Check and Suggested Measures
(1) When writing data (especially initializing or copying data), the inverter was shut down so that the voltage to the control PCB has dropped.	Initialize the function code data with H03 (= 1). After initialization, check if pressing the  key releases the alarm. → Revert the initialized function code data to their previous settings, then restart the operation.
(2) Inverter affected by strong electrical noise when writing data (especially initializing or copying data).	Check if appropriate noise control measures have been implemented (e.g., correct grounding and routing of control and main circuit wires). Also, perform the same check as described in (1) above. → Implement noise control measures. Revert the initialized function code data to their previous settings, then restart the operation.
(3) The control PCB failed.	Initialize the function code data by setting H03 to "1," then reset the alarm by pressing the  key and check that the alarm goes on. → The control PCB (on which the CPU is mounted) is defective. Contact your Fuji Electric representative.

[16] Er2 Keypad communications error

Problem A communications error occurred between the standard keypad or the multi-function keypad and the inverter.

Possible Causes	What to Check and Suggested Measures
(1) Broken communications cable or poor contact.	Check continuity of the cable, contacts and connections. → Re-insert the connector firmly. → Replace the cable.
(2) Connecting many control wires hinders the front cover from being mounted, lifting the keypad.	Check the mounting condition of the front cover. → Use wires of the recommended size (0.75 mm ²) for wiring. → Change the wiring layout inside the unit so that the front cover can be mounted firmly.
(3) Inverter affected by strong electrical noise.	Check if appropriate noise control measures have been implemented (e.g., correct grounding and routing of communication cables and main circuit wires). → Implement noise control measures. For details, refer to Appendix A.
(4) A keypad failure occurred.	Replace the keypad with another one and check whether a keypad communications error (Er2) occurs. → Replace the keypad.

[17] Er3 CPU error

Problem A CPU error (e.g. erratic CPU operation) occurred.

Possible Causes	What to Check and Suggested Measures
(1) Inverter affected by strong electrical noise.	Check if appropriate noise control measures have been implemented (e.g. correct grounding and routing of signal wires, communications cables, and main circuit wires). ➔ Implement noise control measures.

[18] Er4 Option communications error

Problem A communications error occurred between the option card and the inverter.



Possible Causes	What to Check and Suggested Measures
(1) There was a problem with the connection between the option card and the inverter.	Check whether the connector on the option card is properly engaged with that of the inverter. ➔ Reload the option card into the inverter.
(2) Strong electrical noise.	Check whether appropriate noise control measures have been implemented (e.g. correct grounding and routing of signal wires, communications cables, and main circuit wires). ➔ Implement noise control measures.

[19] Er5 Option error

An error detected by the option card. Refer to the instruction manual of the option card for details.

[20] Er6 Operation protection

Problem An incorrect operation was attempted.

Possible Causes	What to Check and Suggested Measures
(1) The  key was pressed when H96 = 1 or 3.	Check that the  key was pressed when a run command had been entered from the input terminal or through the communications port. ➔ If this was not intended, check the setting of H96.
(2) The start check function was activated when H96 = 2 or 3.	Check that any of the following operations has been performed with a run command being entered. <ul style="list-style-type: none"> - Turning the power ON - Releasing the alarm - Switching the enable communications link <i>LE</i> operation ➔ Review the running sequence to avoid input of a Run command when this error occurs. If this was not intended, check the setting of H96. (Turn the run command OFF before releasing the alarm.)
(3) The forced stop digital input <i>STOP</i> was turned OFF.	Check that turning the <i>STOP</i> OFF decelerated the inverter to stop. ➔ If this was not intended, check the settings of E01 through E07 for terminals [X1] through [X7].

[21] Er7 Tuning error

Problem Auto-tuning failed.

Possible Causes	What to Check and Suggested Measures
(1) A phase was missing (There was a phase loss) in the connection between the inverter and the motor.	→ Properly connect the motor to the inverter.
(2) V/f or the rated current of the motor was not properly set.	Check whether the data of function codes (F04, F05, H50 through H53, P02, and P03) matches the motor specifications.
(3) The wiring length between the inverter and the motor was too long.	Check whether the wiring length between the inverter and the motor exceeds 50 m. (Inverters with a small capacity are greatly affected by the wiring length.) → Review, and if necessary, change the layout of the inverter and the motor to shorten the connection wire. Alternatively, minimize the wiring length without changing the layout. → Disable both auto-tuning and auto-torque boost (set data of F37 to "1").
(4) The rated capacity of the motor was significantly different from that of the inverter.	Check whether the rated capacity of the motor is three or more ranks lower, or two or more ranks higher than that of the inverter. → Replace the inverter with one with an appropriate capacity. → Manually specify the values for the motor parameters P06, P07, and P08. → Disable both auto-tuning and auto-torque boost (set data of F37 to "1").
(5) The motor was a special type such as a high-speed motor.	→ Disable both auto-tuning and auto-torque boost (set data of F37 to "1").
(6) A tuning operation involving motor rotation (P04 = 2 or 3) was attempted while the brake was applied to the motor.	→ Specify the tuning that does not involve the motor rotation (P04 = 1). → Release the brake before tuning that involves the motor rotation (P04 = 2 or 3).

 For details of tuning errors, refer to Chapter 5, Section 5.7.9 "Function code basic settings and tuning < 2 >, ■ Tuning errors."

Preparation before running the motor for a test – Setting function code data."



[22] Er8 RS-485 communications error (COM port 1)
ErP RS-485 communications error (COM port 2)

Problem A communications error occurred during RS-485 communications.

Possible Causes	What to Check and Suggested Measures
(1) Communications conditions of the inverter do not match that of the host equipment.	Compare the settings of the y codes (y01 to y10, y11 to y20) with those of the host equipment. → Correct any settings that differ.
(2) Even though no-response error detection time (y08, y18) has been set, communications is not performed within the specified cycle.	Check the host equipment. → Change the settings of host equipment software or disable the no-response error detection (y08, y18 = 0).
(3) The host equipment did not operate due to defective software, settings, or defective hardware.	Check the host equipment (e.g., PLCs and personal computers). → Remove the cause of the equipment error.
(4) The RS-485 converter did not operate due to incorrect connections and settings, or defective hardware.	Check the RS-485 converter (e.g., check for poor contact). → Change the various RS-485 converter settings, reconnect the wires, or replace hardware with recommended devices as appropriate.
(5) Broken communications cable or poor contact.	Check the continuity of the cables, contacts and connections. → Replace the cable.
(6) Inverter affected by strong electrical noise.	Check if appropriate noise control measures have been implemented (e.g., correct grounding and routing of communications cables and main circuit wires). → Implement noise control measures. → Implement noise reduction measures on the host side. → Replace the RS-485 converter with a recommended insulated one.
(7) Terminating resistor not properly configured.	Check that the inverter serves as a terminating device in the network. → Configure the terminating resistor switch(es) (SW2/SW3) for RS-485 communication correctly. (That is, turn the switch(es) to ON.)

[23] ErF Data saving error during undervoltage

Problem The inverter failed to save data such as the frequency commands and PID commands (which are specified through the keypad), or the output frequencies modified by the **UP/DOWN** terminal commands when the power was turned OFF.

Possible Causes	What to Check and Suggested Measures
(1) During data saving performed when the power was turned OFF, the voltage fed to the control PCB dropped in an abnormally short period due to the rapid discharge of the DC link bus.	Check how long it takes for the DC link bus voltage to drop to the preset voltage when the power is turned OFF. ➔ Remove whatever is causing the rapid discharge of the DC link bus voltage. After pressing the  key and releasing the alarm, return the data of the relevant function codes (such as the frequency commands and PID commands (specified through the keypad) or the output frequencies modified by the UP/DOWN terminal commands) back to the original values and then restart the operation.
(2) Inverter operation affected by strong electrical noise when the power was turned OFF.	Check if appropriate noise control measures have been implemented (e.g., correct grounding and routing of control and main circuit wires). ➔ Implement noise control measures. After pressing the  key and releasing the alarm, return the data of the relevant function codes (such as the frequency commands and PID commands (specified through the keypad) or the output frequencies modified by the UP/DOWN terminal commands) back to the original values and then restart the operation.
(3) The control circuit failed.	Check if ErF occurs each time the power is turned ON. ➔ The control PCB (on which the CPU is mounted) is defective. Contact your Fuji Electric representative.

[24] ErH Hardware error

Problem The LSI on the power printed circuit board malfunctions.

Possible Causes	What to Check and Suggested Measures
(1) The inverter capacity setting on the control printed circuit board is wrong.	It is necessary to set the inverter capacity correctly. ➔ Contact your Fuji Electric representative.
(2) Data stored in the power printed circuit board memory is corrupted.	It is necessary to replace the power printed circuit board. ➔ Contact your Fuji Electric representative.
(3) The control printed circuit board is misconnected to the power printed circuit board.	It is necessary to replace the power or control printed circuit board. ➔ Contact your Fuji Electric representative.

[25] CoF Power input disconnect detection

Problem Power input disconnect is detected.

Possible Causes	What to Check and Suggested Measures
(1) The current signal input to [C1] has fallen to 2 mA or less.	Check the main inverter unit connection and wiring and transmission-side equipment. Review function code (H91) data.

[26] ECL Customizable logic error

Problem An ECL occurred due to a customizable logic setting error.

Possible Causes	What to Check and Suggested Measures
(1) The customizable logic operation selection setting was changed during operation.	Check whether the customizable logic operation selection (function code U00) was changed during operation. → Do avoid potential hazards, do not change the customizable logic operation selection during operation.

[27] ECF Enable circuit error

Problem A circuit error was detected when diagnosing the enable circuit status.

Possible Causes	What to Check and Suggested Measures
(1) Interface board contact defect	Check whether the interface board is securely attached to the unit. → The alarm will be cleared by turning ON the power again.
(2) Enable circuit logic error	Check whether outputs from safety switches and so on are input to both terminals EN1 and EN2 with the same logic (High/High or Low/Low). → The alarm will be cleared by turning ON the power again.
(3) An enable circuit (safety stop circuit) fault (single fault) was detected.	If unable to clear the error with the above procedures, the inverter condition is abnormal. → Contact Fuji Electric.

[28] PVn PID feedback wire break

Problem: The PID feedback wire is broken.

PV1 PID control 1 feedback error

PV2 PID control 2 feedback error

Possible Causes	What to Check and Suggested Measures
(1) The PID feedback signal wire is broken.	Check whether the PID feedback signal wires are connected correctly. → Check whether the PID feedback signal wires are connected correctly. Or, tighten up the related terminal screws. → Check whether any contact part bites the wire sheath.
(2) PID feedback related circuit affected by strong electrical noise.	Check if appropriate noise control measures have been implemented (e.g., correct grounding and routing of signal wires, communication cables, and main circuit wires). → Implement noise control measures. → Separate the signal wires from the main power wires as far as possible.
(3) The function code setting is not appropriate.	The PID control feedback error upper limit (J129, J229) settings are too high. → Review the set feedback value.
	The PID control feedback error lower limit (J130, J230) settings are too low. → Review the set feedback value.

[29] PVn External PID feedback wire break

Problem: The PID feedback wire is broken.

PVA External PID control 1 feedback error

PVB External PID control 2 feedback error

PVC External PID control 3 feedback error

Possible Causes	What to Check and Suggested Measures
(1) The PID feedback signal wire is broken.	<p>Check whether the PID feedback signal wires are connected correctly.</p> <p>➔ Check whether the PID feedback signal wires are connected correctly. Or, tighten up the related terminal screws.</p> <p>➔ Check whether any contact part bites the wire sheath.</p>
(2) PID feedback related circuit affected by strong electrical noise.	<p>Check if appropriate noise control measures have been implemented (e.g., correct grounding and routing of signal wires, communication cables, and main circuit wires).</p> <p>➔ Implement noise control measures.</p> <p>➔ Separate the signal wires from the main power wires as far as possible.</p>
(3) The function code setting is not appropriate.	<p>The external PID control feedback error upper limit (J529, J629, J679) settings are too high.</p> <p>➔ Review the set feedback value.</p>
	<p>The external PID control feedback error lower limit (J530, J630, J680) settings are too low.</p> <p>➔ Review the set feedback value.</p>

[30] Pdr Dry pump protection

Problem Drought conditions were detected during PID control.

Possible Causes	What to Check and Suggested Measures
(1) The water level in the water tank has dropped to the drought position.	<p>Check whether the water level in the water tank is sufficient.</p> <p>➔ Check whether the correct amount of water is being supplied to the water tank.</p> <p>➔ Check whether the motor-operated valve is closed.</p>
(2) Water is leaking from the pipes or pump system.	<p>Check whether water is leaking from the pump system or from around the pipes.</p> <p>➔ Check whether water is leaking from the pump itself.</p> <p>➔ Check for cracks in the pipes and so on, and check whether water is leaking from the connections between pipes. Increase the tightening at the pipe connections.</p>
(3) The function code setting is not appropriate.	<p>Check whether the drought protection (detection current) (J177, J277) setting is too high.</p> <p>➔ Review the set current value.</p>
	<p>Check whether the drought protection (deviation) (J178, J278) setting is too small.</p> <p>➔ Review the set amount of deviation.</p>

Possible Causes	What to Check and Suggested Measures
(4) The function code setting for the flow sensor is not appropriate. (This applies only when drought protection (flow sensor) (J179, J279) is set to “1: Operate”.)	A flow sensor has not been assigned to digital input or analog input. ➔ If inputting a flow sensor signal by digital input, assign a “flow sensor” to E01 through E07, E98, and E99. ➔ If inputting a flow sensor signal by analog input, assign a “flow sensor” to E61 through E63.
	If inputting a flow sensor signal by digital input, check whether the <i>FS</i> logic and external signal logic (positive and negative) set at E01 through E07, E98, and E99 matches. ➔ Set the logic correctly.
	If inputting a flow sensor signal by analog input, the flow sensor OFF level (J165) is too high. ➔ Review the set OFF level setting.
(5) The flow sensor signal wiring is damaged.	Check whether the flow sensor signal wire is connected properly. ➔ Check whether the flow sensor signal wire is connected properly. Or alternatively, tighten the screws. ➔ Check whether the connection coating is caught.

[31] roC Control of maximum starts per hour

Problem A PID control insufficient water stoppage occurred frequently.

Possible Causes	What to Check and Suggested Measures
(1) PID feedback signal wire contact defect	Check whether the PID feedback signal wire is connected properly. ➔ Check whether the PID feedback signal wire is connected properly. Or alternatively, tighten the screws. ➔ Check whether the connection coating is caught.
(2) An accumulator (hydraulic regeneration) fault occurred due to such reasons as the lifetime being reached.	Check the accumulator parts. ➔ Replace the accumulator.

[32] PoL End of curve protection

Problem A large water quantity condition was detected during PID control.

Possible Causes	What to Check and Suggested Measures
(1) The PID feedback signal wiring is damaged.	Check whether the PID feedback signal wire is connected properly. ➔ Check whether the PID feedback signal wire is connected properly. Or alternatively, tighten the screws. ➔ Check whether the connection coating is caught.
(2) There is insufficient pump capacity or there are not enough pumps.	Check whether the required amount of supply water is being supplied properly. ➔ Increase the number of pumps. ➔ Increase the pump capacity.
(3) The function code setting is not appropriate.	Check whether the large water quantity protection (detection current) (J183) setting is too low. ➔ Review the set current value.
	Check whether the large water quantity protection (deviation) (J184) setting is too small. ➔ Review the set amount of deviation.

Possible Causes	What to Check and Suggested Measures
(4) The function code setting for the flow sensor is not appropriate. (This applies only when drought protection (flow sensor) (J179, J279) is set to "1: Operate".)	If inputting a flow sensor signal by digital input, check whether the FS logic and external signal logic (positive and negative) set at E01 through E07, E98, and E99 matches. ➔ Set the logic correctly.
	If inputting a flow sensor signal by analog input, the flow sensor ON level (J165) is too low. ➔ Review the set ON level setting.

[33] rLo Anti jam

Problem Impurities became trapped in the pump impeller, and an overcurrent was detected.

Possible Causes	What to Check and Suggested Measures
(1) Impurities are trapped in the pump impeller.	Check for any impurities in the suction side water tank or well. ➔ Check for any impurities inside the pump. ➔ Eliminate any impurities from the water tank or well as best as possible.
(2) A pump fault occurred due to such reasons as the lifetime being reached.	Check the pump parts. ➔ Check whether an abnormal noise is being emitted by the pump. ➔ Check whether the pump bearings are overheating.

[34] FoL Filter clogging error

Problem An overload condition was detected during PID control.

Possible Causes	What to Check and Suggested Measures
(1) The filter of the fan being driven by the inverter is clogged with dust.	Check whether the fan filter is clogged with dust. ➔ Check whether the filter is clogged with dust. ➔ Clean or replace the filter.
(2) A fault occurred in the fan being driven by the inverter due to the fan's service life expired, etc.	Check the fan parts. ➔ Check whether an abnormal noise is being emitted by the fan. ➔ Check whether the fan bearings are overheating.
(3) The function code setting is not appropriate.	Check whether the filter clogging (load resistance current) (J190) setting is too low. ➔ Check the set current value.
	Check whether the filter clogging (load resistance PV signal) (J191) setting is too low. ➔ Check the set feedback value.





[35] LoK Password protection (inverter lock)

Problem An incorrect user password was entered more than the specified number of times.

Possible Causes	What to Check and Suggested Measures
(1) User password 1 or 2 was entered incorrectly more than the specified number of times.	Delete the password setting. → Delete the password with the all clear command (PRG >5 > 2 >10). When doing so, all inverter settings will also be initialized simultaneously. Reset the password. → To clear the Lok alarm while retaining the inverter settings, notify Fuji Electric and append the clear application number (PRG > 5 > 8). We will ensure that no illegal operations have been performed, and then issue an alarm clear code.

[36] Err Mock alarm

Problem The LCD displays the alarm *err*.

Possible Causes	What to Check and Suggested Measures
(1) The  +  keys were held down for more than 5 seconds.	→ To escape from this alarm state, press the  key.
(2) H45 was set to “1”.	→ Press the  key to reset

[37] Lob Low battery

Problem The voltage in the battery used to protect date information is low.

Possible Causes	What to Check and Suggested Measures
(1) Battery connector contact defect	Check whether the battery is securely attached to the connector on the unit board. → If normal battery voltage is detected, the cause of the problem will be cleared, and resetting will be possible.
(2) Battery degradation, battery defect	Check whether the battery is degraded. → Replace the battery with a new one.

[38] dtL Date information loss

Problem Date information set in the inverter was lost.

Possible Causes	What to Check and Suggested Measures
(1) It was not possible to protect the date information when the inverter power was turned OFF.	Check whether the date information protection battery is properly connected. → Check the battery connection, and then reset the date.
(2) The date information is abnormal.	The clock function in this product is programmed to run until 23:59:59 on December 31, 2099. The date count will be stopped if this date is exceeded. → Set the correct date again.



To stop using the clock function (realtime clock), perform “Realtime clock initialization (H03=10)”.

9.3.2 If the "Light Alarm" Indication Appears

When an error is detected and the error is determined to be a light alarm, operation can be continued without tripping the inverter while outputting a warning (display and general purpose output terminal).

If a light alarm occurs, the WARN. LED starts flashing, and the light alarm factor is displayed on the screen.

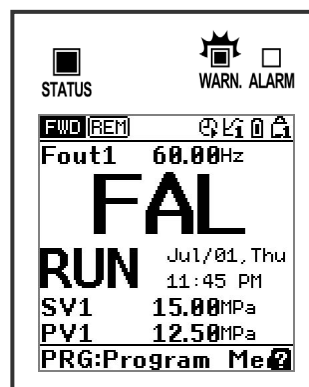

Fig. 9.1 Light alarm display example

If a light alarm occurs, a light alarm "L-ALM" is output to the multi-purpose output terminal (It is necessary to assign a light alarm "L-ALM" (data = 98) to function codes E20 through E24, and E27.)

Light alarm operations can be selected with function codes H181 through H182. The available "light alarm" codes are check-marked in the "Light alarm" object column in Table 9.1.

To display the "light alarm" factor and escape from the light alarm state, follow the instructions below.

■ Checking the light alarm content.

- 1) Press the (PRG) key to enter Programming mode.
- 2) Select program mode (PRG) > 4(Alarm Info) > 2(Warning History) to check the light alarm content. Light alarm codes are displayed in order of new alarms first. Refer to Table 9.1 for details on the codes.

■ Releasing the light alarm

- 1) Eliminate the cause of the light alarm in accordance with the troubleshooting procedure applicable to the light alarm content (code) checked in the maintenance information. Refer to the "Ref. page" in Table 9.1 for information on troubleshooting and explanations.
- 2) After confirming the light alarm, clear the alarm display. To return to the normal state, either press the (RESET) key in the operating mode status similar to the same procedure used to release the alarm, enter multi-purpose input terminal alarm reset command **RST**, or enter the alarm reset command by communication.

If the light alarm factor is successfully eliminated, the WARN. LED turns OFF, the light alarm code displayed at the screen changes to the normal display, and multi-purpose output **L-ALM** also turns off.

If unable to successfully eliminate the light alarm factor (e.g., when a DC fan lock is detected), the WARN. LED turns ON, and the light alarm code displayed on the screen and multi-purpose output **L-ALM** remain ON (factor elimination reserved). When the light alarm factor is later eliminated, the WARN. LED turns OFF automatically, the light alarm code displayed on the screen changes to the normal display, and multi-purpose output **L-ALM** also turns OFF.

■ Light alarm release operation and LCD display

- 1) If releasing the light alarm after the factor has been eliminated

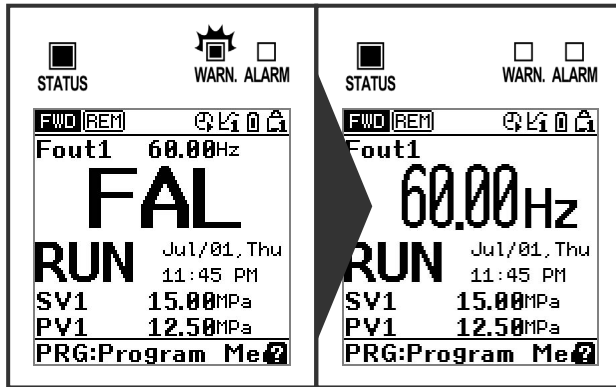

Light alarm (no factor) Released (normal display)

- 2) If the factor is eliminated after first releasing the light alarm

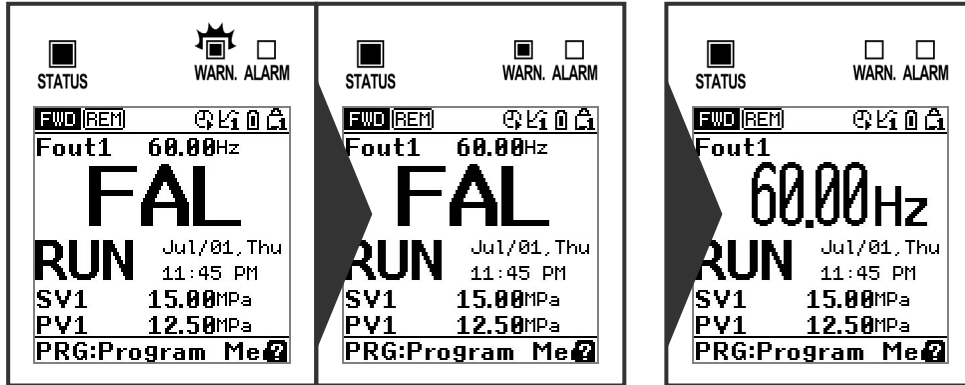

Light alarm (factor exists) Light alarm release reservation (factor exists) Released (normal display)

9.4 Nothing appears on the monitor

9.4.1 Abnormal motor operation

[1] The motor does not rotate.





Possible Causes	What to Check and Suggested Measures
(1) No power supplied to the inverter.	<p>Check the input voltage and interphase voltage unbalance.</p> <ul style="list-style-type: none"> ➔ Turn ON a molded case circuit breaker (MCCB), a residual-current-operated protective device (RCD)/earth leakage circuit breaker (ELCB) (with overcurrent protection) or a magnetic contactor (MC). ➔ Check for voltage drop, phase loss, poor connections, or poor contacts, and fix them if necessary. ➔ If only the auxiliary control power input is supplied, also supply the main power to the inverter.
(2) No forward/reverse operation command was inputted, or both the commands were inputted simultaneously (external signal operation).	<p>Check the input status of the forward/reverse command with Menu "I/O Checking" using the keypad.</p> <ul style="list-style-type: none"> ➔ Input a run command. ➔ Set either the forward or reverse operation command to off if both commands are being inputted. ➔ Correct the run command source. (Set F02 data to "1.") ➔ Correct the assignment of commands <i>FWD</i> and <i>REV</i> with function codes E98 and E99. ➔ Connect the external circuit wires to control circuit terminals [FWD] and [REV] correctly. ➔ Make sure that the sink/source slide switch (SW1) on the control printed circuit board (control PCB) is properly configured.
(3) No indication of rotation direction (keypad operation).	<p>Check the input status of the forward/reverse rotation direction command with Menu "I/O Checking" using the keypad.</p> <ul style="list-style-type: none"> ➔ Input the rotation direction (F02 = 0), or select the keypad operation with which the rotation direction is fixed (F02 = 2 or 3).
(4) The inverter could not accept any run commands from the keypad since it was in Programming mode.	<p>Check which operation mode the inverter is in, using the keypad.</p> <ul style="list-style-type: none"> ➔ Shift the operation mode to Running mode and enter a run command.
(5) A run command with higher priority than the one attempted was active, and the run command was stopped.	<p>Referring to the block diagram of the frequency command block (refer to Chapter 7), check the higher priority run command with Menu "Data Checking" and Menu "I/O Checking" using the keypad.</p> <ul style="list-style-type: none"> ➔ Correct any incorrect function code data settings (in H30, y98, etc.) or cancel the higher priority run command.
(6) No analog frequency command input.	<p>Check whether the analog frequency command (reference frequency) is correctly inputted, using Menu #4 "I/O Checking" on the keypad.</p> <ul style="list-style-type: none"> ➔ Connect the external circuit wires to terminals [13], [12], [11], [C1], and [V2] correctly. ➔ When the terminal [C1] is used, check the slider position of the terminal [C1] property switch (SW5) and the setting of the thermistor mode selection (H26).

Possible Causes	What to Check and Suggested Measures
(7) The reference frequency was below the starting or stop frequency.	<p>Check that a reference frequency has been entered correctly, using Menu "I/O Checking" on the keypad.</p> <ul style="list-style-type: none"> ➔ Set the reference frequency at the same or higher than that of the starting and stop frequencies (F23 and F25). ➔ Reconsider the starting and stop frequencies (F23 and F25), and if necessary, change them to the lower values. ➔ Inspect the external frequency command potentiometers, signal converters, switches, and relay contacts. Replace any ones that are faulty. ➔ Connect the external circuit wires to terminals [13], [12], [11], [C1], and [V2] correctly.
(8) A frequency command with higher priority than the one attempted was active.	<p>Check the higher priority run command with Menu "Data Checking" and Menu "I/O Checking" using the keypad, referring to the block diagram of the frequency command block (refer to Chapter 7).</p> <ul style="list-style-type: none"> ➔ Correct any incorrect function code data (e.g. cancel the higher priority run command).
(9) The upper and lower frequencies for the frequency limiters were set incorrectly.	<p>Check the data of function codes F15 (Frequency limiter (High)) and F16 (Frequency limiter (Low)).</p> <ul style="list-style-type: none"> ➔ Change the settings of F15 and F16 to the correct ones.
(10) The coast-to-stop command was effective.	<p>Check the data of function codes E01 through E07, E98, and E99 and the input signal status, using Menu "I/O Checking" on the keypad.</p> <ul style="list-style-type: none"> ➔ Release the coast-to-stop command setting.
(11) Broken wires, incorrect connection or poor contact with the motor.	<p>Check the wiring (Measure the output current).</p> <ul style="list-style-type: none"> ➔ Repair the wires to the motor, or replace them.
(12) Overload	<p>Measure the output current.</p> <ul style="list-style-type: none"> ➔ Reduce the load (In winter, the load tends to increase.)
	<p>Check whether any mechanical brake is activated.</p> <ul style="list-style-type: none"> ➔ Release the mechanical brake, if any.
(13) Torque generated by the motor was insufficient.	<p>Check that the motor starts running if the value of torque boost (F09) is increased.</p> <ul style="list-style-type: none"> ➔ Increase the value of torque boost (F09) and try to run the motor.
	<p>Check the data of function codes F04, F05, H50, H51, H52 and H53.</p> <ul style="list-style-type: none"> ➔ Change the V/f pattern to match the motor's characteristics.
	<p>Check that the motor switching signal (motor selection) is correct and the data of function codes matches each motor.</p> <ul style="list-style-type: none"> ➔ Correct the motor switching signal. ➔ Modify the function code data to match the connected motor.
	<p>Check whether the reference frequency is below the slip-compensated frequency of the motor.</p> <ul style="list-style-type: none"> ➔ Change the reference frequency so that it becomes higher than the slip-compensated frequency of the motor.

[2] The motor rotates, but the speed does not increase.

Possible Causes	What to Check and Suggested Measures
(1) The maximum frequency currently specified was too low.	Check the data of function code F03 (Maximum frequency). → Correct the F03 data.
(2) The data of frequency limiter (High) currently specified was too low.	Check the data of function code F15 (Frequency limiter (High)). → Correct the F15 data.
(3) The reference frequency currently specified was too low.	Check that the reference frequency has been entered correctly, using Menu #4 "I/O Checking" on the keypad. → Increase the reference frequency. → Inspect the external frequency command potentiometers, signal converters, switches, and relay contacts. Replace any ones that are faulty. → Connect the external circuit wires to terminals [13], [12], [11], [C1], and [V2] correctly.
(4) A frequency command (e.g., multi-frequency or via communications) with higher priority than the one attempted was active and its reference frequency was too low.	Check the data of the relevant function codes and what frequency commands are being received, through Menu "Data Setting," Menu "Data Checking" and Menu "I/O Checking," on the keypad by referring to the block diagram of the frequency command (refer to Chapter 7). → Correct any incorrect data of function codes (e.g. cancel the higher priority frequency command).
(5) The acceleration time was too long or too short.	Check the data of function codes F07, E10, E12, and E14 (Acceleration time). → Change the acceleration time to match the load.
(6) Overload.	Measure the output current. → Reduce the load. Check whether any mechanical brake is activated. → Release the mechanical brake.
(7) Function code settings do not agree with the motor characteristics.	If auto-torque boost or auto-energy saving operation is specified, check whether the data of P02, P03, P06, P07, and P08 agree with the parameters of the motor. → Perform auto-tuning of the inverter for the motor to be used.
(8) The output frequency does not increase due to the current limiter operation.	Make sure that F43 (Current limiter (Mode selection)) is set to "2" and check the data of F44 (Current limiter (Level)). → Correct the F44 data. Or, if the current limiter operation is not needed, set F43 to "0" (disabled).
	Decrease the value of torque boost (F09), then run the motor again and check if the speed increases. → Adjust the value of the torque boost (F09).
	Check the data of function codes F04, F05, H50, H51, H52 and H53 to ensure that the V/f pattern setting is right. → Match the V/f pattern setting with the motor ratings.
(9) The output frequency does not increase due to the torque limiter operation.	Check whether data of torque limiter related function codes (F40, F41, E16 and E17) is correctly configured and the "Select torque limiter level" terminal command TL2/TL1 is correct. → Correct data of F40, F41, E16 and E17 or reset them to the factory defaults (disable). → Set the TL2/TL1 correctly.
(10) Bias and gain incorrectly specified.	Check the data of function codes F18, C50, C32, C34, C37, C39, C42, and C44. → Readjust the bias and gain to appropriate values.

[3] The motor runs in the opposite direction to the command.

Possible Causes	What to Check and Suggested Measures
(1) Wiring to the motor is incorrect.	Check the wiring to the motor. ➔ Connect terminals U, V, and W of the inverter to the U, V, and W terminals of the motor, respectively.
(2) Incorrect connection and settings for run commands and rotation direction commands <i>FWD</i> and <i>REV</i> .	Check the data of function codes E98 and E99 and the connection to terminals [FWD] and [REV]. ➔ Correct the data of the function codes and the connection.
(3) A run command (with fixed rotational direction) from the keypad is active, but the rotational direction setting is incorrect.	Check the data of function code F02 (Run command). ➔ Change the data of function code F02 to "2:  /  keys on keypad (forward)" or "3:  /  keys on keypad (reverse)."
(4) The rotation direction specification of the motor is opposite to that of the inverter.	The rotation direction of IEC-compliant motors is opposite to that of incompliant motors. ➔ Switch the <i>FWD/REV</i> signal setting.

[4] Speed fluctuation or current oscillation (e.g., hunting) occurs during running at constant speed.

Possible Causes	What to Check and Suggested Measures
(1) The frequency command fluctuates.	Check the signals for the frequency command with Menu #4 "I/O Checking" using the keypad. ➔ Increase the filter constants (C33, C38, and C43) for the frequency command.
(2) An external frequency command potentiometer is used for frequency setting.	Check that there is no noise in the control signal wires from external sources. ➔ Isolate the control signal wires from the main circuit wires as far as possible. ➔ Use shielded or twisted wires for control signals.
	Check whether the external frequency command potentiometer is malfunctioning due to noise from the inverter. ➔ Connect a capacitor to the output terminal of the potentiometer or set a ferrite core on the signal wire. (Refer to Chapter 2.)
(3) Frequency switching or multi-frequency command was enabled.	Check whether the relay signal for switching the frequency command is chattering. ➔ If the relay contact is defective, replace the relay.
(4) The wiring length between the inverter and the motor is too long.	Check whether auto-torque boost, auto-energy saving operation, or dynamic torque vector control is enabled. ➔ Perform auto-tuning of the inverter for every motor to be used. ➔ Disable the automatic control systems by setting F37 to "1" (Constant torque load) and F42 to "0" (V/f control with slip compensation active), then check that the motor vibration stops. ➔ Make the output wires as short as possible.
(5) The machinery is hunting due to vibration caused by low rigidity of the load. Or the current is irregularly oscillating due to special motor parameters.	Once disable all the automatic control systems such as auto torque boost, auto energy saving operation, overload prevention control, current limiter, torque limiter, automatic deceleration (anti-regenerative control), auto search for idling motor speed, slip compensation, dynamic torque vector control, online tuning, and then check that the motor vibration comes to a stop. ➔ Disable the functions causing the vibration. ➔ Readjust the output current fluctuation damping gain (H80).
	Check that the motor vibration is suppressed if you decrease the level of F26 (Motor sound (Carrier frequency)) or set F27 (Motor sound (Tone)) to "0." ➔ Decrease the carrier frequency (F26) or set the tone to "0" (F27 = 0).

[5] Grating sound is heard from the motor or the motor sound fluctuates.

Possible Causes	What to Check and Suggested Measures
(1) The specified carrier frequency is too low.	<p>Check the data of function codes F26 (Motor sound (Carrier frequency)) and F27 (Motor sound (Tone)).</p> <ul style="list-style-type: none"> ➔ Increase the carrier frequency (F26). If the carrier frequency is set too high, current derating is required. For details, refer to Section 2.6 "Derating of Rated Output Current." ➔ Change the setting of F27 to appropriate value.
(2) The ambient temperature of the inverter was too high (when automatic lowering of the carrier frequency was enabled by H98).	<p>Measure the temperature inside the panel where the inverter is mounted.</p> <ul style="list-style-type: none"> ➔ If it is over 40°C, lower it by improving the ventilation. ➔ Lower the temperature of the inverter by reducing the load. (For fans or pumps, decrease the frequency limiter value (F15).) <p>Note: If you disable H98, an OH1, OH3, or OLU alarm may occur.</p>
(3) Resonance with the load.	<p>Check the machinery mounting accuracy or check whether there is resonance with the mounting base.</p> <ul style="list-style-type: none"> ➔ Disconnect the motor from the machinery and run it alone, then find where the resonance comes from. Upon locating the cause, improve the characteristics of the source of the resonance. ➔ Adjust the settings of C01 (Jump frequency 1) to C04 (Jump frequency (Hysteresis width)) so as to avoid continuous running in the frequency range causing resonance.

[6] The motor does not accelerate or decelerate within the specified time.

Possible Causes	What to Check and Suggested Measures
(1) The inverter runs the motor with S-curve or curvilinear pattern.	<p>Check the data of function code H07 (Acceleration/deceleration pattern).</p> <ul style="list-style-type: none"> ➔ Select the linear pattern (H07 = 0). ➔ Shorten the acceleration/deceleration time (F07, E10 through E15).
(2) The current limiting operation prevented the output frequency from increasing (during acceleration).	<p>Make sure that F43 (Current limiter (Mode selection)) is set to "2: Enable during acceleration and at constant speed," then check that the setting of F44 (Current limiter (Level)) is reasonable.</p> <ul style="list-style-type: none"> ➔ Readjust the setting of F44 to appropriate value, or disable the function of current limiter with F43. ➔ Increase the acceleration/deceleration time (F07, F08, E10 through E15).
(3) The automatic deceleration (Anti-regenerative control) is enabled during deceleration.	<p>Check the data of function code H69 (Automatic deceleration (Mode selection)).</p> <ul style="list-style-type: none"> ➔ Increase the deceleration time (F08, E11, E13, and E15).
(4) Overload.	<p>Measure the output current.</p> <ul style="list-style-type: none"> ➔ Reduce the load (For fans or pumps, decrease the frequency limiter value (F15).) (In winter, the load tends to increase.)
(5) Torque generated by the motor was insufficient.	<p>Check that the motor starts running if the value of the torque boost (F09) is increased.</p> <ul style="list-style-type: none"> ➔ Increase the value of the torque boost (F09).
(6) An external frequency command potentiometer is used for frequency setting.	<p>Check that there is no noise in the control signal wires from external sources.</p> <ul style="list-style-type: none"> ➔ Isolate the control signal wires from the main circuit wires as far as possible. ➔ Use shielded or twisted wires for control signals. ➔ Connect a capacitor to the output terminal of the potentiometer or set a ferrite core on the signal wire. (Refer to Chapter 2.)

Possible Causes	What to Check and Suggested Measures
(7) The output frequency is limited by the torque limiter.	<p>Check whether data of torque limiter related function codes (F40, F41, E16 and E17) is correctly configured and the TL2/TL1 terminal command ("Select torque limiter level 2/1") is correct.</p> <ul style="list-style-type: none"> ➔ Correct the data of F40, F41, E16 and E17 or reset them to the factory defaults. ➔ Set the TL2/TL1 correctly. ➔ Increase the acceleration/deceleration time (F07, F08, E10 through E15).
(8) The specified acceleration or deceleration time was incorrect.	<p>Check the terminal commands RT1 and RT2 for acceleration/ deceleration times.</p> <ul style="list-style-type: none"> ➔ Correct the RT1 and RT2 settings.

[7] The motor does not restart even after the power recovers from a momentary power failure.

Possible Causes	What to Check and Suggested Measures
(1) The data of function code F14 is either "0," "1," or "2."	<p>Check if an undervoltage trip (LV) occurs.</p> <ul style="list-style-type: none"> ➔ Change the data of function code F14 (Restart mode after momentary power failure (Mode selection)) to "3," "4," or "5."
(2) The run command remains OFF even after the power has been restored.	<p>Check the input signal with Menu "I/O Checking" using the keypad.</p> <ul style="list-style-type: none"> ➔ Check the power recovery sequence with an external circuit. If necessary, consider the use of a relay that can keep the run command ON. <p>In 3-wire operation, the power to the control printed circuit board (control PCB) has been shut down once because of a long momentary power failure time, or the "Enable 3-wire operation" signal HOLD has been turned OFF once.</p> <ul style="list-style-type: none"> ➔ Change the design or the setting so that a run command can be issued again within 2 seconds after the power has been restored.

[8] The motor abnormally heats up.

Possible Causes	What to Check and Suggested Measures
(1) Excessive torque boost specified.	<p>Check whether decreasing the torque boost (F09) decreases the output current but does not stall the motor.</p> <ul style="list-style-type: none"> ➔ If no stall occurs, decrease the torque boost (F09).
(2) Continuous running in extremely slow speed.	<p>Check the running speed of the inverter.</p> <ul style="list-style-type: none"> ➔ Change the speed setting or replace the motor with a motor exclusively designed for inverters.
(3) Overload.	<p>Measure the inverter output current.</p> <ul style="list-style-type: none"> ➔ Reduce the load (For fans or pumps, decrease the frequency limiter value (F15).) (In winter, the load tends to increase.)

[9] The motor does not run as expected.

Possible Causes	What to Check and Suggested Measures
(1) Incorrect setting of function code data.	Check that function codes are correctly configured and no unnecessary configuration has been done. ➔ Configure all the function codes correctly.
	Make a note of function code data currently configured and then initialize all function code data using H03. ➔ After the above process, reconfigure function codes one by one, checking the running status of the motor.
(2) The forced operation function is in use.	Check whether the set function code is correct, or whether an unnecessary setting has been specified. ➔ Check the forced operation selection (H116) setting. ➔ Check the digital input terminal forced operation command <i>FMS</i> .

9.4.2 Problems with inverter settings

[1] Nothing appears on the LCD monitor.

Possible Causes	What to Check and Suggested Measures
(1) No power (neither main power nor auxiliary control power) supplied to the inverter.	Check the input voltage and interphase voltage unbalance. → Turn ON a molded case circuit breaker (MCCB), a residual-current-operated protective device (RCD)/earth leakage circuit breaker (ELCB) (with overcurrent protection) or a magnetic contactor (MC). → Check for voltage drop, phase loss, poor connections, or poor contacts and fix them if necessary.
(2) The keypad was not properly connected to the inverter.	Check whether the keypad is properly connected to the inverter. → Remove the keypad, put it back, and see whether the problem recurs. → Replace the keypad with another one and check whether the problem recurs. When running the inverter remotely, ensure that the extension cable is securely connected both to the keypad and to the inverter. → Disconnect the cable, reconnect it, and see whether the problem recurs. → Replace the keypad with another one and check whether the problem recurs.

[2] Connecting... display

Problem The “Connecting...” display does not change.

Possible Causes	What to Check and Suggested Measures
(1) The keypad is poorly connected.	Check the remote operation extension cable conductance. → Replace the remote operation extension cable conductance.

[3] “This inverter is not supported.” display

Problem “This inverter is not supported.” is displayed and the keypad turns ON and OFF repeatedly.

Possible Causes	What to Check and Suggested Measures
(1) The keypad and inverter are not compatible.	Check the keypad and inverter compatibility. → Connect a keypad that is compatible with the inverter.

[4] “USB Connected.” display

Problem “USB Connected.” is displayed and operation is not possible.



Possible Causes	What to Check and Suggested Measures
(1) A USB cable is connected to the inverter.	The inverter has been set to USB communication mode by connecting it to the computer via a USB cable. → If not necessary to connect to the computer, disconnect the USB cable.

[5] Menu cannot be selected./Menu does not display.

Problem A  mark appears at some menu items, and they cannot be selected. Menu items do not display.

Possible Causes	What to Check and Suggested Measures
(1) A user password has been set, thus enabling protection.	Check whether a password has been set. ➔ Delete the password at PRG > 5(User Config) > 2(Password). Refer to Chapter 5, Section 5.6.6.2 for details on how to delete the password.
(2) These menu items are password protected (inverter lock).	With Lok alarm “password protection (inverter lock)”, many menu items are restricted to prevent tampering with the inverter. ➔ Cancel the LoK alarm. Refer to [34] in Section 9.3.1 for details on how to cancel the alarm.

[6] Data of function codes cannot be changed.



Possible Causes	What to Check and Suggested Measures
(1) An attempt was made to change function code data that cannot be changed when the inverter is running.	Check if the inverter is running with Menu "Drive Monitoring" using the keypad and then confirm whether the data of the function codes can be changed when the motor is running by referring to the function code tables. ➔ Stop the motor then change the data of the function codes.
(2) The data of the function codes is protected.	Check the data of function code F00 (Data Protection). ➔ Change the F00 data from "Enable data protection" (1 or 3) to "Disable data protection" (0 or 2).
(3) The WE-KP terminal command ("Enable data change with keypad") is not entered, though it has been assigned to a digital input terminal.	Check the data of function codes E01 through E09, E98 and E99 and the input signal status with Menu "I/O Checking" using the keypad. ➔ Input a WE-KP command through a digital input terminal.
(4) The  key was not pressed.	Check whether you have pressed the  key after changing the function code data. ➔ Press the  key after changing the function code data. Ensure that “Writing...” appears on the screen.
(5) Terminal commands “FWD” and “REV” are on. (Data for function codes F02, E01 through E07, E98, and E99 cannot be changed.)	Either one of the FWD and REV terminal commands is turned ON. ➔ Turn OFF both FWD and REV .

Possible Causes	What to Check and Suggested Measures
(6) The function code is not applicable to quick setup. (The function code to be changed does not display.)	Check whether Quick Setup (PRG > 0) is open. This menu displays only specific function codes that have been selected beforehand. → Change the relevant function code at PRG > 2(Function code) > 1(Data Set). All function codes appear in this menu. → Add the function code for which quick setup is to be performed at PRG > 5(User Config) > 1(Select Q.Setup). (Display the function code and then change the data.)
(7) Function code settings are protected with a password. (It is not possible to display the Function Code Settings screen.)	Check whether a password has been set. → Delete the password at PRG > 5(User Config) > 2(Password). Refer to Chapter 5, Section 5.6.6.2 for details on how to delete the password.
(8) The code cannot be changed at the Function Code Settings screen. (“Change this in dedicated menus.” appears.)	Settings cannot be changed from function codes for which dedicated menus exist (T codes, certain K codes). → Display function codes and change data at the dedicated menus for PRG > 1(Start-up) > 3(Date/Time) Clock Setting or function code PRG > 2(Function Code) > 5(Timer Setup) Timer Operation.
(9) Terminal command RST is ON. (Function code P04 data cannot be changed.)	Check the data for function codes E01 through E07, E98, and E99, and use the keypad to check the input status by performing an I/O check from the menu. → Turn OFF the digital input terminal alarm reset command RST .

9.5 If Other than an Alarm Code is Displayed

[1] - - - - (center bar) appears

Problem A center bar (- - - -) appeared on the LCD monitor.

Possible Causes	What to Check and Suggested Measures
(1) With the PID being enabled (J01 = 1, 2, or 3), you disabled PID control (J01 = 0) when the LCD monitor had been set to display the PID command or PID feedback amount by pressing the  key.	Make sure that when you wish to view a PID command or a PID feedback amount, J01 (PID control) is not set to "0: Disable." → Set J01 to "1: Enable (Process control normal operation)," "2: Enable (Process control inverse operation)," or "3: Enable (Dancer control)."
(2) The keypad was poorly connected.	Prior to proceed, check that pressing the  key does not change the display on the LCD monitor. Check continuity of the extension cable for the keypad used in remote operation. → Replace the cable.

[2] OVER+ / OVER- Display

Problem The display data exceeds the maximum number of display digits. (OVER+: positive value, OVER-: negative value)

Possible Causes	What to Check and Suggested Measures
(1) The display data has overflowed.	Please verify the settings of the corresponding function.

Chapter 10

MAINTENANCE AND INSPECTION

This chapter provides the instructions on how to perform daily and periodic inspections in order to avoid trouble and keep reliable operation of the inverter for a long time.

Contents

10.1 Daily Inspection	10-1
10.2 Periodic Inspection.....	10-1
10.3 List of Periodic Replacement Parts	10-3
10.3.1 Judgment on service life.....	10-4
10.4 Measurement of Electrical Amounts in Main Circuit	10-8
10.5 Insulation Test	10-9
10.6 Cooling Fan Replacement Procedure.....	10-10

⚠ CAUTION

- Before proceeding to the maintenance/inspection jobs, **turn OFF the power and wait at least ten minutes.** Make sure that the LCD monitor is turned OFF. Further, make sure, using a multimeter or a similar instrument, that the DC link bus voltage between the terminals P(+) and N(-) has dropped to the safe level (+25 VDC or below).

Electric shock may occur.

- Maintenance, inspection, and parts replacement should be made only by authorized persons.
- Take off the watch, rings and other metallic objects before starting work.
- Use insulated tools.
- Never modify the inverter.

Electric shock or injuries could occur.

10.1 Daily Inspection

Visually inspect the inverter for operation errors from the outside without removing the covers when the inverter is ON or operating.

- Check that the expected performance (satisfying the standard specifications) is obtained.
- Check that the surrounding environment satisfies the requirements given in Chapter 2, Section 2.7 "Operating Environment and Storage Environment."
- Check that the LCD monitor and LED indicators on the keypad work normally.
- Check for abnormal noise, odor, or excessive vibration.
- Check for traces of overheat, discoloration and other defects.

10.2 Periodic Inspection

Perform periodic inspections according to the items listed in Table 10.1. Before performing periodic inspections, be sure to stop the motor and remove the front cover with the inverter power OFF.

Table 10.1 List of Periodic Inspections

Check part	Check item	How to inspect	Evaluation criteria
Environment	1) Check the ambient temperature, humidity, vibration and atmosphere (dust, gas, oil mist, or water drops). 2) Check that tools or other foreign materials or dangerous objects are not left around the equipment.	1) Check visually or measure using apparatus. 2) Visual inspection	1) The standard specifications must be satisfied. 2) No foreign or dangerous objects are left.
Input voltage	Check that the input voltages of the main and control circuits are correct.	Measure the input voltages using a multimeter or the like.	The standard specifications must be satisfied.
Keypad	1) Check that the display is clear. 2) Check that there is no missing part in the displayed characters.	1), 2) Visual inspection	1), 2) The display can be read and there is no fault.

Table 10.1 List of Periodic Inspections (Continued)

Check part	Check item	How to inspect	Evaluation criteria
Structure such as frame and covers	Check for: 1) Abnormal noise or excessive vibration 2) Loose bolts (at clamp sections). 3) Deformation and breakage 4) Discoloration caused by overheat 5) Contamination and accumulation of dust or dirt	1) Visual or auditory inspection 2) Retighten. 3), 4), 5) Visual inspection	1), 2), 3), 4), 5) No abnormalities
Main circuit	Common	1) Retighten. 2), 3) Visual inspection	1), 2), 3) No abnormalities
	Conductors and wires	1), 2) Visual inspection	1), 2) No abnormalities
	Terminal blocks	Visual inspection	No abnormalities
	DC link bus capacitor	1), 2) Visual inspection 3) Measure the discharge time with a capacitance probe.	1), 2) No abnormalities 3) The discharge time should not be shorter than the one specified by the replacement manual.
	Transformer and reactor	Auditory, visual, and olfactory inspection	No abnormalities
Control circuit	Printed circuit board	1) Retighten. 2) Olfactory and visual inspection 3), 4) Visual inspection	1), 2), 3), 4) No abnormalities

Table 10.1 List of Periodic Inspections (Continued)

Check part	Check item	How to inspect	Evaluation criteria	
Cooling system	Cooling fan	1) Check for abnormal noise and excessive vibration. 2) Check for loose bolts. 3) Check for discoloration caused by overheat.	1) Auditory and visual inspection, or turn manually (be sure to shut down the power beforehand). 2) Retighten. 3) Visual inspection	1) Smooth rotation 2), 3) No abnormalities
	Ventilation path	Check the heat sink, intake and exhaust ports for clogging and foreign materials.	Visual inspection	No abnormalities

Remove dust accumulating on the inverter with a vacuum cleaner. If the inverter is stained, wipe it off with a chemically neutral cloth.

10.3 List of Periodic Replacement Parts

The inverter consists of many electronic parts including semiconductor devices. Table 10.2 lists replacement parts that should be periodically replaced for preventive maintenance (Use the lifetime judgment function as a guide). These parts are likely to deteriorate with age due to their constitution and properties, leading to the decreased performance or failure of the inverter.

When the replacement is necessary, consult your Fuji Electric representative.

Table 10.2 Replacement Parts

Part name	Standard replacement intervals (See Note below.)	
	NEMA/UL TYPE1 NEMA/UL TYPE12 FRN001AR1■-2U to FRN060AR1■-2U FRN001AR1■-4U to FRN125AR1■-4U FRN001AR1■-5U to FRN150AR1■-5U	UL open type FRN075AR1S-2U to FRN125AR1S-2U FRN150AR1S-4U to FRN1000AR1S-4U FRN200AR1S-5U to FRN300AR1S-5U
DC link bus capacitor	5 years	10 years
Electrolytic capacitors on printed circuit boards	5 years	10 years
Cooling fan	5 years	10 years
Fuse	-	10 years

(Note) These replacement intervals are based on the inverter's service life estimated at an ambient temperature of 30°C (86°F) (NEMA/UL TYPE 12) or 40°C (104°F) (NEMA/UL open type, NEMA/UL TYPE 1) at full load (100% of the inverter rated current). In an environment with an ambient temperature above 30°C (86°F) (NEMA/UL TYPE 12) or 40°C (104°F) (NEMA/UL open type, NEMA/UL TYPE 1) or with a large amount of dust or dirt, or in an environment where inverters are mounted closely side by side, the replacement intervals may be shorter.

Standard replacement intervals mentioned above are only a guide for replacement, not a guaranteed service life.

10.3.1 Judgment on service life

The inverter has the life prediction function for some parts which measures the discharging time or counts the voltage applied time, etc. The function allows you to monitor the current lifetime state on the LCD monitor and judge whether those parts are approaching the end of their service life.

The life prediction function can also issue early warning signals if the life time alarm command **LIFE** is assigned to any of the digital output terminals. (Refer to "[3] Early warning of lifetime alarm" later in this section.)

Table 10.3 lists the parts whose service life can be predicted and details the life prediction function. The predicted values should be used only as a guide since the actual service life is influenced by the ambient temperature and other usage environments.

Table 10.3 Life Prediction

Object of life prediction	Prediction function	End-of-life criteria	Prediction timing	On the LCD monitor
DC link bus capacitor	Measurement of discharging time Measures the discharging time of the DC link bus capacitor when the main power is shut down and calculates the capacitance.	85% or lower of the initial capacitance at shipment (See "[1] Measuring the capacitance of the DC link bus capacitor in comparison with initial one at shipment" on the next page.)	At periodic inspection (H98: Bit 3 = 0)	3. INV Info >4. Maintenance >Main Capacitor Cap (Capacitance)
		85% or lower of the reference capacitance under ordinary operating conditions at the user site (See "[2] Measuring the capacitance of the DC link bus capacitor under ordinary operating conditions" on page 10-6.)	During ordinary operation (H98: Bit 3 = 1)	
	ON-time counting Counts the time elapsed when the voltage is applied to the DC link bus capacitor, while correcting it according to the capacitance measured above.	Exceeding 43,500 hours (5 years) For 230 V class series inverters of 75 HP or above, 460 V ones of 150 HP or above and 575V ones of 200HP or above: Exceeding 87,000 hours (10 years)	During ordinary operation	3. INV Info >4. Maintenance >Main Capacitor EneT (Elapsed time) RemT (Time remaining before the end of life)
Electrolytic capacitors on printed circuit boards	Counts the time elapsed when the voltage is applied to the capacitors, while correcting it according to the ambient temperature.	Exceeding 43,500 hours (5 years) For 230 V class series inverters of 75 HP or above, 460 V ones of 150 HP or above and 575V ones of 200HP or above: Exceeding 87,000 hours (10 years)	During ordinary operation	3. INV Info >4. Maintenance >PCB Capacitor EneT (Cumulative run time) Life (Lifetime estimated)
Cooling fan	Counts the run time of the cooling fan.	Exceeding 43,500 hours (5 years) For 230 V class series inverters of 75 HP or above, 460 V ones of 150 HP or above and 575V ones of 200HP or above: Exceeding 87,000 hours (10 years)	During ordinary operation	3. INV Info >4. Maintenance >Cooling Fan EneT (Cumulative run time) Life (Lifetime estimated)

The service life of the DC link bus capacitor can be judged by the "measurement of discharging time" or "ON-time counting."

Measurement of discharging time of the DC link bus capacitor

- The discharging time of the DC link bus capacitor depends largely on the inverter's internal load conditions, e.g. options attached or ON/OFF of digital I/O signals. If actual load conditions are so different from the ones at which the initial/reference capacitance is measured that the measurement result falls out of the accuracy level required, then the inverter does not perform measuring.
- The capacitance measuring conditions at shipment are drastically restricted, e.g., all input terminals being OFF in order to stabilize the load and measure the capacitance accurately. Those conditions are, therefore, different from the actual operating conditions in almost all cases. If the actual operating conditions are the same as those at shipment, shutting down the inverter power automatically measures the discharging time; however, if they are different, no automatic measurement is performed. To perform it, revert those conditions to the factory default ones and shut down the inverter. For the measuring procedure, see [1] given below.
- To measure the capacitance of the DC link bus capacitor under ordinary operating conditions when the power is turned OFF, it is necessary to set up the load conditions for ordinary operation and measure the reference capacitance (initial setting) when the inverter is introduced. For the reference capacitance setup procedure, see [2] on the next page. Performing the setup procedure automatically detects and saves the measuring conditions of the DC link bus capacitor.

Setting bit 3 of H98 data to 0 restores the inverter to the measurement in comparison with the initial capacitance measured at shipment.

Note When the inverter uses an auxiliary control power input, the load conditions widely differ so that the discharging time cannot be accurately measured. In this case, measuring of the discharging time can be disabled with the function code H98 (Bit 4 = 0) for preventing unintended measuring.

ON-time counting of DC link bus capacitor

- In a machine system where the inverter main power is rarely shut down, the inverter does not measure the discharging time. For such an inverter, the ON-time counting is provided. The ON-time counting result can be represented as "Elapsed time" (EneT) and "Time remaining before the end of life" (RemT) as shown in Table 10.3, "On the LCD monitor" column.

[1] Measuring the capacitance of the DC link bus capacitor in comparison with initial one at shipment

When bit 3 of H98 data is 0, the measuring procedure given below measures the capacitance of DC link bus capacitor in comparison with initial one at shipment when the power is turned OFF. The measuring result can be displayed on the keypad as a ratio (%) to the initial capacitance.

----- Capacitance measuring procedure -----

- 1) To ensure validity in the comparative measurement, revert the inverter condition back to the default at factory shipment.
 - Remove the option card (if already in use) from the inverter.
 - In case another inverter is connected via the DC link bus to the P(+) and N(-) terminals of the main circuit, disconnect the wires.
 - Disconnect power wires for the auxiliary input to the control circuit (R0, T0).
 - Turn OFF all the digital input signals on control circuit terminals [FWD], [REV], and [X1] through [X7]. (Signals on terminals [EN1] and [EN2] can be either ON or OFF.)
 - If an external frequency command potentiometer is connected to terminal [13] or [V2], disconnect it.
 - If an external apparatus is attached to terminal [PLC], disconnect it.

- Ensure that transistor output signals ([Y1] to [Y4]) and relay output signals ([Y5A/C] and [30A/B/C]) will not be turned ON.
- Disable the RS-485 communications link.

Note If negative logic is specified for the transistor output and relay output signals, they are considered ON when the inverter is not running. Specify positive logic for them.

- Keep the ambient temperature within $25 \pm 10^{\circ}\text{C}$ ($77 \pm 18^{\circ}\text{F}$).

- 2) Turn ON the main circuit power.
- 3) Confirm that the cooling fan is rotating and the inverter is in stopped state.
- 4) Turn OFF the main circuit power.
- 5) The inverter automatically starts the measurement of the capacitance of the DC link bus capacitor. Make sure that the LCD monitor shows the measuring status ("Before measurement" → "Measurement in progress" → "Measurement completed").

Note If no measuring status indication appears on the LCD monitor, measurement has not started. Check the conditions listed in 1).
- 6) After the measuring status indication has disappeared from the LCD monitor, turn ON the main circuit power again.
- 7) Switch to Programming mode, `PRG > 3(INV Info) > 4(Maintenance)` and note the reading (relative capacitance (%)) of the DC link bus capacitor). Refer to Chapter 5, Section 5.6.4.4 "Maintenance Information."

[2] Measuring the capacitance of the DC link bus capacitor under ordinary operating conditions

When bit 3 of H98 data is 1, the inverter automatically measures the capacitance of the DC link bus capacitor under ordinary operating conditions when the power is turned OFF. This measurement requires setting up the load conditions for ordinary operation and measuring the reference capacitance when the inverter is introduced to the practical operation, using the setup procedure given below

----- Reference capacitance setup procedure -----

- 1) Set function code H98 (Protection/maintenance function) to allow the user to specify the judgment criteria for the service life of the DC link bus capacitor (Bit 3 = 1).
- 2) Turn OFF all run commands.
- 3) Make the inverter ready to be turned OFF under ordinary operating conditions.
- 4) Set both function codes H42 (Capacitance of DC link bus capacitor) and H47 (Initial capacitance of DC link bus capacitor) to "0000."
- 5) Turn OFF the inverter, and the following operations are automatically performed.

The inverter measures the discharging time of the DC link bus capacitor and saves the result in function code H47 (Initial capacitance of DC link bus capacitor).

The conditions under which the measurement has been conducted will be automatically collected and saved.

- 6) Turn ON the inverter again.

Confirm that H42 (Capacitance of DC link bus capacitor) and H47 (Initial capacitance of DC link bus capacitor) hold right values. Switch to Programming mode, `PRG > 3(INV Info) > 4(Maintenance)` and confirm that the relative capacitance (ratio to full capacitance) is 100%.

Note If the measurement has failed, "0001" is entered into both H42 and H47. Remove the factor of the failure and conduct the measurement again.

Hereafter, each time the inverter is turned OFF, it automatically measures the discharging time of the DC link bus capacitor if the above conditions are met. Periodically check the relative capacitance of the DC link bus capacitor (%) with `[PRG > 3(INV Info) > 4(Maintenance)]` in Programming mode.

Note The condition given above produces a rather large measurement error. If this mode gives you a lifetime alarm, set H98 (Maintenance operation) back to the default setting (Bit 3 (Select life judgment threshold of DC link bus capacitor) = 0) and conduct the measurement under the condition at the time of factory shipment.

[3] Early warning of lifetime alarm

For the components listed in Table 10.3, the inverter can issue an early warning of lifetime alarm **LIFE** at one of the transistor output terminals ([Y1] to [Y4]) and the relay contact terminals ([Y5A/5C], and [30A/B/C]) as soon as any of the levels specified in Table 10.3 has been exceeded.

The early warning signal is also turned ON when a lock condition on the internal air circulation DC fan is detected.

10.4 Measurement of Electrical Amounts in Main Circuit





Because the voltage and current of the power supply (input, primary circuit) of the inverter main circuit and those of the motor (output, secondary circuit) contain harmonic components, the readings may vary with the type of the meter. Use meters listed in Table 10.4 when measuring with meters designed for commercial frequencies.

The power factor cannot be measured by a commercially available power-factor meter that measures the phase difference between the voltage and current. To obtain the power factor, measure the power, voltage and current on each of the input and output sides and use the following formula.

■ Three-phase input

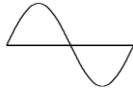
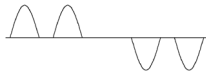
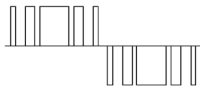
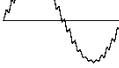
$$\text{Power factor} = \frac{\text{Electric power (W)}}{\sqrt{3} \times \text{Voltage (V)} \times \text{Current (A)}} \times 100\%$$

Table 10.4 Meters for Measurement of Main Circuit

Item	Input (primary) side			Output (secondary) side			DC link bus voltage (P(+)-N(-))
Waveform	Voltage 	Current 		Voltage 	Current 		
Name of meter	Ammeter AR, AS, AT	Voltmeter VR, VS, VT	Wattmeter WR, WT	Ammeter AU, AV, AW	Voltmeter VU, VV, VW	Wattmeter WU, WW	DC voltmeter V
Type of meter	Moving iron type	Rectifier or moving iron type	Digital AC power meter	Digital AC power meter	Digital AC power meter	Digital AC power meter	Moving coil type
Symbol of meter			—	—	—	—	

Note It is not recommended that meters other than a digital AC power meter be used for measuring the output voltage or output current since they may cause larger measurement errors or, in the worst case, they may be damaged.

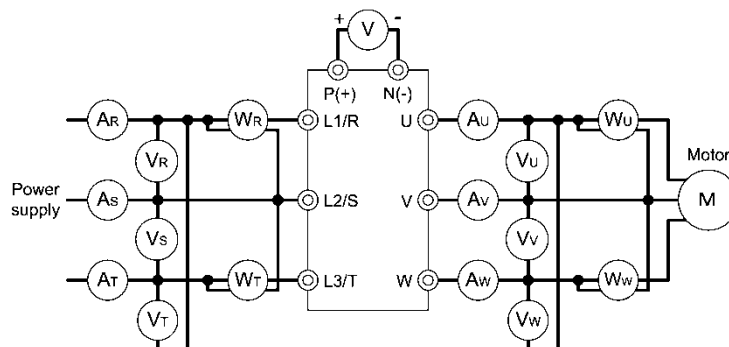

Figure 10.1 Connection of Meters

10.5 Insulation Test

Since the inverter has undergone an insulation test before shipment, avoid making a Megger test at the customer's site.

If a Megger test is unavoidable for the main circuit, observe the following instructions; otherwise, the inverter may be damaged. Even after the test, be careful with an electrical shock since an electrical charge may remain.

A withstand voltage test may also damage the inverter if the test procedure is wrong. When the withstand voltage test is necessary, consult your Fuji Electric representative.

(1) Megger test of main circuit

- 1) Use a 500 VDC Megger (*1) and shut off the main power supply without fail before measurement.
- 2) If the test voltage leaks to the control circuit due to the wiring, disconnect all the wiring from the control circuit.
- 3) Connect the main circuit terminals with a common line as shown in Figure 10.2.
- 4) The Megger test must be limited to across the common line of the main circuit and the ground (⊕).
- 5) Value of 5 MΩ or more displayed on the Megger indicates a correct state. (The value is measured on an inverter alone.)

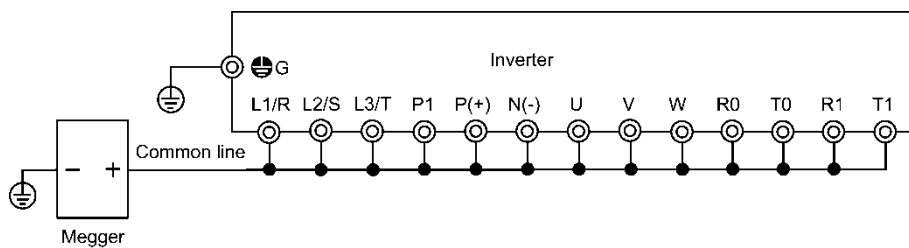

Figure 10.2 Main Circuit Terminal Connection for Megger Test

(2) Insulation test of control circuit

Do not make a Megger test or withstand voltage test for the control circuit. Use a high resistance range tester for the control circuit.

- 1) Disconnect all the external wiring from the control circuit terminals.
- 2) Perform a continuity test to the ground. One MΩ or a larger measurement indicates a correct state.

(3) Insulation test of external main circuit and sequence control circuit

Disconnect all the wiring connected to the inverter so that the test voltage is not applied to the inverter.

(*1): A 1000 VDC Mega can be used with the 575V class series.

10.6 Cooling Fan Replacement Procedure

FRN001AR1■-2U to FRN025AR1■-2U and FRN001AR1■-4U/5U to FRN050AR1■-4U/5U

⚠ CAUTION ⚠

Shut down the main power and auxiliary control power input of the inverter.

An accident or electric shock could occur.

(1) Wait for the cooling fan to stop.

Press inwards either one of the hooks provided on both sides of the fan casing at the upper section of the inverter and gently lift the fan cover up and off.

See a) and b) shown at the right.

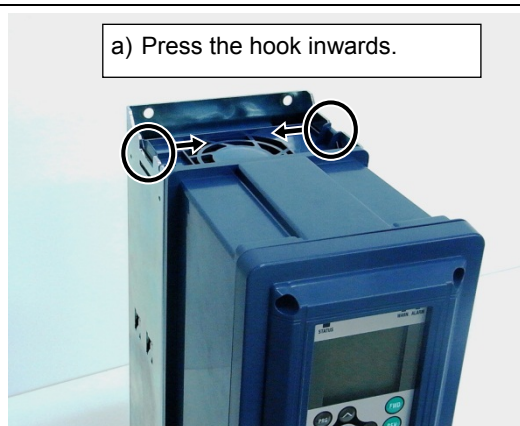

(2) Disconnect the cooling fan cable from the connector.

See c).

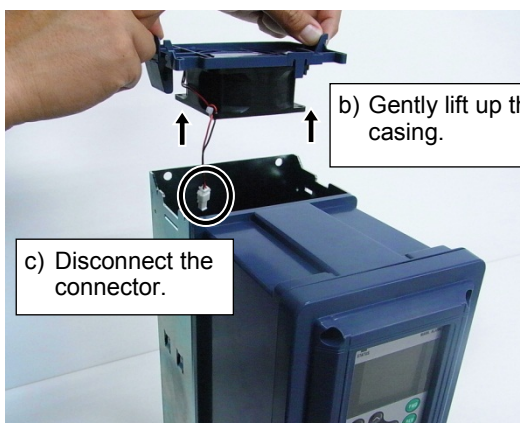

(3) Remove the cooling fan from its casing.

See d).

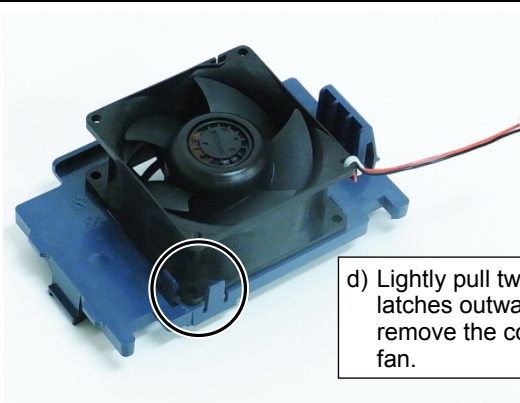

(4) Set a new cooling fan on the fan casing.

(5) Connect the cooling fan cable to the connector.

(6) Mount the fan casing on the inverter.

(7) Check that the cooling fan connector and cable do not interfere with the cooling fan unit or fan casing.

(8) Turn ON the main power. If H06 = 1, change the data to "0" and check that the cooling fan works normally.

FRN030AR1■-2U, FRN040AR1■-2U, FRN060AR1■-4U, and FRN075AR1■-4U

FRN060AR1■-5U, and FRN075AR1■-5U

⚠ CAUTION ⚠

Shut down the main power and auxiliary control power input of the inverter.
An accident or electric shock could occur.

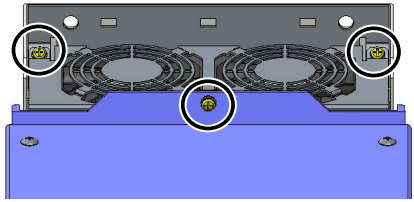
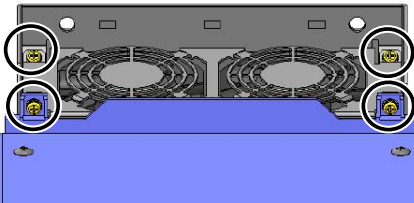
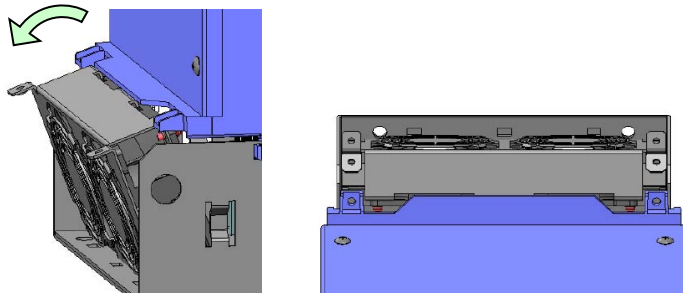
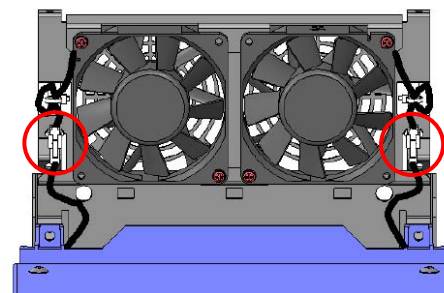
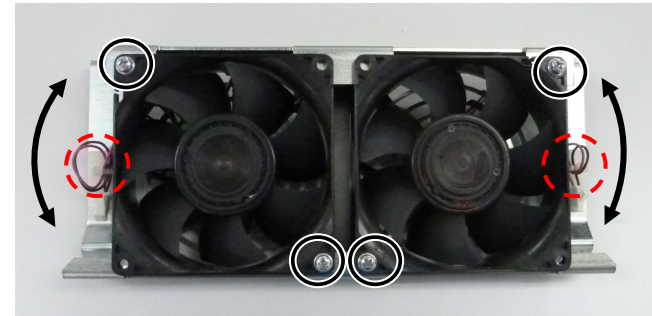
<p>(1) Remove the screws fixing the fans. ※Numbers of the screws are different depending on the shipment time. Please work comparing the actual product with the figures in right.</p>	<p style="text-align: center;">< Please remove the three screws. ></p>  <p style="text-align: center;">< Please remove the four screws. ></p> 
<p>(2) Turn the fan casing in the direction of the arrow and pull it towards you.</p>	
<p>(3) Disconnect the right and left connectors.</p>	
<p>(4) Remove four screws and cut the cable ties. Rotate the fans to the direction shown with arrows and remove the fans from fan case.</p>	

-
- (5) Set a new cooling fan on the fan casing.
 - (6) Connect the cooling fan cables.
 - (7) Mount the fan casing on the inverter.
 - (8) Check that the cooling fan connectors and cables do not interfere with the cooling fan unit or fan casing.
 - (9) Turn ON the main power. If H06 = 1, change the data to "0" and check that the cooling fans work normally.

FRN050AR1■-2U, FRN060AR1■-2U, FRN100AR1■-4U and FRN125AR1■-4U

FRN100AR1■-5U to FRN150AR1■-5U

⚠ CAUTION ⚠

Shut down the main power and auxiliary control power input of the inverter.
An accident or electric shock could occur.

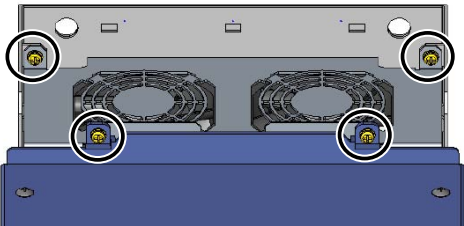
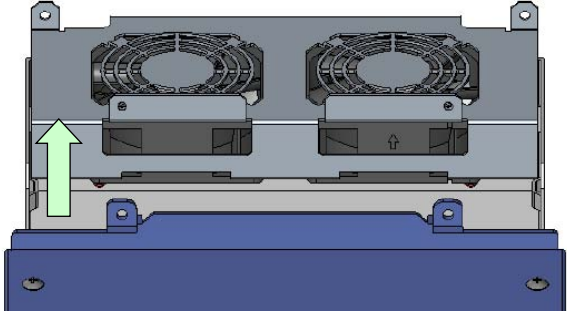
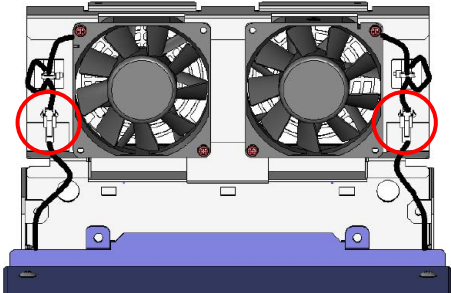
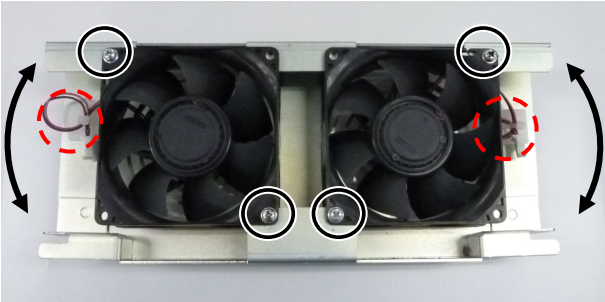
<p>(1) Remove the screws fixing the fans. ※Numbers of the screws are different depending on the shipment time. Please work comparing the actual product with the figures in right.</p>	<p>< Please remove the three screws .></p>  <p>< Please remove the four screws .></p> 
<p>(2) Pull out the fan casing in the direction of the arrow.</p>	
<p>(3) Disconnect the right and left connectors.</p>	
<p>(4) Remove four screws and cut the cable ties. Rotate the fans to the direction shown with arrows and remove the fans from fan case.</p>	

- (5) Set a new cooling fan on the fan casing.
- (6) Connect the cooling fan cables.
- (7) Mount the fan casing on the inverter.
- (8) Check that the cooling fan connectors and cables do not interfere with the cooling fan unit or fan casing.
- (9) Turn ON the main power. If H06 = 1, change the data to "0" and check that the cooling fans work normally.

Replacing the internal fans

- (1) Remove the inverter front panel and disconnect the two fan power connectors.

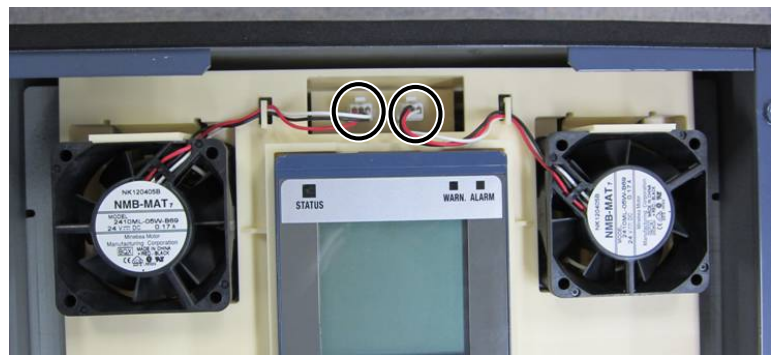

- (2) Pull the latches securing the fans in the direction of the arrows and remove the fans.

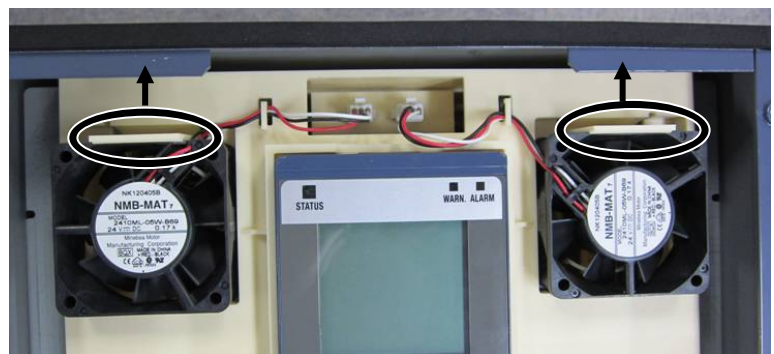

- (3) Mount the internal fans in the reverse order of removal.

FRN075AR1S-2U and FRN100AR1S-2U

⚠ CAUTION ⚠

Shut down the main power and auxiliary control power input of the inverter.

An accident or electric shock could occur.

- (1) Loosen the four mounting screws on the front cover, slide the cover in the direction of the arrow, and remove it towards you.

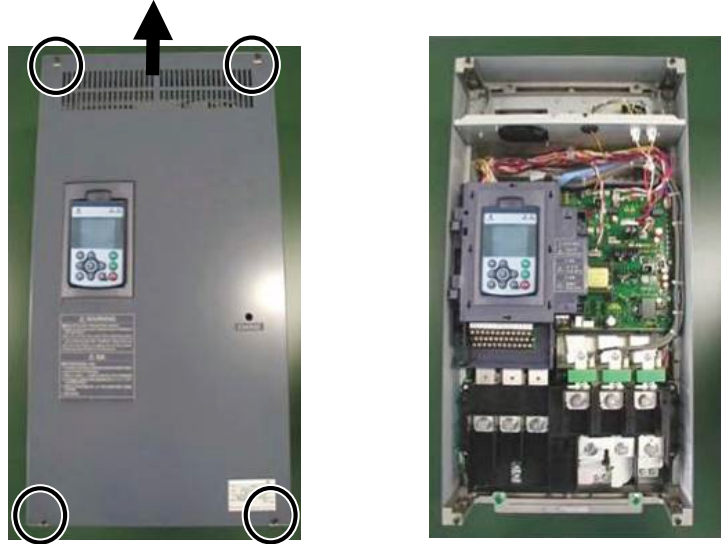

- (2) Disconnect the three fan power connectors marked with ellipses. Remove the eight screws circled.

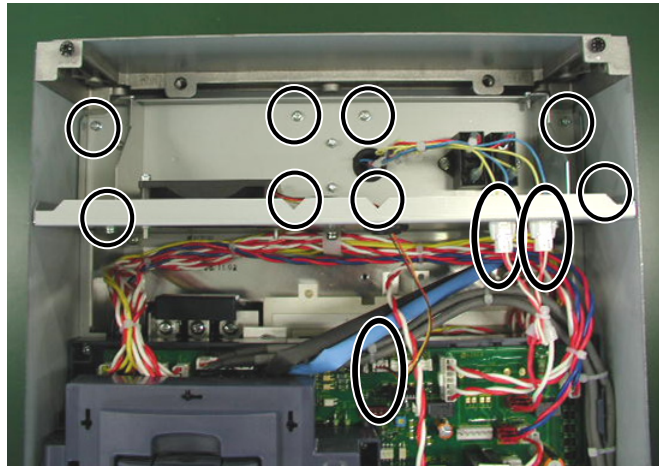

- (3) Hold the grip and pull out the fan unit towards you.

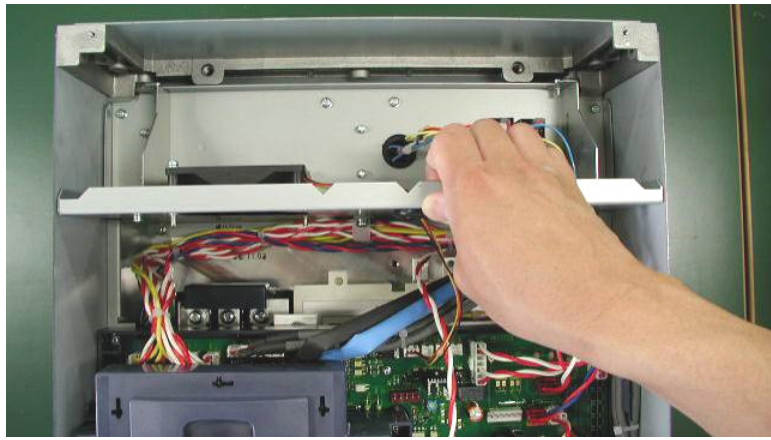

(4) The photo given at the right shows the fan unit removed.



(5) Remove the fans from the fan unit using the procedure given below.

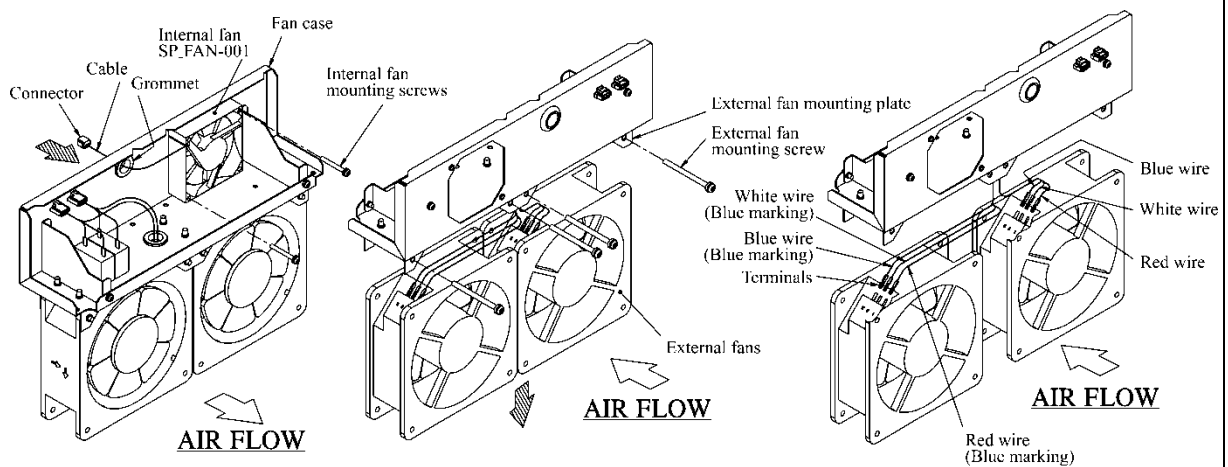

- ① Pull out the cable and connector through the grommet in the direction of the arrow. Remove the two internal fan mounting screws, then take the internal fan out of the mounting plate.
- ② Remove the four external fan mounting screws (2 screws per fan). Slide the external fans in the direction of the arrow and remove them from the external fan mounting plate.
- ③ Disconnect the six terminals (3 terminals per fan) from the external fans and remove the fans.

To mount new fans, reverse the removal procedure.
 Note: Be careful with the air flow direction and cable routing.
 Note: Fully insert the terminals with long-nose pliers.

FRN125AR1S-2U, FRN150AR1S-4U to FRN1000AR1S-4U , FRN200AR1S-5U to FRN300AR1S-5U

(taking FRN300AR1S-4U as an illustration example)

⚠ CAUTION ⚠

Shut down the main power, auxiliary control power, and auxiliary fan power inputs of the inverter.
An accident or electric shock could occur.

(1) Loosen the mounting screws on the upper front cover, slide the cover in the direction of the arrow, and remove it toward you.

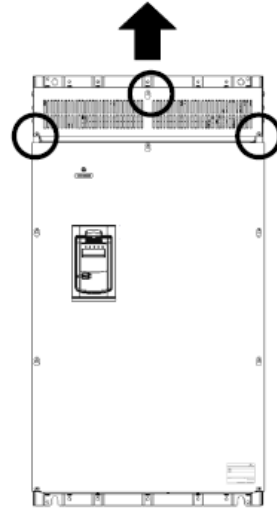

(2) Disconnect the fan power connector.

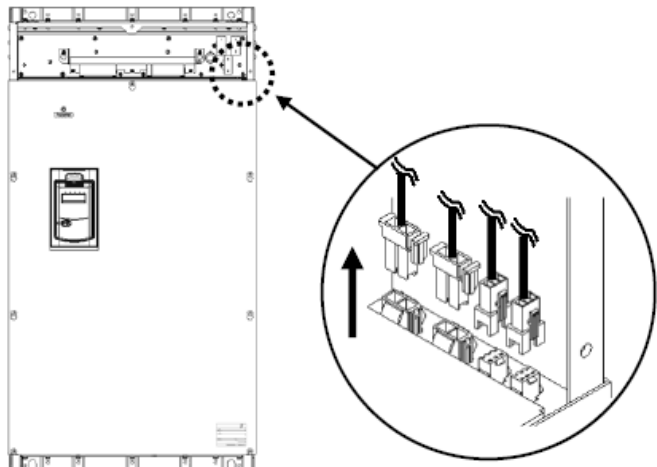

(3) Remove the fan unit mounting screws and pull out the fan unit towards you.

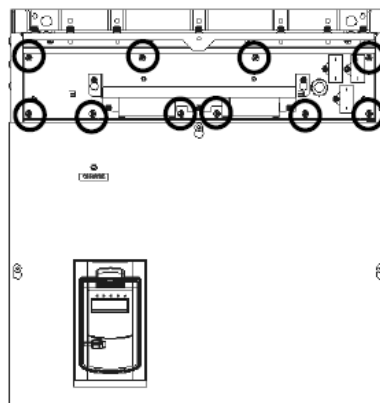

(4) The figure given at the right shows the removed fan unit.

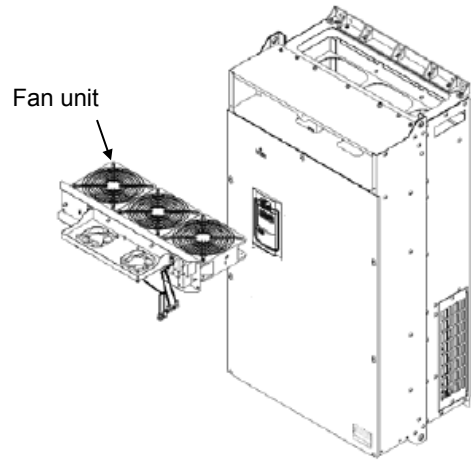

(5) Cut off the cable ties (InsuLock) securing the internal fan cables.
Remove the internal fan mounting screws and take the internal fans off the internal fan mounting plate.

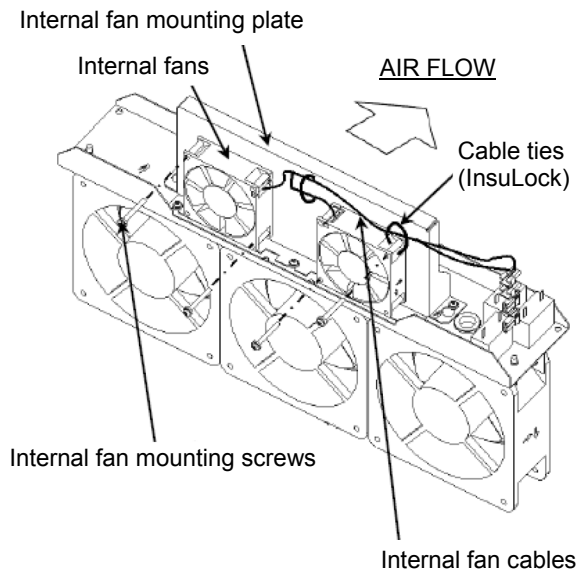

(6) For inverters of 300 to 450 and 800 HP:
Disconnect the terminals from the fan capacitors.

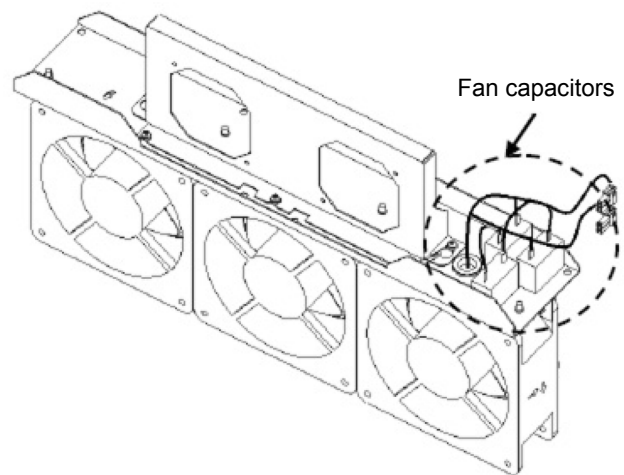

(7) For inverters of 300 to 450 and 800 HP:
Remove the capacitor mounting screws from the fan capacitors and take the capacitors off the fan casing.

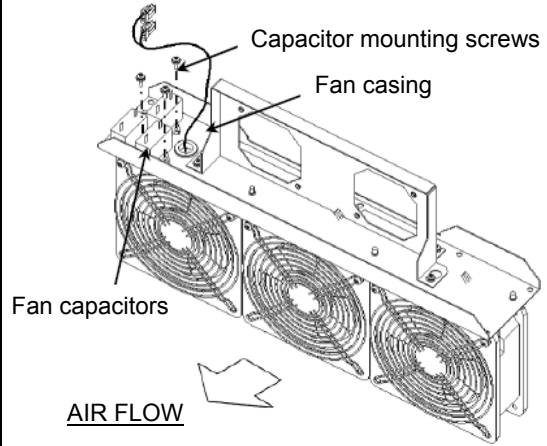

(8) Remove the external fan mounting screws.

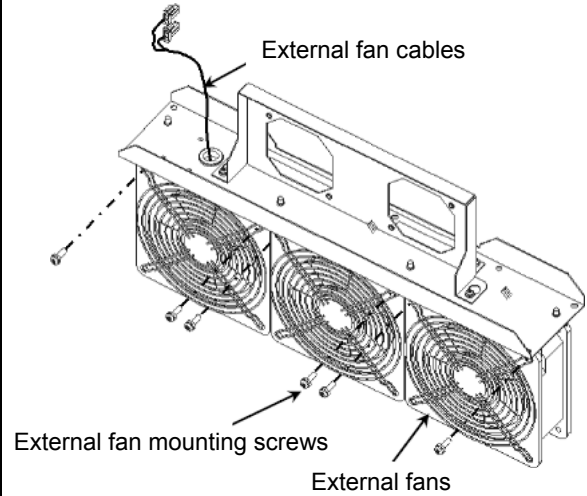

(9) Lift up the external fan mounting plate and disconnect the fan connectors.

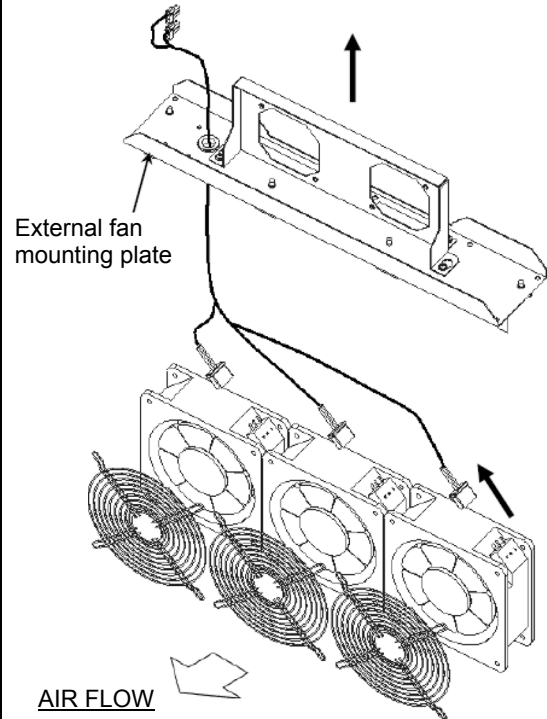

- (10) After the removal of fans, mount new fans in the reverse order of removal.
- (11) Secure the cables with cable ties (InsuLock) near the fans as they were.
- (12) Check that the cooling fan connectors and cables do not interfere with the cooling fans or fan casing.
- (13) Turn ON the main power. If H06 = 1, change the data to "0" and check that the cooling fans work normally.

Chapter 11

CONFORMITY WITH STANDARDS

This chapter sets forth the conformity with overseas standards.

Contents

11.1	Compliance with European Standards	11-1
11.1.1	Conformity to the Low Voltage Directive in the EU	11-3
11.1.2	Compliance with EMC Standards	11-1
11.1.2.1	General	11-1
11.1.2.2	Recommended installation procedure	11-1
11.1.2.3	Leakage current of the EMC filter	11-3
11.1.3	Harmonic Component Regulation in the EU	11-8
11.1.3.1	General	11-8
11.1.3.2	Compliance with IEC/EN 61000-3-2	11-8
11.1.3.3	Compliance with IEC/EN 61000-3-12	11-8
11.1.4	Functional Safety Function description	11-9
11.1.4.1	General	11-9
11.1.4.2	Notes for compliance to Functional Safety Standard	11-10
11.1.4.3	EN ISO13849-1 PL=d	11-11
11.1.4.4	Inverter output state when Safe Torque Off (STO) is activated	11-11
11.1.4.5	ECF alarm (caused by logic discrepancy) and inverter output state	11-12
11.1.4.6	Prevention of restarting	11-13
11.2	Conformity with UL Standards and cUL-listed for Canada	11-14
11.2.1	General	11-14
11.2.2	Conformity with UL standards and cUL-listed for Canada	11-14

11.1 Compliance with European Standards

The CE marking on Fuji products indicates that they comply with the essential requirements of the Electromagnetic Compatibility (EMC) Directive and Low Voltage Directive which are issued by the Council of the European Communities.

Inverters of all capacities have a built-in EMC filter as standard. For 230 V class series inverters of 75 HP or above and 460/575 V ones of 150 HP or above, installing an EMC-compliant filter at the power supply side externally upgrades the emission category of the EMC Directive from C3 to C2.

Lone inverters comply with the following standards

Inverter Type	FRN001AR1■-2U to FRN060AR1■-2U FRN001AR1■-4U to FRN125AR1■-4U	FRN075AR1S-2U to FRN125AR1S-2U FRN150AR1S-4U to FRN1000AR1S-4U FRN001AR1■-5U to FRN150AR1■-5U FRN200AR1S-5U to FRN300AR1S-5U
Low Voltage Directive	IEC/EN 61800-5-1	
EMC Directive	IEC/EN 61800-3	
	Immunity	Second environment (Industrial)
	Emission	Category C2
		Category C3

Inverter Type	FRN001AR1■-2U to FRN025AR1■-2U FRN001AR1■-4U to FRN050AR1■-4U *1	FRN030AR1■-2U to FRN060AR1■-2U FRN075AR1S-2U to FRN125AR1S-2U FRN060AR1■-4U to FRN125AR1■-4U FRN150AR1S-4U to FRN1000AR1S-4U *2
Functional Safety	IEC/EN 61800-5-2 SIL 2, EN ISO 13849-1	
	Stop function	Safe torque off (STO: according to EN61800-5-2)
	Response time	50 ms or less (delay time to "Safe torque off" from turning off either terminal [EN1] or [EN2])
	Safety integrity level	SIL 2
	Safety related subsystem	Type B
	Hardware Fault Tolerance	HFT 1
	PFH	3.15E-9 (Probability of a dangerous random hardware failure per hour)
	DC	≥ 60%
	SFF	≥ 60%
	Proof test interval	20 years
	Category	Cat 3 (EN ISO 13849-1)
	Stop function	Safe torque off (STO: according to EN61800-5-2)
	Performance level	d (EN ISO 13849-1)

Note *1)About target models, products are conformable to functional safety from product ver. "N□" or later.

*2)About target models, products are conformable to functional safety from product ver. "NI" or later.

"Product ver." described in above note, means the alphabet symbol of SER.NO.'s last two letters.

The last letter means hardware version, and the second letter means software version.

□: This means any hardware version is available.

Inverters combined with a separate EMC-compliant filter comply with the following standards

Inverter Type	FRN075AR1S-2U to FRN125AR1S-2U FRN150AR1S-4U to FRN450AR1S-4U	FRN500AR1S-4U to FRN1000AR1S-4U	
EMC-compliant filter	FS, FN series (option)		
Low Voltage Directive	IEC/EN 61800-5-1		
EMC Directive	IEC/EN 61800-3		
	Immunity	Second environment (Industrial)	
	Emission	Category C2	Category C3

11.1.1 Conformity to the Low Voltage Directive in the EU

If installed according to the guidelines given below, inverters marked with CE are considered as compliant with the Low Voltage Directive.

Compliance with European Standards

Adjustable speed electrical power drive systems (PDS).

Part 5-1: Safety requirements. Electrical, thermal and energy. IEC/EN 61800-5-1

1. The ground terminal \ominus G should always be connected to the ground. Do not use only a residual-current-operated protective device (RCD)/earth leakage circuit breaker (ELCB)* as the sole method of electric shock protection. Be sure to use ground wires of recommended size listed Table 11.1.

*With overcurrent protection.

2. To prevent the risk of hazardous accidents that could be caused by damage of the inverter, install the specified fuses in the supply side (primary side) according to the following tables.

- Breaking capacity: Min. 10 kA
- Rated voltage: Min. 500 V

Power supply voltage	Nominal applied motor (HP)	Inverter type	Fuse rating (A)	Power supply voltage	Nominal applied motor (HP)	Inverter type	Fuse rating (A)
Three-phase 230 V	1	FRN001AR1■-2U	6 (IEC/EN 60269-2)	Three-phase 460 V	1	FRN001AR1■-4U	4 (IEC/EN 60269-2)
	2	FRN002AR1■-2U	10 (IEC/EN 60269-2)		2	FRN002AR1■-4U	6 (IEC/EN 60269-2)
	3	FRN003AR1■-2U	16 (IEC/EN 60269-2)		3	FRN003AR1■-4U	10 (IEC/EN 60269-2)
	5	FRN005AR1■-2U	25 (IEC/EN 60269-2)		5	FRN005AR1■-4U	16 (IEC/EN 60269-2)
	7.5	FRN007AR1■-2U	35 (IEC/EN 60269-2)		7.5	FRN007AR1■-4U	20 (IEC/EN 60269-2)
	10	FRN010AR1■-2U	50 (IEC/EN 60269-2)		10	FRN010AR1■-4U	25 (IEC/EN 60269-2)
	15	FRN015AR1■-2U	80 (IEC/EN 60269-2)		15	FRN015AR1■-4U	35 (IEC/EN 60269-2)
	20	FRN020AR1■-2U	100 (IEC/EN 60269-2)		20	FRN020AR1■-4U	50 (IEC/EN 60269-2)
	25	FRN025AR1■-2U	125 (IEC/EN 60269-2)		25	FRN025AR1■-4U	63 (IEC/EN 60269-2)
	30	FRN030AR1■-2U	250 (IEC60269-4)		30	FRN030AR1■-4U	80 (IEC/EN 60269-2)
	40	FRN040AR1■-2U			40	FRN040AR1■-4U	100 (IEC/EN 60269-2)
	50	FRN050AR1■-2U	350 (IEC60269-4)		50	FRN050AR1■-4U	125 (IEC/EN 60269-2)
	60	FRN060AR1■-2U			60	FRN060AR1■-4U	250 (IEC60269-4)
	75	FRN075AR1S-2U	450 (IEC60269-4)		75	FRN075AR1■-4U	
100	FRN100AR1S-2U	500 (IEC60269-4)	100	FRN100AR1■-4U	350 (IEC60269-4)		
125	FRN125AR1S-2U		125	FRN125AR1■-4U			
			150	FRN150AR1S-4U			
			200	FRN200AR1S-4U	400 (IEC60269-4)		
			250	FRN250AR1S-4U	450 (IEC60269-4)		
			300	FRN300AR1S-4U	500 (IEC60269-4)		
			350	FRN350AR1S-4U	550 (IEC60269-4)		
			450	FRN450AR1S-4U	630 (IEC60269-4)		
			500	FRN500AR1S-4U	900 (IEC60269-4)		
			600	FRN600AR1S-4U	1250 (IEC60269-4)		
			800	FRN800AR1S-4U			
			900	FRN900AR1S-4U	2000 (IEC60269-4)		
			1000	FRN1000AR1S-4U			

The diagram shows a three-phase power supply entering from the left. It passes through a disconnect device (MCCB or RCD/ELCB, etc.) and a main circuit breaker (MC). After the MC, there are fuses for each phase. The lines then connect to the motor terminals: L1/R, L2/S, and L3/T. Additionally, there are terminals for R0, T0, R1, and T1, which are connected to the motor's ground/neutral point.

FRENIC-HVAC

Note: A box (■) replaces an alphabetic letter depending on the enclosure. M (NEMA/UL TYPE 1) or L (NEMA/UL TYPE 12)

(continue)

Power supply voltage	Nominal applied motor (HP)	Inverter type	Fuse rating (A)	Power supply voltage	Nominal applied motor (HP)	Inverter type	Fuse rating (A)
Three-phase 575 V	1	FRN001AR1■-5U	3(IEC/EN 60269-2)	Three-phase 575 V	40	FRN040AR1■-5U	80(IEC/EN 60269-2)
	2	FRN002AR1■-5U	4(IEC/EN 60269-2)		50	FRN050AR1■-5U	100(IEC/EN 60269-2)
	3	FRN003AR1■-5U	6(IEC/EN 60269-2)		60	FRN060AR1■-5U	250(IEC 60269-4)
	5	FRN005AR1■-5U	10(IEC/EN 60269-2)		75	FRN075AR1■-5U	250(IEC 60269-4)
	7.5	FRN007AR1■-5U	16(IEC/EN 60269-2)		100	FRN100AR1■-5U	250(IEC 60269-4)
	10	FRN010AR1■-5U	20(IEC/EN 60269-2)		125	FRN125AR1■-5U	350(IEC 60269-4)
	15	FRN015AR1■-5U	25(IEC/EN 60269-2)		150	FRN150AR1■-5U	350(IEC 60269-4)
	20	FRN020AR1■-5U	35(IEC/EN 60269-2)		200	FRN200AR1S-5U	400(IEC 60269-4)
	25	FRN025AR1■-5U	50(IEC/EN 60269-2)		250	FRN250AR1S-5U	450(IEC 60269-4)
	30	FRN030AR1■-5U	63(IEC/EN 60269-2)		300	FRN300AR1S-5U	500(IEC 60269-4)

Note: A box (■) replaces an alphabetic letter depending on the enclosure. M (NEMA/UL TYPE 1) or L (NEMA/UL TYPE 12)

3. When used with the inverter, a molded case circuit breaker (MCCB), residual-current-operated protective device (RCD)/earth leakage circuit breaker (ELCB) or magnetic contactor (MC) should conform to the EN or IEC standards.
4. When you use a residual-current-operated protective device (RCD)/earth leakage circuit breaker (ELCB) for protection from electric shock in direct or indirect contact power lines or nodes, be sure to install type B of RCD/ELCB on the input (primary) of the inverter.
5. The inverter should be used in an environment that does not exceed Pollution Degree 2 requirements.
6. Install the inverter, AC reactor (ACR), input or output filter in an enclosure with minimum degree of protection of IP2X (Top surface of enclosure shall be minimum IP4X when it can be easily accessed), to prevent human body from touching directly to live parts of these equipment.
7. Do not connect any copper wire directly to grounding terminals. Use crimp terminals with tin or equivalent plating to connect them.
8. When you use an inverter at an altitude of more than 6600 ft (2000 m), you should apply basic insulation for the control circuits of the inverter. The inverter cannot be used at altitudes of more than 9800 ft (3000 m).

9. Use wires listed in IEC 60364-5-52.

Table 11.1 Recommended Wire Sizes

Power supply voltage	Nominal applied motor (HP)	Inverter type	Recommended wire size (mm ²)						
			Main terminal			DC reactor [P1, P(+)] *1	Control circuit	Aux. control power supply [R0, T0]	Aux. main circuit power supply [R1, T1]
			Main power input		Inverter outputs [U, V, W] *1				
			[L1/R, L2/S, L3/T] *1	Inverter's grounding [EG] *1					
Three-phase 230 V	1	FRN001AR1■-2U	2.5	10	2.5	DCR built-in	0.75	2.5	-
	2	FRN002AR1■-2U							
	3	FRN003AR1■-2U							
	5	FRN005AR1■-2U							
	7.5	FRN007AR1■-2U			4				
	10	FRN010AR1■-2U	4	6					
	15	FRN015AR1■-2U	10		10				
	20	FRN020AR1■-2U	25		16				
	25	FRN025AR1■-2U			25				
	30	FRN030AR1■-2U			35				
	40	FRN040AR1■-2U	50		50				
	50	FRN050AR1■-2U	70		70				
	60	FRN060AR1■-2U	95		95				
	75	FRN075AR1S-2U	50×2	95	70×2				
100	FRN100AR1S-2U	95×2	95	95×2	120×2				
125	FRN125AR1S-2U	120×2	120	120×2	150×2				

*1 The recommended wire size for main circuits is for the 70°C (158°F) 600 V PVC wires used at an ambient temperature of 40°C (104°F).

Note: A box (■) replaces an alphabetic letter depending on the enclosure.
M (NEMA/UL TYPE 1) or L (NEMA/UL TYPE 12)

Table 11.1 Recommended Wire Sizes (continued)

Power supply voltage	Nominal applied motor (HP)	Inverter type	Recommended wire size (mm ²)															
			Main terminal			DC reactor [P1, P(+)] *1	Control circuit	Aux. control power supply [R0, T0]	Aux. main circuit power supply [R1, T1]									
			Main power input		Inverter outputs [U, V, W] *1													
			[L1/R, L2/S, L3/T] *1	Inverter's grounding [EG] *1														
Three-phase 460 V	1	FRN001AR1■-4U	2.5	10	2.5	DCR built-in	0.75	2.5	-									
	2	FRN002AR1■-4U			4					6								
	3	FRN003AR1■-4U									6	10						
	5	FRN005AR1■-4U											10	16				
	7.5	FRN007AR1■-4U													25	25		
	10	FRN010AR1■-4U															35	50
	15	FRN015AR1■-4U																
	20	FRN020AR1■-4U	95	95														
	25	FRN025AR1■-4U			50×2					95	70×2	95×2						
	30	FRN030AR1■-4U	70×2	95									240	300				
	40	FRN040AR1■-4U			185				95	240×2	300×2							
	50	FRN050AR1■-4U	300	150								300	150×2					
	60	FRN060AR1■-4U			185×2				185	240×2	300×2							
	75	FRN075AR1■-4U	300×2	300								300×2	300×3					
	100	FRN100AR1■-4U			240×3				185×2	240×3	300×3							
	125	FRN125AR1■-4U	300×3	240×2								240×4	300×4					
	150	FRN150AR1S-4U			300×4				300×2	300×4	300×4							
	200	FRN200AR1S-4U	300×4	300×2								300×4	300×4					
	250	FRN250AR1S-4U			300×4				300×2	300×4	300×4							
	300	FRN300AR1S-4U	300×4	300×2								300×4	300×4					
350	FRN350AR1S-4U	300×4			300×2	300×4	300×4											
450	FRN450AR1S-4U		300×4	300×2				300×4	300×4									
500	FRN500AR1S-4U	300×4			300×2	300×4	300×4											
600	FRN600AR1S-4U		300×4	300×2				300×4	300×4									
800	FRN800AR1S-4U	300×4			300×2	300×4	300×4											
900	FRN900AR1S-4U		300×4	300×2				300×4	300×4									
1000	FRN1000AR1S-4U	300×4			300×2	300×4	300×4											

*1 The recommended wire size for main circuits is for the 70°C (158°F) 600 V PVC wires used at an ambient temperature of 40°C(104°F).

Note: A box (■) replaces an alphabetic letter depending on the enclosure.
M (NEMA/UL TYPE 1) or L (NEMA/UL TYPE 12)

Table 11.1 Recommended Wire Sizes (continued)

Power supply voltage	Nominal applied motor (HP)	Inverter type	Recommended wire size (mm ²)						
			Main terminal			DC reactor [P1, P(+)] ^{*1}	Control circuit	Aux. control power supply [R0, T0]	Aux. main circuit power supply [R1, T1]
			Main power input		Inverter outputs [U, V, W] ^{*1}				
			[L1/R, L2/S, L3/T] ^{*1}	Inverter's grounding [EG] ^{*1}					
Three-phase 575 V	1	FRN001AR1■-5U	2.5	10	2.5	DCR built-in	0.75	2.5	-
	2	FRN002AR1■-5U							
	3	FRN003AR1■-5U							
	5	FRN005AR1■-5U							
	7.5	FRN007AR1■-5U							
	10	FRN010AR1■-5U							
	15	FRN015AR1■-5U	4						
	20	FRN020AR1■-5U		6					
	25	FRN025AR1■-5U		10					
	30	FRN030AR1■-5U	10	16					
	40	FRN040AR1■-5U	25		25				
	50	FRN050AR1■-5U			35				
	60	FRN060AR1■-5U		35	50				
	75	FRN075AR1■-5U	70		70				
	100	FRN100AR1■-5U	70		70				
	125	FRN125AR1■-5U	95	95	95				
	150	FRN150AR1■-5U							
	200	FRN200AR1S-5U							
250	FRN250AR1S-5U	150	95	120	185	240			
300	FRN300AR1S-5U	185							

*1 The recommended wire size for main circuits is for the 70°C (158°F) 600 V PVC wires used at an ambient temperature of 40°C(104°F).

Note: A box (■) replaces an alphabetic letter depending on the enclosure.
M (NEMA/UL TYPE 1) or L (NEMA/UL TYPE 12)

10. The inverter has been tested with IEC/EN 61800-5-1 Short-circuit Test under the following conditions.

Short-circuit current in the supply: 10,000 A

240V or below (200V class series inverters of 18.5 kW (25HP) or below.)

230V or below (230V class series inverters of 22 kW (30HP) or above.)

480V or below (480V class series inverters)

600V or below (575V class series inverters)

11. Use this inverter at the following power supply system.

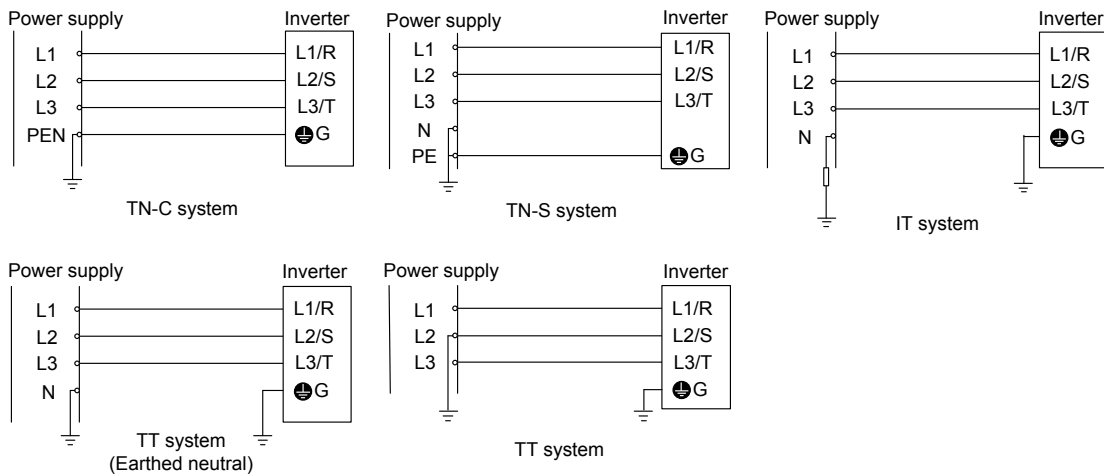

200V type inverters can be used at IT or TT system.
Use 400V type inverters at the following IT or TT system.

*1) EMC filter : on

Earthed condition	Can or cannot be used and caution
Non-earthed (isolated from earth) IT system	Available.
IT system which earthed neutral by an impedance	In this case the insulation between the control interface and the main circuit of the inverter is basic insulation. Thus do not connect SELV circuit from external controller directly (make connection using a supplementary insulation.) Use an earth fault detector able to disconnect the power within 5 s after the earth fault occurs.
Corner earthed / Phase-earthed system by an impedance or earthed system of 400V(TT system)	Not available.

*2) EMC filter : off

Earthed condition	Can or cannot be used and caution	note *3)
Non-earthed (isolated from earth) IT system	Available. Restrict the input voltage at 440V+10%	All models of 400V series product. 150HP or bigger models of product ver. earlier "G" : Use an earth fault detector able to disconnect the power within 5 s after the earth fault occurs.
IT system which earthed neutral by an impedance	In this case the insulation between the control interface and the main circuit of the inverter is basic insulation. Thus do not connect SELV circuit from external controller directly (make connection using a supplementary insulation.)	
Corner earthed / Phase-earthed system by an impedance or earthed system of 400V(TT system)	Available. Restrict the input voltage at 440V+10%	125HP or smaller models of 400V series product. 150HP or bigger models of product ver. later "H"
	Not available.	150HP or bigger models of product ver. earlier "G"

*1,2)According to chapter 11.1.2.3 of User's manual, turn the EMC filter off.
*3)"product ver." described in note Colum, means the alphabet symbol of SER.NO.'s end.

Use 575V type inverters at the following IT or TT system.

Earthed condition	Can or cannot be used and caution
Non-earthed (isolated from earth) IT system	Available.
IT system which earthed neutral by an impedance	In this case the insulation between the control interface and the main circuit of the inverter is basic insulation. Thus do not connect SELV circuit from external controller directly (make connection using a supplementary insulation.) Use an earth fault detector able to disconnect the power within 5 s after the earth fault occurs.
Corner earthed / Phase-earthed system by an impedance or earthed system of 575V(TT system)	Not available.

11.1.2 Compliance with EMC Standards

11.1.2.1 General

The CE marking on inverters does not ensure that the entire equipment including our CE-marked products is compliant with the EMC Directive. Therefore, CE marking for the equipment shall be the responsibility of the equipment manufacturer. For this reason, Fuji's CE mark is indicated under the condition that the product shall be used within equipment meeting all requirements for the relevant Directives. Instrumentation of such equipment shall be the responsibility of the equipment manufacturer.

Generally, machinery or equipment includes not only our products but other devices as well. Manufacturers, therefore, shall design the whole system to be compliant with the relevant Directives.

Tip Our EMC compliance test is performed with the following wiring length (of the shielded cable) between the inverter and motor under the specified inverter usage conditions.

• FRN001AR1■-2U to FRN060AR1■-2U	: 75 m (246 ft)
• FRN075AR1S-2U to FRN125AR1S-2U (Lone inverter)	: 10 m (33 ft)
• FRN075AR1S-2U to FRN125AR1S-2U (Combined with filter)	: 20 m (66 ft)
• FRN001AR1■-4U to FRN125AR1■-4U	: 75 m (246 ft)
• FRN150AR1S-4U to FRN1000AR1S-4U (Lone inverter)	: 10 m (33 ft)
• FRN150AR1S-4U to FRN1000AR1S-4U (Combined with filter)	: 20 m (66 ft)
• FRN001AR1■-5U to FRN150AR1■-5U	: 75 m (246 ft)
• FRN200AR1S-5U to FRN300AR1S-5U (Lone inverter)	: 10 m (33 ft)

11.1.2.2 Recommended installation procedure

To make the machinery or equipment fully compliant with the EMC Directive, have certified technicians wire the motor and inverter in strict accordance with the procedure given below.

- 1) Use shielded wires for the motor cable and route the cable as short as possible. Firmly clamp the shield to the specified point or the grounded metal plate inside the inverter. Further, connect the shielding layer electrically to the grounding terminal of the motor.
- 2) FRN007AR1■-2U to FRN060AR1■-2U and FRN015AR1■-4U to FRN125AR1■-4U, be sure to pass the main circuit power input lines of the inverter through a ferrite core in wiring.

For 575V series, ferrite core is not required.

 For wiring of the inverter main circuit power input lines, refer to Chapter 5, Section 5.1.2.1 "(3) Wiring of main circuit power lines."

- 3) Connect the grounding wires to the grounding terminals without passing them through a ferrite core.

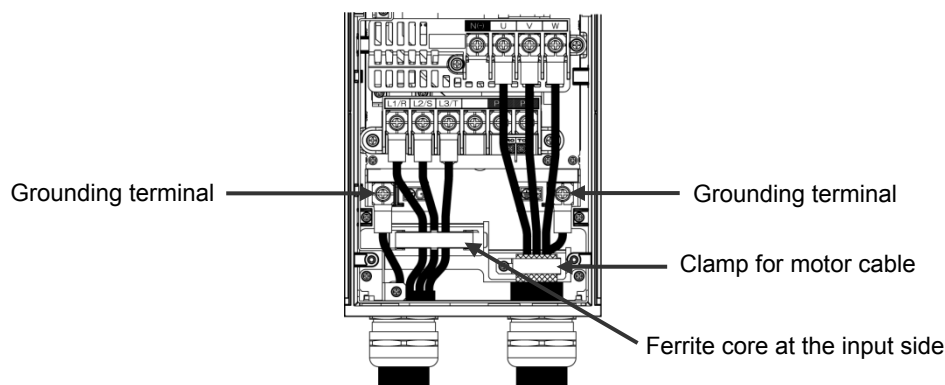

Figure 11.1 Wiring to Main Circuit Terminals

- 4) For connection to inverter's control terminals and for connection of the RS-485 communication signal cable, use shielded wires. As with the motor, clamp the shields firmly to the specified point or the grounded metal plate inside the inverter.

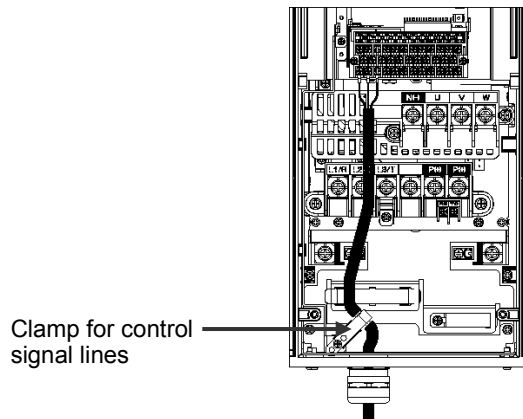

Figure 11.2 Wiring to Control Circuit Terminals

- 5) When connecting an EMC-compliant filter (option) to the inverter externally, mount the inverter and the filter on a grounded panel or metal plate as shown in Figure 11.2-1. If radiation noise from the inverter exceeds the permission level, enclose the inverter and its peripherals in a metal panel. For the combination of the inverter and the filter, see Table 11.2-1.

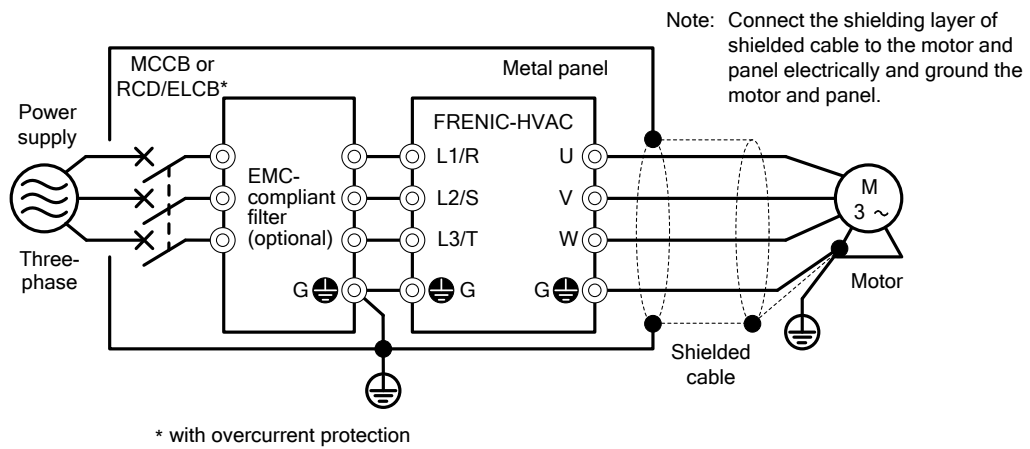

Figure 11.2-1 Mounting the Inverter with EMC-compliant Filter in a Metal Panel

11.1.2.3 Leakage current of the EMC filter

This product uses grounding capacitors for noise suppression which increase the leakage current. Check whether there is no problem with electrical systems.

Table 11.2 Leakage Current of Lone Inverter

Input power	Inverter type	Leakage current (mA)		Input power	Inverter type	Leakage current (mA)			
		Under normal conditions	Under worst-case conditions			Under normal conditions	Under worst-case conditions		
Three-phase 230 V *1	FRN001AR1■-2U	86	140	Three-phase 230 V *1	FRN025AR1■-2U	180	291		
	FRN002AR1■-2U				198	314			
	FRN003AR1■-2U								
	FRN005AR1■-2U								
	FRN007AR1■-2U	224	357		FRN050AR1■-2U	204	322		
	FRN010AR1■-2U								
	FRN015AR1■-2U								
	FRN020AR1■-2U				180	291			
Three-phase 460 V *2	FRN001AR1■-4U	55	164	Three-phase 460 V *2	FRN025AR1■-4U	148	440		
	FRN002AR1■-4U								
	FRN003AR1■-4U								
	FRN005AR1■-4U								
	FRN007AR1■-4U								
	FRN010AR1■-4U								
	FRN015AR1■-4U	135	417		FRN100AR1■-4U				
	FRN020AR1■-4U								
	FRN025AR1■-4U								
	FRN030AR1■-4U								
	FRN040AR1■-4U	111	381		FRN125AR1■-4U				
	FRN050AR1■-4U								
	FRN060AR1■-4U								
	FRN075AR1■-4U								
	Three-phase 460 V *2	FRN001AR1■-4U	119		367	Three-phase 460 V *2	FRN150AR1S-4U	3	34
		FRN002AR1■-4U							
FRN003AR1■-4U									
FRN005AR1■-4U									
FRN007AR1■-4U									
FRN010AR1■-4U									
FRN015AR1■-4U									
FRN020AR1■-4U									
FRN025AR1■-4U									
FRN030AR1■-4U									
FRN040AR1■-4U									
FRN050AR1■-4U									
FRN060AR1■-4U									
FRN075AR1■-4U									
FRN100AR1S-4U									
FRN125AR1S-4U									
FRN150AR1S-4U									
FRN200AR1S-4U									
FRN250AR1S-4U									
FRN300AR1S-4U									
FRN350AR1S-4U									
FRN450AR1S-4U									
FRN500AR1S-4U									
FRN600AR1S-4U									
FRN800AR1S-4U									
FRN900AR1S-4U									
FRN1000AR1S-4U									

*1 Calculated based on these measuring conditions: 200 V/ 50 Hz, grounding of a single wire in delta-connection, interphase voltage unbalance ratio 2%.

*2 Calculated based on these measuring conditions: 400 V/ 50 Hz, neutral grounding in Y-connection, interphase voltage unbalance ratio 2%.

Note The worst-case conditions include input phase loss.

Table 11.2 Leakage Current of Lone Inverter(continue)

Input power	Inverter type	Leakage current (mA)		Input power	Inverter type	Leakage current (mA)	
		Under normal conditions	Under worst-case conditions			Under normal conditions	Under worst-case conditions
Three-phase 575 V *3	FRN001AR1■-5U	68	119	Three-phase 575 V *3	FRN040AR1■-5U	56	149
	FRN002AR1■-5U				FRN050AR1■-5U		
	FRN003AR1■-5U				FRN060AR1■-5U	98	375
	FRN005AR1■-5U				FRN075AR1■-5U		
	FRN007AR1■-5U				FRN100AR1■-5U	108	393
	FRN010AR1■-5U	FRN125AR1■-5U					
	FRN015AR1■-5U	34	113		FRN150AR1S-5U	18	79
	FRN020AR1■-5U				FRN200AR1S-5U		
	FRN025AR1■-5U				FRN250AR1S-5U		
	FRN030AR1■-5U				FRN300AR1S-5U		

*3 Calculated based on these measuring conditions: 575 V/ 60 Hz, neutral grounding in Y-connection, interphase voltage unbalance ratio 2%.

Note The worst-case conditions include input phase loss.

Table 11.2-1 Leakage Current of EMC Filter

Input power	Inverter type	Filter type	Leakage current (mA)	
			Under the usage conditions of EMC-compliant filter	Under worst-case conditions
Three-phase 230V *1	FRN075AR1S-2U	FS5536-400-99-1	265	381
	FRN100AR1S-2U			
	FRN125AR1S-2U			
Three-phase 460 V *2	FRN150AR1S-4U	FS5536-250-99-1	59	364
	FRN200AR1S-4U			
	FRN250AR1S-4U	FS5536-400-99-1	78	439
	FRN300AR1S-4U			
	FRN350AR1S-4U			
	FRN450AR1S-4U	FN3359-600-99	38	227
	FRN500AR1S-4U	FN3359-800-99	38	227
	FRN600AR1S-4U			
	FRN800AR1S-4U	FN3359-1000-99	39	233
	FRN900AR1S-4U	FN3359-1600-99	38	227
FRN1000AR1S-4U				

*1 Calculated based on these measuring conditions: 200 V/ 50 Hz, grounding of a single wire in delta-connection, interphase voltage unbalance ratio 2%.

*2 Calculated based on these measuring conditions: 400 V/ 50 Hz, neutral grounding in Y-connection, interphase voltage unbalance ratio 2%.

Note The worst-case conditions include input phase loss.

Leakage current

A high frequency current component generated by insulated gate bipolar transistors (IGBTs) switching on/off inside the inverter becomes leakage current through stray capacitance of inverter input and output wires or a motor. If any of the problems listed below occurs, take an appropriate measure against them.

Problem	Measures
An earth leakage circuit breaker* that is connected to the input (primary) side has tripped. * With overcurrent protection	<ol style="list-style-type: none"> 1) Decrease the carrier frequency. 2) Make the wires between the inverter and motor shorter. 3) Use an earth leakage circuit breaker with lower sensitivity than the one currently used.
An external thermal relay was activated.	<ol style="list-style-type: none"> 1) Decrease the carrier frequency. 2) Increase the setting current of the thermal relay. 3) Use the electronic thermal overload protection built in the inverter, instead of the external thermal relay.

Note Usually there is no need to do anything for the EMC filter.

When the leakage current from the connected EMC filter causes problems with the power supply system, removing screws from terminals [E1] and [E2] could improve the problem. Note that doing so loses the effect of the EMC filter so that the inverter is no longer compliant with the EMC standards. To remove those screws, consult your Fuji Electric representative.

For the locations of terminals [E1] and [E2], see the arrangement of terminals given in Chapter 2, Section 2.3.3.1.

The 230 V class series inverters of 75 HP or above and 460 V ones of 150 HP or above have neither [E1] nor [E2]. Instead of [E1] and [E2], removing SW10 can get equivalent effect.

- FRN001AR1■-2U to FRN025AR1■-2U, FRN001AR1■-4U/5U to FRN050AR1■-4U/5U

Removing the screws from terminals [E1] and [E2] separates the grounding capacitors, decreasing the leakage current.

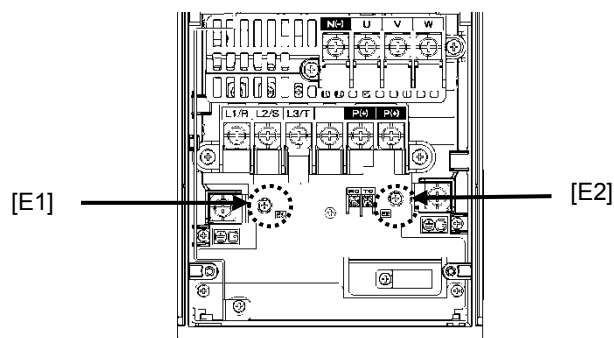

- FRN030AR1■-2U to FRN060AR1■-2U, FRN060AR1■-4U to FRN125AR1■-4U
FRN060AR1■-5U to FRN150AR1■-5U

Secure the filter grounding wires to the supports, using the screws removed from terminals [E1] and [E2].

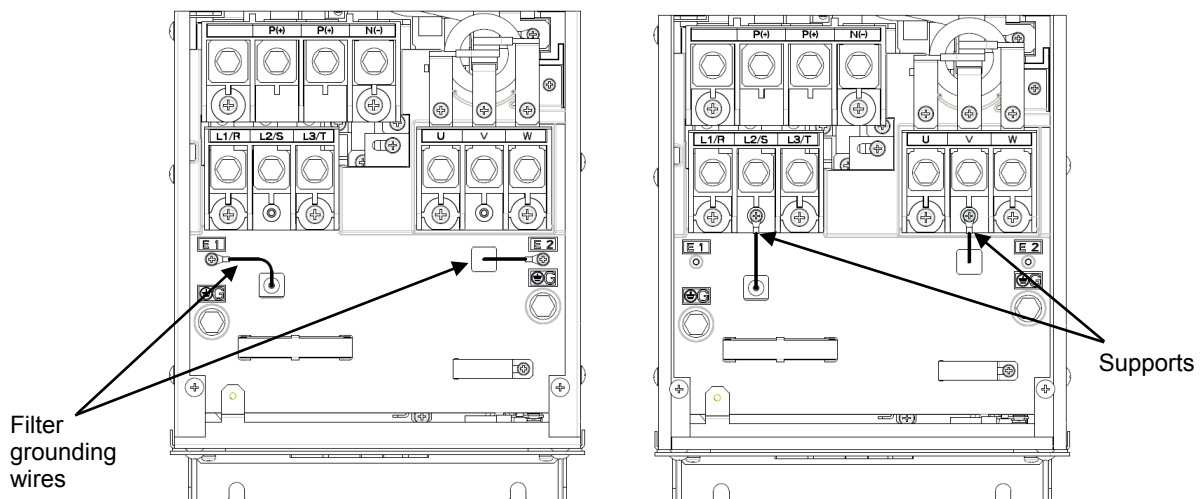

- FRN075AR1■-2U~FRN125AR1■-2U, FRN150AR1■-4U~FRN200AR1■-4U

Remove the connector SW10 (Red) and replace the connector to dummy one (White) attached in back side of key pad panel cover.

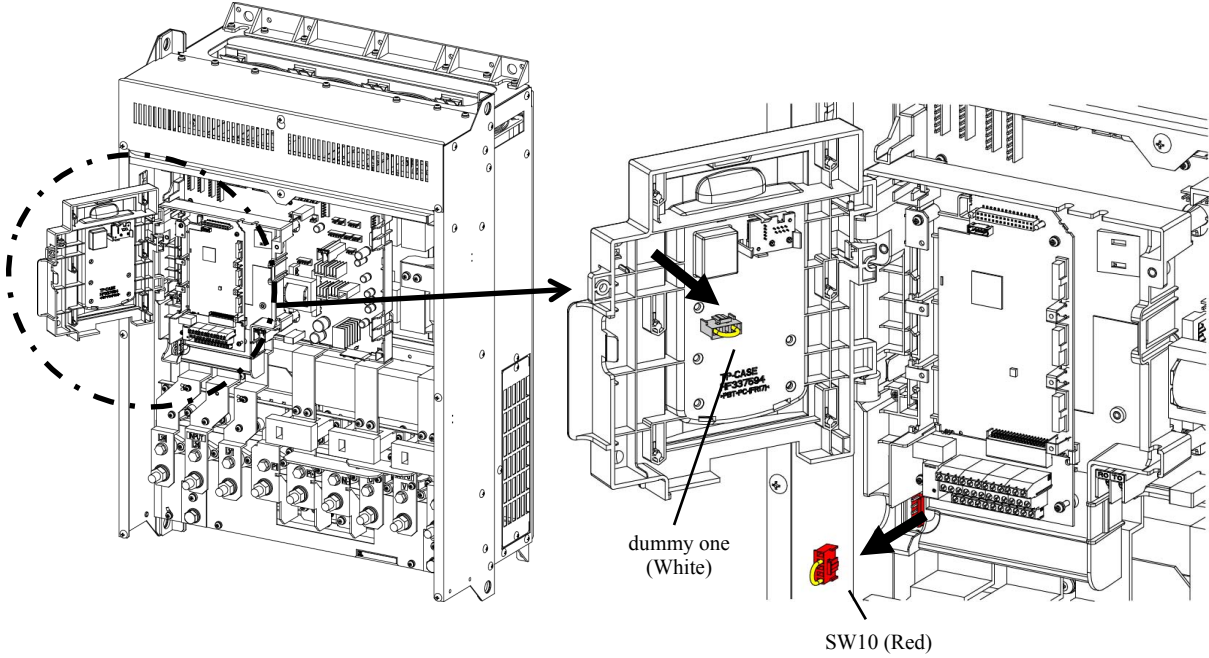

- FRN250AR1■-4U~FRN1000AR1■-4U

Remove the connector SW10 (Red) and replace the connector to dummy one (White) attached in back side of key pad panel cover.

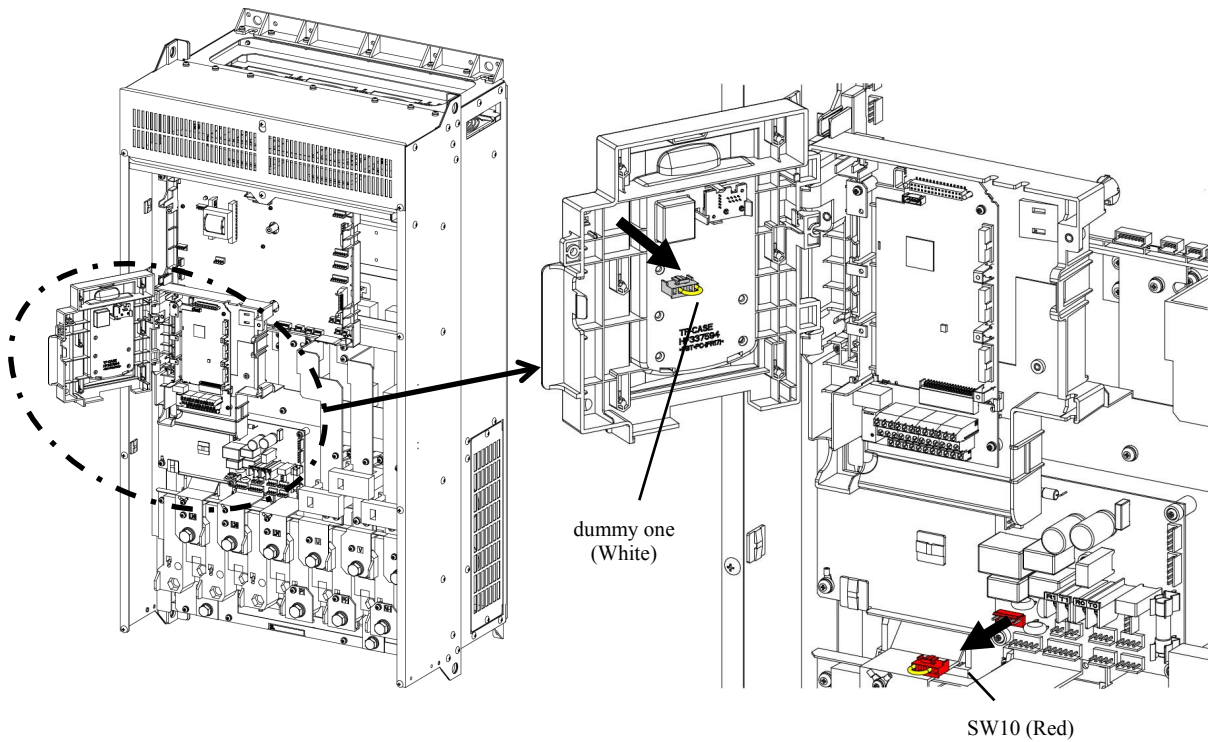

11.1.3 Harmonic Component Regulation in the EU

11.1.3.1 General

When general-purpose industrial inverters are used in the EU, the harmonics emitted from inverters to the power lines are strictly regulated as stated below.

If an inverter whose rated input is 1 kW or less is connected to the public low-voltage power supply, it is regulated by the harmonics emission regulation IEC/EN 61000-3-2. If an inverter whose input current is 16 A or above and 75 A or below is connected to the public low-voltage power supply, it is regulated by the harmonics emission regulation IEC/EN 61000-3-12.

Note that connection to the industrial low-voltage power lines is an exception. (See Figure 11.3.)

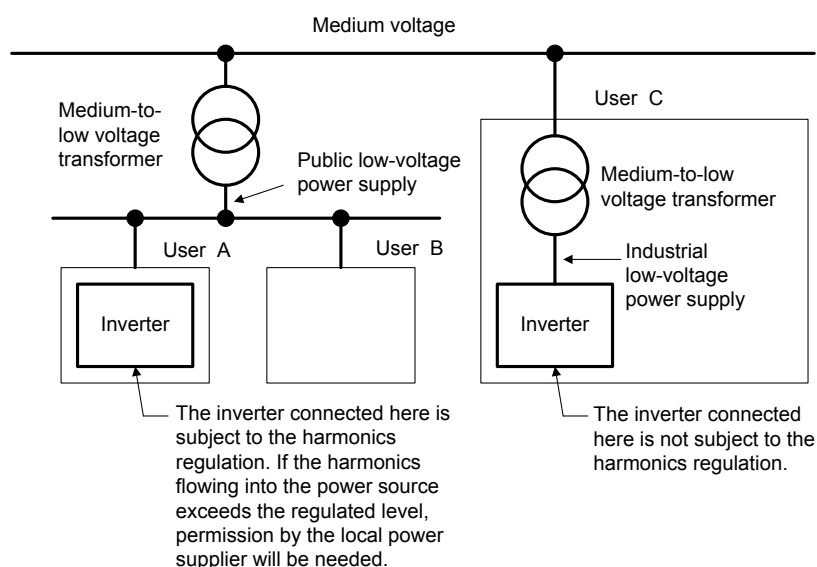

Figure 11.3 Power Source and Regulation

11.1.3.2 Compliance with IEC/EN 61000-3-2

The FRN001AR1■-4U satisfies the IEC/EN 61000-3-2, so it can be connected to the public low-voltage power supply.

11.1.3.3 Compliance with IEC/EN 61000-3-12

To bring the FRN001AR1■-2U to FRN025AR1■-2U and FRN001AR1■-4U to FRN050AR1■-4U and FRN001AR1■-5U to FRN060AR1■-5U into compliance with the IEC/EN 61000-3-12, connect them to the power supply whose short-circuit ratio R_{sce} is 120 or above.

11.1.4 Functional Safety Function description

11.1.4.1 General

In FRENIC-HVAC and FRENIC-AQUA series of inverters, opening the hardware circuit between terminals [EN1]-[PLC] or between terminals [EN2]-[PLC] stops the output transistor, coasting the motor to a stop (EN1: Enable input 1, EN2: Enable input 2). This is the Safe Torque Off (STO) function prescribed in EN60204-1, Category 0 (Uncontrolled stop) and compliant with Functional Safety Standard.

Using the Safe Torque Off (STO) function eliminates the need of external safety circuit breakers while conventional inverters need those breakers to configure the Functional Safety Standard compliant safety system.

⚠ WARNING ⚠

- The output shutdown function of this inverter uses the Safe Torque Off (STO) function prescribed in IEC61800-5-2 so that it does not completely shut off the power supply to the motor electrically. Depending upon applications, therefore, additional measures are necessary for safety of end-users, e.g., brake function that locks the machinery and motor terminal protection that prevents possible electrical hazard(s).
- The output shutdown function does not completely shut off the power supply to the motor electrically. Therefore, before starting wiring or maintenance jobs, be sure to disconnect the input power to the inverter and wait at least five minutes for inverters with a capacity of 22 kW of 400 V series and 11 kW of 200 V series or below, or at least ten minutes for inverters with a capacity of 30 kW of 400 V series and 15 kW of 200 V series or above.
- The functional safety function integrity is ensured only if the inverter is operating in an environment that satisfies the requirements described in the instruction manual (chapter 11.1.4.2).

Enable terminals and peripheral circuit, and internal circuit configuration

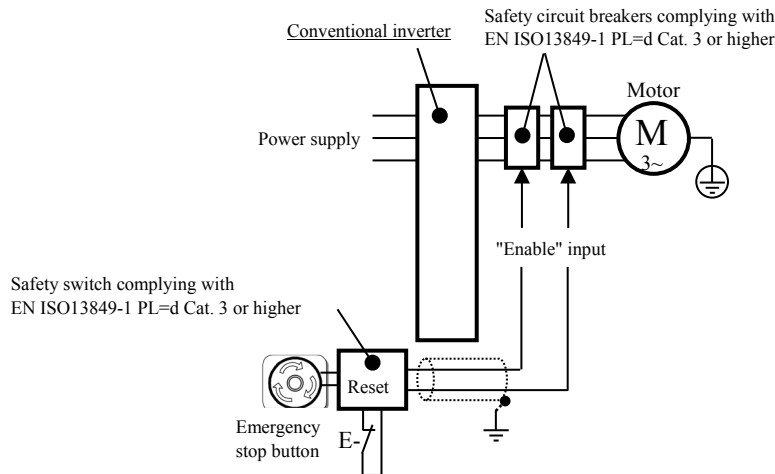
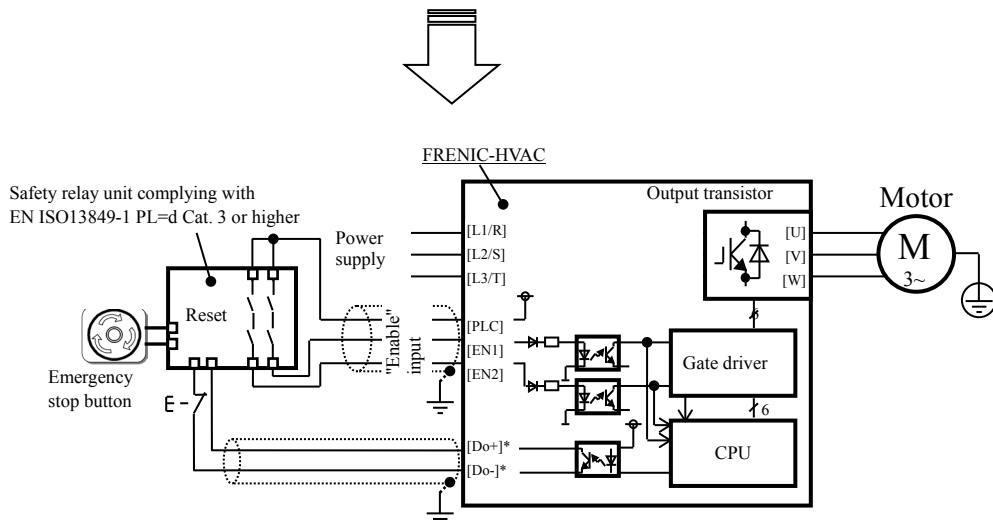

Figure 11.4 Conventional Inverters



*Transistor output terminals (e.g., [Y1]-[CMY], *DEC*F (Function code data=1101), Refer to Section 11.1.4.6)

Figure 11.5 FRN_ _ _AR1 ■-□U

11.1.4.2 Notes for compliance to Functional Safety Standard

1) Wiring for terminals [EN1] (Enable input 1) and [EN2] (Enable input 2)

- [EN1]/[EN2] and [PLC] are terminals prepared for connection of safety related wires; therefore, careful wiring should be performed to ensure that no short-circuit(s) can occur to these terminals.
- For opening and closing the hardware circuit between terminals [EN1]/[EN2] and [PLC], use safety approved components such as safety relays that comply with EN ISO13849-1 PL=d Cat. 3 or higher to ensure a complete shut off.
- It is the responsibility of the machinery manufacturer to guarantee that a short-circuiting or other fault does not occur in wiring of external safety components between terminals [EN1]/[EN2] and [PLC].

Fault examples:

- Terminals [EN1]/[EN2] and [PLC] are short-circuited due to the wiring being caught in the door of the control panel so that a current continues to flow in terminal [EN1]/[EN2] although the safety component is OFF and therefore the safety function may NOT operate.
- The wiring is in contact with any other wire so that a current continues to flow in terminal [EN1]/[EN2] and therefore the safety function may NOT operate.

2) Notes for Safe Torque Off (STO) functional safety function

- When configuring the product safety system with this Safe Torque Off (STO) function, make a risk assessment of not only the external equipment and wiring connected to terminals [EN1] and [EN2] (Enable input 1 and Enable input 2) but also the whole system including other equipment, devices and wiring, because it is required by the machine directive that the whole system conforms to the safety requirements under the machine manufacturer's responsibility.

In addition, as preventive maintenance, the machinery manufacturer must perform periodical inspections to check that the product safety system properly functions.

- The inverter has been designed according to pollution degree 2 requirements. Therefore, in order to bring the inverter into compliance with Functional Safety Standard, it is necessary to install the inverter on a control panel with the enclosure rating of IP54 or above.
- To bring the inverter into compliance with Functional Safety Standard, it is necessary to bring it into compliance with European Standards EN61800-5-1 and EN61800-3.
- This Safe Torque Off (STO) function coasts the motor to a stop. When a mechanical brake is used to stop or hold the motor for the sake of the product safety system of whole system, do not use the inverter's control signals such as output from terminal [Y]. Using control signals does not satisfy the safety standards because of software intervention. Use safety relay units complying with EN ISO13849-1 PL=d Cat.3 or higher to activate mechanical brakes.
- The safety shutdown circuit between terminal [EN1] and [EN2] input sections and inverter's output shutdown section is dual-configured (redundant circuit) so that an occurrence of a single fault does not detract the Safe Torque Off (STO).

If a single fault is detected in the safety shutdown circuit, the inverter coasts the motor to a stop even with the [EN1]-[PLC] and [EN2]-[PLC] states being ON, as well as outputting an alarm to external equipment. Note that the alarm output function is not guaranteed to all single faults. It is compliant with EN ISO13849-1 PL=d Cat. 3.

- The Safe Torque Off (STO) function does not completely shut off the power supply to the motor electrically. Before starting wiring or maintenance jobs, be sure to disconnect the input power to the inverter and wait at least 5 minutes.

3) Test of Safe Torque Off (STO) functional safety function

- In application where no regular activation of the Safe Torque Off (STO) function is guaranteed, check at least once a year that the Safe Torque Off (STO) function works correctly.

4) At power up

- At power up ensure that the terminals [EN1] and [EN2] are not short circuited to PLC (or +24VDC). This allows executing a diagnostic of the functional safety function circuit.

11.1.4.3 EN ISO13849-1 PL=d

European Standard EN ISO13849-1 PL=d (Safety of machinery–Safety related parts of control systems) prescribes the basic safety requirements for machinery categorized according to the requirement level. Category 3 represents the requirements that the machinery shall be designed with redundancy so that a single fault does not lead to the loss of the safety function. Table 11.3 shows an outline of the category levels and their safety requirements. For detailed requirements, refer to EN ISO13849-1 PL=d.

Table 11.3

Category	Summary of requirements	System behavior
B	SRP/CS and/or their protective equipment, as well as their components, shall be designed, constructed, selected, assembled and combined in accordance with relevant standards so that they can withstand the expected influences. Basic safety principles shall be used.	The occurrence of a fault can lead to the loss of the safety function.
1	Requirements of Category B shall apply. Well-tried components and well-tried safety principles shall be used.	The occurrence of a fault can lead to the loss of the safety function but the probability of occurrence is lower than for Category B.
2	Requirements of Category B and the use of well-tried safety principles shall apply. Safety function shall be checked at suitable intervals by the machine control system.	The occurrence of a fault can lead to the loss of the safety function between the checks. The loss of safety function is detected by the check.
3	Requirements of Category B and the use of well-tried safety principles shall apply. Safety-related parts shall be designed, so that - a single fault in any of these parts does not lead to the loss of the safety function, and - whenever reasonably practicable, the single fault is detected.	When a single fault occurs, the safety function is always performed. Some, but not all, faults will be detected. Accumulation of undetected faults can lead to the loss of the safety function.
4	Requirements of Category B and the use of well-tried safety principles shall apply. Safety-related parts shall be designed, so that - a single fault in any of these parts does not lead to a loss of the safety function, and - the single fault is detected at or before the next demand upon the safety function, but if this detection is not possible, an accumulation of undetected faults shall not lead to the loss of the safety function.	When a single fault occurs, the safety function is always performed. Detection of accumulated faults reduces the probability of the loss of the safety function (high DC). The faults will be detected in time to prevent the loss of the safety function.

11.1.4.4 Inverter output state when Safe Torque Off (STO) is activated

Turning the emergency stop button ON, switches OFF EN1 and EN2 inputs, bringing the inverter into the Safe Torque Off (STO). This activates a waiting time provided by the H16 parameter; this time can be modified using the standard keypad: AUTO (100 ms as default mode), from 0.0 (equivalent to 0.1s) to 30.0 seconds. Once the H16 waiting time has elapsed, the STO diagnosis is executed. The STO diagnosis requires less than one second to be completed.

Figure 11.6 shows the timing scheme to apply when the emergency stop button is turned OFF with the inverter being stopped. Input to the EN1 and EN2 comes ON, making the inverter ready to run.

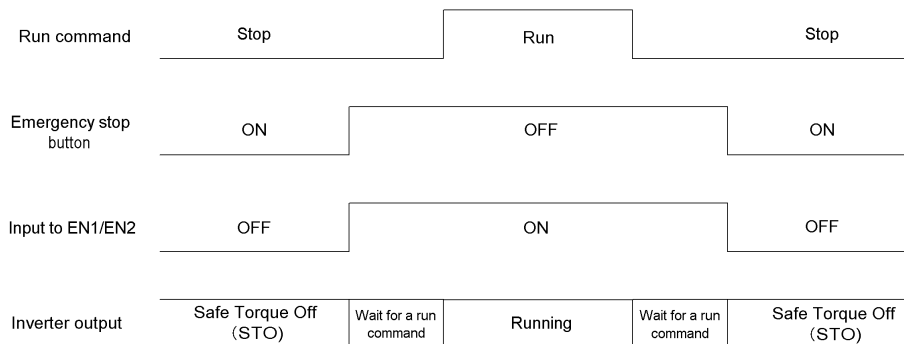

Figure 11.6 Inverter Output State when the Emergency Stop Button is Turned OFF with the Inverter being Stopped

Figure 11.7 shows the timing scheme to apply when the emergency stop button is turned ON with the inverter running. Input to the EN1 and EN2 goes OFF, bringing the inverter into the Safe Torque Off (STO) state and coasting the motor to a stop.

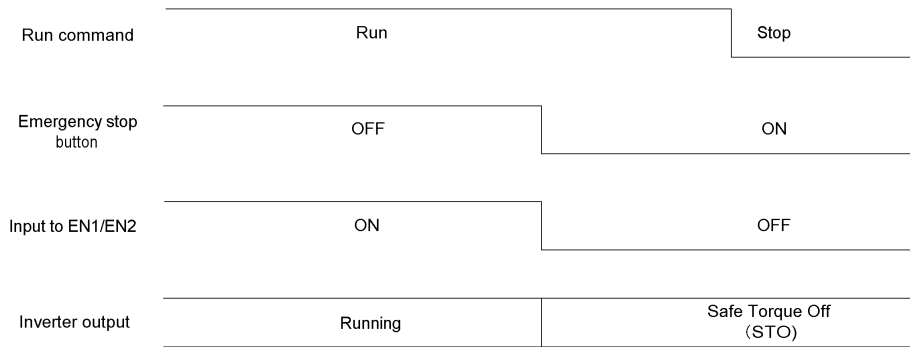

Figure 11.7 Inverter Output State when the Emergency Stop Button is Turned ON with the Inverter Running

11.1.4.5 *ECF* alarm (caused by logic discrepancy) and inverter output state

Turning the emergency stop button ON turns EN1 and EN2 inputs OFF and brings the inverter into the Safe Torque Off (STO) state. When a discrepancy of EN1 and EN2 inputs occurs during a time longer than 50 ms, the inverter interprets it as a logic discrepancy outputting an *ECF* alarm on the screen of the standard keypad; if it is shorter than 50 ms, no alarm occurs. The alarm can be reset by removing power of the inverter.

Figure 11.8 shows the timing scheme when the signals of EN1 and EN2 inputs are not simultaneous so that an alarm *ECF* occurs.

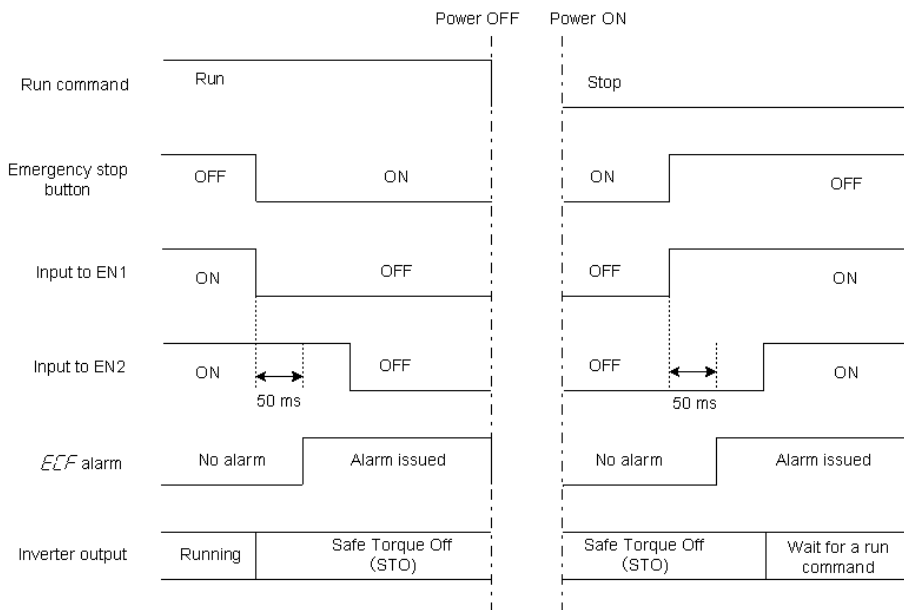

Figure 11.8 *ECF* Alarm (Caused by Logic Discrepancy) and Inverter Output State

11.1.4.6 Prevention of restarting

To prevent the inverter from restarting just by turning the emergency stop button OFF, configure the Enable input circuit as shown in Figure 11.9. Figure 11.10 shows the timing scheme for prevention of restarting.

HLD ("Enable 3-wire operation") must be assigned to any digital input terminal; for example, setting the E01 data to "6" sets up the **HLD** function at the [X1] terminal.

After the **FWD** comes ON with the **HLD** function being ON, even turning the **FWD** OFF keeps the inverter running due to the **HLD** function. Turning the emergency stop button ON under the condition causes the motor to coast to a stop. After that, turning the emergency stop button OFF no longer starts the inverter to run. To run the inverter, turn the **FWD** ON again.

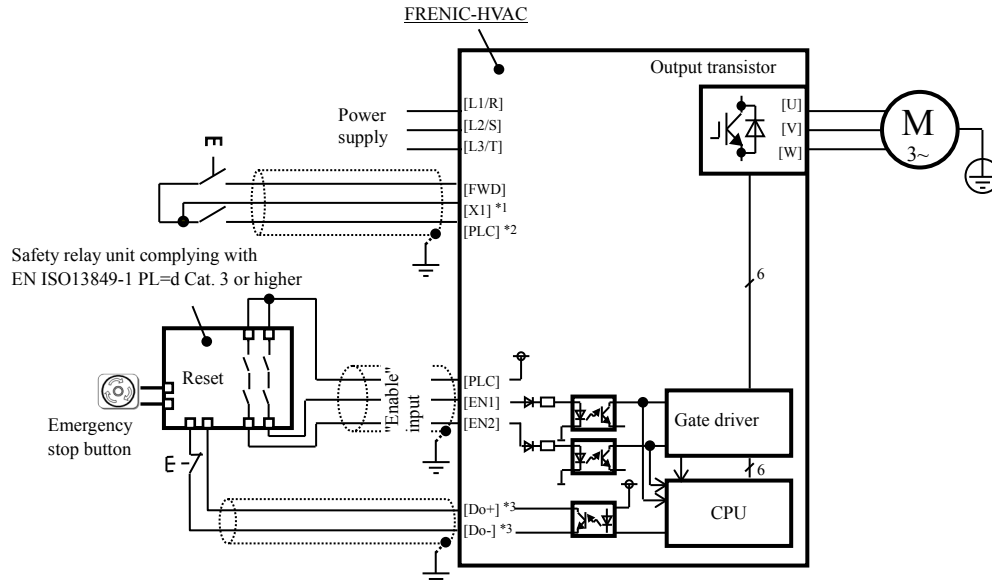

*1 Digital input terminal (e.g., [X1])

*2 If SW1 is in the SOURCE mode, [PLC] applies; if in the SINK mode, [CM] applies

*3 Transistor output terminals (e.g., [Y1]-[CMY], **DEC**F (Function code data=1101))

Figure 11.9 Connection Diagram and Internal Circuit Configuration

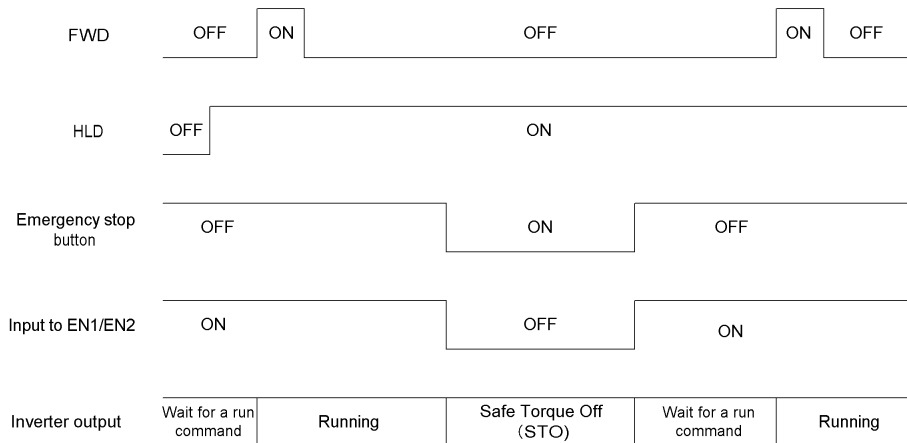

Figure 11.10 Prevention of Restarting

11.2 Conformity with UL Standards and cUL-listed for Canada

11.2.1 General

Originally, the UL standards were established by Underwriters Laboratories, Inc. as private criteria for inspections/investigations pertaining to fire/accident insurance in the USA. The UL marking on Fuji products is related to the UL Standard UL508C.

cUL certification means that UL has given certification for products to clear CSA Standards. cUL certified products are equivalent to those compliant with CSA Standards. The cUL marking on Fuji products is related to the CSA Standard C22.2 No. 14.

11.2.2 Conformity with UL standards and cUL-listed for Canada

UL/cUL-listed inverters are subject to the regulations set forth by the UL standards and CSA standards (cUL-listed for Canada) by installation within precautions listed below.

1. Solid state motor overload protection (motor protection by electronic thermal overload relay) is provided in each model.

Use function codes F10 to F12 to set the protection level.

2. Use 75°C (167°F) Cu wire only.
3. Use Class 1 wire only for control circuits.
4. Short circuit rating

"Suitable For Use On A Circuit Of Delivering Not More Than 100,000 rms Symmetrical Amperes, 240 Volts Maximum for 230V class input 25 HP or less, 230 Volts Maximum for 230V class input 30 HP or above when protected by Class J Fuses or a Circuit Breaker having an interrupting rating not less than 100,000 rms Symmetrical Amperes, 240 Volts Maximum. Models FRN; rated for 230V class input.

"Suitable For Use On A Circuit Of Delivering Not More Than 100,000 rms Symmetrical Amperes, 480 Volts Maximum when protected by Class J Fuses or a Circuit Breaker having an interrupting rating not less than 100,000 rms Symmetrical Amperes, 480 Volts Maximum. Models FRN; rated for 460V class input.

"Suitable For Use On A Circuit Of Delivering Not More Than 100,000 rms Symmetrical Amperes, 600 Volts Maximum when protected by Class J Fuses or a Circuit Breaker having an interrupting rating not less than 100,000 rms Symmetrical Amperes, 600 Volts Maximum. Models FRN; rated for 575V class input.

"Integral solid state short circuit protection does not provide branch circuit protection. Branch circuit protection must be provided in accordance with the National Electrical Code and any additional local codes."

5. Field wiring connections must be made by a UL Listed and CSA Certified closed-loop terminal connector sized for the wire gauge involved. Connector must be fixed using the crimp tool specified by the connector manufacturer.

6. All circuits with terminals L1/R, L2/S, L3/T, R0, T0, R1, T1 must have a common disconnect and be connected to the same pole of the disconnect if the terminals are connected to the power supply. Terminals R0, T0 must be protected by Class J Fuses or a Circuit Breakers for all capacity in the figure below.

Terminals R1, T1 must be protected by Class J Fuses or a Circuit Breakers in the figure below.
(200V class series 55kW (75HP) only)

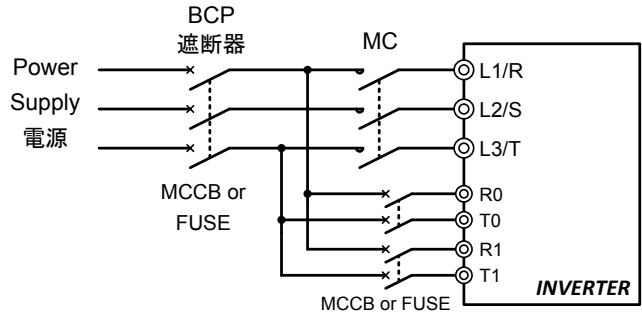

7. Environmental rating

- Maximum Surrounding Air Temperature / Maximum ambient temperature

The ambient temperature and surrounding temperature shall be lower than the values in the table below.

Type	Temperature
FRN_ _ _ AR1S-□□ / FRN_ _ _ AR1M-□□	50 deg C (122 deg F)
FRN_ _ _ AR1L-□□ / FRN_ _ _ AR1U-□□	40 deg C (104 deg F)

- Atmosphere

For use in pollution degree 2 environments. (for Open-Type models)

8. UL enclosure type

UL enclosed type formats are shown in the table below.

Enclosure Type	Standard Type
Open Type	FRN_ _ _ AR1S-□□
NEMA/UL Type 1	FRN_ _ _ AR1M-□□ FRN_ _ _ AR1U-□□
NEMA/UL Type 12	FRN_ _ _ AR1L-□□

9. Plenum rated drives

UL Enclosed Type is suitable for installation in a compartment handling conditioned air.

10. Mounting the wiring plate

To use inverters with cable gland plate as standard intended for Europe and so on as UL compliant products, attach a separate conduit plate.

Please contact Fuji representative for the conduit plates.

11. Functional description of control circuit terminals

A power source for connection to the Integrated alarm output (30A, 30B, 30C) should be limited to overvoltage category II such as control circuit or secondary winding of power transformer.

Classification	Terminal Symbol	Terminal Name	Functional description
Contact output	[30A/B/C]	Alarm relay output	When the inverter stops with an alarm, output is generated on the relay contact (1C). Contact capacitance: 250 VAC 0.3A cosφ = 1.0, 48 VDC 0.5 A

12. Install UL certified fuses or circuit breaker between the power supply and the inverter, referring to the table below.

Table 11.3 Fuses and Circuit Breakers

Power supply voltage	Nominal applied motor (HP)	Inverter type	Class J fuse size *1	Circuit breaker trip size *1	Required torque lb-in (N•m)			
					Main terminal	Control circuit	Aux. control power supply	Aux. fan power supply
Three-phase 230V	1	FRN001AR1■-2U	10	5	15.9 (1.8)	6.1 (0.7)	10.6 (1.2)	-
	2	FRN002AR1■-2U		10				
	3	FRN003AR1■-2U		15				
	5	FRN005AR1■-2U	25					
	7.5	FRN007AR1■-2U	35	30	51.3 (5.8)			
	10	FRN010AR1■-2U	50	40				
	15	FRN015AR1■-2U	70	50				
	20	FRN020AR1■-2U	100	75	119.4 (13.5)			
	25	FRN025AR1■-2U	125	100				
	30	FRN030AR1■-2U	-	100 (*2)				
	40	FRN040AR1■-2U		150 (*2)				
	50	FRN050AR1■-2U		175 (*2)				
	60	FRN060AR1■-2U		200 (*2)				
	75	FRN075AR1S-2U	350	250	238.9 (27)			
100	FRN100AR1S-2U	500	350	424.7 (48)				
125	FRN125AR1S-2U	600	400					

Note: A box (■) replaces an alphabetic letter depending on the enclosure. M (NEMA/UL TYPE 1) or L (NEMA/UL TYPE 12)

*1 Not more than 6 rms Amperes fuses or not more than 5 rms Amperes breakers for aux. control power supply and aux. main power supply.

*2 Protect the inverter by both circuit breaker and the fuse tabulated below connected in series.

Inverter type	Fuse type	
	Made by Mersen	Made by Bussmann
FRN030AR1■-2U	A70QS250-4	FWP-250A
FRN040AR1■-2U		
FRN050AR1■-2U	A70QS350-4	FWP-350A
FRN060AR1■-2U		

Table 11.3 Fuses and Circuit Breakers (continued)

Power supply voltage	Nominal applied motor (HP)	Inverter type	Class J fuse size *1	Circuit breaker trip size *1	Required torque lb-in (N•m)			
					Main terminal	Control circuit	Aux. control power supply	Aux. fan power supply
Three-phase 460V	1	FRN001AR1■-4U	3	5	15.9 (1.8)	6.1 (0.7)	10.6 (1.2)	-
	2	FRN002AR1■-4U	6					
	3	FRN003AR1■-4U	10	10				
	5	FRN005AR1■-4U	15					
	7.5	FRN007AR1■-4U	20	15				
	10	FRN010AR1■-4U	25	20				
	15	FRN015AR1■-4U	35	30	51.3 (5.8)			
	20	FRN020AR1■-4U	50	40				
	25	FRN025AR1■-4U	60	50				
	30	FRN030AR1■-4U	70					
	40	FRN040AR1■-4U	100	75	119.4 (13.5)			
	50	FRN050AR1■-4U	125	100				
	60	FRN060AR1■-4U	-	100 (*2)	238.9 (27)			
	75	FRN075AR1■-4U		150 (*2)				
	100	FRN100AR1■-4U		175 (*2)				
	125	FRN125AR1■-4U		200 (*2)				
	150	FRN150AR1S-4U	350	250	424.7 (48)			
	200	FRN200AR1S-4U	400	300				
	250	FRN250AR1S-4U	500	350				
	300	FRN300AR1S-4U	600	500				
350	FRN350AR1S-4U	-						
450	FRN450AR1S-4U		600					
500	FRN500AR1S-4U		800					
600	FRN600AR1S-4U		1200					
800	FRN800AR1S-4U		1400					
900	FRN900AR1S-4U		1600					
1000	FRN1000AR1S-4U							

Note: A box (■) replaces an alphabetic letter depending on the enclosure. M (NEMA/UL TYPE 1) or L (NEMA/UL TYPE 12)

*1 Not more than 6 rms Amperes fuses or not more than 5 rms Amperes breakers for aux. control power supply and aux. main power supply.

*2 Protect the inverter by both circuit breaker and the fuse tabulated below connected in series.

Inverter type	Fuse type	
	Made by Mersen	Made by Bussmann
FRN060AR1■-4U	A70QS250-4	FWP-250A
FRN075AR1■-4U		
FRN100AR1■-4U	A70QS350-4	FWP-350A
FRN125AR1■-4U		

Table 11.3 Fuses and Circuit Breakers (continued)

Power supply voltage	Nominal applied motor (HP)	Inverter type	Class J fuse size *1	Circuit breaker trip size *1	Required torque lb-in (N•m)				
					Main terminal	Control circuit	Aux. control power supply	Aux. fan power supply	
Three-phase 575V	1	FRN001AR1■-5U	3	5	15.9 (1.8)	6.1 (0.7)	10.6 (1.2)	-	
	2	FRN002AR1■-5U	6						
	3	FRN003AR1■-5U							
	5	FRN005AR1■-5U	10	10					
	7.5	FRN007AR1■-5U	15						
	10	FRN010AR1■-5U	20	15					
	15	FRN015AR1■-5U	25	20	51.3 (5.8)				
	20	FRN020AR1■-5U	35	30					
	25	FRN025AR1■-5U	40						
	30	FRN030AR1■-5U	50	40	238.9 (27)				
	40	FRN040AR1■-5U	70	50					
	50	FRN050AR1■-5U	100	60					
	60	FRN060AR1■-5U	-	75 (*2)					119.4 (13.5)
	75	FRN075AR1■-5U		100 (*2)					
	100	FRN100AR1■-5U		125 (*2)					238.9 (27)
	125	FRN125AR1■-5U		150 (*2)					
	150	FRN150AR1■-5U		175 (*2)					
	200	FRN200AR1S-5U	350	250	424.7 (48)				
250	FRN250AR1S-5U	450	300						
300	FRN300AR1S-5U	500	350						

Note: A box (■) replaces an alphabetic letter depending on the enclosure. M (NEMA/UL TYPE 1) or L (NEMA/UL TYPE 12)

*1 Not more than 6 rms Amperes fuses or not more than 5 rms Amperes breakers for aux. control power supply and aux. main power supply.

*2 Protect the inverter by both circuit breaker and the fuse tabulated below connected in series.

Inverter type	Fuse type	
	Made by Mersen	Made by Bussmann
FRN060AR1■-5U	A70QS175-4	FWP-175A
FRN075AR1■-5U		
FRN100AR1■-5U	A70QS250-4	FWP-250A
FRN125AR1■-5U		
FRN150AR1■-5U		

Table 11.4 Recommended Wire Sizes

Power supply voltage	Nominal applied motor (HP)	Inverter type	Wire size AWG (mm ²)						
			For main circuits Cu wires		For control circuits	Aux. control power supply *1	Aux. main circuit power supply *1		
			[L1/R, L2/S, L3/T] *1	[U, V, W] *1					
Three-phase 230V	1	FRN001AR1■-2U	14 (2.1) *2	14 (2.1) *2	18 (0.8) *2	14 (2.1) *2			
	2	FRN002AR1■-2U							
	3	FRN003AR1■-2U							
	5	FRN005AR1■-2U		12 (3.3) *2					
	7.5	FRN007AR1■-2U	10 (5.3) *2	10 (5.3) *2				-	
	10	FRN010AR1■-2U		8 (8.4)					
	15	FRN015AR1■-2U	8 (8.4)	6 (13.3)					
	20	FRN020AR1■-2U	6 (13.3)						
	25	FRN025AR1■-2U	4 (21.2)	2 (33.6)					
	30	FRN030AR1■-2U							
	40	FRN040AR1■-2U	2 (33.6)	14 (2.1) *2					
	50	FRN050AR1■-2U	1/0 (53.5)						
	60	FRN060AR1■-2U	2/0 (67.4)						
	75	FRN075AR1S-2U	4/0×2 (107.2) *3						4/0 (107.2) *3
	100	FRN100AR1S-2U	3/0×2 (85×2) *3						3/0×2 (85×2) *3
125	FRN125AR1S-2U	4/0×2 (107.2×2) *3	4/0×2 (107.2×2) *3						

Note: A box (■) replaces an alphabetic letter depending on the enclosure.
M (NEMA/UL TYPE 1) or L (NEMA/UL TYPE 12)

Note: The inverter's grounding wire size must be provided in accordance with the National Electrical Code.

*1 Use wires rated at the maximum allowable temperature of 75°C (167°F).

*2 No terminal end treatment is required for connection.

*3 The wire size of UL Open Type and NEMA/UL Type 1 are common. Please contact us if UL Open Type exclusive wire is necessary.

Table 11.4 Recommended Wire Sizes (continued)

Power supply voltage	Nominal applied motor (HP)	Inverter type	Wire size AWG (mm ²)				
			For main circuits Cu wires		For control circuits	Aux. control power supply *1	Aux. main circuit power supply *1
			[L1/R, L2/S, L3/T] *1	[U, V, W] *1			
Three-phase 460V	1	FRN001AR1■-4U	14 (2.1) ^{*2}	14 (2.1) ^{*2}	18 (0.8) ^{*2}	14 (2.1) ^{*2}	
	2	FRN002AR1■-4U					
	3	FRN003AR1■-4U					
	5	FRN005AR1■-4U					
	7.5	FRN007AR1■-4U					
	10	FRN010AR1■-4U	12 (3.3) ^{*2}				
	15	FRN015AR1■-4U	10 (5.3) ^{*2}	10 (5.3) ^{*2}			
	20	FRN020AR1■-4U					
	25	FRN025AR1■-4U	8 (8.4)	8 (8.4)			
	30	FRN030AR1■-4U	6 (13.3)	6 (13.3)			
	40	FRN040AR1■-4U	4 (21.2)	2 (33.6)			
	50	FRN050AR1■-4U					
	60	FRN060AR1■-4U	2 (33.6)				
	75	FRN075AR1■-4U	1/0 (53.5)	1/0 (53.5)			
	100	FRN100AR1■-4U	2/0 (67.4)	3/0 (85)			
	125	FRN125AR1■-4U	1/0×2 (53.5×2) ^{*3}	1/0×2 (53.5×2) ^{*3}			
	150	FRN150AR1S-4U		2/0×2 (67.4×2) ^{*3}			
	200	FRN200AR1S-4U	3/0×2 (85×2) ^{*3}	3/0×2 (85×2) ^{*3}			
	250	FRN250AR1S-4U	4/0×2 (107.2×2) ^{*3}	250×2 (127×2) ^{*3}			
	300	FRN300AR1S-4U	250×2 (127×2) ^{*3}	300×2 (152×2) ^{*3}			
	350	FRN350AR1S-4U	400×2 (203×2) ^{*3}	400×2 (203×2) ^{*3}			
	450	FRN450AR1S-4U	400×2 (203×2) ^{*4}	400×2 (203×2) ^{*4}			
	500	FRN500AR1S-4U	500×2 (253×2) ^{*4}	500×2 (253×2) ^{*4}			
600	FRN600AR1S-4U	350×3 (177×3) ^{*4}	400×3 (203×3) ^{*4}				
800	FRN800AR1S-4U	500×3 (253×3) ^{*4}	600×3 (304×3) ^{*4}				
900	FRN900AR1S-4U	600×3 (304×3) ^{*4}	500×4 (253×4) ^{*4}				
1000	FRN1000AR1S-4U						

Note: A box (■) replaces an alphabetic letter depending on the enclosure.
M (NEMA/UL TYPE 1) or L (NEMA/UL TYPE 12)

Note: The inverter's grounding wire size must be provided in accordance with the National Electrical Code.

*1 Use wires rated at the maximum allowable temperature of 75°C (167°F).

*2 No terminal end treatment is required for connection.

*3 The wire size of UL Open Type and NEMA/UL Type 1 are common. Please contact us if UL Open Type exclusive wire is necessary.

*4 It is showing the wire size for UL Open Type.

See additional material INR-SI47-1365 for NEMA/UL Type 1 (Pack with TYPE1 kit).

Table 11.4 Recommended Wire Sizes (continued)

Power supply voltage	Nominal applied motor (HP)	Inverter type	Wire size AWG (mm ²)				
			For main circuits Cu wires		For control circuits	Aux. control power supply *1	Aux. main circuit power supply *1
			[L1/R, L2/S, L3/T] *1	[U, V, W] *1			
Three-phase 575V	1	FRN001AR1■-5U	14 (2.1) *2	14 (2.1) *2	18 (0.8) *2	14 (2.1) *2	-
	2	FRN002AR1■-5U					
	3	FRN003AR1■-5U					
	5	FRN005AR1■-5U					
	7.5	FRN007AR1■-5U					
	10	FRN010AR1■-5U					
	15	FRN015AR1■-5U	12 (3.3) *2	10 (5.3) *2			
	20	FRN020AR1■-5U	12 (3.3) *2				
	25	FRN025AR1■-5U	10 (5.3) *2	8 (8.4)			
	30	FRN030AR1■-5U	8 (8.4)	6 (13.3)			
	40	FRN040AR1■-5U					
	50	FRN050AR1■-5U	4 (21.2)	4 (21.2)			
	60	FRN060AR1■-5U	1/0 (53.5)	1/0 (53.5)			
	75	FRN075AR1■-5U					
	100	FRN100AR1■-5U					
	125	FRN125AR1■-5U	1/0×2 (53.5×2) *3	1/0×2 (53.5×2) *3			
150	FRN150AR1■-5U						
200	FRN200AR1S-5U	2/0×2 (67.4×2) *3	2/0×2 (67.4×2) *3				
250	FRN250AR1S-5U		3/0×2 (85×2) *3				
300	FRN300AR1S-5U						

Note: A box (■) replaces an alphabetic letter depending on the enclosure. M (NEMA/UL TYPE 1) or L (NEMA/UL TYPE 12)

Note: The inverter's grounding wire size must be provided in accordance with the National Electrical Code.

*1 Use wires rated at the maximum allowable temperature of 75°C (167°F).

*2 No terminal end treatment is required for connection.

*3 The wire size of UL Open Type and NEMA/UL Type 1 are common. Please contact us if UL Open Type exclusive wire is necessary.

Appendices

Contents

App. A	Advantageous Use of Inverters (Notes on electrical noise)	1
A.1	Effect of inverters on other devices	1
A.2	Noise.....	3
A.3	Noise prevention.....	5
App. B	Effect on Insulation of General-purpose Motors Driven with 400 V Class Inverters	13
B.1	Generating mechanism of surge voltages	13
B.2	Effect of surge voltages	14
B.3	Countermeasures against surge voltages	14
B.4	Regarding existing equipment	15
App. C	Inverter Generating Loss.....	16
App. D	Connection Notes at Inverter Replacement Time (Using the high power factor PWM converter, RHC series).....	18

App. A Advantageous Use of Inverters (Notes on electrical noise)

- Disclaimer: This document provides you with a summary of the Technical Document of the Japan Electrical Manufacturers' Association (JEMA) (April 1994). It is intended to apply to the domestic market only. It is only for reference for the foreign market. -

A.1 Effect of inverters on other devices

Inverters have been and are rapidly expanding its application fields. This paper describes the effect that inverters have on electronic devices already installed or on devices installed in the same system as inverters, as well as introducing noise prevention measures. (Refer to Section A.3 [3], "Noise prevention examples" for details.)

[1] Effect on AM radios

Phenomenon If an inverter operates, AM radios may pick up noise radiated from the inverter. (An inverter has almost no effect on FM radios or television sets.)

Probable cause Radios may receive noise radiated from the inverter.

Measures Inserting a noise filter on the power supply side of the inverter is effective.

[2] Effect on telephones

Phenomenon If an inverter operates, nearby telephones may pick up noise radiated from the inverter in conversation so that it may be difficult to hear.

Probable cause A high-frequency leakage current radiated from the inverter and motors enters shielded telephone cables, causing noise.

Measures It is effective to commonly connect the grounding terminals of the motors and return the common grounding line to the grounding terminal of the inverter.

[3] Effect on proximity switches

Phenomenon If an inverter operates, proximity switches (capacitance-type) may malfunction.

Probable cause The capacitance-type proximity switches may provide inferior noise immunity.

Measures It is effective to connect a filter to the input terminals of the inverter or change the power supply treatment of the proximity switches. The proximity switches can be replaced with superior noise immunity types such as magnetic types.

[4] Effect on pressure sensors

Phenomenon If an inverter operates, pressure sensors may malfunction.

Probable cause Noise may penetrate through a grounding wire into the signal line.

Measures It is effective to install a noise filter on the power supply side of the inverter or to change the wiring.

[5] Effect on position detectors (pulse encoders)

Phenomenon If an inverter operates, pulse encoders may produce erroneous pulses that shift the stop position of a machine.

Probable cause Erroneous pulses are liable to occur when the signal lines of the PG and power lines are bundled together.

Measure

The influence of induction noise and radiation noise can be reduced by separating the PG signal lines and power lines. Providing noise filters at the input and output terminals is also an effective measure.

A.2 Noise

This section gives a summary of noises generated in inverters and their effects on devices subject to noise.

[1] Inverter noise

Figure A.1 shows an outline of the inverter configuration. The inverter converts AC to DC (rectification) in a converter unit, and converts DC to AC (inversion) with 3-phase variable voltage and variable frequency. The conversion (inversion) is performed by PWM implemented by switching six transistors (IGBT: Insulated Gate Bipolar Transistor, etc), and is used for variable speed motor control.

Switching noise is generated by high-speed on/off switching of the six transistors. Noise current (i) is emitted and at each high-speed on/off switching, the noise current flows through stray capacitance (C) of the inverter, cable and motor to the ground. The amount of the noise current is expressed as follows:

$$i = C \cdot dv/dt$$

It is related to the stray capacitance (C) and dv/dt (switching speed of the transistors). Further, this noise current is related to the carrier frequency since the noise current flows each time the transistors are switched on or off.

In addition to the main circuit of the inverter, the DC-to-DC switching power regulator (DC/DC converter), which is the power source for the control circuit of the inverter, may be a noise source in the same principles as stated above.

The frequency band of this noise is less than approximately 30 to 40 MHz. Therefore, the noise will affect devices such as AM radios using low frequency band, but will not virtually affect FM radios and television sets using higher frequency than this frequency band.

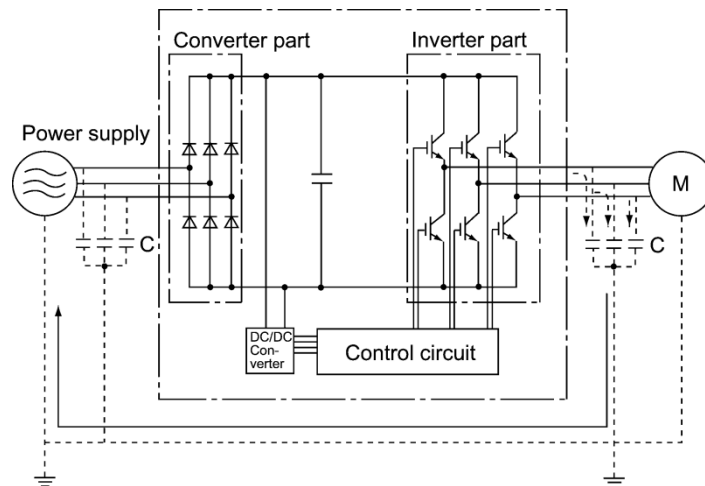

Figure A.1 Outline of Inverter Configuration

[2] Types of noise

Noise generated in an inverter is propagated through the main circuit wiring to the power supply and the motor so as to affect a wide range of applications from the power supply transformer to the motor. The various propagation routes are shown in Figure A.2. According to those routes, noises are roughly classified into three types--conduction noise, induction noise, and radiation noise.

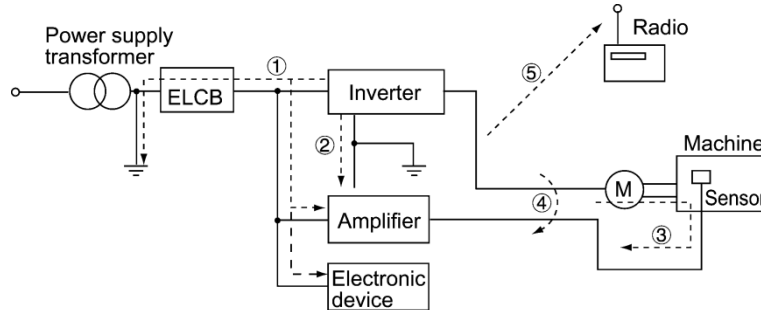

Figure A.2 Noise Propagation Routes

(1) Conduction noise

Noise generated in an inverter may propagate through the conductor and power supply so as to affect peripheral devices of the inverter (Figure A.3). This noise is called "conduction noise." Some conduction noises will propagate through the main circuit ①. If the ground wires are connected to a common ground, conduction noise will propagate through route ②. As shown in route ③, some conduction noises will propagate through signal lines or shielded wires.

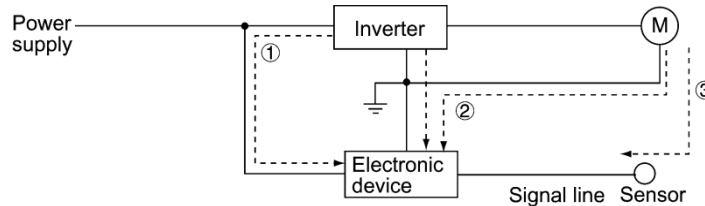

Figure A.3 Conduction Noise

(2) Induction noise

When wires or signal lines of peripheral devices are brought close to the wires on the input and output sides of the inverter through which noise current is flowing, noise will be induced into those wires and signal lines of the devices by electromagnetic induction (Figure A.4) or electrostatic induction (Figure A.5). This is called "induction noise" ④.

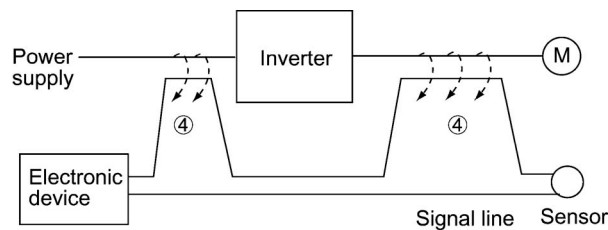

Figure A.4 Electromagnetic Induced Noise

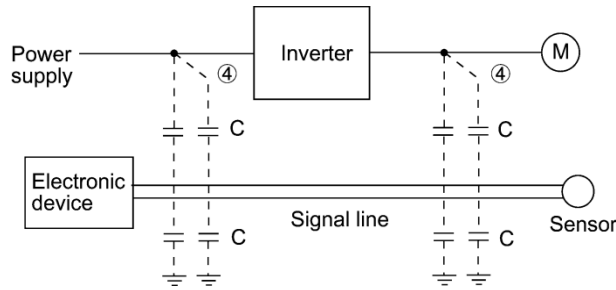

Figure A.5 Electrostatic Induced Noise

(3) Radiation noise

Noise generated in an inverter may be radiated through the air from wires (that act as antennas) at the input and output sides of the inverter so as to affect peripheral devices. This noise is called "radiation noise" ⑤ as shown below. Not only wires but motor frames or control system panels containing inverters may also act as antennas.

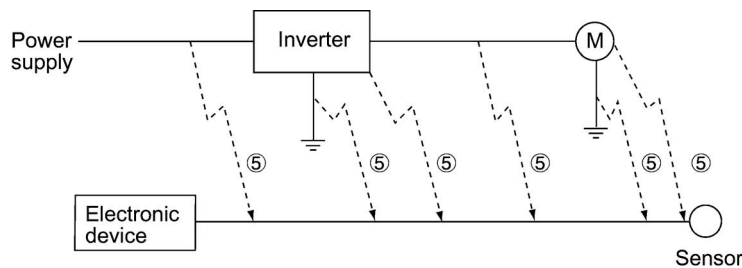

Figure A.6 Radiation Noise

A.3 Noise prevention

The more noise prevention is strengthened, the more effective. However, with the use of appropriate measures, noise problems may be resolved easily. It is necessary to implement economical noise prevention according to the noise level and the equipment conditions.

[1] Noise prevention prior to installation

Before installing an inverter in your control panel or installing an inverter panel, you need to consider noise prevention. Once noise problems occur, it will cost additional materials and time for solving them.

Noise prevention prior to installation includes:

- 1) Separating the wiring of main circuits and control circuits
- 2) Putting main circuit wiring into a metal conduit pipe
- 3) Using shielded wires or twisted shielded wires for control circuits.
- 4) Implementing appropriate grounding work and grounding wiring.

These noise prevention measures can avoid most noise problems.

[2] Implementation of noise prevention measures

There are two types of noise prevention measures--one for noise propagation routes and the other for noise receiving sides (that are affected by noise).

The basic measures for lessening the effect of noise at the receiving side include:

Separating the main circuit wiring from the control circuit wiring, avoiding noise effect.

The basic measures for lessening the effect of noise at the generating side include:

- 1) Inserting a noise filter that reduces the noise level.
- 2) Applying a metal conduit pipe or metal control panel that will confine noise, and
- 3) Applying an insulated transformer for the power supply that cuts off the noise propagation route.

Table A.1 lists the noise prevention measures, their goals, and propagation routes.

Table A.1 Noise Prevention Measures

Noise prevention method		Goal of noise prevention measures				Conduction route		
		Make it more difficult to receive noise	Cutoff noise conduction	Confine noise	Reduce noise level	Conduction noise	Induction noise	Radiation noise
Wiring and installation	Separate main circuit from control circuit	Y					Y	
	Minimize wiring distance	Y			Y		Y	Y
	Avoid parallel and bundled wiring	Y					Y	
	Use appropriate grounding	Y			Y	Y	Y	
	Use shielded wire and twisted shielded wire	Y					Y	Y
	Use shielded cable in main circuit			Y			Y	Y
	Use metal conduit pipe			Y			Y	Y
Control panel	Appropriate arrangement of devices in panel	Y					Y	Y
	Metal control panel			Y			Y	Y
Anti-noise device	Line filter	Y			Y	Y		Y
	Insulation transformer		Y			Y		Y
Measures at noise receiving sides	Use a passive capacitor for control circuit	Y					Y	Y
	Use ferrite core for control circuit	Y			Y		Y	Y
	Line filter	Y		Y		Y		
Others	Separate power supply systems		Y			Y		
	Lower the carrier frequency				Y*	Y	Y	Y

Y: Effective, Y*: Effective conditionally, Blank: Not effective

What follows is noise prevention measures for the inverter drive configuration.

(1) Wiring and grounding

As shown in Figure A.7, separate the main circuit wiring from control circuit wiring as far as possible regardless of being located inside or outside the system control panel containing an inverter. Use shielded wires and twisted shielded wires that will block out extraneous noises, and minimize the wiring distance. Also avoid bundled wiring of the main circuit and control circuit or parallel wiring.

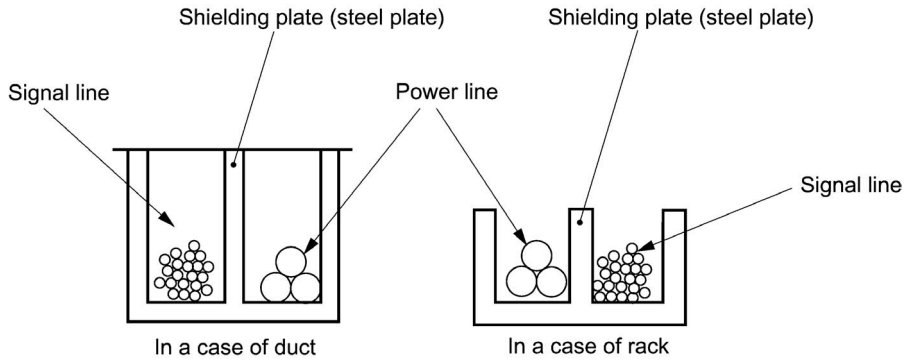

Figure A.7 Separate Wiring

For the main circuit wiring, use a metal conduit pipe and connect its wires to the ground to prevent noise propagation (refer to Figure A.8).

The shield (braided wire) of a shielded wire should be securely connected to the base (common) side of the signal line at only one point to avoid the loop formation resulting from a multi-point connection (refer to Figure A.9).

The grounding is effective not only to reduce the risk of electrical shocks due to leakage current, but also to block noise penetration and radiation. Corresponding to the main circuit voltage, the grounding work should be Class D (300 VAC or less, grounding resistance: 100Ω or less) and Class C (300 to 600 VAC, grounding resistance: 10Ω or less). Each ground wire is to be provided with its own ground or separately wired to a grounding point.

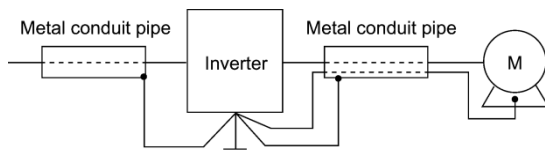

Figure A.8 Grounding of Metal Conduit Pipe

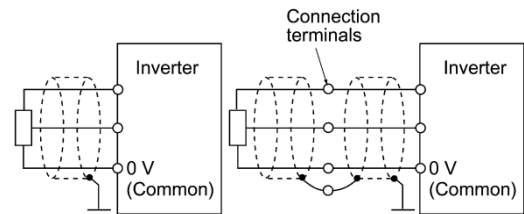

Figure A.9 Treatment of Braided Wire of Shielded Wire

(2) Control panel

The system control panel containing an inverter is generally made of metal, which can shield noise radiated from the inverter itself.

When installing other electronic devices such as a programmable logic controller in the same control panel, be careful with the layout of each device. If necessary, arrange shield plates between the inverter and peripheral devices.

(3) Anti-noise devices

To reduce the noise propagated through the electrical circuits and the noise radiated from the main circuit wiring to the air, a line filter and power supply transformer should be used (refer to Figure A.10).

Line filters are available in these types--the simplified type such as a capacitive filter to be connected in parallel to the power supply line and an inductive filter to be connected in series to the power supply line and the orthodox type such as an LC filter to meet radio noise regulations. Use them according to the targeted effect for reducing noise.

Power supply transformers include common insulated transformers, shielded transformers, and noise-cutting transformers. These transformers have different effectiveness in blocking noise propagation.

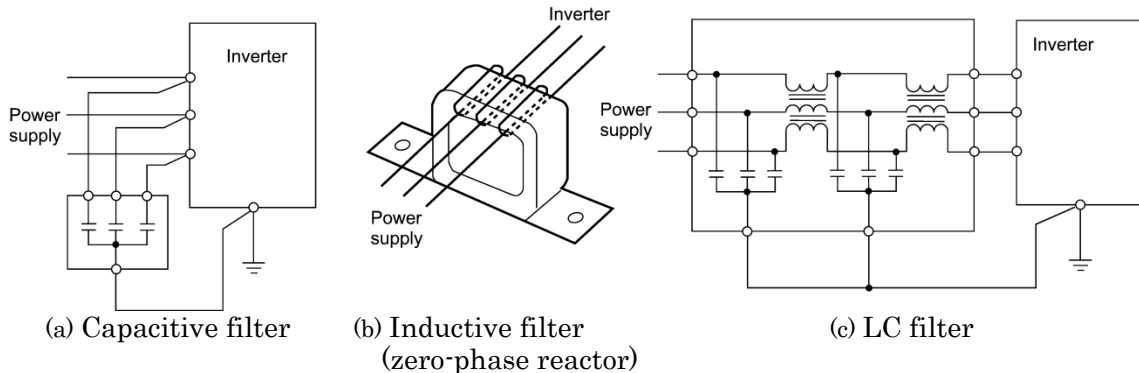

Figure A.10 Various Filters and their Connection

(4) Noise prevention measures at the receiving side

It is important to strengthen the noise immunity of those electronic devices installed in the same control panel as the inverter or located near an inverter. Line filters and shielded or twisted shielded wires are used to block the penetration of noise in the signal lines of these devices. The following treatments are also implemented.

- 1) Lower the circuit impedance by connecting capacitors or resistors to the input and output terminals of the signal circuit in parallel.
- 2) Increase the circuit impedance for noise by inserting choke coils in series in the signal circuit or passing signal lines through ferrite core beads. It is also effective to widen the signal base lines (0 V line) or grounding lines.

(5) Other

The level of generating/propagating noise will change with the carrier frequency of the inverter. The higher the carrier frequency, the higher the noise level.

In an inverter whose carrier frequency can be changed, lowering the carrier frequency can reduce the generation of electrical noise and result in a good balance with the audible noise of the motor under driving conditions.

[3] Noise prevention examples

Table A.2 lists examples of the measures to prevent noise generated by a running inverter.

Table A.2 Examples of Noise Prevention Measures

No.	Target device	Phenomena	Noise prevention measures	
				Notes
1	AM radio	<p>When operating an inverter, noise enters into an AM radio broadcast (500 to 1500 kHz).</p>  <p><Possible cause> The AM radio may receive noise radiated from wires at the power supply and output sides of the inverter.</p>	<p>1) Install an LC filter at the power supply side of the inverter. (In some cases, a capacitive filter may be used as a simple method.)</p> <p>2) Install a metal conduit wiring between the motor and inverter.</p>  <p>Note: Minimize the distance between the LC filter and inverter as short as possible (within 1 m).</p>	<p>1) The radiation noise of the wiring can be reduced.</p> <p>2) The conduction noise to the power supply side can be reduced.</p> <p>Note: Sufficient improvement may not be expected in narrow regions such as between mountains.</p>
2	AM radio	<p>When operating an inverter, noise enters into an AM radio broadcast (500 to 1500 kHz).</p>  <p><Possible cause> The AM radio may receive noise radiated from the power line at the power supply side of the inverter.</p>	<p>1) Install inductive filters at the input and output sides of the inverter.</p>  <p>The number of turns of the zero-phase reactor (or ferrite ring) should be as large as possible. In addition, wiring between the inverter and the zero-phase reactor (or ferrite ring) should be as short as possible. (within 1 m)</p> <p>2) When further improvement is necessary, install LC filters.</p> 	<p>1) The radiation noise of the wiring can be reduced.</p>

Table A.2 Continued

No.	Target device	Phenomena	Noise prevention measures	Notes
3	Telephone (in a common private residence at a distance of 40 m)	<p>When driving a ventilation fan with an inverter, noise enters a telephone in a private residence at a distance of 40m.</p>  <p><Possible cause> A high-frequency leakage current from the inverter and motor flowed to grounded part of the telephone cable shield. During the current's return trip, it flowed through a grounded pole transformer, and noise entered the telephone by electrostatic induction.</p>	<p>1) Connect the ground terminals of the motors in a common connection. Return to the inverter panel, and insert a 1 μF capacitor between the input terminal of the inverter and ground.</p>  	<p>1) The effect of the inductive filter and LC filter may not be expected because of sound frequency component.</p> <p>2) In the case of a V-connection power supply transformer in a 200V system, it is necessary to connect capacitors as shown in the following figure, because of different potentials to ground.</p>
4	Photoelectric relay	<p>A photoelectric relay malfunctioned when the inverter runs the motor.</p> <p>[The inverter and motor are installed in the same place (for overhead traveling)]</p>  <p><Possible cause> It is considered that induction noise entered the photoelectric relay since the inverter's input power supply line and the photoelectric relay's wiring are in parallel separated by approximately 25 mm over a distance of 30 to 40 m. Due to conditions of the installation, these lines cannot be separated.</p>	<p>1) As a temporary measure, Insert a 0.1 μF capacitor between the 0 V terminal of the power supply circuit in the detection unit of the overhead photoelectric relay and a frame of the overhead panel.</p>  <p>2) As a permanent measure, move the 24 V power supply from the ground to the overhead unit so that signals are sent to the ground side with relay contacts in the ceiling part.</p>	<p>1) The wiring is separated by more than 30 cm.</p> <p>2) When separation is impossible, signals can be received and sent with dry contacts etc.</p> <p>3) Do not wire low-current signal lines and power lines in parallel.</p>

Table A.2 Continued

No.	Target device	Phenomena	Noise prevention measures	Notes
5	Photoelectric relay	<p>A photoelectric relay malfunctioned when the inverter was operated.</p>  <p><Possible cause> Although the inverter and photoelectric relay are separated by a sufficient distance but the power supplies share a common connection, it is considered that conduction noise entered through the power supply line into the photoelectric relay.</p>	<p>1) Insert a 0.1 μF capacitor between the output common terminal of the amplifier of the photoelectric relay and the frame.</p> 	<p>1) If a low-current circuit at the malfunctioning side is observed, the measures may be simple and economical.</p>
6	Proximity switch (capacitance type)	<p>A proximity switch malfunctioned.</p>  <p><Possible cause> It is considered that the capacitance type proximity switch is susceptible to conduction and radiation noise because of its low noise immunity.</p>	<p>1) Install an LC filter at the output side of the inverter. 2) Install a capacitive filter at the input side of the inverter. 3) Ground the 0 V (common) line of the DC power supply of the proximity switch through a capacitor to the box body of the machine.</p> 	<p>1) Noise generated in the inverter can be reduced. 2) The switch is superseded by a proximity switch of superior noise immunity (such as a magnetic type).</p>

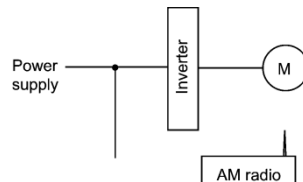
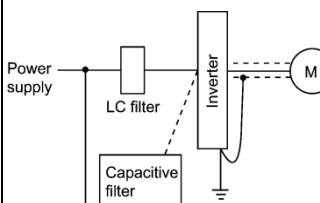
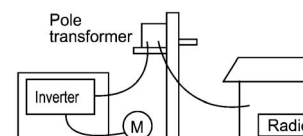
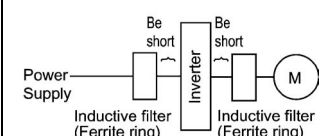
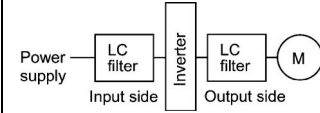
Table A.2 Continued

No.	Target device	Phenomena	Noise prevention measures	Notes
7	Pressure sensor	<p>A pressure sensor malfunctioned.</p>  <p><Possible cause> The pressure sensor may malfunction due to noise that came from the box body through the shielded wire.</p>	<ol style="list-style-type: none"> 1) Install an LC filter on the input side of the inverter. 2) Connect the shield of the shielded wire of the pressure sensor to the 0 V line (common) of the pressure sensor, changing the original connection. 	<ol style="list-style-type: none"> 1) The shielded parts of shield wires for sensor signals are connected to a common point in the system. 2) Conduction noise from the inverter can be reduced.
8	Position detector (pulse encoder)	<p>Erroneous-pulse outputs from a pulse converter caused a shift in the stop position of a crane.</p>  <p><Possible cause> Erroneous pulses may be outputted by induction noise since the power line of the motor and the signal line of the PG are bundled together.</p>	<ol style="list-style-type: none"> 1) Install an LC filter and a capacitive filter at the input side of the inverter. 2) Install an LC filter at the output side of the inverter. 	<ol style="list-style-type: none"> 1) This is an example of a measure where the power line and signal line cannot be separated. 2) Induction noise and radiation noise at the output side of the inverter can be reduced.
9	Program mable logic controller (PLC)	<p>The PLC program sometimes malfunctions.</p>  <p><Possible cause> Since the power supply system is the same for the PLC and inverter, it is considered that noise enters the PLC through the power supply.</p>	<ol style="list-style-type: none"> 1) Install a capacitive filter and an LC filter on the input side of the inverter. 2) Install an LC filter on the output side of the inverter. 3) Lower the carrier frequency of the inverter. 	<ol style="list-style-type: none"> 1) Total conduction noise and induction noise in the electric line can be reduced.

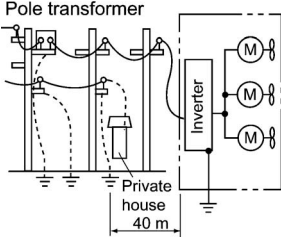
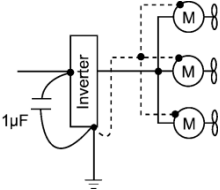
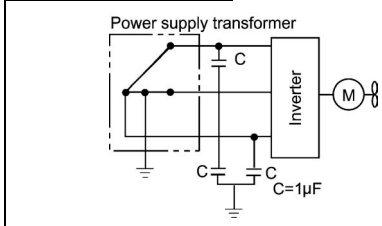
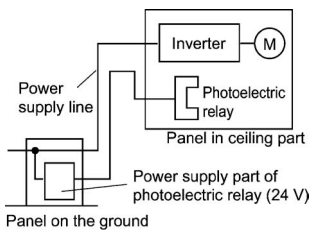
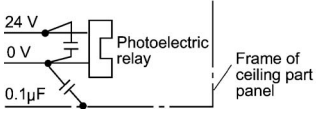
App. B Effect on Insulation of General-purpose Motors Driven with 400 V Class Inverters

- Disclaimer: This document provides you with a summary of the Technical Document of the Japan Electrical Manufacturers' Association (JEMA) (March, 1995). It is intended to apply to the domestic market only. It is only for reference for the foreign market. -

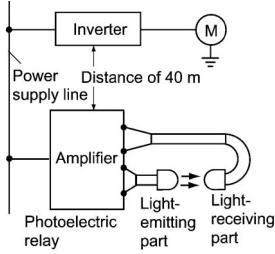
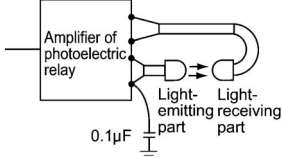
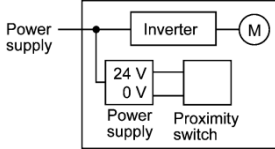
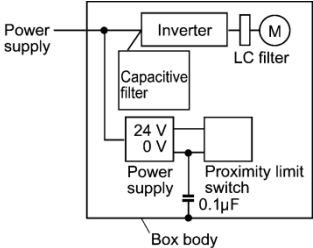
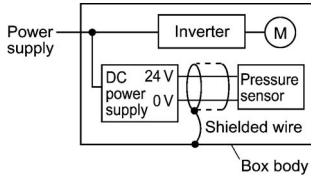
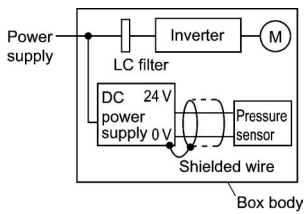
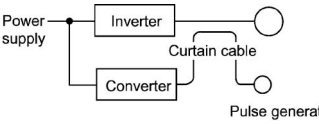
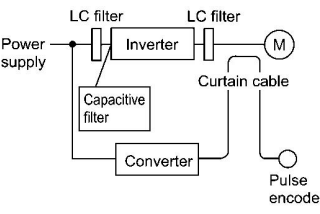
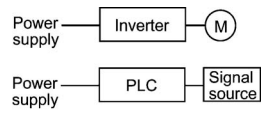
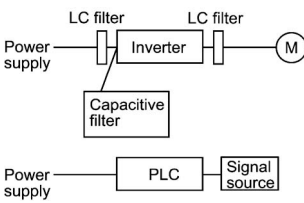
Preface

When an inverter drives a motor, surge voltages generated by switching the inverter elements are superimposed on the inverter output voltage and applied to the motor terminals. If the surge voltages are too high they may have an effect on the motor insulation and some cases have resulted in damage.

For preventing such cases this document describes the generating mechanism of the surge voltages and countermeasures against them.

 Refer to A.2 [1] "Inverter noise" for details of the principle of inverter operation.

B.1 Generating mechanism of surge voltages

As the inverter rectifies a commercial power source voltage and smoothes into a DC voltage, the magnitude E of the DC voltage becomes about $\sqrt{2}$ times that of the source voltage (about 620 V in case of an input voltage of 440 VAC). The peak value of the output voltage is usually close to this DC voltage value.

But, as there exists inductance (L) and stray capacitance (C) in wiring between the inverter and the motor, the voltage variation due to switching the inverter elements causes a surge voltage originating in LC resonance and results in the addition of high voltage to the motor terminals. (Refer to Figure B.1)

This voltage sometimes reaches up to about twice that of the inverter DC voltage ($620 \text{ V} \times 2 =$ approximately 1,200 V) depending on a switching speed of the inverter elements and wiring conditions.

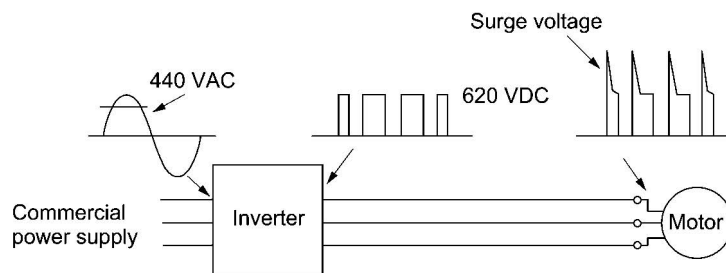
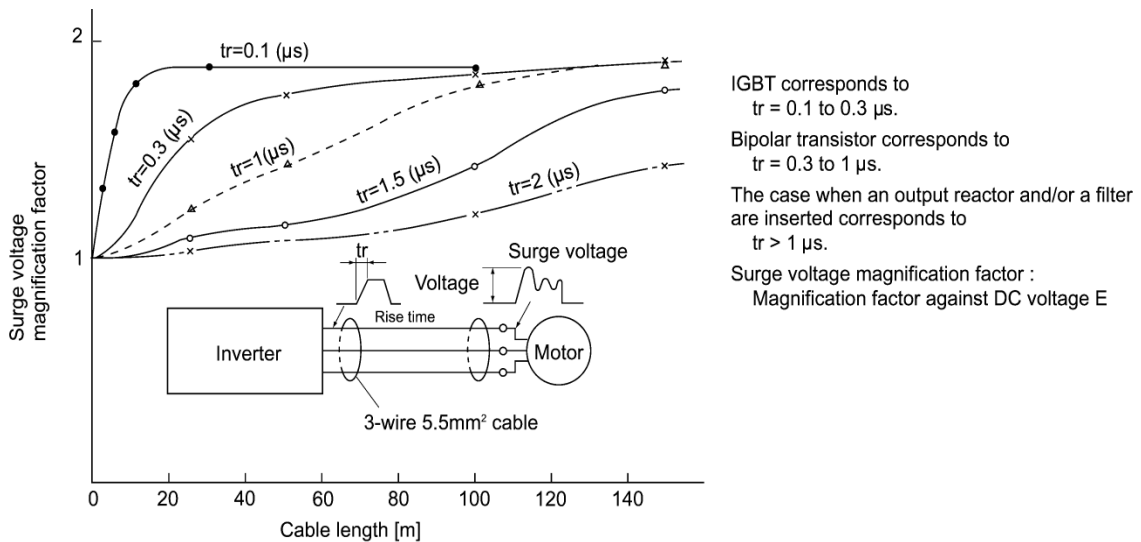

Figure B.1 Voltage Waveform of Individual Portions

A measured example in Figure B.2 illustrates the relation of a peak value of the motor terminal voltage with a wiring length between the inverter and the motor.

From this it can be confirmed that the peak value of the motor terminal voltage ascends as the wiring length increases and becomes saturated at about twice the inverter DC voltage.

The shorter a pulse rise time becomes, the higher the motor terminal voltage rises even in the case of a short wiring length.



Excerpt from [J. IEE Japan, Vol. 107, No. 7, 1987]

Figure B.2 Measured Example of Wiring Length and Peak Value of Motor Terminal Voltage

B.2 Effect of surge voltages

The surge voltages originating in LC resonance of wiring may be applied to the motor terminals and depending on their magnitude sometimes cause damage to the motor insulation.

When the motor is driven with a 200 V class inverter, the dielectric strength of the insulation is no problem since the peak value at the motor terminal voltage increases twice due to the surge voltages (the DC voltage is only about 300 V).

But in case of a 400 V class inverter, the DC voltage is approximately 600 V and depending on the wiring length, the surge voltages may greatly increase and sometimes result in damage to the insulation.

B.3 Countermeasures against surge voltages

When driving a motor with a 400 V class inverter, the following are countermeasures against damage to the motor insulation by the surge voltages.

[1] Using a surge suppressor unit, SSU

The surge suppressor unit (SSU) is a newly structured unit using circuits based on the impedance-matching theory of a transmission line. Just connecting the SSU to the surge suppressor cable of the existing equipment can greatly reduce the surge voltage that results in a motor dielectric breakdown.



For 50 m of wiring length: SSU 50TA-NS



For 100 m of wiring length: SSU 100TA-NS

[2] Suppressing surge voltages

There are two ways for suppressing the surge voltages, one is to reduce the voltage rise time and another is to reduce the voltage peak value.

(1) Output reactor

If wiring length is relatively short, the surge voltages can be suppressed by reducing the voltage rise time (dv/dt) with the installation of an AC reactor on the output side of the inverter. (Refer to Figure B.3 (1).)

However, if the wiring length becomes long, suppressing the peak voltage due to surge voltage may be difficult.

(2) Output filter

Installing a filter on the output side of the inverter allows a peak value of the motor terminal voltage to be reduced. (Refer to Figure B.3 (2).)

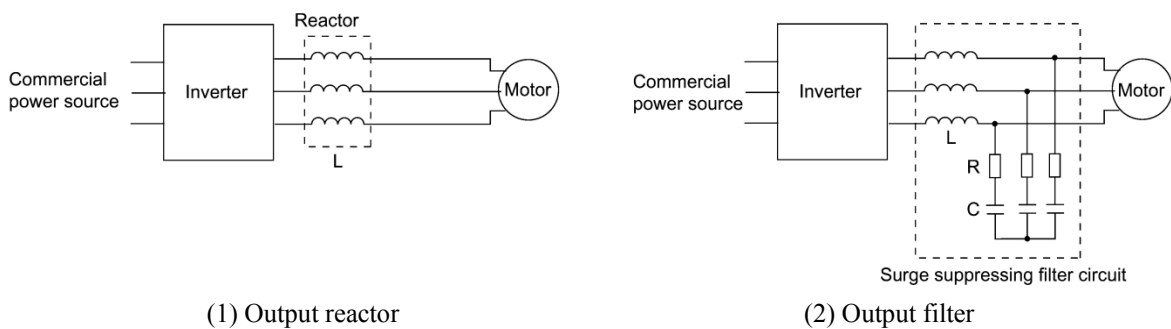

Figure B.3 Method to Suppress Surge Voltage

Tip If the wiring length between the inverter and the motor is comparatively long, the crest value of the surge voltage can be suppressed by connecting a surge suppressor unit (SSU) to the motor terminal. For details, refer to Chapter 4, Section 4.4.1.3 "Surge suppression unit (SSU)."

[3] Using motors with enhanced insulation

Enhanced insulation of a motor winding allows its surge withstanding to be improved.

B.4 Regarding existing equipment

[1] In case of a motor being driven with 400 V class inverter

A survey over the last five years on motor insulation damage due to the surge voltages originating from switching of inverter elements shows that the damage incidence is 0.013% under the surge voltage condition of over 1,100 V and most of the damage occurs several months after commissioning the inverter. Therefore there seems to be little probability of occurrence of motor insulation damage after a lapse of several months of commissioning.

[2] In case of an existing motor driven using a newly installed 400 V class inverter

We recommend suppressing the surge voltages with the ways shown in Section B.3.

App. C Inverter Generating Loss

The table below lists the inverter generating loss to apply when the carrier frequency and output current are selected within the power derating curve. (Refer to Chapter 2, Table 2.6.)

Power supply voltage	Inverter type	Generating loss (W)
Three-phase 230 V	FRN001AR1■-2U	60
	FRN002AR1■-2U	90
	FRN003AR1■-2U	125
	FRN005AR1■-2U	230
	FRN007AR1■-2U	280
	FRN010AR1■-2U	350
	FRN015AR1■-2U	480
	FRN020AR1■-2U	650
	FRN025AR1■-2U	700
	FRN030AR1■-2U	950
	FRN040AR1■-2U	1,350
	FRN050AR1■-2U	1,750
	FRN060AR1■-2U	1,900
	FRN075AR1S-2U	1,900
	FRN100AR1S-2U	2,300
FRN125AR1S-2U	2,750	
Three-phase 460 V	FRN001AR1■-4U	50
	FRN002AR1■-4U	65
	FRN003AR1■-4U	85
	FRN005AR1■-4U	135
	FRN007AR1■-4U	185
	FRN010AR1■-4U	260
	FRN015AR1■-4U	345
	FRN020AR1■-4U	440
	FRN025AR1■-4U	455
	FRN030AR1■-4U	600
	FRN040AR1■-4U	800
	FRN050AR1■-4U	910
	FRN060AR1■-4U	1000
	FRN075AR1■-4U	1050
	FRN100AR1■-4U	1300
	FRN125AR1■-4U	1850
	FRN150AR1S-4U	2250
	FRN200AR1S-4U	2700
	FRN250AR1S-4U	3000
	FRN300AR1S-4U	3750
	FRN350AR1S-4U	4200
	FRN450AR1S-4U	5400
FRN500AR1S-4U	6500	
FRN600AR1S-4U	7500	
FRN800AR1S-4U	9200	
FRN900AR1S-4U	11550	
FRN1000AR1S-4U	13500	

Note: A box (■) replaces an alphabetic letter depending on the enclosure.
M (NEMA/UL TYPE 1) or L (NEMA/UL TYPE 12)

(continue)

Power supply voltage	Inverter type	Generating loss (W)
Three-phase 575 V	FRN001AR1■-5U	40
	FRN002AR1■-5U	50
	FRN003AR1■-5U	60
	FRN005AR1■-5U	90
	FRN007AR1■-5U	120
	FRN010AR1■-5U	160
	FRN015AR1■-5U	210
	FRN020AR1■-5U	270
	FRN025AR1■-5U	320
	FRN030AR1■-5U	370
	FRN040AR1■-5U	520
	FRN050AR1■-5U	620
	FRN060AR1■-5U	960
	FRN075AR1■-5U	1180
	FRN100AR1■-5U	1570
	FRN125AR1■-5U	1870
	FRN150AR1■-5U	2200
	FRN200AR1S-5U	3500
	FRN250AR1S-5U	4300
	FRN300AR1S-5U	4900

Note: A box (■) replaces an alphabetic letter depending on the enclosure.
M (NEMA/UL TYPE 1) or L (NEMA/UL TYPE 12)

App. D Connection Notes at Inverter Replacement Time (Using the high power factor PWM converter, RHC series)

When making a replacement of the inverters listed below using the PWM converter RHC series, be sure to change the connections of the inverter's auxiliary control power input terminals (R0, T0). Otherwise, the replaced inverter may not function normally.

[1] Replacement inverters

Conventional inverters (before replacement)	Replacement inverters (after replacement)
FRENIC-G11S series • FRN30G11S-2, FRN30P11S-2 or higher type • FRN30G11S-4, FRN30P11S-4 or higher type FRENIC-VG7S series • FRN18.5VG7S-2, FRN18.5VG7S-4 or higher type	FRENIC-HVAC/AQUA series FRENIC-Ace series FRENIC-MEGA series FRENIC-VG series FRENIC-Eco series FRENIC-Lift series

WARNING

When using 230 V class series inverters of 60 HP or below and 460 V ones of 125 HP or below in combination with the PWM converter, be sure to remove EMC filter grounding screws (E1, E2). The 230 V class series inverters of 75HP or above and 460 V ones of 150 HP or above, remove the connector of the EMC filter.

Fire or an accident could occur.

When replacing conventional models (FRENIC5000VG7S, FRENIC5000G11S) with the FRENIC-HVAC, it may be necessary to change wiring.

Malfunction could occur.

[2] Changing connections of auxiliary control power input terminals (R0, T0)

(1) When using RHC series ■RHC7.5-2C to RHC90-2C or ■RHC7.5-4C to RHC220-4C

Connection diagram of conventional inverters (before replacement)

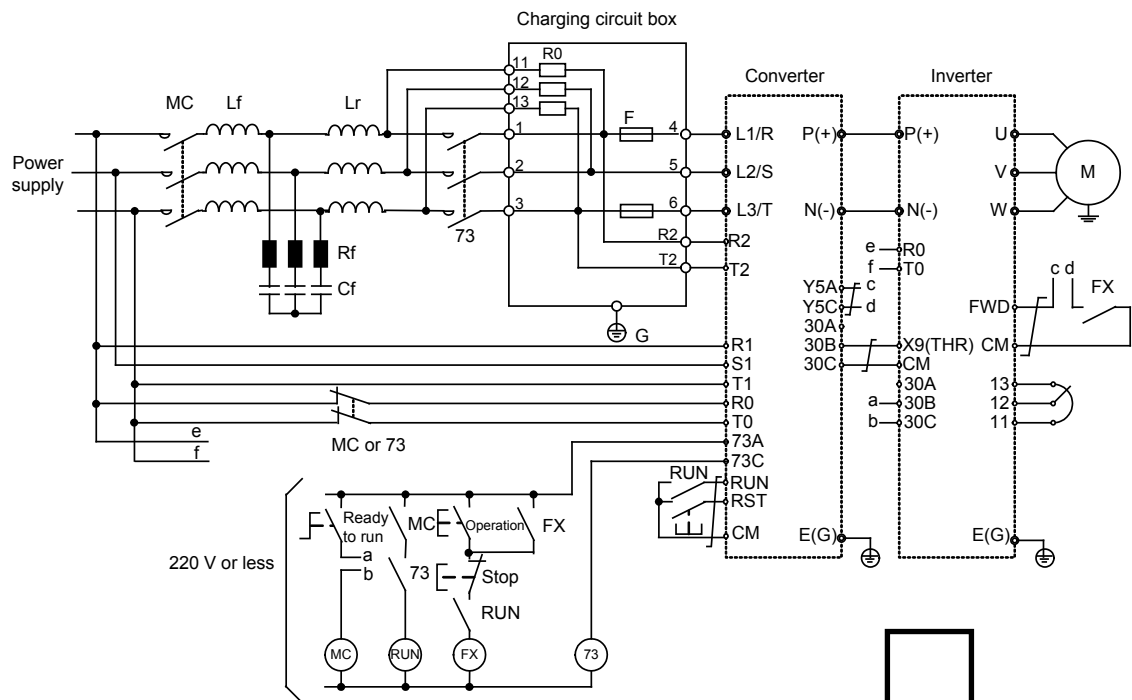

Connection diagram of replacement inverters (after replacement)

Change the connection marked with .

1) Auxiliary control power input terminals (R0, T0)

Be sure to connect these terminals to the main power supply *via normally-closed contacts* of the magnetic contactor (73 or MC) for the power supply circuit.

2) Auxiliary main circuit power input terminals (R1, T1), exclusive to inverters equipped with R1 and T1

Be sure to connect these terminals to the main power supply *without passing through normally-closed contacts* of the magnetic contactor (73 or MC) for the power supply circuit.

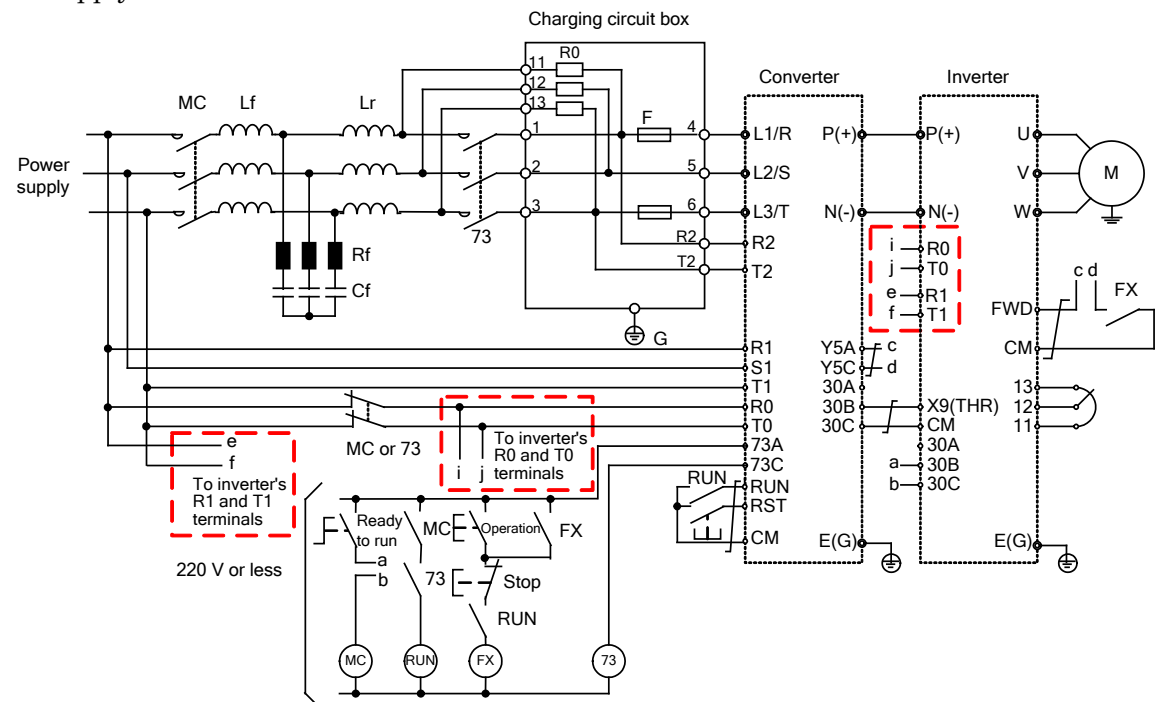

(2) When using RHC series ■RHC280-4C to RHC630-4C, ■RHC400-4C (VT mode), or ■RHC500B to RHC800B-4C

Connection diagram of conventional inverters (before replacement)

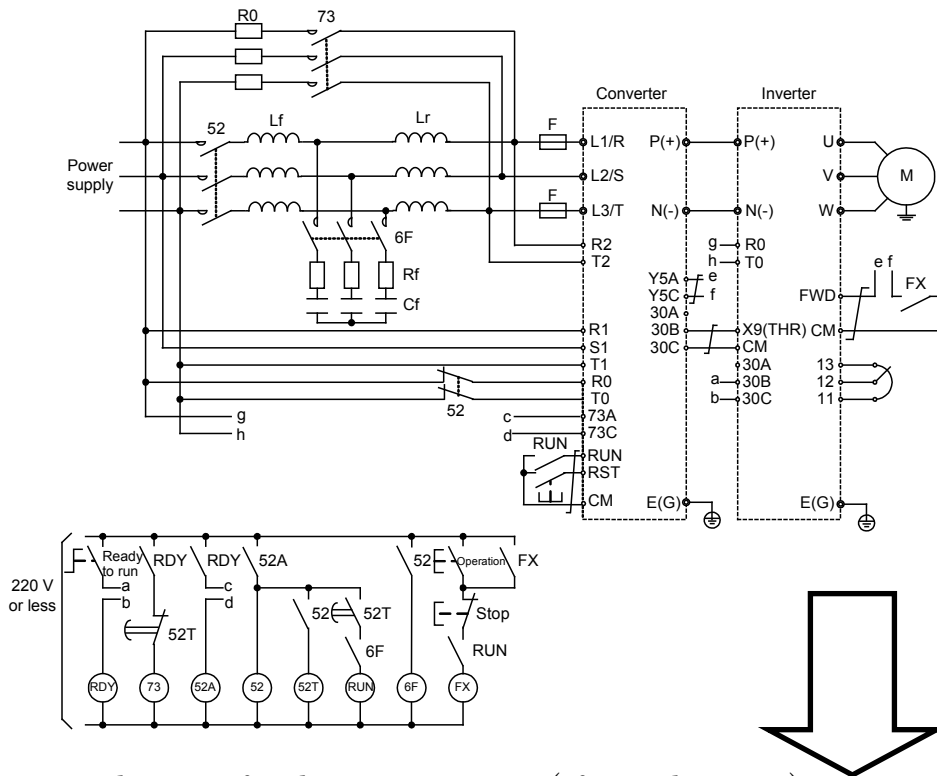

Connection diagram of replacement inverters (after replacement)

Change the connection marked with .

- 1) Auxiliary control power input terminals (R0, T0)
Be sure to connect these terminals to the main power supply *via normally-closed contacts* of the magnetic contactor (52) for the power supply circuit.
- 2) Auxiliary main circuit power input terminals (R1, T1), exclusive to inverters equipped with R1 and T1
Be sure to connect these terminals to the main power supply *without passing through normally-closed contacts* of the magnetic contactor (52) for the power supply circuit.

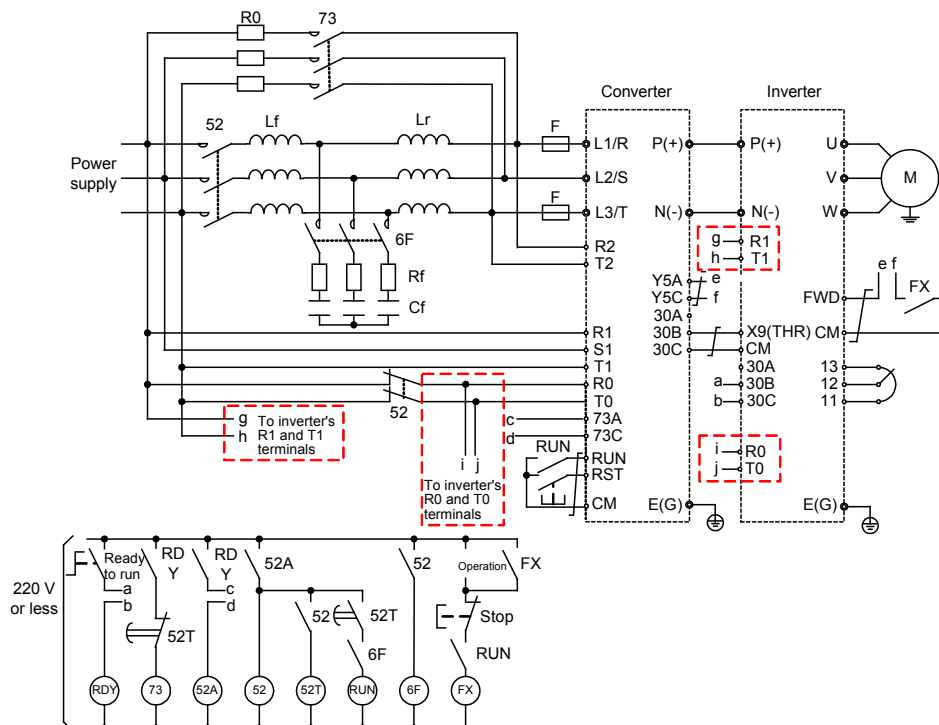

FRENIC-HVAC

User's Manual

First Edition, February 2014
Fifth Edition, May 2016

Fuji Electric Co., Ltd.

The purpose of this manual is to provide accurate information in the handling, setting up and operating of the FRENIC-HVAC series of inverters. Please feel free to send your comments regarding any errors or omissions you may have found, or any suggestions you may have for generally improving the manual.

In no event will Fuji Electric Co., Ltd. be liable for any direct or indirect damages resulting from the application of the information in this manual.

 Fuji Electric Co., Ltd.

Gate City Ohsaki, East Tower, 11-2, Osaki 1-chome, Shinagawa-ku, Tokyo 141-0032, Japan
Phone : (03)5435-7111

Internet address : <http://www.fujielectric.co.jp>

Information in this manual is subject to change without notice.