

Low Voltage Industrial Controls

New WEG MPW18 & MPW40 Manual Motor Protectors

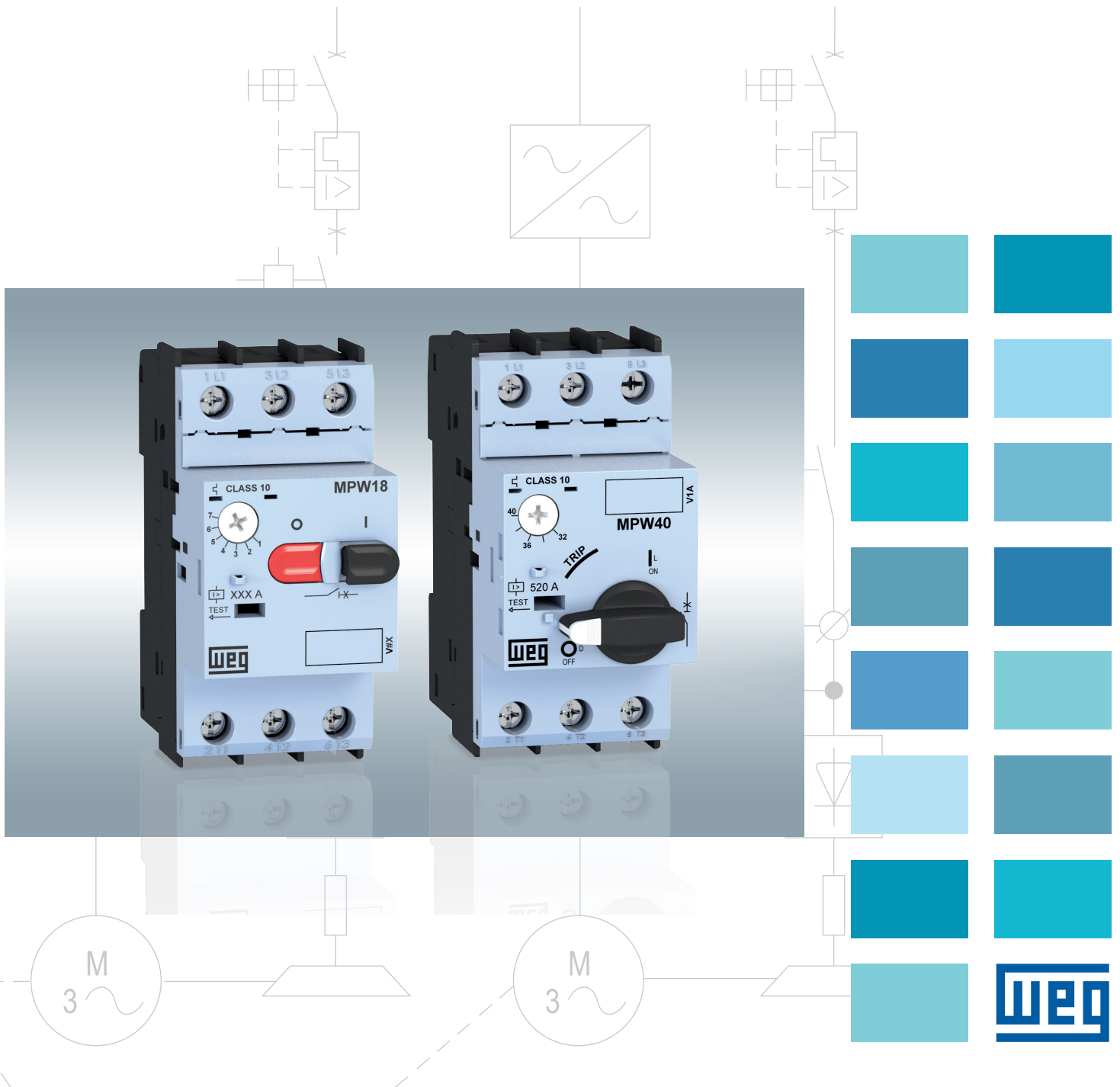

Manual Motor Protectors

WEG MPW18 AND MPW40

MPW18 & 40 Part Number Structure	C-3
MPW18 Selection Table and Pricing	C-3
MPW40 Selection Table and Pricing	C-4
MPW18 Overview	C-5
MPW40 Overview	C-6
Accessories	C-7
Technical Data	C-11
Breaking Capacities	C-14
Curves	C-15
Diagrams and Dimensions	C-16

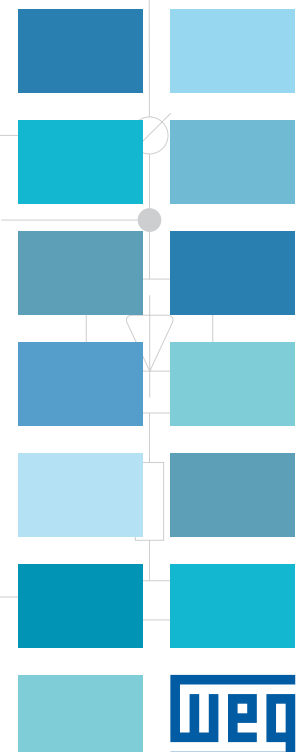

New WEG MPW Motor Circuit Breakers

Developed according to IEC 60947 and UL 508 international standards, the new WEG MPW line of motor protective circuit breakers are modular and compact but at the same time robust and highly reliable, meeting the expectations of the most demanding users.

The MPWs are designed with the visual identity of WEG, a brand recognized worldwide for its quality.



MPW18

- Motor protective circuit breaker up to 18 A
- Thermal-magnetic circuit breaker (provides protection against short-circuit and overload) or only magnetic circuit breaker (provides protection against short-circuit)
- Same technical features (mechanical and electrical) of former MPW16 (up to 16 A)
- Pushbutton operated

MPW40

- Motor protective circuit breaker up to 40 A - 45 mm wide
- Thermal-magnetic circuit breaker (provides protection against short-circuit and overload) or only magnetic circuit breaker (provides protection against short-circuit)
- Same technical features (mechanical and electrical) of former MPW25 (up to 32 A)
- Rotary handle operated



MPW18/40 Catalog Number Structure

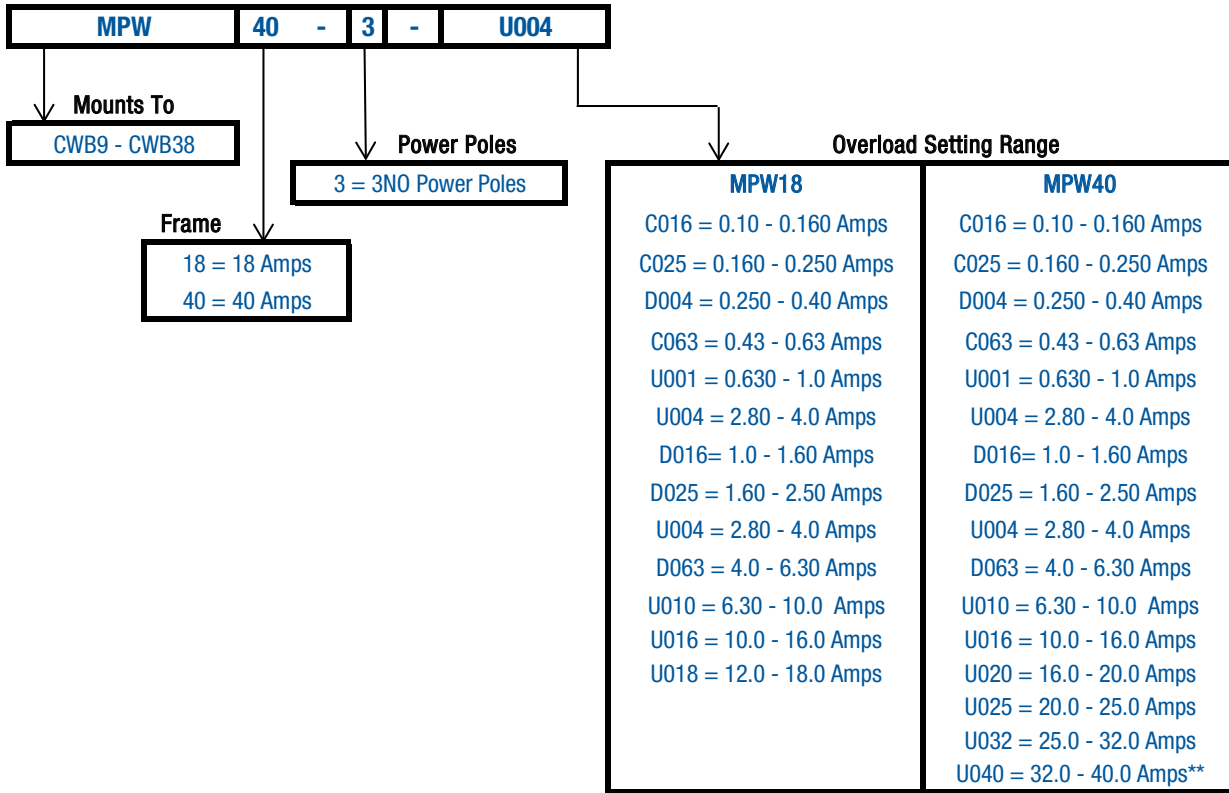

*For Reference only. Not intended to create part numbers.

MPW18 Manual Motor Protector - Selection Table

MPW18 Motor Protective Circuit Breaker up to 18 A (Screw Terminal) - Thermomagnetic or Magnetic Only

- With overload and short-circuit protection
- Fixed short-circuit release 13 x lu
- With phase-failure sensitivity according to IEC 60947-4-1
- With temperature compensation
- For use as main switch (IEC 60947-2)
- Pushbutton operated



Maximum UL Horsepower						Thermal Setting	Short-Circuit interruption capacity		Catalog Number	List Price	Multiplier Symbol
Single Phase		Three Phase					[A]	480V			
115V	230V	200V	230V	460V	575V						
-	-	-	-	-	-	0.10 - 0.16	50kA	10kA	MPW18-3-C016	\$97	Z4
-	-	-	-	-	-	0.16 - 0.25	50kA	10kA	MPW18-3-C025	\$97	Z4
-	-	-	-	-	-	0.25 - 0.40	50kA	10kA	MPW18-3-D004	\$97	Z4
-	-	-	-	-	-	0.40 - 0.63	50kA	10kA	MPW18-3-C063	\$105	Z4
-	-	-	-	-	1/2	0.63 - 1.0	50kA	10kA	MPW18-3-U001	\$105	Z4
-	1/10	-	-	3/4	3/4	1.0 - 1.6	50kA	10kA	MPW18-3-D016	\$105	Z4
-	1/6	1/2	1/2	1	1 1/2	1.6 - 2.5	50kA	10kA	MPW18-3-D025	\$105	Z4
1/8	1/3	3/4	3/4	2	3	2.5 - 4.0	50kA	10kA	MPW18-3-U004	\$105	Z4
1/4	1/2	1	1 1/2	3	5	4.0 - 6.3	50kA	10kA	MPW18-3-D063	\$105	Z4
1/2	1 1/2	2	3	5	7 1/2	6.3 - 10	50kA	5kA	MPW18-3-U010	\$105	Z4
1	2	3	5	10	10	10 - 16	30kA	5kA	MPW18-3-U016	\$105	Z4
1	3	5	5	10	15	12 - 18	30kA	5kA	MPW18-3-U018	\$120	Z4

Note: Horsepower ratings shown in the table are for reference only. Please refer to the Full Load Amps of the Motor for final selection.

MPW40 Manual Motor Protector - Selection Table

MPW40 Motor Protective Circuit Breaker up to 40 A (Screw Terminal) - Thermomagnetic Only

- With overload and short-circuit protection
- Fixed short-circuit release 13 x lu
- With phase-failure sensitivity according to IEC 60947-4-1
- With temperature compensation
- For use as main switch (IEC 60947-2)
- Rotary handle operated



MPW40-PRODUCT SELECTION

Maximum UL Horsepower						Thermal Setting	Short-Circuit interruption capacity		Catalog Number	List Price	Multiplier Symbol
Single Phase		Three Phase					[A]	480V			
115V	230V	200V	230V	460V	575V						
-	-	-	-	-	-	0.10 - 0.16	50kA	25kA	MPW40-3-C016	\$116	Z4
-	-	-	-	-	-	0.16 - 0.25	50kA	25kA	MPW40-3-C025	\$116	Z4
-	-	-	-	-	-	0.25 - 0.40	50kA	25kA	MPW40-3-D004	\$116	Z4
-	-	-	-	-	1/4	0.40 - 0.63	50kA	25kA	MPW40-3-C063	\$137	Z4
-	-	-	-	1/2	1/2	0.63 - 1.0	50kA	25kA	MPW40-3-U001	\$137	Z4
-	1/10	1/4	1/3	3/4	1	1.0 - 1.6	50kA	25kA	MPW40-3-D016	\$137	Z4
-	1/6	1/2	1/2	1 1/2	1 1/2	1.6 - 2.5	50kA	25kA	MPW40-3-D025	\$137	Z4
1/8	1/3	3/4	1	2	3	2.5 - 4.0	50kA	25kA	MPW40-3-U004	\$137	Z4
1/4	3/4	1 1/2	1 1/2	3	5	4.0 - 6.3	50kA	25kA	MPW40-3-D063	\$137	Z4
1/2	1 1/2	3	3	5	7 1/2	6.3 - 10	50kA	25kA	MPW40-3-U010	\$137	Z4
1	3	5	5	10	15	10 - 16	50kA	25kA	MPW40-3-U016	\$150	Z4
1 1/2	3	5	7 1/2	15	15	16 - 20	50kA	25kA	MPW40-3-U020	\$150	Z4
2	3	7 1/2	7 1/2	15	20	20 - 25	50kA	25kA	MPW40-3-U025	\$170	Z4
-	5	10	10	20	25	25 - 32	42kA	25kA	MPW40-3-U032	\$190	Z4
-	5	10	15	25	-	32 - 40	20kA	0kA	MPW40-3-U040**	\$225	Z4

Note: Horsepower ratings shown in the table are for reference only. Please refer to the Full Load Amps of the Motor for final selection.

MPW40 with current limiter block (CLT25) - PRODUCT SELECTION

Maximum UL Horsepower						Thermal Setting	Short-Circuit interruption capacity		Individual Component Catalog Number ¹				Multiplier Symbol
Single Phase		Three Phase					[A]	480V	600V	Catalog Number		List Price	
115V	230V	200V	230V	460V	575V						Catalog Number	List Price	Catalog Number
-	-	-	-	-	-	0.10 - 0.16	100kA	50kA	MPW40-3-C016	\$116	CLT32 MPW40	\$100	Z4
-	-	-	-	-	-	0.16 - 0.25	100kA	50kA	MPW40-3-C025	\$116	CLT32 MPW40	\$100	Z4
-	-	-	-	-	-	0.25 - 0.40	100kA	50kA	MPW40-3-D004	\$116	CLT32 MPW40	\$100	Z4
-	-	-	-	-	1/4	0.40 - 0.63	100kA	50kA	MPW40-3-C063	\$137	CLT32 MPW40	\$100	Z4
-	-	-	-	1/2	1/2	0.63 - 1.0	100kA	50kA	MPW40-3-U001	\$137	CLT32 MPW40	\$100	Z4
-	1/10	1/4	1/3	3/4	1	1.0 - 1.6	100kA	50kA	MPW40-3-D016	\$137	CLT32 MPW40	\$100	Z4
-	1/6	1/2	1/2	1 1/2	1 1/2	1.6 - 2.5	100kA	50kA	MPW40-3-D025	\$137	CLT32 MPW40	\$100	Z4
1/8	1/3	3/4	1	2	3	2.5 - 4.0	100kA	50kA	MPW40-3-U004	\$137	CLT32 MPW40	\$100	Z4
1/4	3/4	1 1/2	1 1/2	3	5	4.0 - 6.3	100kA	50kA	MPW40-3-D063	\$137	CLT32 MPW40	\$100	Z4
1/2	1 1/2	3	3	5	7 1/2	6.3 - 10	100kA	50kA	MPW40-3-U010	\$137	CLT32 MPW40	\$100	Z4
1	3	5	5	10	15	10 - 16	100kA	50kA	MPW40-3-U016	\$150	CLT32 MPW40	\$100	Z4
1 1/2	3	5	7 1/2	15	15	16 - 20	100kA	50kA	MPW40-3-U020	\$150	CLT32 MPW40	\$100	Z4
2	3	7 1/2	7 1/2	15	20	20 - 25	100kA	50kA	MPW40-3-U025	\$170	CLT32 MPW40	\$100	Z4
-	5	10	10	20	25	25 - 32	100kA	50kA	MPW40-3-U032	\$190	CLT32 MPW40	\$100	Z4

Note: Horsepower ratings shown in the table are for reference only. Please refer to the Full Load Amps of the Motor for final selection.

¹ Individual Component Catalog Numbers are ordered separately.

** UL Certification Pending (32.0-40.0 Unit)

MPW18 Manual Motor Protector - Overview

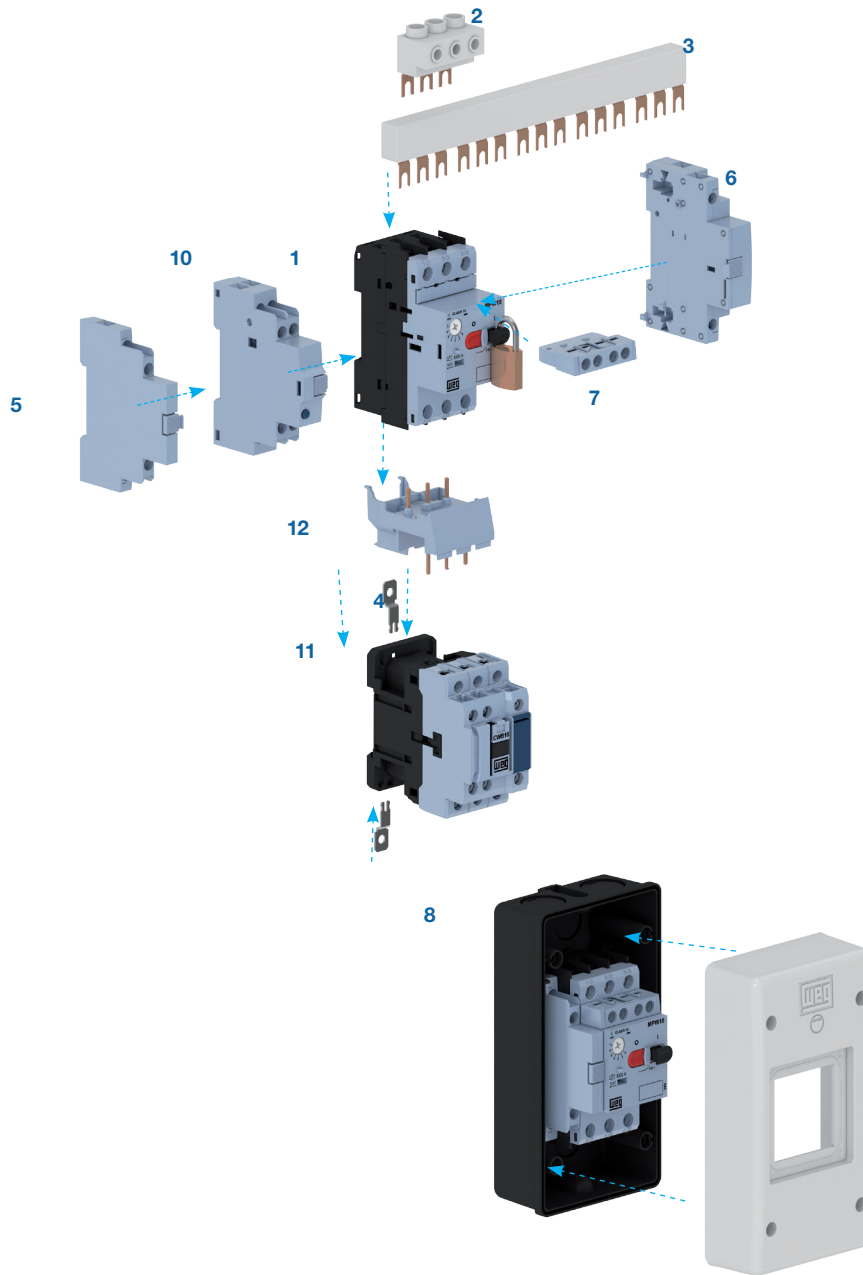

- 1 - MPW18 motor protective circuit breaker (screw terminal)
- 2 - Feeder terminal FTBBS
- 3 - Three-phase busbars BBS
- 4 - Push-in-lugs PLMP
- 5 - Side mounted auxiliary contact block ACBS (screw terminal)
- 6 - Undervoltage release URMP or shunt release SRMP (screw terminal)
- 7 - Front mounted auxiliary contact block ACBF (screw terminal)
- 8 - Insulated enclosure PE66GN

- 9 - Scale cover SCMP
- 10 - Trip signaling block TSB
- 11 - CWB9...38 contactors
- 12 - Link module ECCMP-18B38 (MPW18+CWB9...38)

MPW40 Manual Motor Protector - Overview

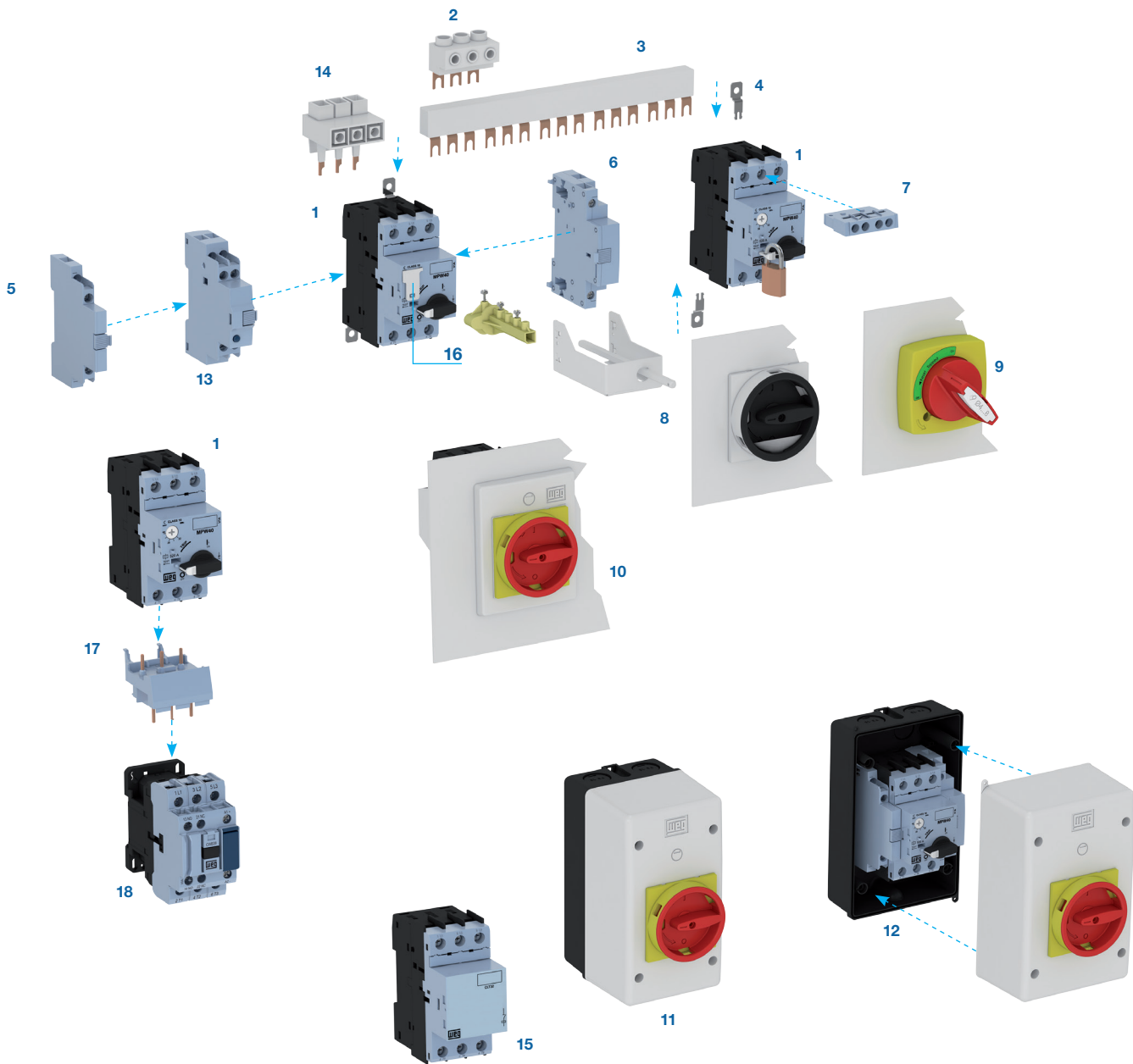

- 1 - MPW40 motor protective circuit breaker (screw terminal)
- 2 - Feeder terminal FTBBS
- 3 - Three-phase busbars BBS
- 4 - Push-in-lugs PLMP
- 5 - Side mounted auxiliary contact block ACBS (screw terminal)
- 6 - Undervoltage release URMP or shunt release SRMP (screw terminal)
- 7 - Front mounted auxiliary contact block ACBF (screw terminal)
- 8 - Door coupling rotary handle RMMP
- 9 - Door coupling rotary handle MRX

- 10 - Front plate FME55
- 11 - Standard insulated enclosure PE55GN-E
- 12 - Large insulated enclosure LPE55GN-3
- 13 - Trip signaling block TSB
- 14 - LST25 - Feeder terminal for "Type E" motor starter according to UL
- 15 - Current limiter CLT32 MPW40
- 16 - Scale cover SCMP
- 17 - Link module ECCMP-40B38 (MPW40+CWB9...38)
- 18 - CWB9...38 contactors

MPW Manual Motor Protector - Accessories

Front Auxiliary Contact Block - ACBF

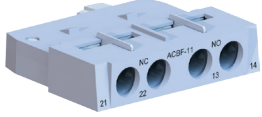
For use with		Auxiliary contacts		Catalog #	List Price
		NO	NC		
MPW18 MPW40		1	1	ACBF-11-B	\$20.00

Left Side Auxiliary Contact Block - ACBS

For use with		Auxiliary contacts		Catalog #	List Price
		NO	NC		
MPW18 MPW40 ¹⁾		1	1	ACBS-11-B	\$22.00
		2	-	ACBS-20-B	
		-	2	ACBS-02-B	

Trip Signalling Block - TSB²⁾

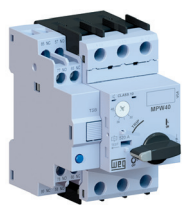
For use with		Description	Catalog #	List Price
MPW18 MPW40		<ul style="list-style-type: none"> - Equipped with 2 auxiliary contacts (1NO + 1NC) for overload trip signalling and 2 other auxiliary contacts (1NO + 1NC) for short-circuit trip signaling; - To reset the circuit breaker after a short-circuit, the flag must be manually reset after the cause of the failure has been solved; - Lateral auxiliary contacts can be assembled together with the trip signalling block; - Left side assembly only. 	TSB-22-B	\$38.00

Undervoltage Release - URMP¹⁾

For use with		Description	Voltage and frequency ²⁾	Catalog #	List Price
MPW12/18 MPW40		<ul style="list-style-type: none"> - Operating voltage: >0.85...1.1 x Ue - Non operating voltage: <0.35...0.7 x Ue - Right side assembly 	220 V 50/60 Hz	URMP D23-B	\$56.00
			24 V 50/60 Hz	URMP D02-B	
			110 V 50 Hz / 120 V 60 Hz	URMP V18-B	
			180 V 50 Hz / 208 V 60 Hz	URMP V23-B	
			208 V 50 Hz / 240 V 60 Hz	URMP V30-B	
400-415 V 50 Hz / 480 V 60 Hz	URMP V47-B				

Shunt Release - SRMP¹⁾

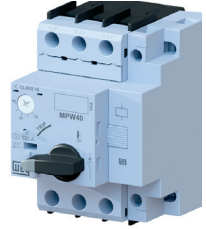
For use with		Description	Voltage and frequency ²⁾	Catalog #	List Price
MPW12/18 MPW40 ¹⁾		<ul style="list-style-type: none"> - Operating voltage: 0.7...1.1 x Ue - Right side assembly 	20-24 V 50/60 Hz	SRMP D51-B	\$56.00
			100-127 V 50/60 Hz	SRMP D59-B	
			200-240 V 50/60 Hz	SRMP D65-B	

Notes: 1) TSB, URMP, AND SRMP are only available with screw terminals.

The following accessories can be assembled at the same time: ACBF + URMP/SRMP + TSB or ACBS + URMP/SRMP + TSB.

MPW Manual Motor Protector - Accessories

Connector Links for MPW18/40 & CWB Contactors

For use with		Description	Contactors	Catalog #	List Price
MPW18		For direct connection (electrical and mechanical) of motor circuit breakers to contactors.	CWB9...38 AC coil	ECCMP-18B38	\$20.00
MPW40			CWB9...38 AC coil	ECCMP-40B38	\$25.00
			CWB9...38 DC coil	ECCMP-40B38DC	

Rotary Handles & Mechanism

For use with		Description	Handle color	Catalog #	List Price
MPW40		<ul style="list-style-type: none"> - Degree of protection IP55/NEMA 1 - Shows circuit breaker position "I"(ON) or "O"(OFF); - Panel door can only be opened in OFF position; - Adjustable shaft length. There are 2 standard shaft sizes: 130-155 mm (Model 130) and 330-355 mm (Model 330). To assemble the handle on the circuit breaker the shaft must have a length of at least 80 mm; - Up to 3 padlocks can be used in the OFF position. This blocks circuit breaker operation and opens panel door; - Handle can be mounted on panels with a thickness of 1 to 5 mm; - Handle can be assembled even with circuit breaker turned in 90° position. 	Black	RMMP-130	\$60.00
				RMMP-330	\$70.00
			Red	RMMP-130E	\$60.00
				RMMP-330E	\$70.00
MPW40		<ul style="list-style-type: none"> - Panel door can be opened in ON position (thermometry); - Degree of protection: MRX = IP65/NEMA 4X; - Shows circuit breaker position "I"(ON) or "O"(OFF); - Adjustable shaft length. There are 2 standard shaft sizes: 130-155 mm (Model 130) and 330-355 mm (Model 330). To assemble the handle ON the circuit breaker the shaft must have a length of at least 80 mm; - Up to 3 padlocks can be used in the OFF position. This blocks circuit breaker operation and opens panel door; - Handle can be mounted on panels with a thickness of 1 to 5 mm. 	Black	MRX-130	\$105.00
				MRX-330	\$115.00
			Red	MRX-130E	\$105.00
				MRX-330E	\$115.00

Standard Insulated Enclosure - MPE

For use with	Picture	Description	Terminals	Handle color	Catalog #	List Price
MPW18		<ul style="list-style-type: none"> - Empty plastic enclosure; - Degree of protection: IP66; - Two M25 metric cable entry knockouts, top and bottom; - Two M20 metric cable entry, back; - Allows installing: MPW + ACBF11/PL lamps + ACBS; - Color: cover (grey RAL 7035) and base (black RAL 7021). 	Ground and neutral	-	PE66GN	\$45.00
MPW40		<ul style="list-style-type: none"> - Empty plastic enclosure; - Protection degree IP55; - Allows installing: MPW + ACBF11/PL lamps + ACBS; - Two M25 metric cable entry knockouts, top and bottom; - Two M20 metric cable entry, back; - Rotary handle on the cover connected on MPW's handle; - Handle can be locked with up to 3 padlocks in the OFF position; - Color: cover (grey RAL 7035) and base (black RAL 7021). 	Ground and neutral	Black	PE55GN	\$45.00
				Red	PE55GN-E	\$45.00

MPW Manual Motor Protector - Accessories

Large Insulated Enclosure - MLPE

For use with	Picture	Description	Terminals	Handle color	Catalog #	List Price
MPW40		<ul style="list-style-type: none"> - Empty plastic enclosure; - Protection degree IP55; - Allows installing: MPW + ACBF11/PL lamps + ACBS /TSB + URMP/SRMP; - Two M25 metric cable entry knockouts, top and bottom; - Two M20 metric cable entry, back; - Rotary handle on the cover connected on MPW's handle; - Handle can be locked with up to 3 padlocks in the OFF position; - Color: cover (grey RAL 7035) and base (black RAL 7021). 	Ground and neutral	Black	LPE55GN	\$55.00
				Red	LPE55GN-E	

Manual Motor Protector Mounting Plate Adapter

For use with	Picture	Description	Contactors	Catalog #	List Price
MPW18 MPW40		<ul style="list-style-type: none"> - Used for direct on line starters; - Adapter fixed by screws or DIN rail 35 mm; - 45 mm width; - Motor protective circuit breaker + contactors: connection by cables. 	CWB9...38	MA45DOL	\$40.00
MPW18 MPW40		<ul style="list-style-type: none"> - Used for reversing starters; - Adapter fixed by screws or DIN rail 35 mm; - 90 mm width; - Motor protective circuit breaker + contactors: connection by cables. 	2 x CWB9...38	MA90RVS	\$50.00
MPW18 MPW40		<ul style="list-style-type: none"> - Used for star-delta starters; - Adapter fixed by screws or DIN rail 35 mm; - 90 mm width; - Motor protective circuit breaker + contactors: connection by cables. 	CWB9...38	MA90SDS	\$50.00

Three-Phase Feeder Terminals

For use with	Picture	Description	Catalog #	List Price
MPW18 MPW40		<ul style="list-style-type: none"> - For feeding the busbars; - Rated insulation voltage: 690 V ac; - Ie = 63 A; - Terminals: 6-25 mm² rigid wire and 6-16 mm² flexible wire with terminal. 	FTBBS	\$35.00
MPW40		<ul style="list-style-type: none"> - Block module for Type E combination motor controller in accordance with UL (LST25+MP-W+TSB); - Rated insulation voltage: 690 V ac; - Ie = 63 A; - Terminals: 8-20 AWG. 	LST25	\$30.00

MPW Manual Motor Protector - Accessories

Current Limiter

For use with		Description	Catalog #	List Price
MPW40		<ul style="list-style-type: none"> - For protecting electrical circuits where high short-circuit breaking capacity is required: 100 kA @ 500 V ac. <p><i>Note: this accessory must be used together with a MPW motor protective circuit breaker up to 32 A.</i></p>	CLT32 MPW40	\$100.00

Three-Phase Busbars for Circuit Breakers Without Side Fitted Auxiliary Contacts

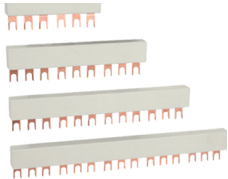
For use with		Description	Number of circuit breakers	Catalog #	List Price
MPW18 MPW40		<ul style="list-style-type: none"> - For parallel blocking of side-by-side mounted circuit breakers; - Without side auxiliary contacts; - Enables the use of frontal auxiliary contact block ACBF-11; - Rated insulation voltage: 690 V ac; - Ie = 63 A. 	2	BBS45-2	\$32.00
			3	BBS45-3	\$35.00
			4	BBS45-4	\$45.00
			5	BBS45-5	\$60.00

Three-Phase Busbars for Motor Protective Circuit Breakers with Side Fitted Auxiliary Contacts - BBS54

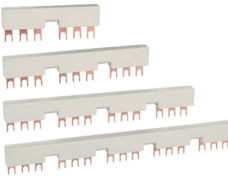
For use with		Description	Number of circuit breakers	Catalog #	List Price
MPW18 MPW40		<ul style="list-style-type: none"> - For parallel connection of circuit breakers with screw terminals mounted side-by-side; - Enables the use of side auxiliary contact block ACBS mounted on each motor protective circuit breaker; - Rated Insulation Voltage: 690 V ac; - Ie = 63 A. 	2	BBS54-2	\$32.00
			3	BBS54-3	\$35.00
			4	BBS54-4	\$45.00
			5	BBS54-5	\$60.00

Shrouded for Unused Terminals - CSD

For use with		Description	Catalog #	List Price
BBS45 and BBS54		<p>Protection against direct contact in energized terminals without the use of busbars BBS.</p> <p><i>NOTE: Sold in packs of 6 ea.</i></p>	CSD	\$10.00

Scale Cover - SCMP

For use with		Description	Catalog #	List Price
MPW12...18 MPW40		Protects the current adjustment dial against direct contact while enabling the adjusted current to be viewed.	SCMP	\$5.00

Push-In-Lugs - PLMP

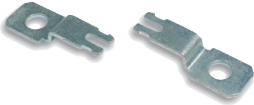
For use with		Description	Catalog #	List Price
MPW12...18 MPW40		<p>For direct assembly of motor protective circuit breaker into any surface using screws.</p> <p><i>NOTE: Sold in packs of 2 ea.</i></p>	PLMP	\$0.50

MPW Manual Motor Protectors - Technical Data

Models		MPW18	MPW40	
Maximum rated current I_{max} (Ie)		18 A	40 A	
Number of poles		3	3	
Short-circuit release		$13xI_{e,max}$	$13xI_{e,max}$	
Rated operational voltage U_e		690 V ¹⁾	690 V ¹⁾	
Rated frequency		50/60 Hz	50/60 Hz	
Rated insulation voltage U_i		690 V	690 V	
Rated impulse withstand voltage U_{imp}		6 kV	6 kV	
Use category	IEC 60947-2 (circuit breaker)	A	A	
	IEC 60947-4-1 (motor starter)	AC-3	AC-3	
Tripping test		Yes	Yes	
Overload protection		Yes	Yes	
Phase failure sensitivity (IEC 60947-4-1)		Yes	Yes	
Tripping indication		No	Yes	
Tripping class (IEC 60947-4-1)		10	10	
Maximum operation per hour	Operations/hour	15	15	
Altitude (m)		2000	2000	
Degree of protection (IEC 60529)		IP20	IP20	
Mechanical life	Number of operations	100000	100000	
Electrical life	Number of operations	100000	100000	
Permissible ambient temperature				
Transport and storage		-50...+80 °C	-50...+80 °C	
Operation ²⁾		-20...+70 °C	-20...+70 °C	
Temperature compensation (IEC 60947-4-1)		-20...+60 °C	-20...+60 °C	
Power dissipation per circuit breaker				
Maximum rated currents I_n	≤ 10 A	7 W	7 W	
	≤ 12 A ³⁾	7 W	--	
	≤ 16 A	8 W	8 W	
	≤ 18 A	7 W	--	
	≤ 20 A	--	9 W	
	≤ 25 A	--	15 W	
	≤ 32 A	--	15 W	
Resistance to impact (IEC 60068-2-27)		15 g	15 g	
Standards				
IEC 60947-1		Yes		
IEC 60947-2		Yes		
IEC 60947-4-1		Yes		
Connection				
Type of terminal		Spring	Screws Phillips (N° 2)	Screws Phillips (N° 2)
Tightening torque	N.m	-	1.2...1.7	2...2.5
	lb.in	-	11...16	18...22
Dimensions				
Width (mm)		45	45	
Height (mm)		100	90	
Depth (mm)		77	77	

Notes: 1) 500 V with plastic enclosure.

2) Reduce current for temperatures exceeding +60 °C (87% to 70 °C).

3) Only available with spring terminal.

Altitude - Correction Factor

The MPW motor protective circuit breakers do not undergo any change to their specified performance when applied at an altitude of up to 2000 meters above sea level.

However, as the altitude increases, the atmospheric properties vary in terms of dielectric rigidity and pressure.

Therefore, current and voltage correction factors must be applied for altitudes exceeding 2000 meters, as shown in the following table:

Altitude (above sea level) - h	Rated operational voltage U_e	Current correction factor I_u
$h \leq 2000$ m	690 V	$1 \times I_n$
$2000 < h \leq 3000$ m	550 V	$0.96 \times I_n$
$3000 < h \leq 4000$ m	480 V	$0.93 \times I_n$
$4000 < h \leq 5000$ m	420 V	$0.90 \times I_n$

MPW Manual Motor Protectors - Technical Data

Main Terminal Capacity

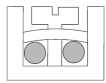
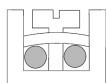
Models	Type	Number of conductors	Cross-section
MPW18	Rigid or flexible cable	 1 or 2	1...4 mm ² 18...12 AWG
MPW40	Rigid or flexible cable	 1 or 2	1...2.5 mm ² 2.5...6 mm ² 14...8 AWG ²⁾

Auxiliary Contact Blocks - ACB

Reference	ACBF-11			ACBS- __ , TSB			
For use with	MPW18 & MPW40						
Rated insulation voltage Ui	250 V			690 V			
Utilization category	24 Vac	220-230 Vac	24 V ac	230 V ac	400 V ac	690 V ac	
AC-15	2 A	0.5 A	6 A	6 A	3 A	1 A	
AC-12	2.5 A		2.5 A	10 A	10 A	10 A	10 A
DC-13	24 V d	48 V dc	60 V dc	24 V dc	110 V dc	220 V dc	440 V dc
	1 A	0.3 A	0.15 A	2 A	0.5 A	0.25 A	0.1 A
Type of terminal	Flat		Spring	Flat			Spring
Type of screw	Phillips (N° 2)		-	Phillips (N° 2)			-
Tightening torque	1...1.5 N.m (7...10 lb.in)		-	1...1.5 N.m (7...10 lb.in)			-
Rigid cable	1 or 2 x (0.5...1.5 mm ²) 1 or 2 x (0.75...2.5 mm ²) 1 or 2 x (18...14 AWG)	1 or 2 x (1...1.5 mm ²) 1 or 2 x (18...16 AWG)	1 or 2 x (0.5...1.5 mm ²) 1 or 2 x (0.75...2.5 mm ²) 1 or 2 x (18...14 AWG)			1 or 2 x (1...1.5 mm ²) 1 or 2 x (18...16 AWG)	
Flexible cable		-				-	
Finely stranded with end sleeve ¹⁾	1 or 2 x (1 mm ²) 1 or 2 x (18 AWG)					1 or 2 x (1 mm ²) 1 or 2 x (18 AWG)	
Backup fuses gL/gG	10 A						

Undervoltage Release - URMP

Reference	URMP
For use with	MPW18 & MPW40
Rated insulation voltage Ui	690 V
Operating voltage (enables cir. breaker switch ON)	0.85...1.1 x Ue
Non-operating voltage (guarantees circuit breaker switch OFF)	0.35...0.7 x Ue
Energization consumption	20.2 VA / 13 W
Consumption	7.2 VA / 2.4 W
Max. opening time	20 ms
Type of terminal	Flat
Type of screws	Phillips (N° 2)
Tightening torque	1...1.5 N.m (7...10 lb.in)
Rigid cable	1 or 2 x (0.5...1.5 mm ²) 1 or 2 x (0.75...2.5 mm ²) 1 or 2 x (18...14 AWG)
Flexible cable	
Backup fuses gL/gG	10 A

Notes: 1) Mandatory use (finely stranded cable without end sleeve is not allowed).

2) 8 AWG for flexible cable only.

MPW Manual Motor Protectors - Technical Data

Shunt Release - SRMP

Reference codes	SRMP
For use with	MPW18 & MPW40
Rated insulation voltage Ui	690 V
Operating voltage (guarantee cir. breaker switch OFF)	0.7...1.1 x Ue
Energization consumption	20.2 VA / 13 W
Max. opening time	20 ms
Type of terminal	Flat
Type of screws	Phillips (N° 2)
Tightening torque	1...1.5 N.m (7...10 lb.in)
Rigid cable	1 or 2 x (0.5...1.5 mm ²)
Flexible cable	1 or 2 x (0.75...2.5 mm ²)
Backup fuses gL/gG	10 A

Mounting Configurations for MPW Motor Protective Circuit Breaker

Live or grounded parts distance to the circuit breaker				
Model	Ue	Minimum distance between the circuit breaker and live or grounded parts (mm)		
		B	C	A
MPW18	Up to 690 V	20	75	9
MPW40	Up to 500 V	30	95	9
	Up to 690 V	50	95	30

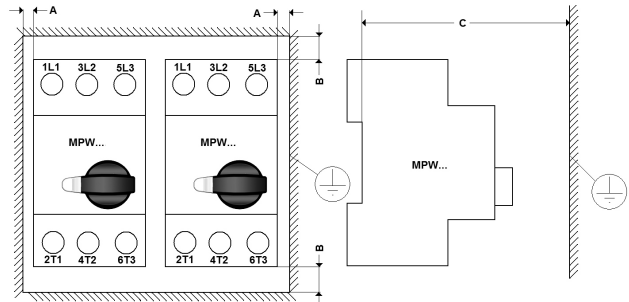

The motor protective circuit breaker can be mounted in any position, but according to IEC 60447 standard, the "On - I" indicator must be to the right, or up.

MPW Manual Motor Protectors - Rated Short-Circuit Breaking Capacity (IEC 60947-2)

MPW18 & MPW40

Models	Setting overload release (A)	220-230 V ac		380-415 V ac		440 V ac		460-500 V ac		630-690 V ac	
		Icu	Ics	Icu	Ics	Icu	Ics	Icu	Ics	Icu	Ics
		kA	kA	kA	kA	kA	kA	kA	kA	kA	kA
MPW12...18	0.10...0.16	100	100	100	100	100	100	100	100	10	10
	0.16...0.25	100	100	100	100	100	100	100	100	10	10
	0.25...0.4	100	100	100	100	100	100	100	100	10	10
	0.4...0.63	100	100	100	100	100	100	100	100	10	10
	0.63...1	100	100	100	100	100	100	100	100	10	10
	1...1.6	100	100	100	100	100	100	100	100	10	10
	1.6...2.5	100	100	100	100	100	100	100	100	8	8
	2.5...4	100	100	100	100	100	100	100	100	8	8
	4...6.3	100	100	100	100	100	100	100	100	8	8
	6.3...10	100	100	50	10	50	10	10	10	5	5
	10...16	100	100	10	10	10	10	10	8	4	3
12...18	100	100	10	10	10	10	10	8	4	3	
MPW40	0.10...0.16	100	100	100	100	100	100	100	100	100	100
	0.16...0.25	100	100	100	100	100	100	100	100	100	100
	0.25...0.4	100	100	100	100	100	100	100	100	100	100
	0.4...0.63	100	100	100	100	100	100	100	100	100	100
	0.63...1	100	100	100	100	100	100	100	100	100	100
	1...1.6	100	100	100	100	100	100	100	100	100	100
	1.6...2.5	100	100	100	100	100	100	100	100	8	8
	2.5...4	100	100	100	100	100	100	100	100	8	8
	4...6.3	100	100	100	100	100	100	100	100	8	8
	6.3...10	100	100	100	100	50	25	42	21	8	8
	10...16	100	100	50	25	50	15	10	8	5	5
	16...20	100	100	50	25	50	15	10	8	5	5
	20...25	100	100	50	25	50	15	10	8	5	5
	25...32	100	100	50	25	25	15	10	8	5	5
32...40	100	100	30	15	20	10	10	5	5	2	

MPW Manual Motor Protectors + CLT32 Current Limiter Rated Short-Circuit Breaking Capacity (IEC 60947-2)

MPW40+CLT32 MPW40

Model	Setting overload release (A)	380-415 V ac		440 V ac		460-500 V ac		630-690 V ac	
		Icu	Ics	Icu	Ics	Icu	Ics	Icu	Ics
		kA	kA	kA	kA	kA	kA	kA	kA
MPW40 +CLT32 MPW40	0.10...0.16	◆	◆	◆	◆	◆	◆	◆	◆
	0.16...0.25	◆	◆	◆	◆	◆	◆	◆	◆
	0.25...0.4	◆	◆	◆	◆	◆	◆	◆	◆
	0.4...0.63	◆	◆	◆	◆	◆	◆	◆	◆
	0.63...1	◆	◆	◆	◆	◆	◆	◆	◆
	1...1.6	◆	◆	◆	◆	◆	◆	◆	◆
	1.6...2.5	◆	◆	◆	◆	◆	◆	50	50
	2.5...4	◆	◆	◆	◆	◆	◆	50	50
	4...6.3	◆	◆	◆	◆	◆	◆	50	50
	6.3...10	◆	◆	100	100	100	100	50	50
	10...16	100	100	100	100	100	100	50	50
	16...20	100	100	100	100	100	100	50	50
	20...25	100	100	100	100	100	100	10	10
	25...32	100	100	100	100	100	100	10	10

MPW Manual Motor Protectors - Characteristics Curves

The tripping characteristic shows the motor circuit breaker trip time in relation to the rated current.

The curves show average tolerance range values for an ambient temperature of 20 °C, starting in cold state. Thermal trip time when working in operating temperature is reduced to around 25% of the presented values. Under normal operating conditions, all 3 circuit breaker phases must be conducting.

MPW18 & MPW40

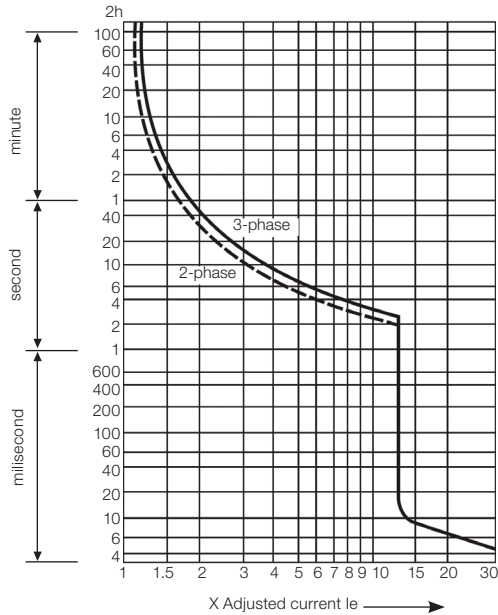

Short-Circuit Current Limitation Curve at 440 V - MPW40

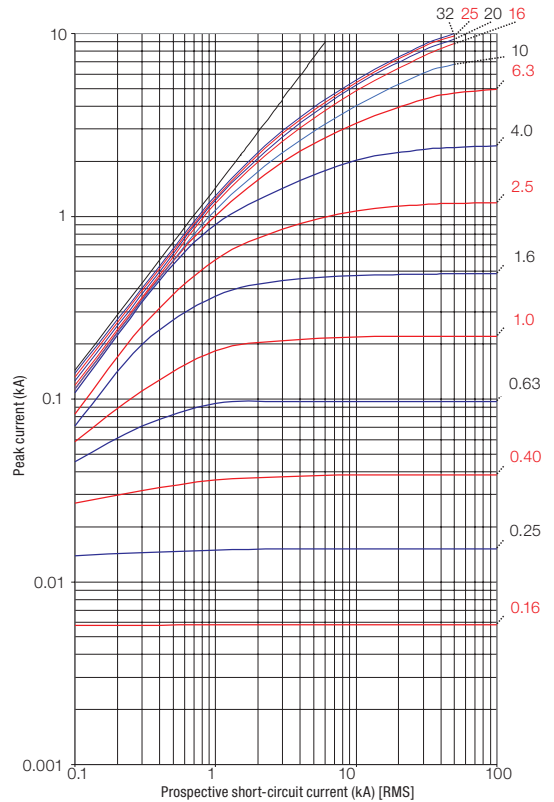

MPW - Diagrams and Typical Circuits

Diagrams

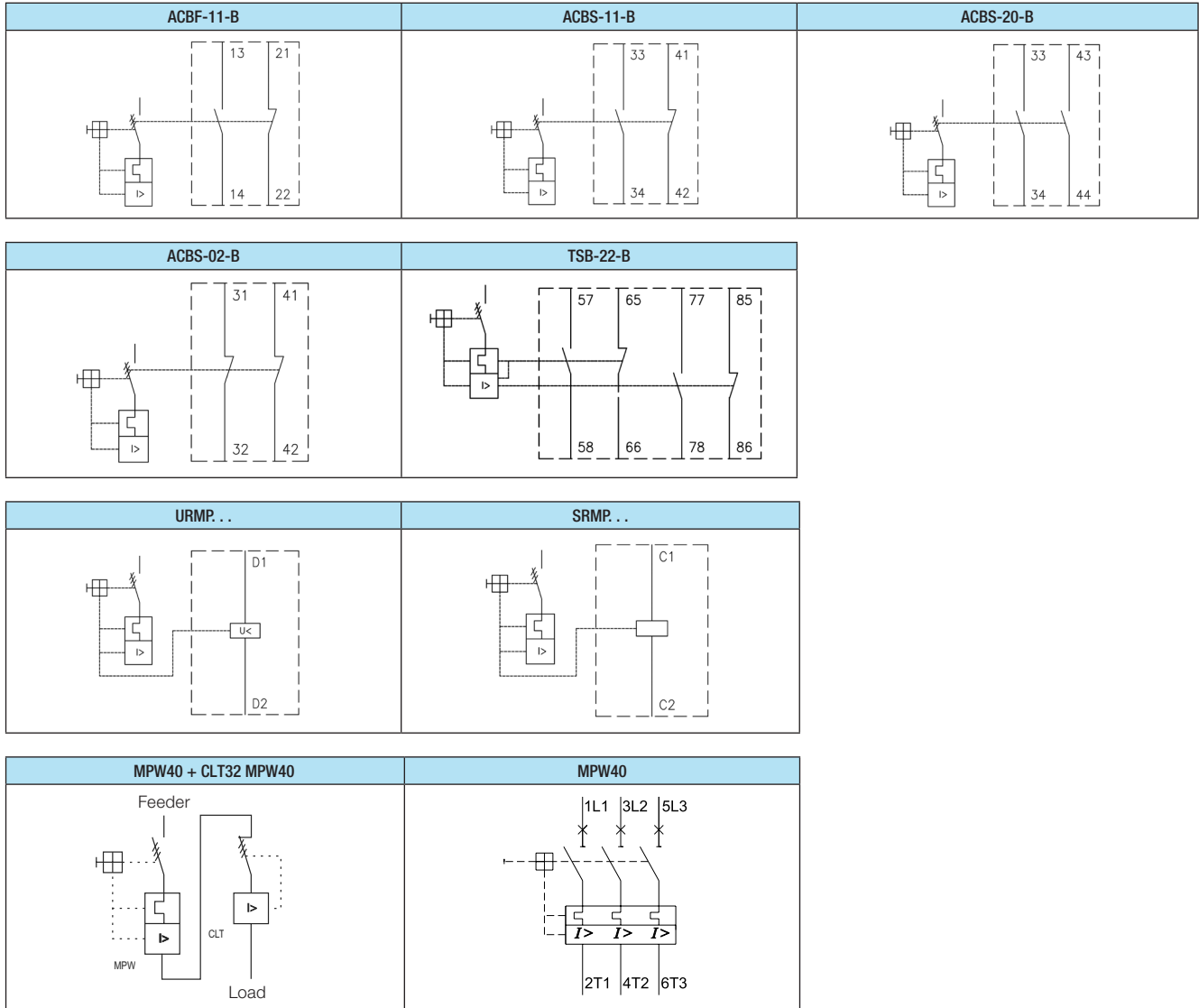

Typical Circuits

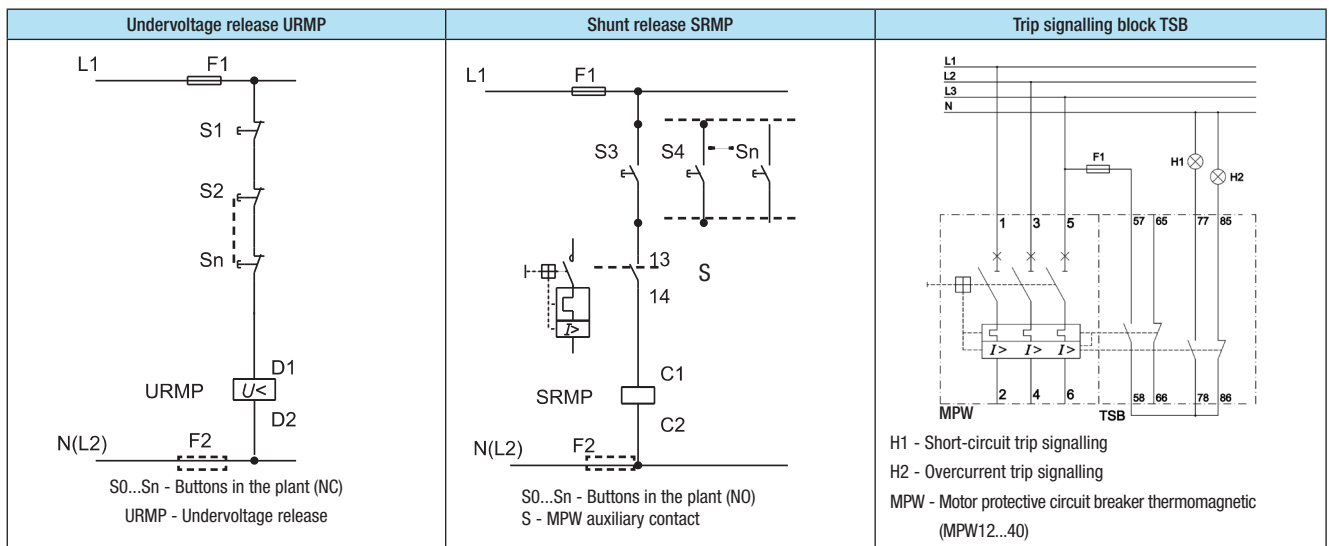

MPW - Diagrams and Typical Circuits

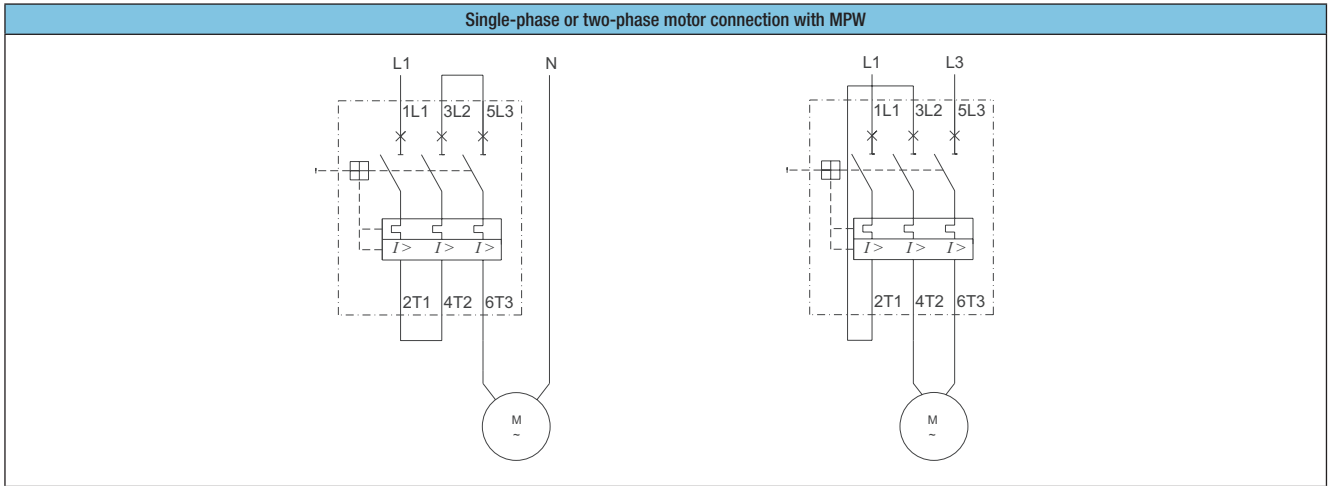

MPW - Dimensions (mm)

MPW18

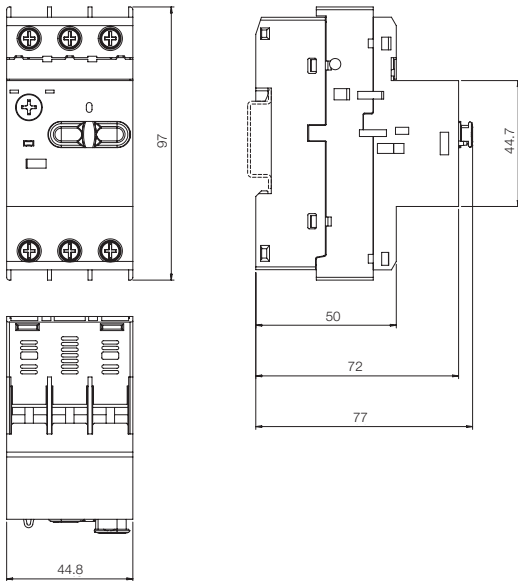

MPW18 + CWB9...18 / CWB25...38

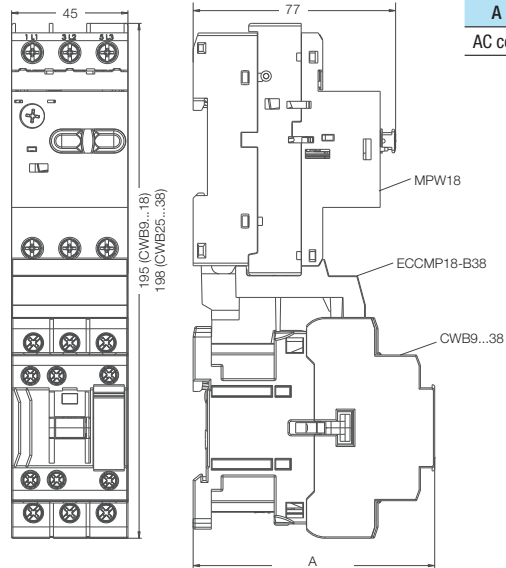

A	CWB9...18	CWB25...38
AC coil	89.5	93

MPW18 + Accessories

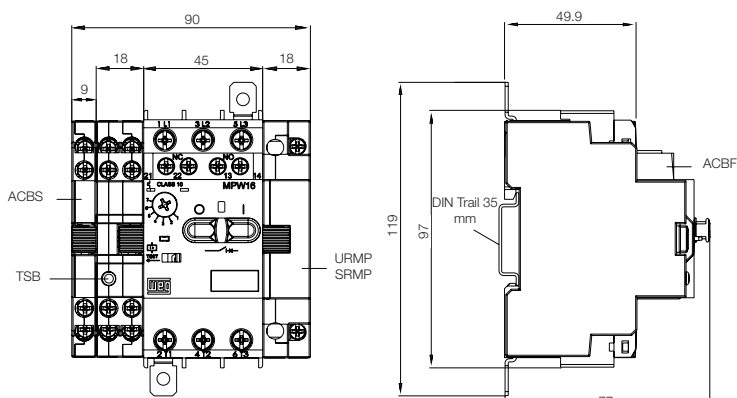

Mounting Position

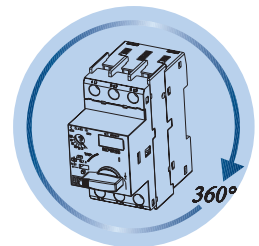

Low Voltage Industrial Controls

MPW - Dimensions (mm)



MPW40

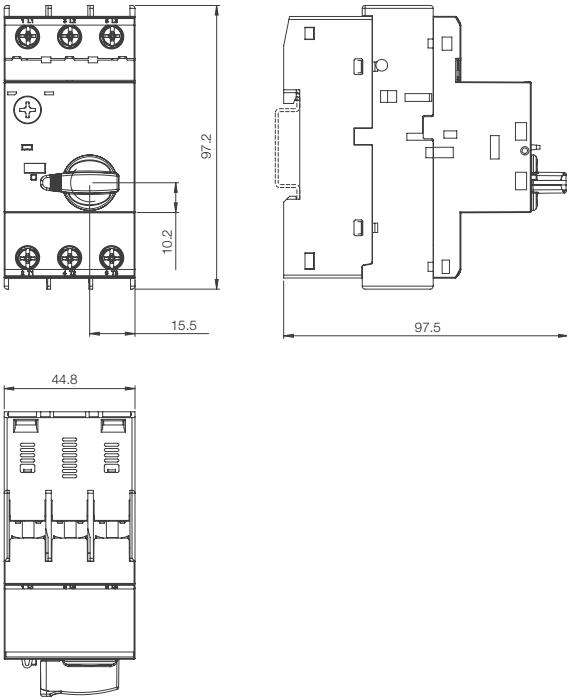

MPW40 + CWB9...18 / CWB25...38

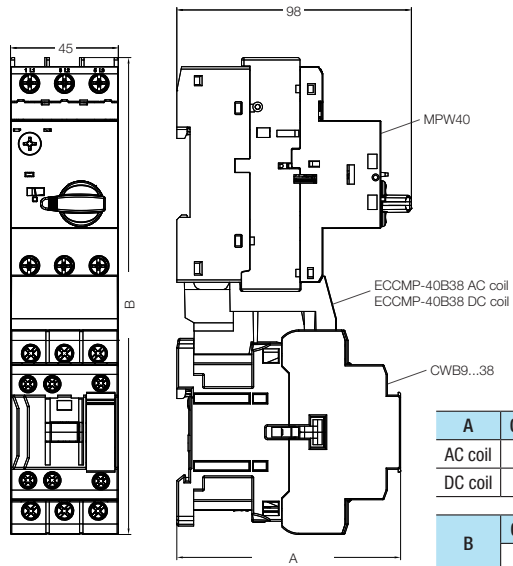

A	CWB9...18	CWB25...38
AC coil	89.5	93
DC coil	95.7	102.2

B	CWB9...18	CWB25...38
	196	199

MPW40 + Accessories

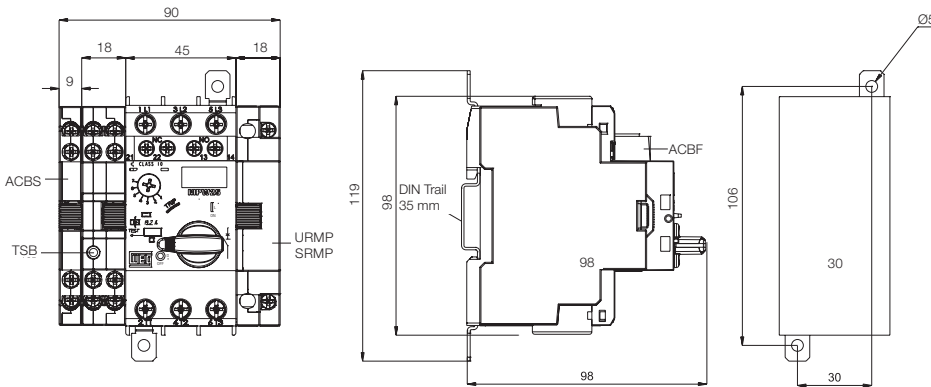

Mounting Position

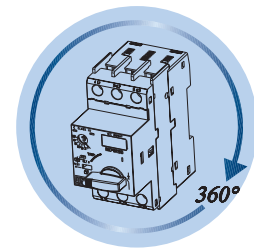

Current Limiter - CLT32 MPW40

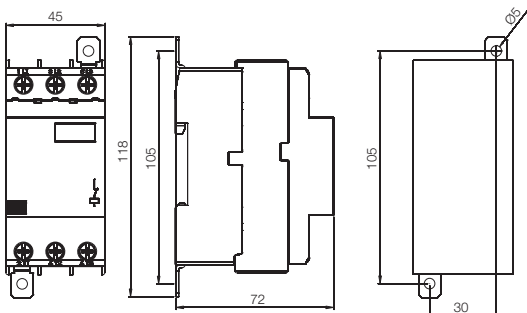

Insulated Enclosure - PE55GN(E)

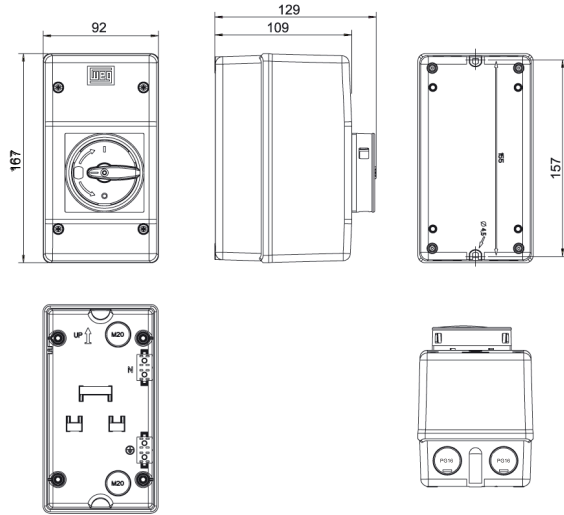

Insulated Enclosure - LPE55GN(E)

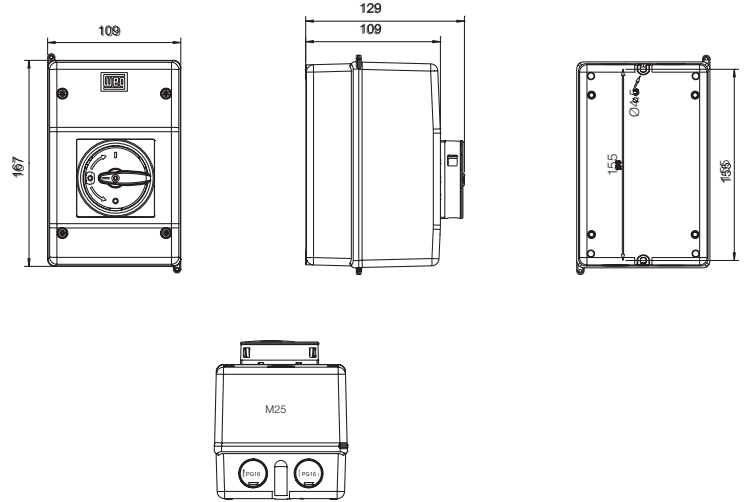

Manual Motor Protector Mounting Adapter Plates

MA45DOL

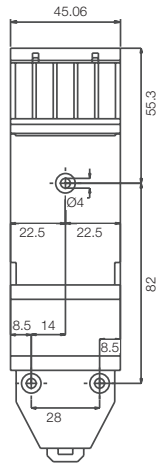

MA90RVS

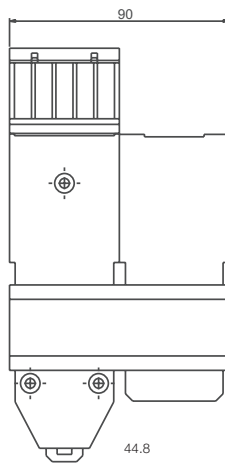

MA90SDS

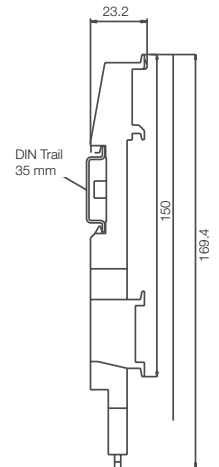
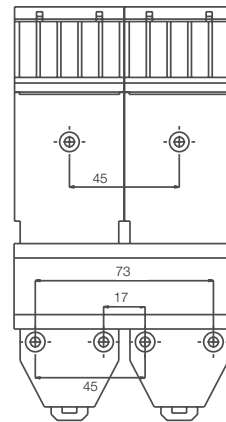

MPW - Dimensions (mm)

Accessories: BBS45, BBS54, FTBBS, CSD, LST25

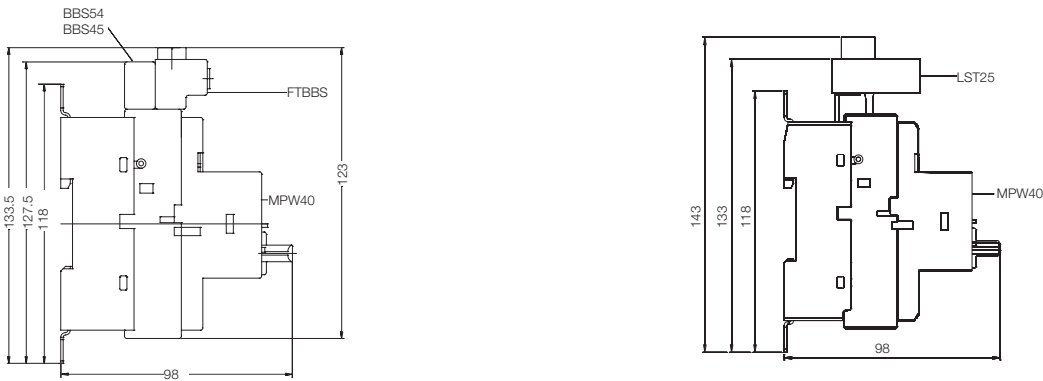
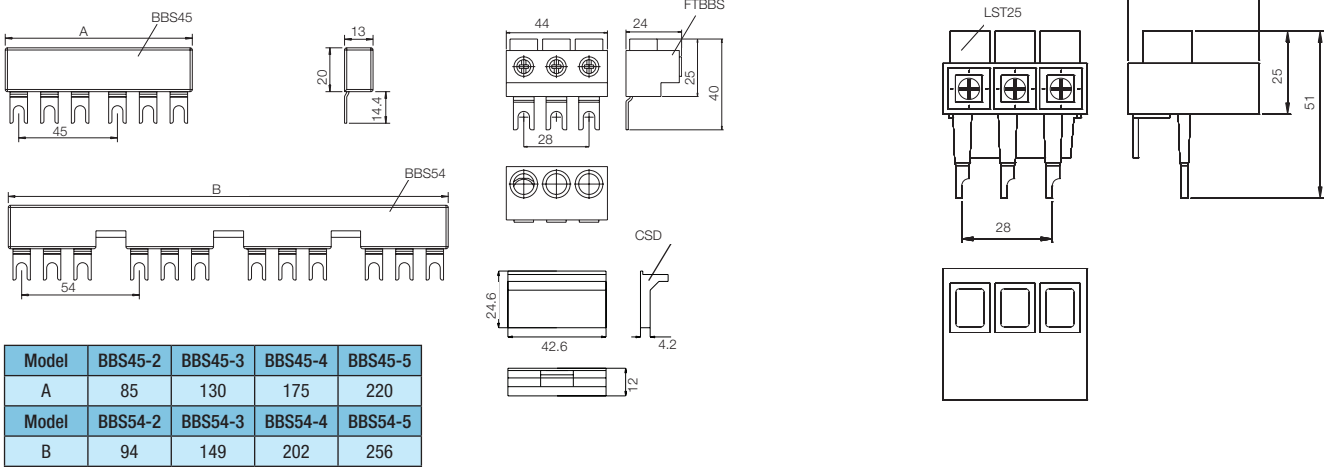

Rotary Handle - RMMP

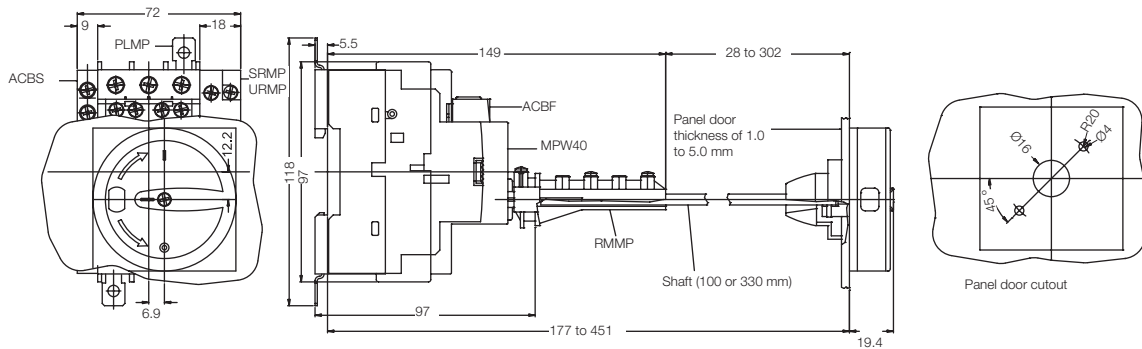

Rotary Handle - MRX

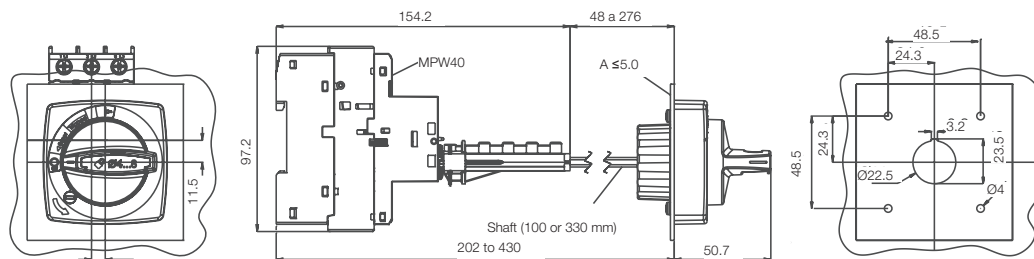





www.weg.net

WEG Electric Corp. offers the following products, and more! With a full range of IEC/NEMA Global Certifications and a full line of products, WEG can supply the right solution for your needs anywhere in the world. To learn more about WEG's products and solutions or to locate a Distributor near you, please call **1-800-ASK-4WEG** or visit **www.weg.net/us**.

**Low Voltage Motors,
Single and 3-Phase, 1/8 – 700HP**

- General Purpose Motors
- Explosion Proof Motors
- Crusher Duty Motors
- IEC Tru-Metric Motors
- Pump Motors including JP/JM
- P-Base Pump Motors
- Oil Well Pumping Motors
- Pool & Spa Motors
- Brake Motors
- Compressor Duty Motors
- Farm Duty Motors
- Poultry Fan Motors
- Auger Drive Motors
- IEEE 841 Motors
- Stainless Steel Wash Down Motors
- Saw Arbor Motors
- Cooling Tower Motors
- Commercial HVAC Motors
- Pad Mounted Motors
- Vector Duty Motors

Large Electric Motors

- Low Voltage 3-phase motors up to 2,500HP
- Motors up to 70,000HP and 13,200V
- Wound Rotor Systems (including starters) up to 70,000HP and 13,200V
- Synchronous Motors up to 70,000HP and 13,200V
- Explosion proof motors (Ex-d) up to 1,500kW and 11kV

Ex-n, Ex-e, Ex-p motors

Variable Frequency Drives

- Low Voltage 1/4 to 2500HP, 230V – 480V
- Medium Voltage 500-8000HP
- Multi-pump systems
- NEMA 4X
- Dynamic braking resistors
- Line and load reactors
- Plug and play technology
- Network communications: Profibus-DP, DeviceNet, Modbus-RTU
- PLC functions integrated
- Complete line of options and accessories

Soft Starters

- 3-1500HP
- Oriented start-up
- Built-in bypass contactor
- Universal source voltage (230-575V, 50/60Hz)
- Network communications: Profibus-DP, DeviceNet, Modbus-RTU
- Complete Line of options and accessories
- MV Soft-starter 3.3kV, 41.6kV: up to 3500HP, Withdrawable Power Stacks, & 8x PT100 Temperature monitoring

Controls

- Mini – Contactors
- IEC Contactors
- Thermal Overload Relays
- Manual Motor Protectors
- Molded Case Circuit Breakers
- Smart Relays
- Enclosed Starters: combination & non-

combination,

- Pushbuttons & Pilot Lights
- Timing & Motor Protection Relays
- Terminal Blocks

Custom Panels

- Custom configured to your specification.
- NEMA 1, 12, 3R, 4 and 4X cabinets
- Quick delivery of preconfigured drives and soft starters
- UL 508 certified
- Low Voltage (230-460)

Generators

- Brushless Synchronous Generators for diesel gen-sets up to 4,200kVA
- Hydro-generators up to 25,000kVA Turbo-generators up to 62,500kVA

Power Transformers

- Built and engineered in North America
- Voltages < 500kV
- Ratings 5-300MVA
- Station class, oil filled, round core, copper windings
- Special configurations and designs available!
- Ask your WEG Sales Representative for details.
- Designed, built, and engineered to ANSI standards.

Custom Solution Package Sales

- WEG can package any of its products for ease of sale! Enjoy a single point of contact for the entire package of products and assistance from quote through after-sales support. Ask your WEG Sales Representative for details.

Please contact your authorized distributor:

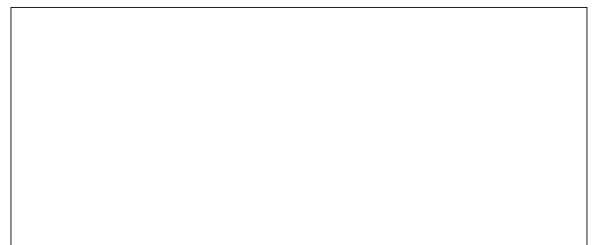

WEG Electric Corp.
6655 Sugarloaf Parkway
Duluth, GA 30097
Phone: 1-800-ASK-4WEG
www.weg.net

USA Industrial Controls (MMP.MPW)_0315