

**GENERAL DATASHEET
VARIABLE SPEED DRIVE**

SERIES F510		MODEL# F510-2075-C3-UE		
ISSUED 12/31/2019		ENCLOSURE/ FRAME Open Chassis (IP00) / F6		
INPUT AMPS ND (VT) 232		AC INPUT VOLTAGE 200-240	AC INPUT FREQUENCY 50/60	AC INPUT PHASE 3
OUTPUT HP ND (VT) 75	OUTPUT AMPS ND (VT) 200	AC OUTPUT VOLTAGE 0-240	AC OUTPUT FREQUENCY 0-400	AC OUTPUT PHASE 3

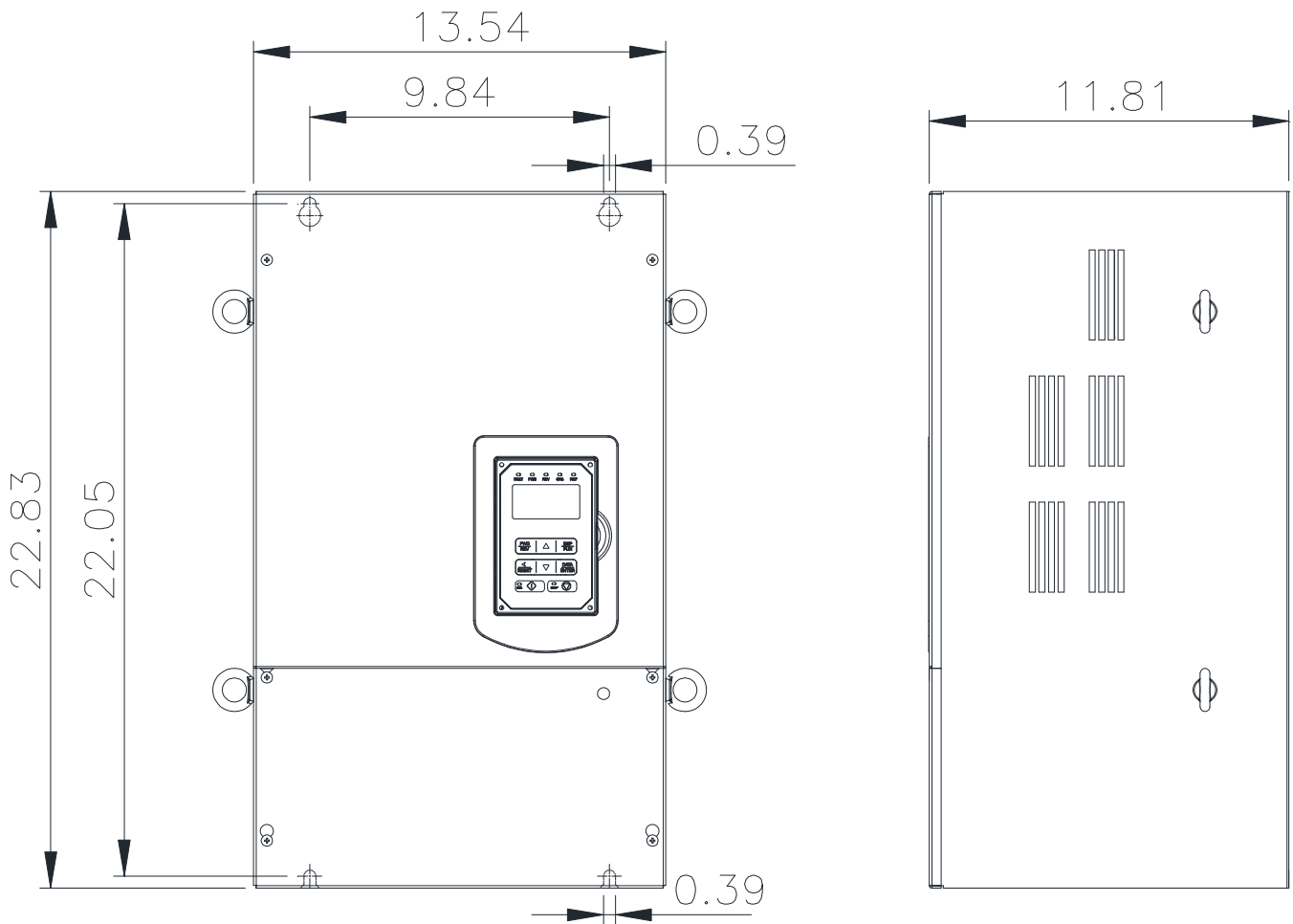

Approved By:	Brian Smith	Drawing No:	F510-230-075-F6	Revision: 1
--------------	-------------	-------------	-----------------	-------------