

DATE  
Sept. 25, 2006  
Cat. #: EPO306C

OUTLINE DIMENSIONS  
3-PHASE INDUCTION MOTOR

MOTOR TYPE:  
AEHH8N-CF  
FRAME NO. 326TC

Pole	HP	kW	Hz	VOLT	Syn. Speed r/min(rpm)
6	30	22.4	60	230/460	1200

Ins	Rating	Dimension in	Approx Weight	Bearings	
F	CONT.	inches	744 lbs	DE: 6312	NDE: 6212

Totally Enclosed Fan Cooled Type. Squirrel-cage Rotor.

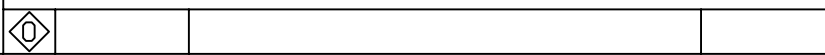
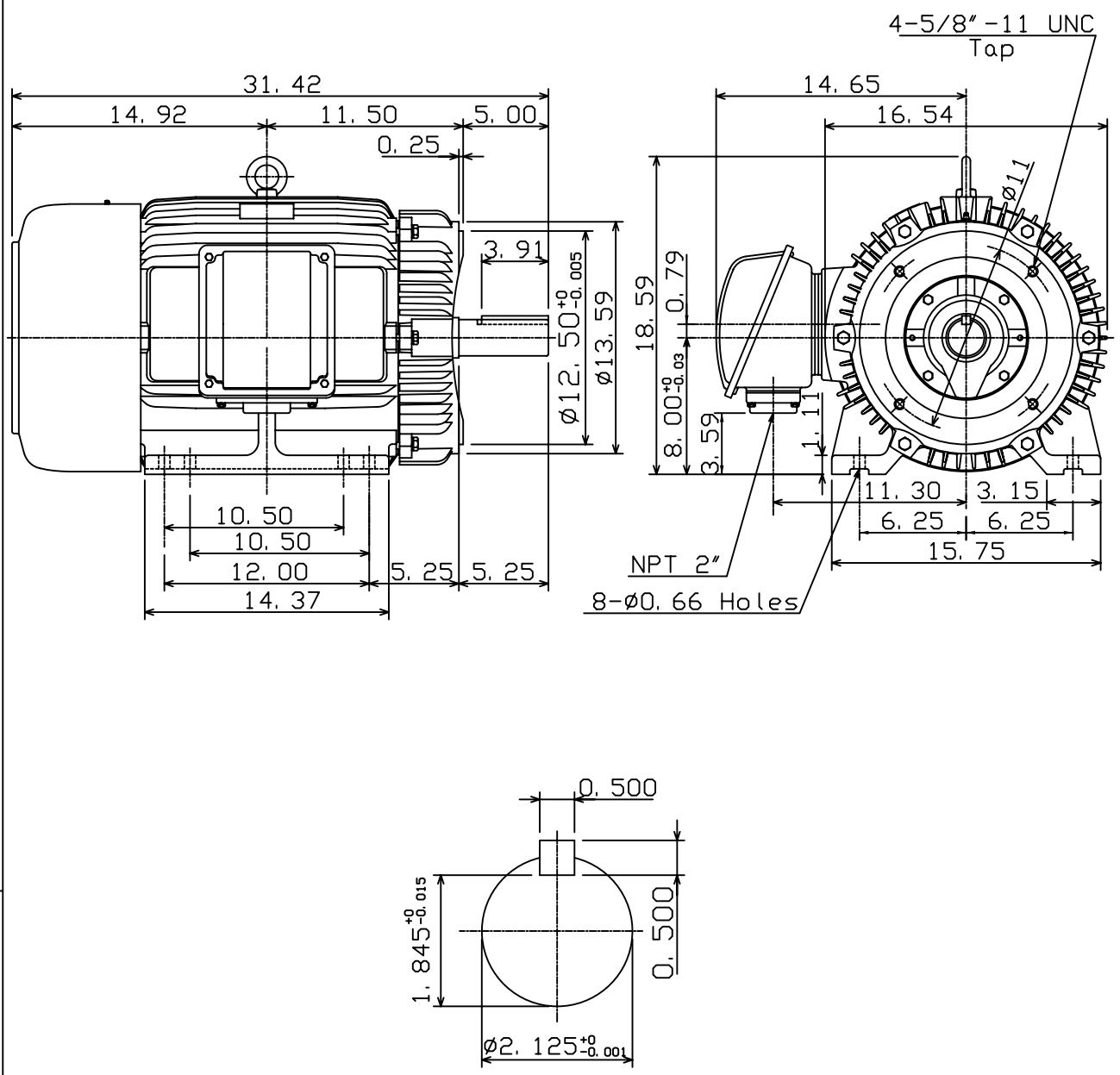

DWN.	K. L. KUO	01-10-05
CHKD.	C. H. KAO	01-28-05
APPD.	M. C. TSAI	01-28-05



DWG NO.  
31049J713130