

Datasheet - TR 236-02z



Position switch / 236 Thermoplastic enclosure - EN 50047 with Actuator / 236 Roller plunger
R

Preferred typ



- Thermoplastic enclosure
- Good resistance to oil and petroleum spirit
- Wide range of alternative actuators
- 30 mm x 58,5 mm x 30 mm
- 1 Cable entry M 20 x 1.5
- Double-insulated
- Mounting details to EN 50047
- Actuator heads can be repositioned by 4 x 90°

(Minor differences between the printed image and the original product may exist!)

Ordering details

Product type description	TR 236-02Z
Article number	101160532
EAN code	4030661190419
eCl@ss	27-27-26-01

Approval

Approval

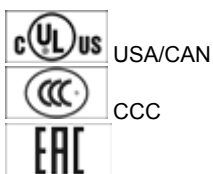

Classification

Standards	ISO 13849-1
B _{10d} Normally-closed contact (NC)	20.000.000
Mission time notice	20 Years
	$MTTF_d = \frac{B_{10d}}{0,1 \times n_{op}}$
	$n_{op} = \frac{d_{op} \times h_{op} \times 3600 \text{ s/h}}{t_{cycle}}$

Global Properties

Product name	T 236 Rollendruckbolzen R
Standards	IEC 60947-5-1, ISO 13849-1, BG-GS-ET-15
Compliance with the Directives (Y/N) 	Yes
Suitable for safety functions (Y/N)	Yes
Actuator type	C to EN 50047
Materials	
- Material of the housings	Plastic, glass-fibre reinforced thermoplastic, self-extinguishing
- Material of the contacts	Silver
Housing coating	None
Housing construction form	Norm construction design
Weight	65 g

Mechanical data

Design of actuating element	Roller plunger
Design of electrical connection	Screw connection
Cable section	
- Min. Cable section	1.5 mm ²
- Max. Cable section	2.5 mm ²
Mechanical life	20.000.000 operations
Switching frequency	max. 5000/h
notice	All indications about the cable section are including the conductor ferrules.
Actuating force	min. 9 N
Bounce duration	in accordance with actuating speed
Switchover time	in accordance with actuating speed
Positive break force	19 N
Actuating speed with actuating angle 30° to switch axis	
- Min. Actuating speed	120 mm/min
- Max. Actuating speed	1 m/s

Ambient conditions

Ambient temperature	
- Min. environmental temperature	-30 °C
- Max. environmental temperature	+80 °C
Protection class	IP67

Electrical data

Design of control element	Opener (NC)
Switching principle	Creep circuit element
- positive break NC contact 	
Number of auxiliary contacts	0 piece
Number of safety contacts	2 piece
Rated impulse withstand voltage U _{imp}	6 kV
Rated insulation voltage U _i	500 V
Thermal test current I _{the}	10 A
Utilisation category	AC-15: 230 V / 4 A, DC-13: 24 V / 1 A
Required rated short-circuit current	1000 A
Max. fuse rating	6 A gG D-fuse

Dimensions

Dimensions of the sensor

- Width of sensor 30 mm
- Height of sensor 84 mm
- Length of sensor 30 mm

Diagram

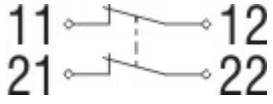

Note Diagram

- positive break NC contact
- active
- no active
- Normally-open contact
- Normally-closed contact

Switch travel diagram

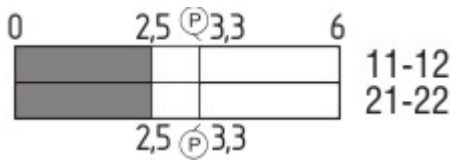

Notes Switch travel diagram

- Contact closed
- Contact open
- Setting range
- Break point
- Positive opening sequence/- angle
- VS** adjustable range of NO contact
- VÖ** adjustable range of NC contact
- N** after travel

Ordering suffix

The applicable ordering suffix is added at the end of the part number of the safety switch.

Order example: TR 236-02z-1637

--1637 0,3 µm gold-plated contacts
-- ID IDC method of termination
--NPT Cable entry NPT 1/2"
--1297 Enclosure with transverse slotted holes

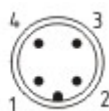
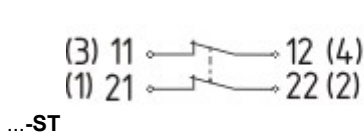

....-ST

- M12 connector with A-coding
- Rated impulse withstand voltage U_{imp} : 0,8 kV
- Rated insulation voltage U_i : 50 V
- Operating current I_e : AC-15: 50 V / 4 A

Caution! The versions with connector may only be used in PELV circuits to EN 60204-1.

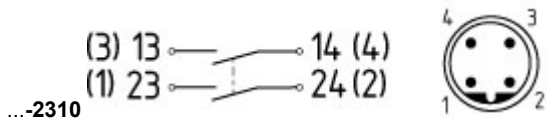

M12 connector with B-coding

Rated impulse withstand voltage U_{imp} : 0,8 kV

Rated insulation voltage U_i : 50 V

Operating current I_e : AC-15 50 V / 4 A

Caution! The versions with connector may only be used in PELV circuits to EN 60204-1.

Ordering code

(1)(2) 2(3)6-(4)Z(5)-(6)-(7)-(8)-(9)

(1)

Z Snap action

T Slow action

(2)

S Plunger S

R Roller plunger R

4S Plunger 4S

4R Roller plunger 4R

1R Offset roller lever 1R

K Offset roller lever K

3K Angle roller lever 3K

4K Angle roller lever 4K

K4 Angle roller lever K4

1H Roller lever 1H

7H Roller lever 7H

10H Rod lever 10H

12H Roller lever 12H

14H Roller lever 14H

AF Spring rod lever AF

(3)

3 slim design

5 large design

(4)

02 2 Opener (NC)

11 1 Normally open contact (NO) / 1 Opener (NC)

20 2 Normally open contact (NO), (Switch with 2 NO contacts are not for security tasks)

(5)

H Slow action with staggered contacts

UE Slow action with overlapping contacts

(6)

without Cable entry M20

ID IDC method of termination

NPT cable entry NPT 1/2"

ST M12 connector with A-coding

ST-2310 M12 connector with B-coding

(7)

1297 Enclosure with transverse slotted holes

(8)

2138	Roller lever 7H for Position switches with safety function
(9)	
1637	gold-plated contacts

Documents

Operating instructions and Declaration of conformity (da) 304 kB, 21.08.2013

Code: mrl_ZT235_236_da

Operating instructions and Declaration of conformity (de) 302 kB, 09.03.2016

Code: mrl_ZT235_236_de

Operating instructions and Declaration of conformity (en) 334 kB, 09.03.2016

Code: mrl_ZT235_236_en

Operating instructions and Declaration of conformity (pl) 358 kB, 16.04.2014

Code: mrl_ZT235_236_pl

Operating instructions and Declaration of conformity (pt) 323 kB, 15.07.2014

Code: mrl_ZT235_236_pt

Operating instructions and Declaration of conformity (es) 318 kB, 13.04.2016

Code: mrl_ZT235_236_es

Operating instructions and Declaration of conformity (it) 300 kB, 16.04.2014

Code: mrl_ZT235_236_it

Operating instructions and Declaration of conformity (fr) 321 kB, 16.04.2014

Code: mrl_ZT235_236_fr

Operating instructions and Declaration of conformity (jp) 574 kB, 16.04.2014

Code: mrl_ZT235_236_jp

Operating instructions and Declaration of conformity (nl) 318 kB, 16.04.2014

Code: mrl_ZT235_236_nl

CCC certification (cn) 782 kB, 28.06.2016

Code: q_235p02

CCC certification (en) 803 kB, 28.06.2016

Code: q_235p01

EAC certification (ru) 844 kB, 05.10.2015

Code: q_6037p17_ru

Images

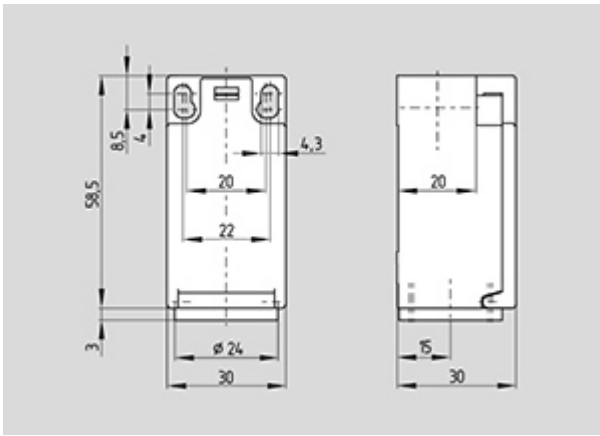

Dimensional drawing (basic component)

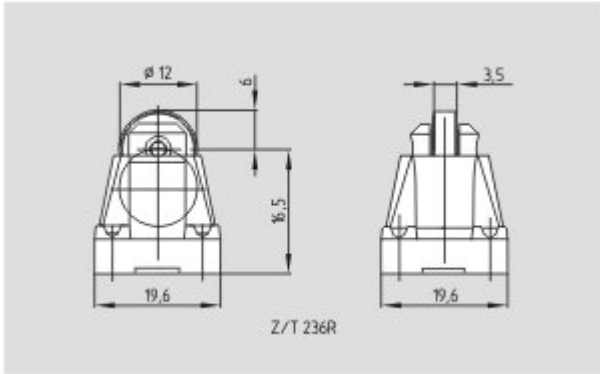

Dimensional drawing (actuator)

K.A. Schmersal GmbH & Co. KG, Mödinghofe 30, D-42279 Wuppertal

The data and values have been checked thoroughly. Technical modifications and errors excepted.

Generiert am 19.07.2016 - 21:36:12h Kasbase 3.2.4.F.64I