



EN Operating instructions.pages 1 to 6
Original

Content

1 About this document

1.1 Function 1

1.2 Target group: authorised qualified personnel. 1

1.3 Explanation of the symbols used 1

1.4 Appropriate use 1

1.5 General safety instructions 1

1.6 Warning about misuse 2

1.7 Exclusion of liability 2

2 Product description

2.1 Ordering code 2

2.2 Special versions. 2

2.3 Purpose 2

2.4 Technical data 2

2.5 Safety classification 3

3 Mounting

3.1 General mounting instructions 3

3.2 Dimensions 3

4 Electrical connection

4.1 General information for electrical connection. 3

5 Operating principle and settings

5.1 LED functions. 3

5.2 Description of the terminals 3

5.3 Notes 3

6 Set-up and maintenance

6.1 Functional testing. 4

6.2 Maintenance 4

7 Disassembly and disposal

7.1 Disassembly. 4

7.2 Disposal 4

8 Appendix

8.1 Wiring examples 4

8.2 Start configuration 4

8.3 Sensor configuration 4

8.4 Actuator configuration 5

9 EU Declaration of conformity

1. About this document

1.1 Function

This operating instructions manual provides all the information you need for the mounting, set-up and commissioning to ensure the safe operation and disassembly of the safety-monitoring module. The operating instructions must be available in a legible condition and a complete version in the vicinity of the device.

1.2 Target group: authorised qualified personnel

All operations described in this operating instructions manual must be carried out by trained specialist personnel, authorised by the plant operator only.

Please make sure that you have read and understood these operating instructions and that you know all applicable legislations regarding occupational safety and accident prevention prior to installation and putting the component into operation.

The machine builder must carefully select the harmonised standards to be complied with as well as other technical specifications for the selection, mounting and integration of the components.

1.3 Explanation of the symbols used



Information, hint, note:

This symbol is used for identifying useful additional information.



Caution: Failure to comply with this warning notice could lead to failures or malfunctions.

Warning: Failure to comply with this warning notice could lead to physical injury and/or damage to the machine.

1.4 Appropriate use

The products described in these operating instructions are developed to execute safety-related functions as part of an entire plant or machine. It is the responsibility of the manufacturer of a machine or plant to ensure the correct functionality of the entire machine or plant.

The safety-monitoring module must be exclusively used in accordance with the versions listed below or for the applications authorised by the manufacturer. Detailed information regarding the range of applications can be found in the chapter "Product description".

1.5 General safety instructions

The user must observe the safety instructions in this operating instructions manual, the country specific installation standards as well as all prevailing safety regulations and accident prevention rules.



Further technical information can be found in the Schmersal catalogues or in the online catalogue on the Internet: www.schmersal.net.

The information contained in this operating instructions manual is provided without liability and is subject to technical modifications.

There are no residual risks, provided that the safety instructions as well as the instructions regarding mounting, commissioning, operation and maintenance are observed.

1.6 Warning about misuse



In case of inadequate or improper use or manipulations of the safety-monitoring module, personal hazards or damage to machinery or plant components cannot be excluded. The relevant requirements of the standards ISO 14119 and ISO 13850 must be observed.

1.7 Exclusion of liability

We shall accept no liability for damages and malfunctions resulting from defective mounting or failure to comply with this operating instructions manual. The manufacturer shall accept no liability for damages resulting from the use of unauthorised spare parts or accessories.

For safety reasons, invasive work on the device as well as arbitrary repairs, conversions and modifications to the device are strictly forbidden, the manufacturer shall accept no liability for damages resulting from such invasive work, arbitrary repairs, conversions and/or modifications to the device.

The safety-monitoring module must only be used when the enclosure is closed, i.e. with the front cover fitted.

2. Product description

2.1 Ordering code

This operating instructions manual applies to the following types:

SRB 301MA^①

No.	Option	Description
①	/CC	Screw terminals 0.25...1.5 mm ² plug-in cage clamps 0.25 ... 1.5 mm ²



Only if the information described in this operating instructions manual are realised correctly, the safety function and therefore the compliance with the Machinery Directive is maintained.

2.2 Special versions

For special versions, which are not listed in the order code below 2.1, these specifications apply accordingly, provided that they correspond to the standard version.

2.3 Purpose

The safety-monitoring modules for integration in safety circuits are designed for fitting in control cabinets. They are used for the safe evaluation of the signals of positive break position switches or magnetic safety sensors for safety functions on sliding, hinged and removable safety guards as well as emergency stop control devices and AOPDs.

The safety function is defined as the opening of the enabling circuits 13-14, 23-24 and 33-34 when the inputs S11-S12 and/or S21-S22 are opened.

The safety-relevant current paths with the outputs contacts 13-14, 23-24 and 33-34 meet the following requirements under observation of a PFH value assessment (also refer to chapter 2.5 "Safety classification"):

- Control category 4 - PL e to ISO 13849-1
- SIL 3 to IEC 61508-2
- SILCL 3 to IEC 62061

To determine the Performance Level (PL) to ISO 13849-1 of the entire safety function (e.g. sensor, logic, actuator), an assessment of all relevant components is required.



The entire concept of the control system, in which the safety component is integrated, must be validated to the relevant standards.

2.4 Technical data

General data:

Standards: IEC 60204-1, IEC 60947-5-1, ISO 13849-1, IEC 61508

Climate resistance: EN 60068-2-78

Mounting: snaps onto standard rail to EN 60715

Terminal designations: IEC 60947-1

Material of the housings: Plastic, glass-fibre reinforced thermoplastic, ventilated

Material of the contacts: AgSnO, self-cleaning, positive drive

Weight: 230 g

Start conditions: start button (monitored)

Feedback circuit (Y/N): yes

Pull-in delay with reset button: typ. 15 ms / max. 20 ms

Drop-out delay in case of emergency stop: typ. 10 ms / max. 15 ms

Drop-out delay on "supply failure": typ. 80 ms

Bridging in case of voltage drops: typ. 80 ms

Mechanical data:

Connection type: refer to 2.1 Ordering code

Cable section: refer to 2.1 Ordering code

Connecting cable: rigid or flexible

Tightening torque for the terminals: 0.6 Nm

With removable terminals (Y/N): refer to 2.1 Ordering code

Mechanical life: 10 million operations

Electrical life: Derating curve available on request

Resistance to shock: 30 g / 11 ms

Resistance to vibration in accordance with EN 60068-2-6: 10 to 150 Hz,

Amplitude 0.35 mm

Ambient temperature: -25 °C ... +60 °C

Storage and transport temperature: -40 °C ... +85 °C

Protection class: Enclosure: IP40

Terminals: IP20

Clearance: IP54

Air clearances and creepage distances

to IEC 60664-1: 4 kV/2 (basic insulation)

EMC rating: to EMC Directive

Electrical data:

Contact resistance in new state: max. 100 mΩ

Power consumption: max. 1.8 W / 4.4 VA

Rated operating voltage U_e : 24 VDC -15% / +20%,

residual ripple max. 10%

24 VAC -15% / +10%

Frequency range: 50 / 60 Hz

Fuse rating for the operating voltage: Internal electronic trip, tripping

current > 500 mA, reset after approx. 1 sec.

Monitored inputs:

Cross-wire detection (Y/N): Yes

Wire breakage detection (Y/N): Yes

Earth leakage detection (Y/N): Yes

Number of NO contacts: 0

Number of NC contacts: 2

Cable length: 1,500 m with 1.5 mm²

2,500 m with 2.5 mm²

Conduction resistance: max. 40 Ω

Outputs:

Number of safety contacts: 3

Number of auxiliary contacts: 1

Number of signalling outputs: 0

Max. switching capacity of the safety contacts:

- 13-14, 23-24, 33-34: max. 250 V, 8 A ohmic (inductive

in case of suitable protective wiring),

min. 10 V / 10 mA, residual current

at ambient temperature up to:

45 °C: 24 A, 55 °C: 18 A, 60 °C: 12 A

Switching capacity of the auxiliary contacts: 41-42: 24 VDC / 2 A

Fuse rating of the safety contacts: external ($I_k = 1000 A$)

to IEC 60947-5-1

Safety fuse 10 A quick blow, 8 A slow blow

Fuse rating for the auxiliary contacts:	external ($I_k = 1000 \text{ A}$) to IEC 60947-5-1
	Safety fuse 2.5 A quick blow, 2 A slow blow
Utilisation category to IEC 60947-5-1:	AC-15: 230 VAC / 6 A, DC-13: 24 VDC / 6 A
Dimensions H x W x D:	SRB 301MA: 100 x 22.5 x 121 mm SRB 301MA/CC: 130 x 22.5 x 121 mm

The data specified in this manual are applicable when the component is operated with rated operating voltage $U_e \pm 0\%$.



Use copper conductors only.
Use 60°C/75°C conductors.
Use No. 28-12 AWG wire size only.
Tightening torque: 5 lb in.
Use 60/75°C wire only.

2.5 Safety classification

Standards:	ISO 13849-1, IEC 61508, IEC 60947-5-1
PL:	e
Control Category:	4
DC:	99% (high)
CCF:	> 65 points
PFH value:	$\leq 2.00 \times 10^{-8}/\text{h}$
SIL:	up to 3
Mission time:	20 years

The PFH value of $2.00 \times 10^{-8}/\text{h}$ applies to the combinations of contact load (current through enabling contacts) and number of switching cycles (n_{oply}) mentioned in the table below. At 365 operating days per year and a 24-hours operation, this results in the below-mentioned switching cycle times (t_{cycle}) for the relay contacts. Diverging applications upon request.

Contact load	n_{oply}	t_{cycle}
20 %	525,600	1.0 min
40 %	210,240	2.5 min
60 %	75,087	7.0 min
80 %	30,918	17.0 min
100 %	12,223	43.0 min

3. Mounting

3.1 General mounting instructions

Mounting: snaps onto standard DIN rails to EN 60715.

Snap the bottom of the enclosure slightly tilted forwards in the standard rail and push up until it latches in position.



To avoid EMC disturbances, the physical ambient and operational conditions at the place where the product is installed, must meet the provisions laid down in the paragraph "Electromagnetic Compatibility (EMC)" of IEC 60204-1.

3.2 Dimensions

All measurements in mm.

Device dimensions (H/W/D):
SRB 301MA: 100 x 22.5 x 121 mm
SRB 301MA/CC: 130 x 22.5 x 121 mm

4. Electrical connection

4.1 General information for electrical connection



As far as the electrical safety is concerned, the protection against unintentional contact of the connected and therefore electrically interconnected apparatus and the insulation of the feed cables must be designed for the highest voltage, which can occur in the device.



The electrical connection may only be carried out by authorised personnel in a de-energised condition.

Wiring examples: see appendix.

5. Operating principle and settings

5.1 LED functions

- K1: Status channel 1
- K2: Status channel 2
- U_B : Status operating voltage (LED is on, when the operating voltage on the terminals A1-A2 is ON)
- U_i : Status internal operating voltage (LED is on, when the operating voltage on the terminals A1-A2 is ON and the fuse has not been triggered).

5.2 Description of the terminals

Voltages:	A1	+24 VDC/24 VAC
	A2	0 VDC/24 VAC
Inputs:	S11 - S12	Input channel 1 (+)
	S12 - S22	Input channel 2 (+)
	S21 - S22	Input channel 2 (-) (with cross-wire short detection)
Outputs:	13 - 14	First safety enabling circuit
	23 - 24	Second safety enabling circuit
	33 - 34	Third safety enabling circuit
Start:	X1 - X2	Feedback circuit and external reset
	41 - 42	Auxiliary NC contact as signalling contact

5.3 Notes



Signalling outputs must not be used in safety circuits.

Opening the front cover (see Fig. 2)

- To open the front cover, insert a slotted screwdriver in the top and bottom cover notch and gently lift it.
- When the front cover is open, the electrostatic discharge requirements must be respected and observed.
- After setting, the front cover must be fitted back in position.



Only touch the components after electrical discharge!

Setting the switch (see Fig. 3)

- The cross-wire short monitoring function (factory setting) is programmed by means of the switch underneath the front cover of the safety-monitoring module.
- The switch must only be operated in de-energised condition by means of a finger or an insulated blunt tool.
- Pos. nQS (top): Not cross-wire short proof, suitable for 1-channel applications with outputs connected to potential in the control circuits.
- Pos. QS (bottom), Cross-wire short proof: suitable for 2-channel applications without outputs connected to potential in the control circuits.

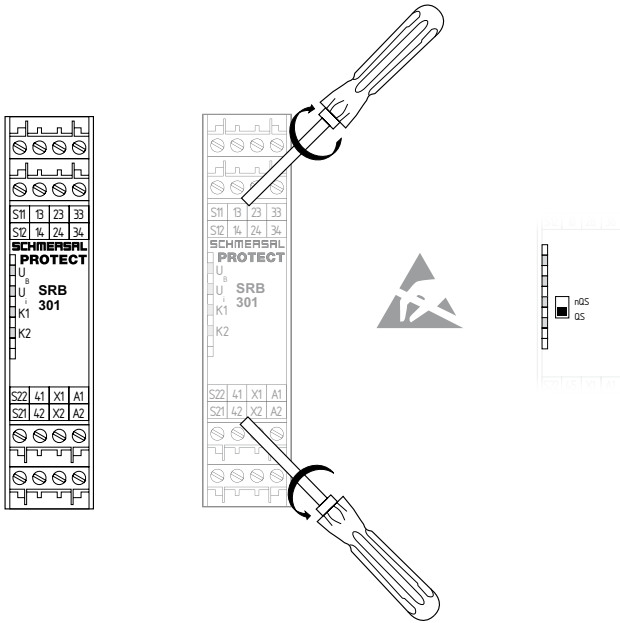

Fig. 1

Fig. 2

Fig. 3

6. Set-up and maintenance

6.1 Functional testing

The safety function of the safety-monitoring module must be tested. The following conditions must be previously checked and met:

1. Correct fixing
2. Check the integrity of the cable entry and connections
3. Check the safety-monitoring module's enclosure for damage.
4. Check the electrical function of the connected sensors and their influence on the safety-monitoring module and the downstream actuators

6.2 Maintenance

A regular visual inspection and functional test, including the following steps, is recommended:

1. Check the correct fixing of the safety-monitoring module
2. Check the cable for damages
3. Check electrical function



If a manual functional check is necessary to detect a possible accumulation of faults, then this must take place during the intervals noted as follows:

- at least every month for PL e with category 3 or category 4 (according to ISO 13849-1) or SIL 3 with HFT (hardware fault tolerance) = 1 (according to IEC 62061),
- at least every 12 months for PL d with category 3 (according to ISO 13849-1) or SIL 2 with HFT (hardware fault tolerance) = 1 (according to IEC 62061).

Damaged or defective components must be replaced.

7. Disassembly and disposal

7.1 Disassembly

The safety-monitoring module must be disassembled in a de-energised condition only.

Push up the bottom of the enclosure and hang out slightly tilted forwards.

7.2 Disposal

The safety-monitoring module must be disposed of in an appropriate manner in accordance with the national prescriptions and legislations.

8. Appendix

8.1 Wiring examples

Dual-channel control, shown for a guard door monitor with two position switches where one has a positive break contact; with external reset button (R) (Fig. 4)

- Relay outputs: Suitable for 2-channel control, for increase in capacity or number of contacts by means of contactors or relays with positive-guided contacts.
- The control system recognises wire-breakage, earth faults and cross-wire shorts in the monitoring circuit.
- (R) = Feedback circuit

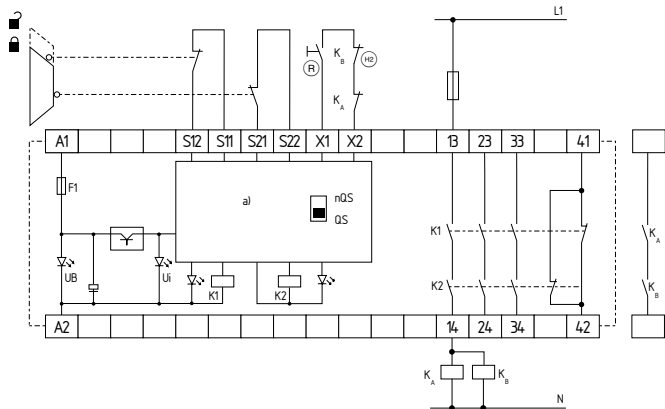

Fig. 4

a) Logic

8.2 Start configuration

External reset button (with edge detection) (see Fig. 5)

- The external reset button is integrated as shown.
- The safety-monitoring module is activated by the reset (after release) of the reset button (= detection of the trailing edge). Faults in the reset button, e.g. welded contacts or manipulations which could lead to an inadvertent restart, are detected in this configuration and will result in an inhibition of the operation.

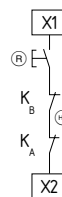

Fig. 5

8.3 Sensor configuration

Single-channel emergency stop circuit with command devices to ISO 13850 and IEC 60947-5-5 (Fig. 6)

- Wire breakage and earth leakage in the control circuits are detected.
- Category 1 – PL c to ISO 13849-1 possible.

Dual-channel emergency stop circuit with command devices to ISO 13850 and IEC 60947-5-5 (Fig. 7)

- Wire breakage and earth leakage in the control circuits are detected.
- Cross-wire shorts between the control circuits are not detected.
- Control category 4 – PL e to ISO 13849-1 possible (with protective wiring)

Dual-channel emergency stop circuit with command devices to ISO 13850 and IEC 60947-5-5 (Fig. 8)

- Wire breakage and earth leakage in the control circuits are detected.

- Cross-wire shorts between the control circuits are detected.
- Category 4 – PL e to ISO 13849-1 possible.

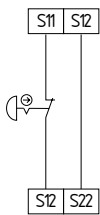

Fig. 6

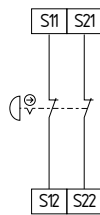

Fig. 7

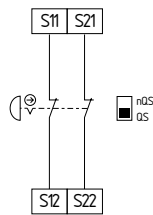

Fig. 8

Single-channel guard door monitoring circuit with interlocking devices to ISO 14119 (Fig. 9)

- At least one contact with positive break required.
- Wire breakage and earth leakage in the control circuits are detected.
- Category 1 – PL c to ISO 13849-1 possible.

Dual-channel guard door monitoring circuit with interlocking device to ISO 14119 (Fig. 10)

- At least one contact with positive break required.
- Wire breakage and earth leakage in the control circuits are detected.
- Cross-wire shorts between the monitoring circuits **are not detected**.
- Control category 4 – PL e to ISO 13849-1 possible (with protective wiring)

Dual-channel guard door monitoring circuit with interlocking device to ISO 14119 (Fig. 11)

- At least one contact with positive break required.
- Wire breakage and earth leakage in the control circuits are detected.
- Cross-wire shorts between the guard monitoring circuits are detected.
- Category 4 – PL e to ISO 13849-1 possible.

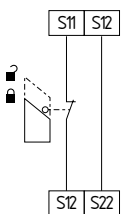

Fig. 9

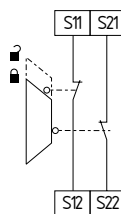

Fig. 10

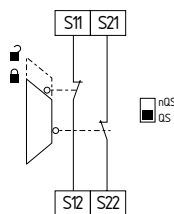

Fig. 11

Dual-channel control of a safety-related electronic (microprocessor-based) safety guard with p-type transistor outputs e.g. AOPDs to IEC 61496 (see Fig. 12)

- Wire breakage and earth leakage in the control circuits are detected.
- The safety-monitoring module therefore is not equipped with a cross-wire short detection here. The safety-monitoring module therefore is not equipped with a cross-wire short detection here.
- Category 3 – PL e to ISO 13849-1 possible.
- If cross-wire shorts in the control circuits are detected by the safety guard:
Control category 4 – PL e to ISO 13849-1 possible.

Dual-channel control of magnetic safety switches according to IEC 60947-5-3 (see Fig. 13)

- The control system recognises wire breakage and earth faults in the control circuit.
- Cross-wire shorts between the control circuits are not detected.
- Category 3 – PL e to ISO 13849-1 possible.

Dual-channel control of magnetic safety switches according to IEC 60947-5-3 (see Fig. 14)

- The control system recognises wire breakage and earth faults in the control circuit.
- Cross-wire shorts between the control circuits are detected.
- Category 4 – PL e to ISO 13849-1 possible.



The connection of magnetic safety switches to the SRB 301MA safety-monitoring module is only admitted when the requirements of the standard IEC 60947-5-3 are observed.

As the technical data are regarded, the following minimum requirements must be met:

- Switching capacity: min. 240 mW
- Switching voltage: min. 24 VDC
- switching current: min. 10 mA



For example, the following safety sensors meet the requirements:

- BNS 33-02Z-2187, BNS 33-02ZG-2187
- BNS 260-02Z, BNS 260-02ZG
- BNS 260-02-01Z, BNS 260-02-01ZG



When sensors with LED are wired in the control circuit (protective circuit), the following rated operating voltage must be observed and respected:

- 24 VDC with a max. tolerance of $-5\%/+20\%$
- 24 VAC with a max. tolerance of $-5\%/+10\%$

Otherwise availability problems could occur, especially in series-wired sensors, where a voltage drop in the control circuit is triggered by LEDs for instance.

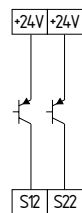

Fig. 12

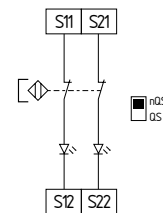

Fig. 13

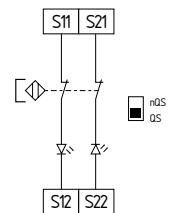

Fig. 14

8.4 Actuator configuration

Single-channel control with feedback circuit (Fig. 15)

- Suitable for increase in capacity or number of contacts by means of contactors or relays with positive-guided contacts.
- (R) Reset button (with edge detection)
- (HE) = feedback circuit: If the feedback circuit is not required, establish a bridge.

Dual-channel control with feedback circuit (see Fig. 16)

- Suitable for increase in capacity or number of contacts by means of contactors or relays with positive-guided contacts.
- (R) Reset button (with edge detection)
- (HE) = feedback circuit: If the feedback circuit is not required, establish a bridge.

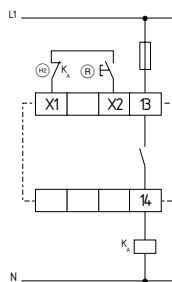

Fig. 15

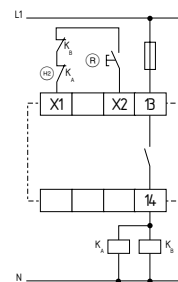

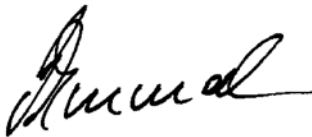

Fig. 16

9. EU Declaration of conformity

EU Declaration of conformity		
Original	K.A. Schmersal GmbH & Co. KG Möddinghofe 30 42279 Wuppertal Germany Internet: www.schmersal.com	
We hereby certify that the hereafter described components both in their basic design and construction conform to the applicable European Directives.		
Name of the component:	SRB301MA, SRB301MA/CC	
Description of the component:	Safety-monitoring module for emergency stop circuits, guard door monitoring, magnetic safety switches and AOPDs	
Relevant Directives:	Machinery Directive	2006/42/EC
	EMC-Directive	2014/30/EU
	RoHS-Directive	2011/65/EU
Applied standards:	EN 60947-5-1:2004 + AC:2005 + A1 :2009 ISO 13850:2015 ISO 13849-1 :2015 ISO 13849-2:2012	
Notified body for the prototype test:	TÜV Rheinland Industrie Service GmbH Albainstr. 56, 12103 Berlin ID n°: 0035	
EC-prototype test certificate:	01/205/5085.01/16	
Person authorised for the compilation of the technical documentation:	Oliver Wacker Möddinghofe 30 42279 Wuppertal	
Place and date of issue:	Wuppertal, May 4, 2016	
SRB301MA-E-EN		
	Authorised signature Philip Schmersal Managing Director	



The currently valid declaration of conformity can be downloaded from the internet at www.schmersal.net.

