



EN Operating instructions.pages 1 to 6
Original

Content

1 About this document

1.1 Function 1

1.2 Target group: authorised qualified personnel. 1

1.3 Explanation of the symbols used 1

1.4 Appropriate use 1

1.5 General safety instructions 1

1.6 Warning about misuse 2

1.7 Exclusion of liability 2

2 Product description

2.1 Ordering code 2

2.2 Special versions. 2

2.3 Destination and use 2

2.4 Technical data 2

2.5 Safety classification 3

3 Mounting

3.1 General mounting instructions 3

3.2 Dimensions 3

4 Electrical connection

4.1 General information for electrical connection. 3

5 Operating principle and settings

5.1 LED functions. 3

5.2 Description of the terminals 3

5.3 Notes 4

6 Set-up and maintenance

6.1 Functional testing. 4

6.2 Maintenance 4

7 Disassembly and disposal

7.1 Disassembly. 4

7.2 Disposal 4

8 Appendix

8.1 Wiring examples 4

8.2 Sensor configuration 4

8.3 Actuator configuration 5

8.4 Flow diagram 5

9 EU Declaration of conformity

1. About this document

1.1 Function

This operating instructions manual provides all the information you need for the mounting, set-up and commissioning to ensure the safe operation and disassembly of the safety-monitoring module. The operating instructions must be available in a legible condition and a complete version in the vicinity of the device.

1.2 Target group: authorised qualified personnel

All operations described in this operating instructions manual must be carried out by trained specialist personnel, authorised by the plant operator only.

Please make sure that you have read and understood these operating instructions and that you know all applicable legislations regarding occupational safety and accident prevention prior to installation and putting the component into operation.

The machine builder must carefully select the harmonised standards to be complied with as well as other technical specifications for the selection, mounting and integration of the components.

1.3 Explanation of the symbols used



Information, hint, note:

This symbol is used for identifying useful additional information.



Caution: Failure to comply with this warning notice could lead to failures or malfunctions.

Warning: Failure to comply with this warning notice could lead to physical injury and/or damage to the machine.

1.4 Appropriate use

The products described in these operating instructions are developed to execute safety-related functions as part of an entire plant or machine. It is the responsibility of the manufacturer of a machine or plant to ensure the correct functionality of the entire machine or plant.

The safety-monitoring module must be exclusively used in accordance with the versions listed below or for the applications authorised by the manufacturer. Detailed information regarding the range of applications can be found in the chapter "Product description".

1.5 General safety instructions

The user must observe the safety instructions in this operating instructions manual, the country-specific installation standards as well as all prevailing safety regulations and accident prevention rules.



Further technical information can be found in the online catalogue on the Internet: www.schmersal.net.

The information contained in this operating instructions manual is provided without liability and is subject to technical modifications.

There are no residual risks, provided that the safety instructions as well as the instructions regarding mounting, commissioning, operation and maintenance are observed.

1.6 Warning about misuse



In case of inadequate or improper use or manipulations of the safety-monitoring module, personal hazards or damage to machinery or plant components cannot be excluded. The relevant requirements of the standards ISO 14119 and ISO 13850 must be observed.

1.7 Exclusion of liability

We shall accept no liability for damages and malfunctions resulting from defective mounting or failure to comply with this operating instructions manual. The manufacturer shall accept no liability for damages resulting from the use of unauthorised spare parts or accessories.

For safety reasons, invasive work on the device as well as arbitrary repairs, conversions and modifications to the device are strictly forbidden; the manufacturer shall accept no liability for damages resulting from such invasive work, arbitrary repairs, conversions and/or modifications to the device.

The safety-monitoring module must only be used when the enclosure is closed, i.e. with the front cover fitted.

2. Product description

2.1 Ordering code

This operating instructions manual applies to the following types:

SRB201ZH -24VDC



Only if the information described in this operating instructions manual are realised correctly, the safety function and therefore the compliance with the Machinery Directive is maintained.

2.2 Special versions

For special versions, which are not listed in the order code below 2.1, these specifications apply accordingly, provided that they correspond to the standard version.

2.3 Destination and use

The safety-monitoring modules for integration in safety circuits are designed for fitting in control cabinets. They are used for the safe evaluation of the signals of two actuating elements A + B and correspond to a type III/C two-hand control to EN 574.

The safety function is defined as the opening of the enabling circuits 13-14 and 23-24 when one or both actuating elements A + B are released. The safety-relevant current paths with the output contacts 13-14 and 23-24 meet the following requirements under observation of a PFH value assessment (also refer to chapter 2.5 "Safety classification"):

- Control category 4 – PL e to ISO 13849-1
- corresponds to SIL 3 to IEC 61508-2
- SILCL 3 to EN 62061

To determine the Performance Level (PL) to ISO 13849-1 of the entire safety function (e.g. sensor, logic, actuator), an assessment of all relevant components is required.



The entire concept of the control system, in which the safety component is integrated, must be validated to the relevant standards.

2.4 Technical data

General data

Standards:	EN 60204-1, IEC 60947-5-1; ISO 13849-1, IEC 61508
Climate resistance:	EN 60068-2-78
Mounting:	snaps onto standard DIN rail to EN 60715
Terminal designations:	IEC 60947-1
Material of the housings:	Plastic, glass-fibre reinforced thermoplastic, ventilated
Material of the contacts:	AgSnO, self-cleaning, positive drive
Weight:	200 g
Start conditions:	Automatic
Feedback circuit (Y/N):	yes
Pull-in delay for automatic start:	typ. 50 ms
Response time:	typ. 30 ms, max. 37 ms
Bridging in case of voltage drops:	typ. 30 ms
Simultaneity monitoring:	≤ 0.5 s

Mechanical data

Connection type:	Screw connection
Cable section:	min. 0.25 mm ² / max. 2.5 mm ²
Connecting cable:	rigid or flexible
Tightening torque for the terminals:	0.6 Nm
With removable terminals (Y/N):	yes
Mechanical life:	10 million operations
Electrical life:	Derating curve available on request
Resistance to shock:	30 g / 11 ms
Resistance to vibrations to EN 60068-2-6:	10 ... 55 Hz, amplitude 0.35 mm

Ambient conditions

Ambient temperature:	-25 °C ... +60 °C
Storage and transport temperature:	-40 °C ... +85 °C
Protection class:	Enclosure: IP40 Terminals: IP20 Clearance: IP54

Air clearances and creepage distances

to IEC 60664-1:	4 kV/2 (basic insulation)
EMC rating:	to EMC Directive

Electrical data

Contact resistance in new state:	max. 100 mΩ
Power consumption:	max. 1.2 W
Rated operating voltage U _e :	24 VDC -10%/+10%, residual ripple max. 10%
Fuse rating for the operating voltage:	Internal electronic trip: F1, F2: tripping current > 0.2 A F3: tripping current > 0.6 A

Monitored inputs

Cross-wire detection (Y/N):	Yes
Wire breakage detection (Y/N):	Yes
Earth leakage detection (Y/N):	Yes
Number of NO contacts:	2
Number of NC contacts:	2
Cable length:	1,500 m with 1.5 mm ² 2,500 m with 2.5 mm ²
Conduction resistance:	max. 40 Ω

Outputs

Number of safety contacts:	2 (13-14; 23-24)
Number of auxiliary contacts:	1 (31-32)
Number of signalling outputs:	0
Switching capacity of the safety contacts:	max. 250 V, 6 A ohmic (inductive in case of appropriate protective wiring); min. 10 V / 10 mA
Switching capacity of the auxiliary contacts:	24 VDC / 2 A
Fuse rating of the safety contacts:	external ($I_k = 1000$ A) to IEC 60947-5-1 Safety fuse 8 A quick blow, 6.3 A slow blow
Fuse rating for the auxiliary contacts:	2.5 A quick blow, 2 A slow blow
Utilisation category to IEC 60947-5-1:	AC-15: 230 V / 6 A DC-13: 24 V / 6 A
Dimensions H x W x D:	100 x 22.5 x 121 mm

The data specified in this manual are applicable when the component is operated with rated operating voltage $U_e \pm 0\%$.

2.5 Safety classification

Standards:	ISO 13849-1, IEC 61508
PL:	up to e
Control category:	up to 4
DC:	99% (high)
CCF:	> 65 points
PFH:	$\leq 2.00 \times 10^{-8}/h$
SIL:	up to 3
Service life:	20 years

The PFH value of $2.00 \times 10^{-8}/h$ applies to the combinations of contact load (current through enabling contacts) and number of switching cycles (n_{oply}) mentioned in the table below. At 365 operating days per year and a 24-hours operation, this results in the below-mentioned switching cycle times (t_{cycle}) for the relay contacts. Diverging applications upon request.

Contact load	n_{oply}	t_{cycle}
20 %	525,600	1.0 min
40 %	210,240	2.5 min
60 %	75,087	7.0 min
80 %	30,918	17.0 min
100 %	12,223	43.0 min

3. Mounting

3.1 General mounting instructions

Mounting: snaps onto standard DIN rails to EN 60715.

Snap the bottom of the enclosure slightly tilted forwards in the DIN rail and push up until it latches in position.

3.2 Dimensions

All measurements in mm.

Device dimensions (H/W/D): 100 x 22.5 x 121 mm
with plugged-in terminals: 120 x 22.5 x 121 mm

4. Electrical connection

4.1 General information for electrical connection



The electrical connection may only be carried out by authorised personnel in a de-energised condition.



As far as the electrical safety is concerned, the protection against unintentional contact of the connected and therefore electrically interconnected apparatus and the insulation of the feed cables must be designed for the highest voltage, which can occur in the device.



To avoid EMC disturbances, the physical ambient and operational conditions at the place where the product is installed, must meet the provisions laid down in the paragraph "Electromagnetic Compatibility (EMC)" of DIN EN 60204-1.

Wiring examples: see appendix

5. Operating principle and settings

5.1 LED functions

K1: Status channel 1

K2: Status channel 2

5.2 Description of the terminals

Voltages:	A1	+24 VDC
	A1.1	+ 24 V
	A2	0 VDC
	A2.1	0 V
Inputs:	S11	Input channel 1 (+)
	S12	Input channel 1 (-)
	S21	Input channel 2 (-)
	S22	Input channel 2 (+)
Outputs:	13 - 14	First safety enabling circuit
	23 - 24	Second safety enabling circuit
	31 - 32	Auxiliary NC contact as signalling contact
Start:	X1 - X2	Feedback circuit

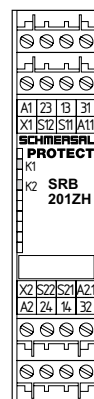

Fig. 1

5.3 Notes



Signalling outputs must not be used in safety circuits.



The NC contact of the buttons A + B must be opened, before the NO contact closes. No overlapping contacts to avoid triggering of the fuses F1 and F2.



The pushbuttons A + B must be actuated within a timeframe of ≤ 0.5 sec (simultaneous operation monitoring), otherwise no start enabling signal is given!

6. Set-up and maintenance

6.1 Functional testing

The safety function of the safety-monitoring module must be tested. The following conditions must be previously checked and met:

1. Correct fixing
2. Check the integrity of the cable entry and connections
3. Check the safety-monitoring module's enclosure for damage.
4. Check the electrical function of the connected sensors and their influence on the safety-monitoring module and the downstream actuators

6.2 Maintenance

A regular visual inspection and functional test, including the following steps, is recommended:

1. Check the correct fixing of the safety-monitoring module
2. Check the cable for damages
3. Check electrical function



If a manual functional check is necessary to detect a possible accumulation of faults, then this must take place during the intervals noted as follows:

- at least every month for PL e with category 3 or category 4 (according to ISO 13849-1) or SIL 3 with HFT (hardware fault tolerance) = 1 (according to IEC 62061);
- at least every 12 months for PL d with category 3 (according to ISO 13849-1) or SIL 2 with HFT (hardware fault tolerance) = 1 (according to IEC 62061).

Damaged or defective components must be replaced.

7. Disassembly and disposal

7.1 Disassembly

The safety-monitoring module must be disassembled in a de-energised condition only.

Push up the bottom of the enclosure and hang out slightly tilted forwards.

7.2 Disposal

The safety-monitoring module must be disposed of in an appropriate manner in accordance with the national prescriptions and legislations.

8. Appendix

8.1 Wiring examples

Dual-channel control with two pushbuttons A and B (see Fig. 2)

- Relay outputs: Suitable for 2-channel control, for increase in capacity or number of contacts by means of contactors or relays with positive-guided contacts.
- Ⓜ = Feedback circuit

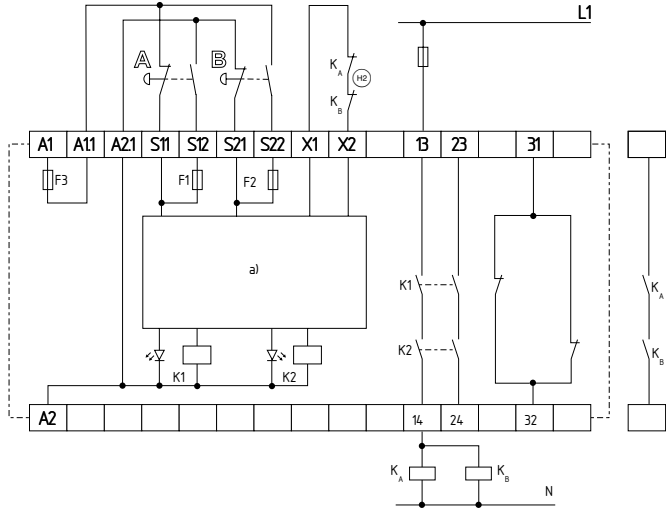

Fig. 2 a) Logic

8.2 Sensor configuration

Two-hand control to EN 574 and EN 60204-1 (see Fig. 3)

- Malfunctions of every contact as well as earth leakages and cross-wire shorts are detected.
- Feedback circuit Ⓜ : the feedback circuit is integrated as shown. The safety-technical function of external positive-guided contactors is monitored by a series-wiring of the NC contacts with the terminals X1 and X2. In idle state, this circuit must be closed. If the feedback circuit is not required, establish a bridge.
- Safety category III/C to EN 574
- Category 4 – PL e to ISO 13849-1 possible.

Two-hand control to EN 574 and EN 60204-1 (see Fig. 4)

- Malfunctions of every contact as well as earth leakages and cross-wire shorts are detected.
- Feedback circuit Ⓜ : the feedback circuit is integrated as shown. The safety-technical function of external positive-guided contactors is monitored by a series-wiring of the NC contacts with the terminals X1 and X2. In idle state, this circuit must be closed. If the feedback circuit is not required, establish a bridge.
- Safety category III/C to EN 574
- Category 4 – PL e to ISO 13849-1 possible.

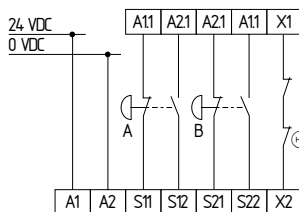

Fig. 3

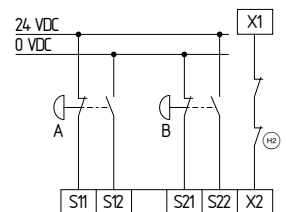

Fig. 4

8.3 Actuator configuration

Single-channel control with feedback circuit (Fig. 5)

- Suitable for increase in capacity or number of contacts by means of contactors or relays with positive-guided contacts.
- \ominus = feedback circuit:
 If the feedback circuit is not required, establish a bridge.

Dual-channel control with feedback circuit (Fig. 6)

- Suitable for increase in capacity or number of contacts by means of contactors or relays with positive-guided contacts.
- \ominus = feedback circuit:
 If the feedback circuit is not required, establish a bridge.

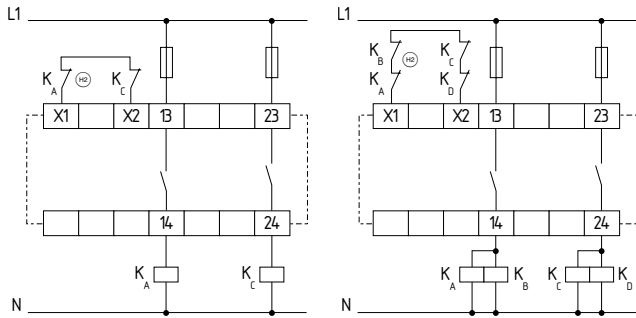

Fig. 5

Fig. 6

Differential control with feedback circuit (see Fig. 7)

- Suitable for increase in capacity or number of contacts by means of contactors or relays with positive-guided contacts.
- \ominus = feedback circuit:
 If the feedback circuit is not required, establish a bridge.

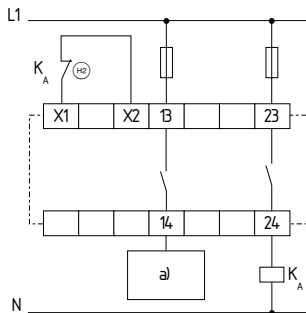

Fig. 7 a) Enabling signal controller

8.4 Flow diagram

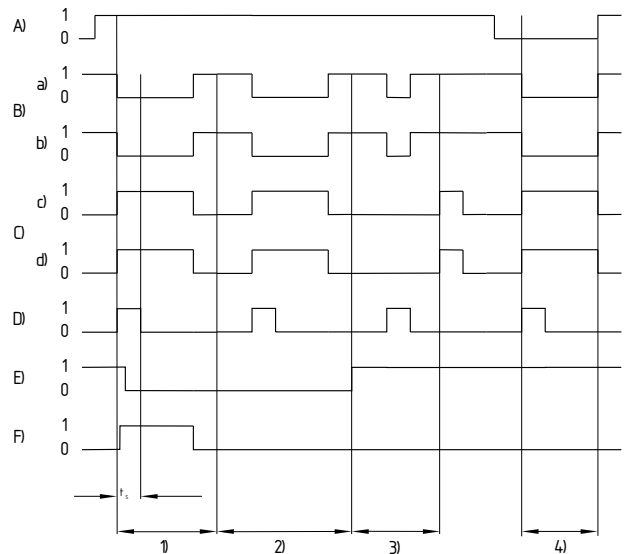

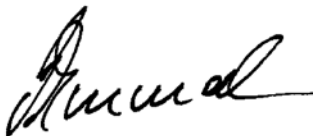

Fig. 8

Key

- 1) uninterrupted workcycle;
 - 2) Fault in feedback circuit;
 - 3) Synchronous actuation fault $t > 0.5$ s
 - 4) Fault button A, B before $U_{B\text{in}}$;
- A) Operating voltage U_B ;
 B) Two-hand button A: the representation is related to the potentials at the terminals of the safety-monitoring module;
 a) NC contact S11; b) NO contact S12;
 C) Two-hand button B: the representation is related to the potentials at the terminals of the safety-monitoring module;
 c) NC contact S21; d) NO contact S22;
 D) Simultaneity monitoring t_s (synchronous actuation);
 E) Feedback circuit X1-X2;
 F) Output contacts 13-14, 23-24 potential-free

9. EU Declaration of conformity

EU Declaration of conformity		
Original	K.A. Schmersal GmbH & Co. KG Möddinghofe 30 42279 Wuppertal Germany Internet: www.schmersal.com	
We hereby certify that the hereafter described components both in their basic design and construction conform to the applicable European Directives.		
Name of the component:	SRB201ZH -24VDC	
Description of the component:	Safety switchgear for two-hand applications	
Relevant Directives:	Machinery Directive	2006/42/EC
	EMC-Directive	2014/30/EU
	RoHS-Directive	2011/65/EU
Applied standards:	EN 574:1996 + A1:2008, ISO 13851:2002, EN ISO 13849-1:2015, EN ISO 13849-2:2012, IEC 61326-3-1:2017	
Notified body for the prototype test:	TÜV Rheinland Industrie Service GmbH Alboinstr. 56, 12103 Berlin ID n°: 0035	
EC-prototype test certificate:	01/205/5316.01/18	
Person authorised for the compilation of the technical documentation:	Oliver Wacker Möddinghofe 30 42279 Wuppertal	
Place and date of issue:	Wuppertal, July 12, 2018	
SRB201ZH-24VDC-F-EN		
	Authorised signature Philip Schmersal Managing Director	



The currently valid declaration of conformity can be downloaded from the internet at www.schmersal.net.



K. A. Schmersal GmbH & Co. KG
Möddinghofe 30, D - 42279 Wuppertal
Postfach 24 02 63, D - 42232 Wuppertal

Phone: +49 - (0)2 02 - 64 74 - 0
Telefax: +49 - (0)2 02 - 64 74 - 1 00
E-Mail: info@schmersal.com
Internet: <http://www.schmersal.com>