

Datasheet - AZM 170SK-11/02ZRK-2197 24VAC/DC

Solenoid interlock / AZM 170



- Thermoplastic enclosure
- Double-insulated
- Compact design
- 90 mm x 84 mm x 30 mm
- 1 Cable entry M 20 x 1.5
- Interlock with protection against incorrect locking.
- Long life
- High holding force
- Manual release from side
- Screw connection

(Minor differences between the printed image and the original product may exist!)

Ordering details

Product type description	AZM 170SK-11/02ZRK-2197 24VAC/DC
Article number	101183249
EAN Code	4030661319049
eCl@ss	27-27-26-03

Approval

Approval

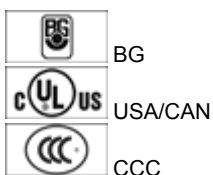

Classification

Standards	EN ISO 13849-1
B10d Normally-closed contact (NC)	2.000.000
Mission time	20 Years
notice	$MTTF_d = \frac{B_{10d}}{0,1 \times n_{op}}$ $n_{op} = \frac{d_{op} \times h_{op} \times 3600 \text{ s/h}}{t_{cycle}}$

Global Properties

Permanent light	AZM 170
Standards	EN 60947-5-1, BG-GS-ET-19
Compliance with the Directives (Y/N) 	Yes
Number of actuating directions	2
Active principle	electromechanical
Duty cycle ED	Magnet 100 %
Materials	
- Material of the housings	Plastic, glass-fibre reinforced thermoplastic, self-extinguishing
- Material of the contacts	Silver
Housing coating	None
Weight	320

Mechanical data

Design of electrical connection	Screw connection
Cable section	
- Min. Cable section	1 x 0,25
- Max. Cable section	1 x 1.5, flexible
Mechanical life	> 1.000.000 operations
Emergency unlocking device (Y/N)	No
Manual release (Y/N)	Yes
- right	
Emergency release (Y/N)	No
Latching force	30
Positive break force	17
positive break travel	11 mm
Clamping force F	1000 N
Max. Actuating speed	2 m/s

Ambient conditions

Ambient temperature	
- Min. environmental temperature	-25 °C
- Max. environmental temperature	+60 °C
Protection class	IP67 to IEC/EN 60529

Electrical data

Design of control element	Normally open contact (NO), Opener (NC)
notice	change-over contact with double break, type Zb or 2 NC contacts, with galvanically separated contact bridges
Switching principle	Creep circuit element
Number of auxiliary contacts	1
Number of safety contacts	3
Power to unlock	Yes
Power to lock	No
Rated control voltage U_s	24 VAC/DC
Power consumption	max. 10 W
Rated impulse withstand voltage U_{imp}	4 kV
Rated insulation voltage U_i	250 V
Thermal test current I_{the}	10 A
Utilisation category	AC-15: 230 V / 4 A DC-13: 24 V / 4 A
Max. fuse rating	6 A gG D-fuse

ATEX

Explosion protection categories for gases	None
Explosion protected category for dusts	None

Miscellaneous data

Applications	 sliding safety guard,
	 removable guard,
	 hinged safety guard

Dimensions

Dimensions of the sensor	
- Width of sensor	108
- Height of sensor	100.5
- Length of sensor	30 mm

notice

Individual coding available on request

Manual release from side

- For manual release using M5 triangular key, available as accessory
- Additional manual release on side

Diagram

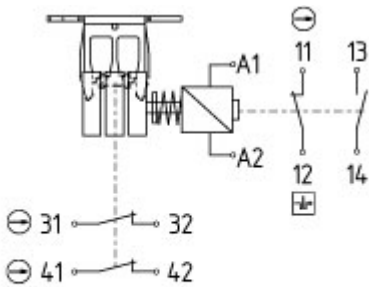

11	12	13	14	31	32	41	42	A1	A2
----	----	----	----	----	----	----	----	----	----

Note Diagram

 positive break NC contact

 active

 no active

 Normally-open contact

 Normally-closed contact

Ordering suffix

The applicable ordering suffix is added at the end of the part number of the safety switch.
Order example: AZM 170SK-11/02ZRK-2197 24VAC/DC-**1637**

...-1637

0,3 µm gold-plated contacts

...ST-2431

connector M12 , Individual solenoid monitoring

Ordering code

AZM 170(1)-(2)Z(3)K(4)-(5)-(6)-(7)

(1)

without

SK

IDC method of termination

Screw connection

(2)

11

1 Normally open contact (NO) / 1 Opener (NC)

02

2 Opener (NC)

12/0.0

1 Normally open contact (NO), 2 Opener (NC) / -

(3)

without

R

Latching force 5 N

I

Latching force 30 N

Individual coding

(4)

without

A

Power to unlock

Power to lock

(5)

without

ST

cable gland

Connector M12 x 1

ST-2431

Connector M12 x 1, Individual solenoid monitoring

(6)

24VAC/DC

U_s 24 VAC/DC

110VAC

U_s 110 VAC

230VAC

U_s 230 VAC

(7)

without

2197

Manual release

Manual release from side (Power to unlock)

1637

gold-plated contacts

AZM 170ST and AZM 170SK

AZM 170ST-(1)Z(2)K(3)-(4)-(5)-024

AZM 170SK-(1)Z(2)K(3)-(4)-(5)-024

(1)

11/11

1 Normally open contact (NO), 1 Opener (NC) / 1 Normally open contact (NO), 1 Opener (NC)

11/02

1 Normally open contact (NO), 1 Opener (NC) / 2 Opener (NC)

12/00

1 Normally open contact (NO), 2 Opener (NC) / -

12/11

1 Normally open contact (NO), 2 Opener (NC) / 1 Normally open contact (NO), 1 Opener (NC)

12/02

1 Normally open contact (NO), 2 Opener (NC) / 2 Opener (NC)

02/01

2 Opener (NC), - / 1 Opener (NC), -

02/10

2 Opener (NC), - / 1 Normally open contact (NO), -

(2)

without

R

Latching force 5 N

Latching force 30 N

(3)

<i>without</i>	Power to unlock
A	Power to lock
(4)	
1637	gold-plated contacts
(5)	
2197	Manual release for Power to unlock

Documents

Operating instructions and Declaration of conformity (en) 634 kB, 23.05.2019

Code: mrl_azm170-xx-xx_en

Operating instructions and Declaration of conformity (da) 509 kB, 24.11.2015

Code: mrl_azm170-xx-xx_da

Operating instructions and Declaration of conformity (it) 631 kB, 28.05.2019

Code: mrl_azm170-xx-xx_it

Operating instructions and Declaration of conformity (nl) 532 kB, 29.06.2018

Code: mrl_azm170-xx-xx_nl

Operating instructions and Declaration of conformity (de) 605 kB, 23.05.2019

Code: mrl_azm170-xx-xx_de

Operating instructions and Declaration of conformity (cs) 546 kB, 24.11.2015

Code: mrl_azm170-xx-xx_cs

Operating instructions and Declaration of conformity (pt) 636 kB, 04.06.2019

Code: mrl_azm170-xx-xx_pt

Operating instructions and Declaration of conformity (jp) 601 kB, 07.09.2016

Code: mrl_azm170-xx-xx_jp

Operating instructions and Declaration of conformity (fr) 511 kB, 28.04.2016

Code: mrl_azm170-xx-xx_fr

Operating instructions and Declaration of conformity (es) 656 kB, 31.05.2019

Code: mrl_azm170-xx-xx_es

Operating instructions and Declaration of conformity (pl) 691 kB, 31.05.2019

Code: mrl_azm170-xx-xx_pl

Operating instructions and Declaration of conformity (cn) 544 kB, 05.05.2017

Code: mrl_azm170-xx-xx_cn

BG-test certificate (en) 260 kB, 09.12.2015

Code: z_m17p02

BG-test certificate (de) 257 kB, 09.12.2015

Code: z_m17p01

CCC certification (en) 5 MB, 26.10.2018

Code: q_371p02

CCC certification (cn) 5 MB, 26.10.2018

Code: q_371p03

EAC certification (ru) 809 kB, 05.10.2015

Code: q_6040p17_ru

Images

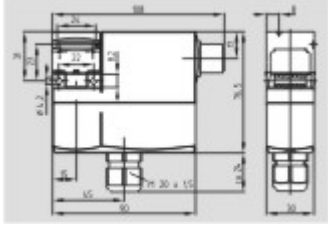

Dimensional drawing (basic component)

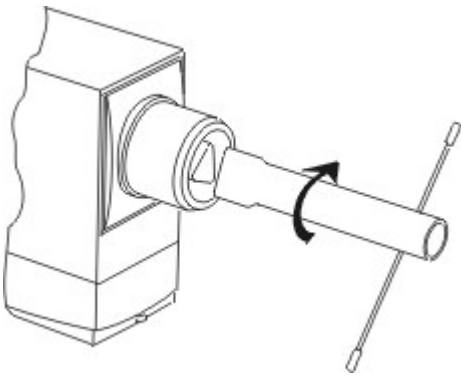

Detail photo

System components

Actuator



101122893 - AZ 17/170-B1

- Particularly suitable for sliding doors
-



101137406 - AZ 17/170-B1-2245

- Particularly suitable for sliding doors
 - Damps vibration on guard device
-



101122895 - AZ 17/170-B5

- Particularly suitable for sliding doors
-

101139788 - AZ 17/170-B11



- Particularly suitable for sliding doors



101139789 - AZ 17/170-B15

- Particularly suitable for sliding doors



101123391 - AZM 170-B6

- Particularly suitable for hinged guards
- For very small actuating radii
- The direction of actuation can be selected by applicable insertion of the insert

Accessories



101208493 - AZM 170-B CENTERING GUIDE

- for AZ 17 and AZM 170



101100887 - TRIANGULAR KEY TK-M5

- For manual release using M5 triangular key, available as accessory
- For maintenance, installation, etc.

Connector



A-K4M12

- Pre-wired cable
- 4-pole



S-K4M12

- Connector without cable
- 4-pole