

Datasheet - AZM 170-11ZRK-ST-2197 24 VAC/DC



Solenoid interlock / AZM 170

Preferred typ



- Thermoplastic enclosure
- Double-insulated
- Compact design
- 90 mm x 84 mm x 30 mm
- Interlock with protection against incorrect locking.
- Long life
- High holding force
- Manual release from side
- Connector M12, 4-pole

(Minor differences between the printed image and the original product may exist!)

Ordering details

Product type description	AZM 170-11ZRK-ST-2197 24 VAC/DC
Article number	101141425
EAN Code	4030661121918
eCl@ss	27-27-26-03

Approval

Approval

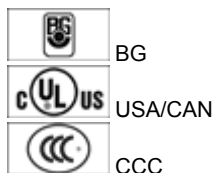

Classification

Standards	EN ISO 13849-1
B10d Normally-closed contact (NC)	2.000.000
Mission time	20 Years
notice	$MTTF_d = \frac{B_{10d}}{0,1 \times n_{op}}$ $n_{op} = \frac{d_{op} \times h_{op} \times 3600 \text{ s/h}}{t_{cycle}}$

Global Properties

Permanent light	AZM 170
-----------------	---------

Standards	EN 60947-5-1, BG-GS-ET-19
Compliance with the Directives (Y/N) 	Yes
Number of actuating directions	2
Active principle	electromechanical
Duty cycle ED	Magnet 100 %
Materials	
- Material of the housings	Plastic, glass-fibre reinforced thermoplastic, self-extinguishing
- Material of the contacts	Silver
Housing coating	None
Weight	295

Mechanical data

Design of electrical connection	Connector M12
Mechanical life	> 1.000.000 operations
Emergency unlocking device (Y/N)	No
Manual release (Y/N)	Yes
- bottom	
- right	
Emergency release (Y/N)	No
Latching force	30
Positive break force	8.5
positive break travel	11 mm
Clamping force F	1000 N
Max. Actuating speed	2 m/s

Ambient conditions

Ambient temperature	
- Min. environmental temperature	-25 °C
- Max. environmental temperature	+60 °C
Protection class	IP67 to IEC/EN 60529

Electrical data

Design of control element	Normally open contact (NO), Opener (NC)
notice	change-over contact with double break, type Zb or 2 NC contacts, with galvanically separated contact bridges
Switching principle	Creep circuit element
Number of auxiliary contacts	1
Number of safety contacts	1
Power to unlock	Yes
Power to lock	No
Rated control voltage U_s	24 VAC/DC
Power consumption	max. 10 W
Rated impulse withstand voltage U_{imp}	4 kV
Rated insulation voltage U_i	250 V
Thermal test current I_{the}	10 A
Utilisation category	AC-15: 230 V / 4 A, DC-13: 24 V / 4 A
Max. fuse rating	6 A gG D-fuse

ATEX

Explosion protection categories for gases	None
---	------

Miscellaneous data

Applications



sliding safety guard,



removable guard,



hinged safety guard

Dimensions

Dimensions of the sensor

- Width of sensor	108
- Height of sensor	75.5
- Length of sensor	30 mm

notice

Individual coding available on request

Manual release from side

- For manual release using M5 triangular key, available as accessory
- Additional manual release on side

Diagram

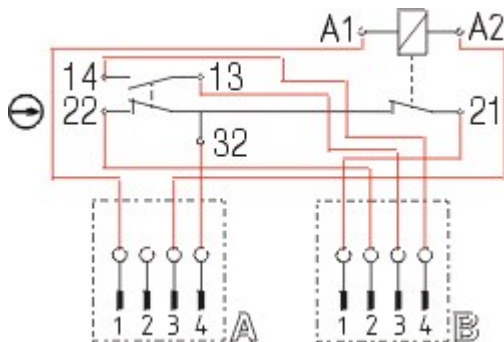

Note Diagram

positive break NC contact

active

no active

Normally-open contact

Normally-closed contact

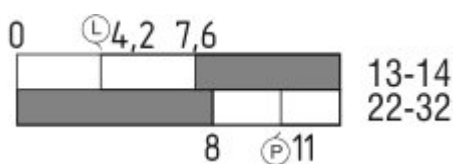

Switch travel diagram



Notes Switch travel diagram

Contact closed

Contact open

-  Setting range
-  Break point
-  Positive opening sequence/- angle
- VS** adjustable range of NO contact
- VÖ** adjustable range of NC contact
- N** after travel

Ordering suffix

The applicable ordering suffix is added at the end of the part number of the safety switch.
 Order example: AZM 170-11ZRK-ST-2197 24 VAC/DC-**1637**

...- 1637	0,3 µm gold-plated contacts
... ST-2431	connector M12 , Individual solenoid monitoring

Ordering code

AZM 170(1)-(2)Z(3)K(4)-(5)-(6)-(7)

(1) <i>without</i> SK	IDC method of termination Screw connection
(2) 11 02 12/0.0	1 Normally open contact (NO) / 1 Opener (NC) 2 Opener (NC) 1 Normally open contact (NO), 2 Opener (NC) / -
(3) <i>without</i> R I	Latching force 5 N Latching force 30 N Individual coding
(4) <i>without</i> A	Power to unlock Power to lock
(5) <i>without</i> ST ST-2431	cable gland Connector M12 x 1 Connector M12 x 1, Individual solenoid monitoring
(6) 24VAC/DC 110VAC 230VAC	U _s 24 VAC/DC U _s 110 VAC U _s 230 VAC
(7) <i>without</i> 2197 1637	Manual release Manual release from side (Power to unlock) gold-plated contacts

AZM 170ST and AZM 170SK

AZM 170ST-(1)Z(2)K(3)-(4)-(5)-024

AZM 170SK-(1)Z(2)K(3)-(4)-(5)-024

(1) 11/11	1 Normally open contact (NO), 1 Opener (NC) / 1 Normally open contact
---------------------	---

	(NO), 1 Opener (NC)
11/02	1 Normally open contact (NO), 1 Opener (NC) / 2 Opener (NC)
12/00	1 Normally open contact (NO), 2 Opener (NC) / -
12/11	1 Normally open contact (NO), 2 Opener (NC) / 1 Normally open contact (NO), 1 Opener (NC)
12/02	1 Normally open contact (NO), 2 Opener (NC) / 2 Opener (NC)
02/01	2 Opener (NC), - / 1 Opener (NC), -
02/10	2 Opener (NC), - / 1 Normally open contact (NO), -
(2)	
<i>without</i>	Latching force 5 N
R	Latching force 30 N
(3)	
<i>without</i>	Power to unlock
A	Power to lock
(4)	
1637	gold-plated contacts
(5)	
2197	Manual release for Power to unlock

Documents

Operating instructions and Declaration of conformity (fr) 701 kB, 15.02.2018

Code: mrl_azm170_fr

Operating instructions and Declaration of conformity (de) 672 kB, 20.05.2019

Code: mrl_azm170_de

Operating instructions and Declaration of conformity (it) 718 kB, 06.06.2019

Code: mrl_azm170_it

Operating instructions and Declaration of conformity (cn) 655 kB, 08.05.2017

Code: mrl_azm170_cn

Operating instructions and Declaration of conformity (nl) 702 kB, 12.07.2018

Code: mrl_azm170_nl

Operating instructions and Declaration of conformity (en) 702 kB, 20.05.2019

Code: mrl_azm170_en

Operating instructions and Declaration of conformity (jp) 843 kB, 23.08.2016

Code: mrl_azm170_jp

Operating instructions and Declaration of conformity (pl) 736 kB, 14.06.2018

Code: mrl_azm170_pl

Operating instructions and Declaration of conformity (da) 582 kB, 07.08.2012

Code: mrl_azm170_da

Operating instructions and Declaration of conformity (es) 719 kB, 31.05.2019

Code: mrl_azm170_es

BG-test certificate (en) 260 kB, 09.12.2015

Code: z_m17p02

BG-test certificate (de) 257 kB, 09.12.2015

Code: z_m17p01

CCC certification (en) 5 MB, 26.10.2018

Code: q_371p02

CCC certification (cn) 5 MB, 26.10.2018

Code: q_371p03

EAC certification (ru) 809 kB, 05.10.2015

Code: q_6040p17_ru

Images

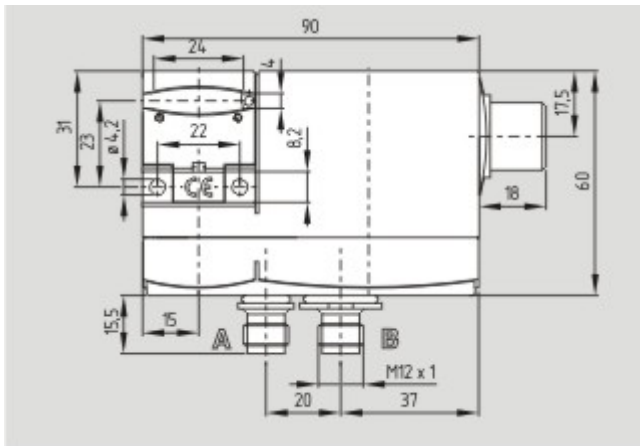

Dimensional drawing (basic component)

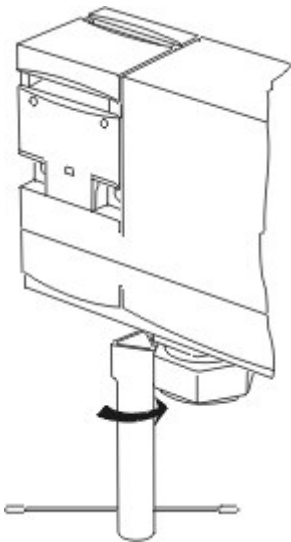

Detail photo

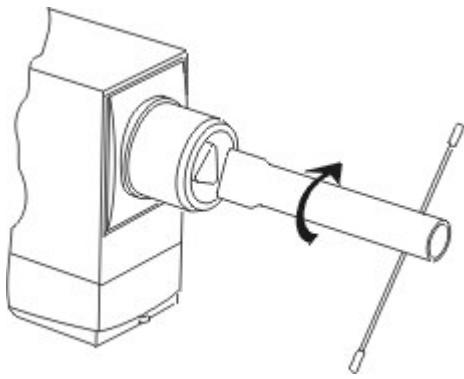

Detail photo

System components

Actuator



101122893 - AZ 17/170-B1

- Particularly suitable for sliding doors



101137406 - AZ 17/170-B1-2245

- Particularly suitable for sliding doors
- Damps vibration on guard device



101122895 - AZ 17/170-B5

- Particularly suitable for sliding doors



101139788 - AZ 17/170-B11

- Particularly suitable for sliding doors



101139789 - AZ 17/170-B15

- Particularly suitable for sliding doors

101123391 - AZM 170-B6

- Particularly suitable for hinged guards
- For very small actuating radii
- The direction of actuation can be selected by applicable insertion of



the insert

Accessories



101208493 - AZM 170-B CENTERING GUIDE

- for AZ 17 and AZM 170



101100887 - TRIANGULAR KEY TK-M5

- For manual release using M5 triangular key, available as accessory
- For maintenance, installation, etc.

Connector



A-K4M12

- Pre-wired cable
- 4-pole



S-K4M12

- Connector without cable
- 4-pole



A-K4M12

- Pre-wired cable
- 4-pole



S-K4M12

- Connector without cable
- 4-pole