

## Datasheet - AZM 170-11ZRK 110 VAC

Solenoid interlock / AZM 170



- Thermoplastic enclosure
- Double-insulated 
- Compact design
- 90 mm x 84 mm x 30 mm
- 1 Cable entry M 20 x 1.5
- Interlock with protection against incorrect locking.
- Long life
- High holding force
- IDC method of termination
- Manual release

(Minor differences between the printed image and the original product may exist!)

### Ordering details

Product type description	AZM 170-11ZRK 110 VAC
Article number	101136324
EAN Code	4030661056357
eCl@ss	27-27-26-03

### Approval

Approval

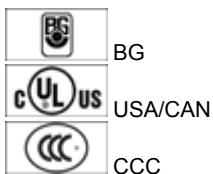

### Classification

Standards	EN ISO 13849-1
B10d Normally-closed contact (NC)	2.000.000
Mission time	20 Years
notice	$MTTF_d = \frac{B_{10d}}{0,1 \times n_{op}}$ $n_{op} = \frac{d_{op} \times h_{cp} \times 3600 \text{ s/h}}{t_{cycle}}$

### Global Properties

Permanent light	AZM 170
Standards	EN 60947-5-1, BG-GS-ET-19
Compliance with the Directives (Y/N) 	Yes
Number of actuating directions	2
Active principle	electromechanical
Duty cycle ED	Magnet 100 %
Materials	
- Material of the housings	Plastic, glass-fibre reinforced thermoplastic, self-extinguishing
- Material of the contacts	Silver
Housing coating	None
Weight	274

## Mechanical data

Design of electrical connection	IDC method of termination
Cable section	
- Min. Cable section	1 x 0,75
- Max. Cable section	1 x 1.0, flexible
Mechanical life	> 1.000.000 operations
Emergency unlocking device (Y/N)	No
- bottom	
Manual release (Y/N)	Yes
Emergency release (Y/N)	No
Latching force	30
Positive break force	8.5
positive break travel	11 mm
Clamping force F	1000 N
Max. Actuating speed	2 m/s

## Ambient conditions

Ambient temperature	
- Min. environmental temperature	-25 °C
- Max. environmental temperature	+60 °C
Protection class	IP67 to IEC/EN 60529

## Electrical data

Design of control element	Normally open contact (NO), Opener (NC)
notice	change-over contact with double break, type Zb or 2 NC contacts, with galvanically separated contact bridges
Switching principle	Creep circuit element
Number of auxiliary contacts	1
Number of safety contacts	1
Power to unlock	Yes
Power to lock	No
Rated control voltage $U_s$	110 VAC
Power consumption	max. 10 W
Rated impulse withstand voltage $U_{imp}$	4 kV
Rated insulation voltage $U_i$	250 V
Thermal test current $I_{the}$	10 A
Utilisation category	AC-15: 230 V / 4 A, DC-13: 24 V / 4 A
Max. fuse rating	6 A gG D-fuse

## ATEX

Explosion protection categories for gases	None
Explosion protected category for dusts	None

## Miscellaneous data

Applications



sliding safety guard,



removable guard,



hinged safety guard

## Dimensions

Dimensions of the sensor

- Width of sensor	90
- Height of sensor	84
- Length of sensor	30 mm

## notice

This type termination (IDC) method enables simple connection of flexible conductors without the need for the use of conductor ferrules

Individual coding available on request

Manual release

- For manual release using M5 triangular key, available as accessory

## Diagram

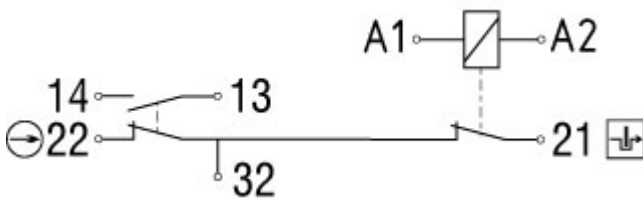

Note Diagram

- positive break NC contact
- active
- no active
- Normally-open contact
- Normally-closed contact

## Switch travel diagram

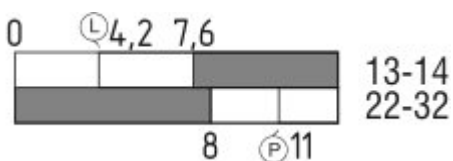

Notes Switch travel diagram

- Contact closed

- Contact open
  - Setting range
  - Break point
  - Positive opening sequence/- angle
- VS** adjustable range of NO contact  
**VÖ** adjustable range of NC contact  
**N** after travel

## Ordering suffix

---

The applicable ordering suffix is added at the end of the part number of the safety switch.  
 Order example: AZM 170-11ZRK 110 VAC-**1637**

...- <b>1637</b>	0,3 µm gold-plated contacts
... <b>ST-2431</b>	connector M12 , Individual solenoid monitoring

## Ordering code

---

AZM 170(1)-(2)Z(3)K(4)-(5)-(6)-(7)

(1) without <b>SK</b>	IDC method of termination Screw connection
(2) <b>11</b> <b>02</b> <b>12/0.0</b>	1 Normally open contact (NO) / 1 Opener (NC) 2 Opener (NC) 1 Normally open contact (NO), 2 Opener (NC) / -
(3) without <b>R</b> <b>I</b>	Latching force 5 N Latching force 30 N Individual coding
(4) without <b>A</b>	Power to unlock Power to lock
(5) without <b>ST</b> <b>ST-2431</b>	cable gland Connector M12 x 1 Connector M12 x 1, Individual solenoid monitoring
(6) <b>24VAC/DC</b> <b>110VAC</b> <b>230VAC</b>	U <sub>s</sub> 24 VAC/DC U <sub>s</sub> 110 VAC U <sub>s</sub> 230 VAC
(7) without <b>2197</b> <b>1637</b>	Manual release Manual release from side (Power to unlock) gold-plated contacts

**AZM 170ST and AZM 170SK**

**AZM 170ST-(1)Z(2)K(3)-(4)-(5)-024**

**AZM 170SK-(1)Z(2)K(3)-(4)-(5)-024**

<b>(1)</b>		
<b>11/11</b>		1 Normally open contact (NO), 1 Opener (NC) / 1 Normally open contact (NO), 1 Opener (NC)
<b>11/02</b>		1 Normally open contact (NO), 1 Opener (NC) / 2 Opener (NC)
<b>12/00</b>		1 Normally open contact (NO), 2 Opener (NC) / -
<b>12/11</b>		1 Normally open contact (NO), 2 Opener (NC) / 1 Normally open contact (NO), 1 Opener (NC)
<b>12/02</b>		1 Normally open contact (NO), 2 Opener (NC) / 2 Opener (NC)
<b>02/01</b>		2 Opener (NC), - / 1 Opener (NC), -
<b>02/10</b>		2 Opener (NC), - / 1 Normally open contact (NO), -
<b>(2)</b>		
<i>without</i>		Latching force 5 N
<b>R</b>		Latching force 30 N
<b>(3)</b>		
<i>without</i>		Power to unlock
<b>A</b>		Power to lock
<b>(4)</b>		
<b>1637</b>		gold-plated contacts
<b>(5)</b>		
<b>2197</b>		Manual release for Power to unlock

## Documents

---

**Operating instructions and Declaration of conformity** (fr) 701 kB, 15.02.2018

Code: mrl\_azm170\_fr

**Operating instructions and Declaration of conformity** (de) 672 kB, 20.05.2019

Code: mrl\_azm170\_de

**Operating instructions and Declaration of conformity** (it) 718 kB, 06.06.2019

Code: mrl\_azm170\_it

**Operating instructions and Declaration of conformity** (cn) 655 kB, 08.05.2017

Code: mrl\_azm170\_cn

**Operating instructions and Declaration of conformity** (nl) 702 kB, 12.07.2018

Code: mrl\_azm170\_nl

**Operating instructions and Declaration of conformity** (en) 702 kB, 20.05.2019

Code: mrl\_azm170\_en

**Operating instructions and Declaration of conformity** (jp) 843 kB, 23.08.2016

Code: mrl\_azm170\_jp

**Operating instructions and Declaration of conformity** (pl) 736 kB, 14.06.2018

Code: mrl\_azm170\_pl

**Operating instructions and Declaration of conformity** (da) 582 kB, 07.08.2012

Code: mrl\_azm170\_da

**Operating instructions and Declaration of conformity** (es) 719 kB, 31.05.2019

Code: mrl\_azm170\_es

**BG-test certificate** (en) 260 kB, 09.12.2015

Code: z\_m17p02

**BG-test certificate** (de) 257 kB, 09.12.2015

Code: z\_m17p01

**CCC certification** (en) 5 MB, 26.10.2018

Code: q\_371p02

**CCC certification** (cn) 5 MB, 26.10.2018

Code: q\_371p03

**EAC certification** (ru) 809 kB, 05.10.2015

Code: q\_6040p17\_ru

## Images

---

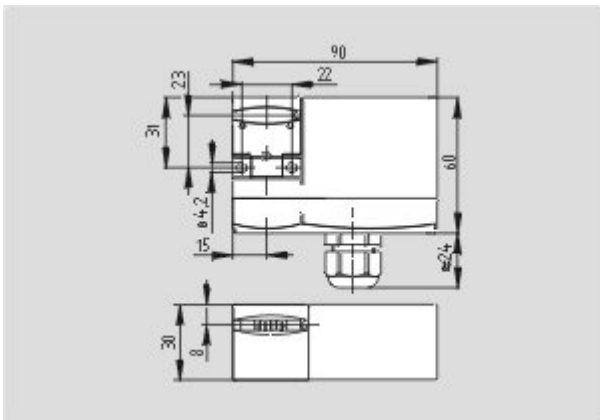

Dimensional drawing (basic component)

---

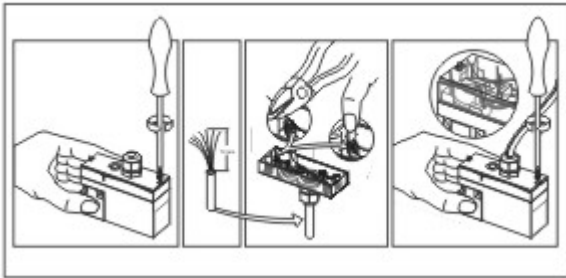

Assembly example

---

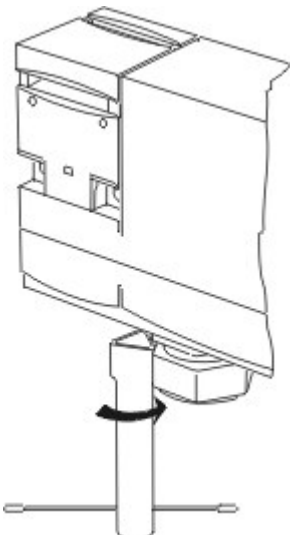

## System components

---

### Actuator



#### **101122893 - AZ 17/170-B1**

- Particularly suitable for sliding doors



#### **101137406 - AZ 17/170-B1-2245**

- Particularly suitable for sliding doors
- Damps vibration on guard device



#### **101122895 - AZ 17/170-B5**

- Particularly suitable for sliding doors



#### **101139788 - AZ 17/170-B11**

- Particularly suitable for sliding doors



#### **101139789 - AZ 17/170-B15**

- Particularly suitable for sliding doors



#### **101123391 - AZM 170-B6**

- Particularly suitable for hinged guards
- For very small actuating radii
- The direction of actuation can be selected by applicable insertion of the insert

### Accessories

#### **101208493 - AZM 170-B CENTERING GUIDE**

- for AZ 17 and AZM 170



---

#### 101100887 - TRIANGULAR KEY TK-M5

- For manual release using M5 triangular key, available as accessory
- For maintenance, installation, etc.

---

### Connector



#### A-K4M12

- Pre-wired cable
- 4-pole



#### S-K4M12

- Connector without cable
- 4-pole

---

K.A. Schmersal GmbH & Co. KG, Möddinghofe 30, D-42279 Wuppertal

The data and values have been checked thoroughly. Technical modifications and errors excepted.

Generiert am 25.07.2019 - 23:00:20h Kasbase 3.3.0.F.64l