

Product information

# OPTOELECTRONIC SAFETY GUARDS



 **SCHMERSAL**  
THE DNA OF SAFETY

# INTRODUCTION



**Heinz and Philip Schmersal,**  
Managing Directors of the Schmersal Group

## **New solutions to improve production efficiency and machine safety**

### **Safety in system – Protection for man and machine**

Often, it is unavoidable that people have to intervene with the workings of a machine. When this is done, the safety of the operator is imperative. This demands the responsibility of the machine operator, which is also required by the world's standards and guidelines for machine safety.

The Schmersal Group has concentrated for many years on safety at work with our products and solutions; today we can offer the industry the world's largest range of safety switchgear and systems for the protection of man and machine.

Under the guiding principle "Safety with system – protection for man and machine" we develop and produce products that carry the system concept and can be optimally integrated into the work processes. Because we are convinced that safety does not contradict higher productivity.

In our fields of activity we have a leading position due to our expertise, our innovative power and our comprehensive range of products. With this we follow a central theme: Together with you, we want to make the world safer.

Talk to us – we look forward to working with you.

# CONTENT

Introduction _____	Page 2
Schmersal worldwide _____	Page 4
Description _____	Page 6
Modes of operation and functions _____	Page 8
Safety distance _____	Page 10
Overview _____	Page 11
Safety light barriers _____	Page 12
Overview _____	Page 12
Preferred types and accessories _____	Page 13
Safety light grids / light curtains Type 2 _____	Page 14
Series SLC/SLG 240 _____	Page 14
Safety light grids / light curtains Type 4 _____	Page 16
Series SLC/SLG 420/422 _____	Page 16
Overview _____	Page 16
Preferred types _____	Page 18
Series SLC/SLG 440/445 _____	Page 20
Overview _____	Page 20
Preferred types _____	Page 22
Safety monitoring modules _____	Page 24
Accessories _____	Page 26
tec.nicum _____	Page 32

## Web shop



Already familiar with our new web shop?  
Here you will find all details and data  
on our products which you can order  
directly online:

[products.schmersal.com](https://products.schmersal.com)

# SCHMERSAL WORLDWIDE OFFICES IN GERMANY



## WUPPERTAL

### K.A. Schmersal GmbH & Co. KG

- Founded in 1945
- Around 710 employees

#### Focal points

- Headquarters of the Schmersal Group
- Development and manufacture of switchgears and switching systems for safety, automation and lift engineering
- Accredited test laboratory
- Central research and development
- Logistics centre for European markets



## WETTENBERG

### K.A. Schmersal GmbH & Co. KG

- Founded in 1952 (1997)
- Around 130 employees

#### Focal points

- Development and manufacture of switchgears for operation and monitoring, safety-related relay modules and controls as well as switchgears for explosion protection



## MÜHLDORF / INN

### Safety Control GmbH

- Founded in 1994 (2008)
- Around 30 employees

#### Focal points

- Development and manufacture of optical electronic components for safety and automation engineering



## BERGISCH GLADBACH

### Böhnke + Partner GmbH Steuerungssysteme

- Founded in 1991 (2013)
- Around 90 employees

#### Focal points

- Development and manufacture of components, controls and remote diagnostic systems for the lift industry

( ) = inclusion in the Schmersal Group

# SCHMERSAL WORLDWIDE INTERNATIONAL OFFICES

## BOITUVA / BRAZIL

### ACE Schmersal

- Founded in 1974
- Around 400 employees

### Focal points

- Manufacture of electromechanical and electronic switchgears
- Customer-specific control systems for the North and South American market



## SHANGHAI / CHINA

### Schmersal Industrial Switchgear Co. Ltd

- Founded in 1999
- Around 150 employees

### Focal points

- Development and manufacture of switchgears for safety, automation and lift engineering



## PUNE / INDIA

### Schmersal India Private Limited

- Founded in 2013
- Around 60 employees

### Focal points

- Development and manufacture of switchgears for safety, automation and lift engineering



# OPTOELECTRONIC SAFETY DEVICES

## DESCRIPTION

### USAGE / SELECTION OF AOPD

In order to choose the appropriate active optoelectronic protective device (AOPD) such as light barriers or light curtains/grids to use them correctly, both the requirements of the standards (EN ISO 13849-1, EN ISO 13855, C standards etc.) and product-specific features (detection sensitivity, range, etc.) must be taken into account.

AOPD's can be used, provided that:

- The dangerous movement can be stopped at all times and that it is ensured that the dangerous area can only be reached after the movement has come to a standstill.
- The stopping time for the machine and all safety components used are known.
- No objects (work pieces, liquids, etc.) can be ejected.
- The AOPD meet the requirements of Type 2 or Type 4 acc. to EN 61496.
- The dangerous area can only be reached by passing through the protected field of the AOPD.
- Reaching over, under or through the protected field is impossible.
- The start or restart command devices are fitted in such a way that the entire hazardous area is completely visible from the outside and it cannot be activated from within the hazardous area.
- The safety distance is calculated and constructively applied in accordance with EN ISO 13855.

The effectiveness of the protection equipment is only as good as the risk analysis carried out when designing the system, which took into consideration all the marginal conditions such as surroundings, machine and functional sequences.

### SAFETY LIGHT GRIDS / LIGHT CURTAINS

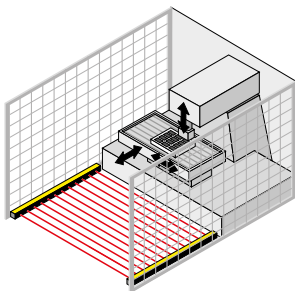

The safety light curtains and safety light grids of the SLC and SLG range meet the requirements of Category type 2 and type 4 according to EN 61496. Typical applications for safety light barriers are on robots, automatic-processing plants, transfer lines, rack storage and pallet loaders. If the light beam is interrupted by an object or a person, a stop signal is emitted to bring the machine to standstill.

The protection field is defined by the height and width of the protection field. The protected height is the range between the first and last infrared light beam of a light curtain. The protected width or operating range is the distance between the emitter and receiver unit. If the light beam is interrupted, a signal is emitted to bring the dangerous movement of the machine to a standstill.

For the detection of body parts, a distinction is made between finger, hand and body protection. EN ISO 13855 sets the biometric data for finger protection to 14 mm, for hand detection to 30 mm, for leg detection up to 70 mm and for body detection to over 70 mm. Safety light grids are generally used to detect the penetration of the entire human body.

The safety light grids and light curtains can be smoothly connected through a M12 connector; they are equipped with a diagnostic interface as well as an LED for status indication. The safety light curtains or light grids feature an integrated safety-monitoring module with start/restart interlock and contactor control. Additional functions such as blanking, muting and a synchronisation function for the light curtains are also available. Today with Bluetooth® LE an innovative communication interface is available for the diagnosis and inspection of AOPD. The current AOPD data of the SLC440 and SLC440COM series are displayed in real time.



## SAFETY LIGHT CURTAINS WITH BLUETOOTH® INTERFACE BLE

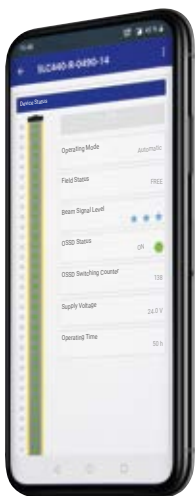

"SLC Assist" for iOS



"SLC Assist" for Android



### The App "SLC Assist"

The App gives information about

- Operating mode
- Beam signal level
- OSSD status
- Status of the protective field
- Number of OSSD switches
- Supply voltage
- Operating time

Beam signal level:

★★★ = perfect alignment

☆☆☆ = optimisation required

You will define the service cycles for the safety relay module via the OSSD switching counter. The information of the total operating time is the basis for planning the periodic inspection.

### Innovative Technology

The light curtain with Bluetooth® interface and the SCHMERSAL App gives optimal support for

- Condition monitoring
- Optimal alignment
- Preventive maintenance
- Documentation according to industrial safety regulations

The SCHMERSAL App "SLC Assist" is available for Android and iOS devices.

More information can be found in the product video.

Product video:



# OPTOELECTRONIC SAFETY DEVICES

## MODES OF OPERATION AND FUNCTIONS

### SAFETY LIGHT BARRIERS

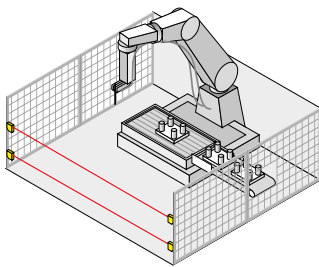

All SLB photoelectric barriers have fail-safe integrated semi-conductor outputs (2 x PNP) and can be incorporated directly in the safety circuit without external safety monitoring. The new product family meets the requirements of all type 2 or type 4 applications in accordance with EN 61496. The safety photoelectric barriers are distinguished by extremely small dimensions which means that they can be well placed in the surrounding structure and can also be mounted easily and quickly even in tight spaces. Both models have a range of 15 metres. The SLB 440...-H model features a range of up to 75 metres and, as an option, has integrated heating for use in minus temperatures.

Single beam photoelectric barriers are particularly suitable for safeguarding smaller hazardous areas – such as machines with small openings or slots.

With this set of features, the new photoelectric barriers can be deployed in numerous ways – for example in work areas where assembly and material handling technology is used as well as in the wood, paper and print industry. Other areas of application are (semi) automated shelving and commissioning systems, high shelf warehouses and packaging machines as well as for confining work areas of man and machine. It can also be used in outside areas, for example in the wood and cement industry, in gravel pits or in harbours/ports.

### OPERATING MODES



Double reset

The operating modes of an AOPD must be defined according to the risk analysis of a machine.

#### **Automatic / Protective mode**

The protective mode switches the AOPD outputs to an ON state (protection field not interrupted), without external release of a switching device. This mode of operation creates an automatic machine restart if the protection field is not interrupted and should only be selected with the restart interlock of the machine.

#### **Restart interlock (manual reset)**

The restart interlock (manual reset) prevents an automatic enabling of the outputs (OSSD's ON state) after switch-on of the operating voltage or an interruption of the protection field. The system switches the outputs only to an ON state, when an external command device generates an enabling signal at the restart input (receiver).

#### **Restart interlock with double acknowledgement/reset**

In applications with access monitoring, a complete overview of the hazardous areas is often not possible; despite that, a reset of the command device for the restart interlock outside of the hazardous area by third parties is enabled at all times. This hazardous situation of an unexpected start-up can be avoided by means of a double reset, i.e. integration of one command device inside and one outside the hazardous area.

#### **Setting mode**

Before commissioning an AOPD, the best possible alignment of the sensors should be determined. The set-up mode visualises the set-up quality during the installation of the sensors. Visualisation is via a 7-segment display, a status display or optionally via a smartphone with the "SLC Assist" app.



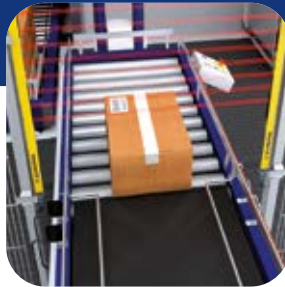

## OBJECT BLANKING

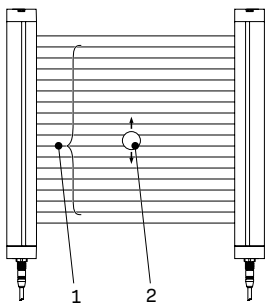

- 1 Object blanking area
- 2 Movable object

For safe production, object blanking can be used to blank just part of the protection field. This makes it possible to add objects, e.g. workpieces, or position a conveyor belt with a fixed position in the protection field.

With integrated movable object blanking (floating blanking) of the SLC440/445 light curtains, up to 2 light beams of the light curtain can be blanked flexibly. This function is required if there is a need to be able to interrupt light beams in the protection field at a position that is not specifically defined.

Different blanking functions are available. The distinguishing feature of the different modes is the number of light beams that can be interrupted by an object. In addition to that, it can be defined whether the object may be in the protection field permanently or only temporarily. The interrupted light beams can be at any position in the protection field.

## MUTING

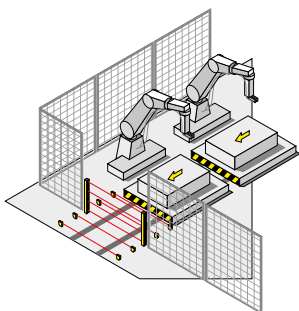

If goods or objects need to be transported in or out of the hazardous area without stopping the machine, the safety light curtain must be automatically and temporarily suspended. Two or four muting signals are used to detect whether a person is approaching the hazardous area or a transport system is entering or leaving the hazardous area. Suitable muting inputs are light barriers, proximity switches or position switches.

The integrated safety-muting controller of the safety light curtain or light grid monitors and controls the muting process. The safety outputs are not disabled. Depending on the application, different light barriers with integrated muting functions are available.

# OPTOELECTRONIC SAFETY DEVICES

## SAFETY DISTANCE

### SAFETY DISTANCE

The stopping time for the complete system and the resolution capacity of the AOPD essentially determines the required safety distance of the AOPD to the dangerous area. The safety light grid or light curtain must be sized and installed so that a stop signal would be transmitted and the hazard ceased prior to a person or a body part accessing the danger zone.

The standard ISO 13855 provides the user with detailed information about the calculation of the minimum safety distances. These include the following important influencing factors:

- Stopping time of the entire system, taking the different reaction times of the individual systems into account (e.g. machine, safety relay module, AOPD etc.)
- Detection capability of the AOPD to detect body parts (finger, hand and whole body)
- Arrangement of each protection device in the normal position (vertical mounting), parallel orientation (horizontal mounting) or at any angle in front of the guard system
- Approach speed to the protection field

For the calculation of the minimum safety distance  $S$  to the hazardous area, EN ISO 13855 presents the following general formula:

$$S = K \times T + C$$

Key:

**S** the safety distance to the hazardous area (mm)

**K** the approach speed of the body or the body part (mm/s)

**T** total reaction time of the system (s)  
(inc. machine run-on time, reaction time of the safety guard and the safety relay module, etc.)

**C** additional distance (mm) before the safety guard

If access to the hazardous area (by passing across the protection field) cannot be excluded by using vertically mounted contactless protective equipment such as a light grid, an additional minimum distance  $CRO$  should be considered.

This distance is dependent on the protection field height above the ground and the position of the hazardous area (EN ISO 13855).

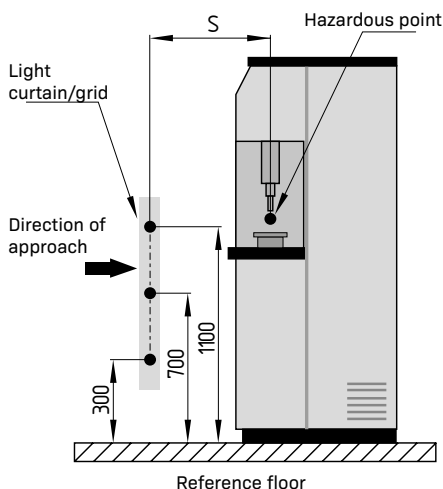

# OPTOELECTRONIC SAFETY DEVICES OVERVIEW

Selection	Type to EN 61496	Special features	Series	refer to
Safety light barriers SLB	Type 2	Range to 15 m	SLB240	Page 12
	Type 4	Range to 15 m	SLB440	
		Range to 75 m	SLB440-H	
Safety light curtains SLC	Type 2	Compact	SLC240COM	Page 14
	Type 4	Included in standard version	SLC420	Page 16
		Master / Slave	SLC420 M/S	
		Compact	SLC440COM	Page 20
		High degree of protection	SLC440COM – PH enclosure	
		Included in standard version	SLC440	
		High degree of protection	SLC440 – SH/PH enclosure	
		Multifunctional	SLC445	
Type 2	Compact	SLG240COM	Page 14	
Safety light grids SLG	Type 4	Included in standard version	SLG420	Page 16
		Active-passive system with mirror	SLG422-P	
		Compact	SLG440COM	Page 20
		High degree of protection	SLG440COM – PH enclosure	
		Included in standard version	SLG440	
		High degree of protection	SLG440 – SH/PH enclosure	
		Multifunctional	SLG445	

# SAFETY LIGHT BARRIERS

## RANGE SLB – OVERVIEW



### Key Features

- |   |   |  |
|---|---|--|
| <ul style="list-style-type: none"> <li>▪ Safety light barrier type 2</li> <li>▪ 4-stage coding</li> <li>▪ Integr. evaluation</li> </ul> | <ul style="list-style-type: none"> <li>▪ Safety light barrier type 4</li> <li>▪ 4-stage coding</li> <li>▪ Integr. evaluation</li> </ul> | <ul style="list-style-type: none"> <li>▪ Safety light barrier type 4</li> <li>▪ 4-stage coding</li> <li>▪ Integr. evaluation</li> <li>▪ optional heater</li> </ul> |
|---|---|--|

### Technical features

<b>Range of the protection field</b>	15 m	15 m	75 m
<b>Min. object size</b>	Ø 10 mm	Ø 10 mm	Ø 70 mm
<b>Wave length of the sensors</b>	880 nm	880 nm	880 nm
<b>Electrical characteristics</b>			
<b>Response time</b>	7 ... 22 ms	7 ... 22 ms	7 ... 22 ms
<b>Automatic/restart interlock</b>	■	■	■
<b>Rated operating voltage Ue</b>	24 VDC ± 10%	24 VDC ± 10%	24 VDC ± 10%
<b>Safety outputs</b>	2 x OSSD	2 x OSSD	2 x OSSD
<b>Mechanical data</b>			
<b>Material of the housings</b>	Aluminium	Aluminium	Aluminium
<b>Termination</b>	ST: Connector plug M12 LST: 20 cm Cable with connector M12	ST: Connector plug M12 LST: 20 cm Cable with connector M12	ST: Connector plug M12 LST: 20 cm Cable with connector M12
<b>Connector plug (transmitter/receiver)</b>	4-pole / 5-pole	4-pole / 5-pole	4-pole / 5-pole
<b>Cable length</b>	Max. 100 m	Max. 100 m	Max. 100 m
<b>Dimensions (H x W x L)</b>	ST: 28 x 91 x 33 mm LST: 28 x 72 x 33 mm	ST: 28 x 91 x 33 mm LST: 28 x 72 x 33 mm	ST: 28 x 131 x 33 mm LST: 28 x 111 x 33 mm
<b>Ambient conditions</b>			
<b>Ambient temperature</b>	-30 °C ... +50 °C	-30 °C ... +50 °C	-30 °C ... +50 °C
<b>Degree of protection</b>	IP67	IP67	IP67
<b>Recommended safety-monitoring module for the series wiring</b>	SRB-E-204ST	SRB-E-204ST	SRB-E-204ST

### Safety classification



<b>Standards</b>	EN ISO 13849-1 EN 62061	EN ISO 13849-1 EN 62061	EN ISO 13849-1 EN 62061
<b>PL/SIL</b>	c/2	e/3	e/3
<b>Control category</b>	2	4	4
<b>PFH</b>	$1.5 \times 10^{-8}$ /h	$1.5 \times 10^{-8}$ /h	$1.5 \times 10^{-8}$ /h
<b>Certificates</b>			





To get detailed information about the products and certificates, visit [products.schmersal.com](https://products.schmersal.com).



# SAFETY LIGHT BARRIERS

## RANGE SLB – PREFERRED TYPES AND ACCESSORIES

Type	Range	Type	Termination	Type	Material number	
Safety light barriers	SLB240		Coding 1*	Connector plug	SLB240-ER-1-ST	103013801
				Cable with connector	SLB240-ER-1-LST	103013529
	SLB440		Coding 1*	Connector plug	SLB440-ER-1-ST	103019521
				Cable with connector	SLB440-ER-1-LST	103013525
	SLB440-H		Coding 1*	Connector plug	SLB440-ER-1-ST-H	103015483
				Cable with connector	SLB440-ER-1-LST-H	103015487
				Connector plug	SLB440-ER-1-ST-H-EH	103015491
				Cable with connector	SLB440-ER-1-LST-H-EH	103015497

\*Other coding available.

Connector	KA-0977	103013625	MS-...
 <ul style="list-style-type: none"> <li>■ Connector M12, straight, 4 pole                             <ul style="list-style-type: none"> <li>5 m KA-0804</li> <li>10 m KA-0805</li> <li>20 m KA-0808</li> </ul> </li> <li>■ Connector M12, straight, 5 pole                             <ul style="list-style-type: none"> <li>5 m A-K5P-M12-S-G-5M-BK-2-X-A-1</li> <li>10 m A-K5P-M12-S-G-15M-BK-2-X-A-1</li> </ul> </li> </ul>	 <ul style="list-style-type: none"> <li>■ Parametrisation cable for SLB series</li> <li>■ Y-splitter, M12, 5-pole with P-button</li> </ul>	 <ul style="list-style-type: none"> <li>■ Assembly sets for SLB series                             <ul style="list-style-type: none"> <li>■ For SLB240 / SLB440 (qty. 2 brackets, qty. 4 screws) MS-1101</li> <li>■ For SLB440-H (qty. 4 brackets, qty. 8 screws) MS-1100</li> </ul> </li> </ul>	

SMA-80	101150262	BF-SMA-80-1	101150263	BF-SMA-80-2	101150264
 <ul style="list-style-type: none"> <li>■ Tilted mirror for SLB series                             <ul style="list-style-type: none"> <li>■ Height: 80 mm</li> <li>■ Width: 120 mm</li> </ul> </li> </ul>	 <ul style="list-style-type: none"> <li>■ Mounting bracket for attachment of tilted mirror SMA-80 (horizontal tilt)</li> </ul>	 <ul style="list-style-type: none"> <li>■ Mounting bracket for attachment of tilted mirror SMA-80 (vertical tilt)</li> </ul>			

Detailed information for the selection of accessories can be found at [products.schmersal.com](http://products.schmersal.com).

# SAFETY LIGHT GRIDS AND CURTAINS

## TYPE 2 – RANGE 240COM – OVERVIEW



■ SLC240COM



■ SLG240COM

### Key Features

- Safety light curtain
- Compact

- Safety light grid
- Compact

### Technical features

<b>Resolution</b>	14, 30, 35 mm	300, 400 or 500 mm
<b>Protection heights</b>	330 mm ... 1930 mm	500, 800 or 900 mm
<b>Number of Beams</b>	11 ... 192	2, 3 or 4 beams
<b>Range of the protection field</b>	0.3 ... 12 m	0,3 ... 12 m
<b>Operating modes</b>		
- Protective mode / Automatic	■	■
- Restart interlock (manual reset)	■	■
- Parameter setting	KA-0896	KA-0896
<b>Functions integrated</b>		
- Contactor control	-	-
- Blanking of objects	■	■
- Muting	-	-
- Cyclic function	-	-
- Further functions (see key)	DM, RS	DM, RS
<b>Electrical characteristics</b>		
<b>Operating voltage</b>	24 VDC ± 10%	24 VDC ± 10%
<b>Safety output OSSD, 24 VDC</b>	2 x PNP (timing)	2 x PNP (timing)
<b>Response time OSSD</b>	10 ... 28 ms	10 ms
<b>Switching capacity OSSD</b>	500 mA	500 mA
<b>LED status display, 7-segment display</b>	Status indicator	Status indicator
<b>Mechanical data</b>		
<b>Execution of the electrical connection</b>	Connector	Connector
<b>Connector plug (transmitter/receiver)</b>	4-pole / 5-pole	4-pole / 5-pole
<b>Dimensions <sup>1)</sup></b>	27.8 x 33 mm	27.8 x 33 mm
<b>Ambient conditions</b>		
<b>Ambient temperature</b>	-10 °C ... +50 °C	-10 °C ... +50 °C
<b>Degree of protection</b>	IP67	IP67

### Safety classification

<b>Standards</b>	EN ISO 13849-1, EN 62061	EN ISO 13849-1, EN 62061
<b>PL/SIL</b>	c/1	c/1
<b>Control category</b>	2	2
<b>PFH</b>	8.05 x 10 <sup>-9</sup> /h	8.05 x 10 <sup>-9</sup> /h
<b>Certificates</b>		



Type to EN 61496	Type	Range	Resolution	Protection heights	Range	Type	Material number
Type 2	Safety light curtain SLC	SLC240COM	14 mm	330 ... 1930 mm	0,3 ... 7 m	SLC240COM-ER-xxxx-14	---
			30 mm	330 ... 1930 mm	0,3 ... 12 m	SLC240COM-ER-xxxx-30	---
			35 mm	330 ... 1930 mm	0,3 ... 7 m	SLC240COM-ER-xxxx-35	---
	Safety light grids SLG	SLG240COM	2 beams	500 mm	0.3 ... 12 m	SLG240COM-ER-0500-02	103016120
			3 beams	800 mm	0.3 ... 12 m	SLG240COM-ER-0800-03	103016122
			4 beams	900 mm	0.3 ... 12 m	SLG240COM-ER-0900-04	103016127

xxxx = For different heights and other combinations, see [products.schmersal.com](https://products.schmersal.com).

--- = The material number is dependent on the protective field heights.

<sup>1)</sup> The height depends on the protection field height

#### Key

BC = Beam coding  
DQ = Double acknowledgement/reset  
MS = Multiple scan  
DM = Setting mode  
SI = Start interlock  
RS = Series-wiring

To get detailed information about the products and certificates, visit [products.schmersal.com](https://products.schmersal.com).

# SAFETY LIGHT GRIDS AND CURTAINS

## TYPE 4 – RANGE 420/422 – OVERVIEW



■ SLC420



■ SLC420 M/S

### Key Features



- Safety light curtain
- Standard

- Safety light curtain
- Master/Slave

### Technical features

<b>Resolution</b>	14, 30, 50 mm	14, 30, 50 mm
<b>Protection heights</b>	170 mm ... 1770 mm	170 mm ... 2420 mm
<b>Number of beams</b>	2 ... 144	4 ... 208
<b>Range of the protection field</b>	0.3 ... 18 m	0.3 ... 18 m
<b>Operating modes</b>		
- Protective mode / Automatic	■	■
- Restart interlock (manual reset)	■	■
- Parameter setting	NSR-0801 (adapter)	NSR-0801 (adapter)
<b>Functions integrated</b>		
- Contactor control	■	■
- Blanking of objects	■	■
- Muting	-	-
- Cyclic function	-	-
- Further functions (see key)	BC, SI	BC, SI
<b>Electrical characteristics</b>		
<b>Operating voltage</b>	24 VDC ± 10%	24 VDC ± 10%
<b>Safety output OSSD, 24 VDC</b>	2 x PNP	2 x PNP
<b>Response time OSSD</b>	10 ... 27 ms	10 ... 37 ms
<b>Switching capacity OSSD</b>	500 mA	500 mA
<b>LED status display, 7-segment display</b>	LED	LED
<b>Mechanical data</b>		
<b>Execution of the electrical connection</b>	Connector	Connector
<b>Connector plug (transmitter/receiver)</b>	4-pole / 8-pole	4-pole / 8-pole
<b>Dimensions <sup>1)</sup></b>	Ø 49 mm	Ø 49 mm
<b>Ambient conditions</b>		
<b>Ambient temperature</b>	-25 °C ... +50 °C	-10 °C ... +50 °C
<b>Degree of protection</b>	IP67	IP67

### Safety classification

<b>Standards</b>	EN ISO 13849-1, EN 62061	EN ISO 13849-1, EN 62061
<b>PL/SIL</b>	e/3	e/3
<b>Control category</b>	4	4
<b>PFH</b>	7.42 x 10 <sup>-9</sup> /h	7.42 x 10 <sup>-9</sup> /h
<b>Certificates</b>		



To get detailed information about the products and certificates, visit [products.schmersal.com](https://products.schmersal.com).





■ SLG420





■ SLG422-P

- Safety light grid
- Standard

- Safety light grid
- Active-passive with deflecting mirror ULS

300, 400 or 500 mm	300 mm
500, 800 or 900 mm	500 mm
2, 3 or 4 beams	2 beams
0.3 ... 50 m	0.3 ... 7 m
■	■
■	■
NSR-0801 (adapter)	NSR-0801 (adapter)
■	■
■	-
-	-
-	-
BC, SI	SI
24 VDC ± 10%	24 VDC ± 10%
2 x PNP	2 x PNP
10 ... 15 ms	10 ms
500 mA	500 mA
LED	LED
Connector	Connector
4-pole / 8-pole	8-pole
Ø 49 mm	Ø 49 mm
-25 °C ... +50 °C	-10 °C ... +50 °C
IP67	IP67

EN ISO 13849-1, EN 62061	EN ISO 13849-1, EN 62061
e/3	e/3
4	4
$7.42 \times 10^{-9} /h$	$7.42 \times 10^{-9} /h$
<b>TUV</b>  <b>ERC</b>	<b>TUV</b> 

<sup>1)</sup> The height depends on the protection field height

**Key**

- BC = Beam coding
- DQ = Double acknowledgement/reset
- MS = Multiple scan
- DM = Setting mode
- SI = Start interlock

# SAFETY LIGHT GRIDS AND CURTAINS

## TYPE 4 – RANGE 420/422 – PREFERRED TYPES

Type to EN 61496	Type	Feature	Series	Special features
Type 4	Safety light curtain SLC	Included in standard version	SLC420	Included in standard version
				High range
		Master / Slave	SLC420 M/S	Master
				Master + High range
	Safety light grids SLG	Included in standard version	SLG420	Slave
				Slave + High range
Active-passive with deflecting mirror ULS	Active-passive with deflecting mirror ULS	SLG422-P	Included in standard version	
			High range	
				Active-passive system

xxx = For different heights and other combinations, see [products.schmersal.com](http://products.schmersal.com).

--- = The material number is dependent on the protective field heights

	Resolution	Protection heights	Range	Type	Material number
	14 mm	170 ... 1450 mm	0.3 ... 7 m	<b>SLC420-ER-xxxx-14-RFB</b>	---
	30 mm	170 ... 1770 mm	0.3 ... 10 m	<b>SLC420-ER-xxxx-30-RFB</b>	---
	50 mm	170 ... 1770 mm	0.3 ... 10 m	<b>SLC420-ER-xxxx-50-RFB</b>	---
	30 mm	170 ... 1770 mm	0.3 ... 18 m	<b>SLC420-ER-xxxx-30-RFBH</b>	---
	14 mm	170 ... 2100 mm	0.3 ... 7 m	<b>SLC420-ER-xxxx-14-RFBM</b>	---
	30 mm	170 ... 2420 mm	0.3 ... 10 m	<b>SLC420-ER-xxxx-30-RFBM</b>	---
	50 mm	170 ... 2420 mm	0.3 ... 10 m	<b>SLC420-ER-xxxx-50-RFBM</b>	---
	30 mm	170 ... 2420 mm	0.3 ... 18 m	<b>SLC420-ER-xxxx-30-RFBMH</b>	---
	14 mm	170 ... 2100 mm	0.3 ... 7 m	<b>SLC420-ER-xxxx-14-RFBS</b>	---
	30 mm	170 ... 2420 mm	0.3 ... 10 m	<b>SLC420-ER-xxxx-30-RFBS</b>	---
	50 mm	170 ... 2420 mm	0.3 ... 10 m	<b>SLC420-ER-xxxx-50-RFBS</b>	---
	30 mm	170 ... 2420 mm	0.3 ... 18 m	<b>SLC420-ER-xxxx-30-RFBSH</b>	---
	2 beams	500 mm	0.3 ... 18 m	<b>SLG420-ER-0500-02-RF</b>	<b>101207359</b>
	3 beams	800 mm	0.3 ... 18 m	<b>SLG420-ER-0800-03-RF</b>	<b>101207360</b>
	4 beams	900 mm	0.3 ... 18 m	<b>SLG420-ER-0900-04-RF</b>	<b>101207361</b>
	2 beams	500 mm	8 ... 50 m	<b>SLG420-ER-0500-02-RFH</b>	<b>101207362</b>
	3 beams	800 mm	8 ... 50 m	<b>SLG420-ER-0800-03-RFH</b>	<b>101207363</b>
	4 beams	900 mm	8 ... 50 m	<b>SLG420-ER-0900-04-RFH</b>	<b>101207364</b>
	2 beams	500 mm	0.3 ... 7 m	<b>SLG422P-ER-0500-02-RF</b>	<b>101207547</b>

# SAFETY LIGHT GRIDS AND CURTAINS

## TYPE 4 – RANGE 440COM/440/445 – OVERVIEW



■ SLC440COM

■ SLC440

■ SLC445

### Key Features

- |  |   |   |
|--|---|---|
| <ul style="list-style-type: none"> <li>• Safety light curtain</li> <li>• Compact</li> <li>• Integrated Bluetooth LE interface</li> </ul> | <ul style="list-style-type: none"> <li>• Safety light curtain</li> <li>• Standard</li> <li>• Integrated Bluetooth LE interface</li> </ul> | <ul style="list-style-type: none"> <li>• Safety light curtain</li> <li>• Multifunctional</li> </ul> |
|--|---|---|

### Other versions

AS-i SaW

–

■ <sup>1)</sup>

–

### Technical features

<b>Resolution</b>	14, 30, 35 mm	14, 30 mm	14, 30 mm
<b>Protection heights</b>	330 mm ... 1930 mm	170 mm ... 1930 mm	170 mm ... 1770 mm
<b>Number of beams</b>	11 ... 192	8 ... 192	8 ... 144
<b>Range of the protection field</b>	0.3 ... 10 m	0.3 ... 20 m	0.3 ... 10 m
<b>Operating modes</b>			
- Protective mode / Automatic	■	■	■
- Restart interlock (manual reset)	■	■	■
- Parameter setting	Wiring	KA-0974	KA-0976
<b>Functions integrated</b>			
- Contactor control	–	■	■
- Blanking of objects	–	■	■
- Muting	–	–	■
- Cyclic function	–	–	■
- Further functions (see key)	DM	BC, DQ, DM	BC, DQ, MS, DM
<b>Electrical characteristics</b>			
<b>Operating voltage</b>	24 VDC ± 10%	24 VDC ± 10%	24 VDC ± 10%
<b>Safety output OSSD, 24 VDC</b>	2 x PNP (timing)	2 x PNP (timing)	2 x PNP (timing)
<b>Response time OSSD</b>	10 ... 28 ms	10 ... 28 ms	10 ... 27 ms
<b>Switching capacity OSSD</b>	500 mA	500 mA	500 mA
<b>LED status display, 7-segment display</b>	Status display	7-segment display	7-segment display
<b>Mechanical data</b>			
<b>Execution of the electrical connection</b>	Connector	Connector	Connector
<b>Connector plug (transmitter/receiver)</b>	4-pole / 5-pole	4-pole / 8-pole	4-pole / 12-pole
<b>Dimensions <sup>2)</sup></b>	27.8 x 33 mm	27.8 x 33 mm	27.8 x 33 mm
<b>Ambient conditions</b>			
<b>Ambient temperature</b>	–10 °C ... +50 °C	–25 °C ... +50 °C	–25 °C ... +50 °C
<b>Degree of protection</b>	IP67	IP67	IP67

### Safety classification

<b>Standards</b>	EN ISO 13849-1, EN 62061	EN ISO 13849-1, EN 62061	EN ISO 13849-1, EN 62061
<b>PL/SIL</b>	e/3	e/3	e/3
<b>Control category</b>	4	4	4
<b>PFH</b>	8.05 x 10 <sup>-9</sup> /h	5.14 x 10 <sup>-9</sup> /h	5.14 x 10 <sup>-9</sup> /h
<b>Certificates</b>			





■ SLG440COM



■ SLG440



■ SLG445



■ 440/COM IP69

- Safety light grid
- Compact
- Integrated Bluetooth LE interface

- Safety light grid
- Standard
- Integrated Bluetooth LE interface

- Safety light grid
- Multifunctional

- safety light curtain SLC/ light grid SLG
- Compact
- Integrated Bluetooth LE interface

–

■<sup>1)</sup>

–

–

300, 400 or 500 mm  
500, 800 or 900 mm  
2, 3 or 4 beams  
0,3 ... 12 m

300, 400 or 500 mm  
500, 800 or 900 mm  
2, 3 or 4 beams  
0.3 ... 20 m

300, 400 or 500 mm  
500, 800 or 900 mm  
2, 3 or 4 beams  
0.3 ... 20 m

14 ... 500 mm  
170 mm ... 1770 mm  
8 ... 192  
0.3 ... 20 m



Wiring



KA-0974



KA-0976



Wiring

–

■

–

■

–

■

■

■

–

–

■

–

DM

BC, DQ, DM

BC, DQ, MS, DM

BC, DQ, DM

24 VDC ± 10%  
2 x PNP (timing)  
10 ms  
500 mA

24 VDC ± 10%  
2 x PNP (timing)  
10 ... 15 ms  
500 mA

24 VDC ± 10%  
2 x PNP (timing)  
10 ... 15 ms  
500 mA

24 VDC ± 10%  
2 x PNP (timing)  
10 ... 28 ms  
500 mA

Status display

7-segment display

7-segment display

7-segment display

Connector

4-pole / 5-pole  
27.8 x 33 mm

Connector

4-pole / 8-pole  
27.8 x 33 mm

Connector

4-pole / 12-pole  
27.8 x 33 mm

Connector

4-pole / 8-pole  
Ø 50 mm

–10 °C ... +50 °C  
IP67

–25 °C ... +50 °C  
IP67

–25 °C ... +50 °C  
IP67

–10/–25 °C ... +50 °C  
IP69

EN ISO 13849-1,  
EN 62061

EN ISO 13849-1,  
EN 62061

EN ISO 13849-1,  
EN 62061

EN ISO 13849-1,  
EN 62061

e/3

e/3

e/3

e/3

4

4

4

4

8.05 x 10<sup>-9</sup> /h

5.14 x 10<sup>-9</sup> /h

5.14 x 10<sup>-9</sup> /h

5.14 x 10<sup>-9</sup> /h



<sup>1)</sup> SLC/SLG440-AS versions without BLE available with AS-i SaW interface

<sup>2)</sup> The height depends on the protection field height

<sup>3)</sup> Bluetooth LE is integrated from version 3.0 onwards

**Key**

BC = Beam coding

DQ = Double acknowledgement/reset

MS = Multiple scan

DM = Setting mode

SI = Start interlock

To get detailed information about the products and certificates, visit [products.schmersal.com](http://products.schmersal.com).

# SAFETY LIGHT GRIDS AND CURTAINS

## TYPE 4 – RANGE 440COM/440/445 – PREFERRED TYPES

Type to EN 61496	Safety	Feature	Series	Special features
Type 4	Light curtain SLC	Compact	SLC440COM	Compact High protection class / Compact + Protective enclosure
		Included in standard version	SLC440	Included in standard version
				Integrated status display
				High range and integrated status display
				High protection class / SLC440 + Protective enclosure
		AS-i	SLC440AS	Integrated AS-i SaW
		Multifunctional	SLC445	Muting cyclic operation with multiscan
		Light grids SLG	Compact	SLG440COM
	Included in standard version		SLG440	Included in standard version
				High range
				Integrated status display
				High range and integrated status display
	High protection class / SLG440 + Protective enclosure			
	AS-i	SLG440AS	Integrated AS-i SaW	
Multifunctional	SLG445	Muting cyclic operation with multiscan		

xxx = For different heights and other combinations, see [products.schmersal.com](http://products.schmersal.com).

--- = The material number is dependent on the protective field heights.

	Resolution	Protection heights	Range	Type	Material number
	14 mm	330 ... 1930 mm	0,3 ... 7 m	SLC440COM-ER-xxxx-14	---
	30 mm	330 ... 1930 mm	0.3 ... 10 m	SLC440COM-ER-xxxx-30	---
	35 mm	330 ... 1930 mm	0,3 ... 7 m	SLC440COM-ER-xxxx-35	---
e PH				SLC440COM-ER-xxxx-xx	---
	14 mm	170 ... 1930 mm	0,3 ... 7 m	SLC440-ER-xxxx-14	---
	30 mm	170 ... 1930 mm	0.3 ... 10 m	SLC440-ER-xxxx-30	---
	14 mm	170 ... 1930 mm	0,3 ... 7 m	SLC440-ER-xxxx-14-01	---
	30 mm	170 ... 1930 mm	0.3 ... 10 m	SLC440-ER-xxxx-30-01	---
	14 mm	170 ... 1930 mm	3 ... 10 m	SLC440-ER-xxxx-14-H1	---
	30 mm	170 ... 1930 mm	4 ... 20 m	SLC440-ER-xxxx-30-H1	---
PH/SH				SLC440-ER-xxxx-xx-01	---
	14 mm	170 ... 1450 mm	0,3 ... 7 m	SLC440AS-ER-xxxx-14	---
	30 mm	170 ... 1770 mm	0.3 ... 10 m	SLC440AS-ER-xxxx-30	---
	14 mm	170 ... 1450 mm	0,3 ... 7 m	SLC445-ER-xxxx-14-01	---
	30 mm	170 ... 1770 mm	0.3 ... 10 m	SLC445-ER-xxxx-30-01	---
	2 beams	500 mm	0.3 ... 12 m	SLG440COM-ER-0500-02	103004060
	3 beams	800 mm	0.3 ... 12 m	SLG440COM-ER-0800-03	103004063
	4 beams	900 mm	0.3 ... 12 m	SLG440COM-ER-0900-04	103004064
e PH				SLG440COM-ER-xxxx-xx	---
	2 beams	500 mm	0,3 ... 12 m	SLG440-ER-0500-02	101216818
	3 beams	800 mm	0,3 ... 12 m	SLG440-ER-0800-03	101216819
	4 beams	900 mm	0,3 ... 12 m	SLG440-ER-0900-04	101216820
	2 beams	500 mm	4 ... 20 m	SLG440-ER-0500-02-H	103009186
	3 beams	800 mm	4 ... 20 m	SLG440-ER-0800-03-H	103009187
	4 beams	900 mm	4 ... 20 m	SLG440-ER-0900-04-H	103009188
	2 beams	500 mm	0,3 ... 12 m	SLG440-ER-0500-02-01	101216821
	3 beams	800 mm	0,3 ... 12 m	SLG440-ER-0800-03-01	101216822
	4 beams	900 mm	0,3 ... 12 m	SLG440-ER-0900-04-01	101216823
	2 beams	500 mm	4 ... 20 m	SLG440-ER-0500-02-H1	103009189
	3 beams	800 mm	4 ... 20 m	SLG440-ER-0800-03-H1	103009190
	4 beams	900 mm	4 ... 20 m	SLG440-ER-0900-04-H1	103009191
PH/SH				SLG440-ER-xxxx-xx-01	---
	2 beams	500 mm	0,3 ... 12 m	SLG440AS-ER-0500-02	103007551
	3 beams	800 mm	0,3 ... 12 m	SLG440AS-ER-0800-03	103007554
	4 beams	900 mm	0,3 ... 12 m	SLG440AS-ER-0900-04	103007557
	2 beams	500 mm	0,3 ... 12 m	SLG445-ER-0500-02-01	103005424
	3 beams	800 mm	0,3 ... 12 m	SLG445-ER-0800-03-01	103005425
	4 beams	900 mm	0,3 ... 12 m	SLG445-ER-0900-04-01	103005426
	2 beams	500 mm	3 ... 20 m	SLG445-ER-0500-02-H1	103006524
	3 beams	800 mm	3 ... 20 m	SLG445-ER-0800-03-H1	103006527
	4 beams	900 mm	3 ... 20 m	SLG445-ER-0900-04-H1	103006530

# SAFETY LIGHT GRIDS AND CURTAINS EVALUATION UNITS



■ SRB-E-301MC



■ SRB-E-301ST

## Key Features

- Function STOP 0
- 1- or 2-channel control
- Start button / autostart
- 3 safety contacts
- 1 auxiliary contact

- Function STOP 0
- 1- or 2-channel control
- Monitored start button / autostart
- 3 safety contacts
- 1 auxiliary contact

## Technical features

Electrical characteristics		
Operating voltage	24 VAC / VDC -20 % / +20 %	24 VAC / VDC -20 % / +20 %
Operating current	0.1 A	0.1 A
Max. switching capacity of the safety contacts	3 x 230 V / 6 A	3 x 230 V / 6 A
of the safe semi-conductor outputs	-	-
of the auxiliary contacts	1 x 24 VDC / 1 A	1 x 24 VDC / 1 A
of the signalling outputs	-	-
Drop-out delay STOP 0	< 10 ms	< 10 ms
STOP 1	-	-
Mechanical data		
With removable terminals	■	■
Dimensions (H x W x D)	22.5 x 98 x 115 mm	22.5 x 98 x 115 mm
Environmental conditions		
Ambient temperature	-25 °C ... +60 °C	-25 °C ... +60 °C

## Safety classification

Standards	EN ISO 13849-1, IEC 61508	EN ISO 13849-1, IEC 61508
PL/SIL	e/3	e/3
Control category	4	4
PFH	< 6 x 10 <sup>-9</sup> /h	< 1.25 x 10 <sup>-8</sup> /h
Certificates	TÜV, cULus, CCC, EAC	TÜV, cULus, CCC, EAC



To get detailed information about the products and certificates, visit [products.schmersal.com](https://products.schmersal.com).





■ SRB-E-204ST



■ SRB202MSL

- Input expander module
- Monitoring of 4 sensors
- Start button / autostart
- 2 safety outputs
- 4 signalling outputs

- Muting function
- 2 or 4 muting sensors
- Lamp current monitoring
- 2 safety contacts
- 2 signalling outputs

24 VDC -20 % / +20 % 0.125 A	24 VDC -15% / +20% 0.24 A
-	2 x 24 VDC / 4 A
2 x 24 V / 2 A	-
-	-
4 x 24 V / 100 mA < 10 ms	24 VDC / 0.05 A < 20 ms
-	-
■	■
22.5 x 98 x 115 mm	45 x 100 x 121 mm
-25 °C ... +60 °C	-25 °C ... +45 °C

EN ISO 13849-1, IEC 61508 e/3 4 < 2.66 x 10 <sup>-9</sup> /h TÜV, cULus, CCC, EAC	EN ISO 13849-1, IEC 61508 e/3 4 < 2.0 x 10 <sup>-8</sup> /h cULus, EAC
---	--

# SAFETY LIGHT GRIDS AND CURTAINS

## ACCESSORIES

<p><b>Protective enclosure SG5/SG6</b></p>  <ul style="list-style-type: none"> <li>Protective enclosure for SLC/SLG</li> <li>Protection field heights to 970 mm: <b>SG5</b></li> <li>to 1930 mm: <b>SG6</b></li> </ul> <p><b>103001594</b> <b>103001596</b></p>	<p><b>Protective cover SGS5/SGS6</b></p>  <ul style="list-style-type: none"> <li>Protective Cover for SG5 and SG6</li> <li>Protection field heights to 970 mm: <b>SGS5</b></li> <li>to 1930 mm: <b>SGS6</b></li> </ul> <p><b>103001595</b> <b>103001597</b></p>	<p><b>Tilted mirror for SG5/SG6</b></p>  <ul style="list-style-type: none"> <li>Tilted mirror for SG5 and SG6</li> <li>1000 mm: <b>ULS-SG-1000</b></li> <li>1870 mm: <b>ULS-SG-1870</b></li> </ul> <p><b>103002489</b> <b>103016046</b></p>
<p><b>Mounting post MST</b></p>  <ul style="list-style-type: none"> <li>Mounting stands</li> <li>Base L/W 135x135 mm</li> <li>Height 500 ... 2000 mm</li> </ul>	<p><b>Deflecting mirror ULS-M</b></p>  <ul style="list-style-type: none"> <li>Deflecting mirror series M</li> <li>Mirror height 350 ... 1870 mm</li> <li>Included in delivery: tilted mirror and qty. 2 mounting brackets</li> </ul>	<p><b>Aligning aid EA5</b></p>  <ul style="list-style-type: none"> <li>Alignment kit, laser beam 30 m</li> <li>Alignment kit for all SLC/SLG series</li> </ul> <p><b>EA5</b> <b>101211456</b></p>
<p><b>Parametrisation cable KA-0974</b></p>  <ul style="list-style-type: none"> <li>Parametrisation cable for SLC/SLG <b>440</b></li> <li>Y-splitter, M12, 8-pole with P-button</li> </ul> <p><b>KA-0974</b> <b>101217615</b></p>	<p><b>Parametrisation cable KA-0896</b></p>  <ul style="list-style-type: none"> <li>Parametrisation cable for SLC/SLG <b>440COM</b> + SLC/SLG <b>240COM</b></li> <li>Y-splitter M12, 5-pole with command device</li> </ul> <p><b>KA-0896</b> <b>101030161</b></p>	<p><b>Parametrisation cable KA-0975</b></p>  <ul style="list-style-type: none"> <li>Parametrisation cable for SLC/SLG <b>440-AS</b></li> <li>Y-splitter M12, 8-pole with command device</li> </ul> <p><b>KA-0896</b> <b>103005659</b></p>

Detailed information can be found at [products.schmersal.com](https://products.schmersal.com).









# SAFETY LIGHT GRIDS AND CURTAINS ACCESSORIES

Connector	Connector	Connector
 <ul style="list-style-type: none"> <li>■ Connector M12, straight</li> <li>■ Cable length <b>4-pole</b>    <b>8-pole</b></li> <li>5 m            <b>KA-0804</b>    <b>KA-0904</b></li> <li>10 m          <b>KA-0805</b>    <b>KA-0905</b></li> <li>20 m          <b>KA-0808</b>    <b>KA-0908</b></li> </ul>	 <ul style="list-style-type: none"> <li>■ Connector M12, straight, <b>5 pole</b></li> <li>■ Cable length</li> <li>5 m            <b>A-K5P-M12-S-G-5M-BK-2-X-A-4-69</b></li> <li>10 m          <b>A-K5P-M12-S-G-10M-BK-2-X-A-4-69</b></li> <li>15 m          <b>A-K5P-M12-S-G-15M-BK-2-X-A-4-69</b></li> </ul>	 <ul style="list-style-type: none"> <li>■ Connector M12, straight, <b>12 pole</b></li> <li>■ Cable length</li> <li>5 m            <b>KA-0980</b>    <b>101213352</b></li> <li>10 m          <b>KA-0981</b>    <b>101213353</b></li> </ul>
Protective enclosure SH – stainless steel (440)	Protective enclosure PH – polyamide (440)	Protective enclosure PH – polyamide (440COM)
 <ul style="list-style-type: none"> <li>■ Protective enclosure IP69</li> <li>to 490 mm:    <b>SH-440-ER-01</b>    <b>103026832</b></li> <li>to 890 mm:    <b>SH-440-ER-02</b>    <b>103026833</b></li> <li>to 1290 mm:   <b>SH-440-ER-03</b>   <b>103026834</b></li> <li>to 1770 mm:   <b>SH-440-ER-04</b>   <b>103026835</b></li> </ul>	 <ul style="list-style-type: none"> <li>■ Protective enclosure IP69</li> <li>to 490 mm:    <b>PH-440-ER-01</b>    <b>103026836</b></li> <li>to 890 mm:    <b>PH-440-ER-02</b>    <b>103026837</b></li> <li>to 1290 mm:   <b>PH-440-ER-03</b>   <b>103026838</b></li> <li>to 1770 mm:   <b>PH-440-ER-04</b>   <b>103026839</b></li> </ul>	 <ul style="list-style-type: none"> <li>■ Protective enclosure IP69</li> <li>to 490 mm:    <b>PH-COM4-ER-01</b>   <b>103026840</b></li> <li>to 890 mm:    <b>PH-COM4-ER-02</b>   <b>103026841</b></li> <li>to 1290 mm:   <b>PH-COM4-ER-03</b>   <b>103026843</b></li> <li>to 1770 mm:   <b>PH-COM4-ER-04</b>   <b>103026844</b></li> </ul>
Protective enclosure PT with IP67 protection	Test rod PLS-01/-02	Vibration damper MSD4
 <ul style="list-style-type: none"> <li>■ Protective enclosure PT with IP67 protection for SLC440 170 ... 1770 mm: <b>PT-440-ER-xxxx</b></li> <li>■ Protective enclosure without IP69 protection for SLC440COM 330 ... 1770 mm: <b>PT-COM4-ER-xxxx</b></li> </ul>	 <ul style="list-style-type: none"> <li>■ Test rod</li> <li>30 mm diameter: <b>PLS-01</b>            <b>101207768</b></li> <li>14 mm diameter: <b>PLS-02</b>            <b>101207769</b></li> </ul>	 <ul style="list-style-type: none"> <li>■ Vibration damper</li> <li>■ Included in delivery: Set with 8 pieces SLC/SLG Type 4: <b>MSD4</b>            <b>101207754</b></li> </ul>

Detailed information can be found at [products.schmersal.com](http://products.schmersal.com).

# SAFETY LIGHT GRIDS AND CURTAINS

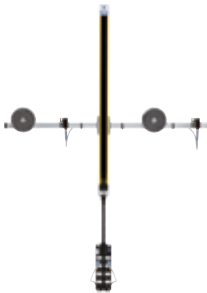
## ACCESSORIES – MUTING

<p><b>MCU-02</b> 103005572</p>  <ul style="list-style-type: none"> <li>■ Muting connection unit</li> <li>■ Release/override, transmitter unit (E), up to 4 muting sensors, muting lamp</li> </ul>	<p><b>S100-PR</b> 103040805</p>  <ul style="list-style-type: none"> <li>■ Muting sensor M8, 4-pole</li> <li>■ Reflection light barrier</li> <li>■ Range 0.1 ... 6.0 m</li> <li>■ Mounting brackets not included in the delivery</li> </ul>	<p><b>KA-0976</b> 103005575</p>  <ul style="list-style-type: none"> <li>■ Programming cable for SLC/SLG445</li> <li>■ P-button with connector M12, 12-pole</li> </ul>
<p><b>MUT-SET-L-01</b> 103006073</p>  <ul style="list-style-type: none"> <li>■ Muting set T-version for mounting to the assembly stand MST</li> <li>■ Set complete with 2 muting sensors, MCU-02, attachment and cable</li> <li>■ Set without SLC/SLG445 and MST</li> </ul>	<p><b>MUT-SET-L-02</b> 103006074</p>  <ul style="list-style-type: none"> <li>■ Muting set L-version for mounting to the sensor profile</li> <li>■ Set complete with 2 muting sensors, MCU-02, attachment and cable</li> <li>■ Set without SLC/SLG445 and MST</li> </ul>	<p><b>MUT-SET-T-01</b> 103006075</p>  <ul style="list-style-type: none"> <li>■ Muting set T-version for mounting to the assembly stand MST</li> <li>■ Set complete with 4 muting sensors, MCU-02, attachment and cable</li> <li>■ Set without SLC/SLG445 and MST</li> </ul>
<p><b>MUT-SET-T-02</b> 103006076</p>  <ul style="list-style-type: none"> <li>■ Muting set T-version for mounting to the sensor profile</li> <li>■ Set complete with 4 muting sensors, MCU-02, attachment and cable</li> <li>■ Set without SLC/SLG445 and MST</li> </ul>	<p><b>MUT-SET-T-03</b> 103009195</p>  <ul style="list-style-type: none"> <li>■ Muting set T-version for mounting to the sensor profile</li> <li>■ Set complete with 2 muting sensors, MCU-02, attachment and cable</li> <li>■ Set without SLC/SLG445 and MST</li> </ul>	<p><b>MUT-SET-T-04</b> 103012263</p>  <ul style="list-style-type: none"> <li>■ Muting set T-version for mounting to the assembly stand MST</li> <li>■ Set complete with 2 muting sensors, MCU-02, attachment and cable</li> <li>■ Set without SLC/SLG445 and MST</li> </ul>

Detailed information can be found at [products.schmersal.com](http://products.schmersal.com).

## SAFETY LIGHT GRIDS AND CURTAINS ACCESSORIES – MOUNTING KITS

MS-1030	101207756	MS-1038	101207757	MS-1051	101207758
 <ul style="list-style-type: none"> <li>■ Mounting kit for SLC/SLG420</li> <li>■ Included in delivery: Angle with screws</li> <li>■ Set with 4 pieces</li> </ul>	 <ul style="list-style-type: none"> <li>■ Mounting kit for SLC/SLG420 IP69 and SLC/SLG425I IP69 in V4A</li> <li>■ Included in delivery: Angle with screws</li> <li>■ Set with 4 pieces</li> </ul>	 <ul style="list-style-type: none"> <li>■ Mounting kit lateral fixation for SLC/SLG420-425I</li> <li>■ Included in delivery: qty. 2 steel brackets, qty. 4 screws and qty. 4 T-slot nuts</li> </ul>			
 <ul style="list-style-type: none"> <li>■ Mounting kit for deflecting mirror ULS-A4</li> <li>■ Included in delivery: Angle with screws</li> <li>■ Set with 2 pieces</li> </ul>	 <ul style="list-style-type: none"> <li>■ Mounting kit for deflecting mirror ULS-M</li> <li>■ Set with 2 pieces</li> </ul>	 <ul style="list-style-type: none"> <li>■ Mounting kit for SLC/SLG440COM, SLC/SLG440 and SLC/SLG445</li> <li>■ Included in delivery: Angle with screws</li> <li>■ Set with 4 pieces</li> </ul>			
 <ul style="list-style-type: none"> <li>■ Mounting kit - Centre fixing for SLC/SLG440COM, SLC/SLG440 and SLC/SLG445</li> <li>■ Set with 2 pieces</li> </ul>					



# tec.nicum

excellence in safety

## **tec.nicum – Developed services relating to the machine safety and industrial safety**

In the Schmersal Group, tec.nicum is the department for services relating to machine and industrial safety. The experts at tec.nicum implement all manner of safety-related projects for their customers – from analysis of the status quo through planning and documentation to the final handover of the finished, standard-compliant machine.

tec.nicum offers companies a global network of TÜV Rheinland-certified Functional Safety Engineers, so that the services of the international tec.nicum organisation can be accessed quickly and easily wherever the customer is located. tec.nicum experts not only have a sound knowledge of the applicable regional and national guidelines, laws and ordinances, they also have the technical know-how and extensive experience in project implementation.

The experts at tec.nicum aim to offer customers competent, product and manufacturer-neutral advice and support them in analysing and designing their machines and workplaces to comply with the standards.

For all of its consultancy and solution strategies, tec.nicum sets great store by objectivity.

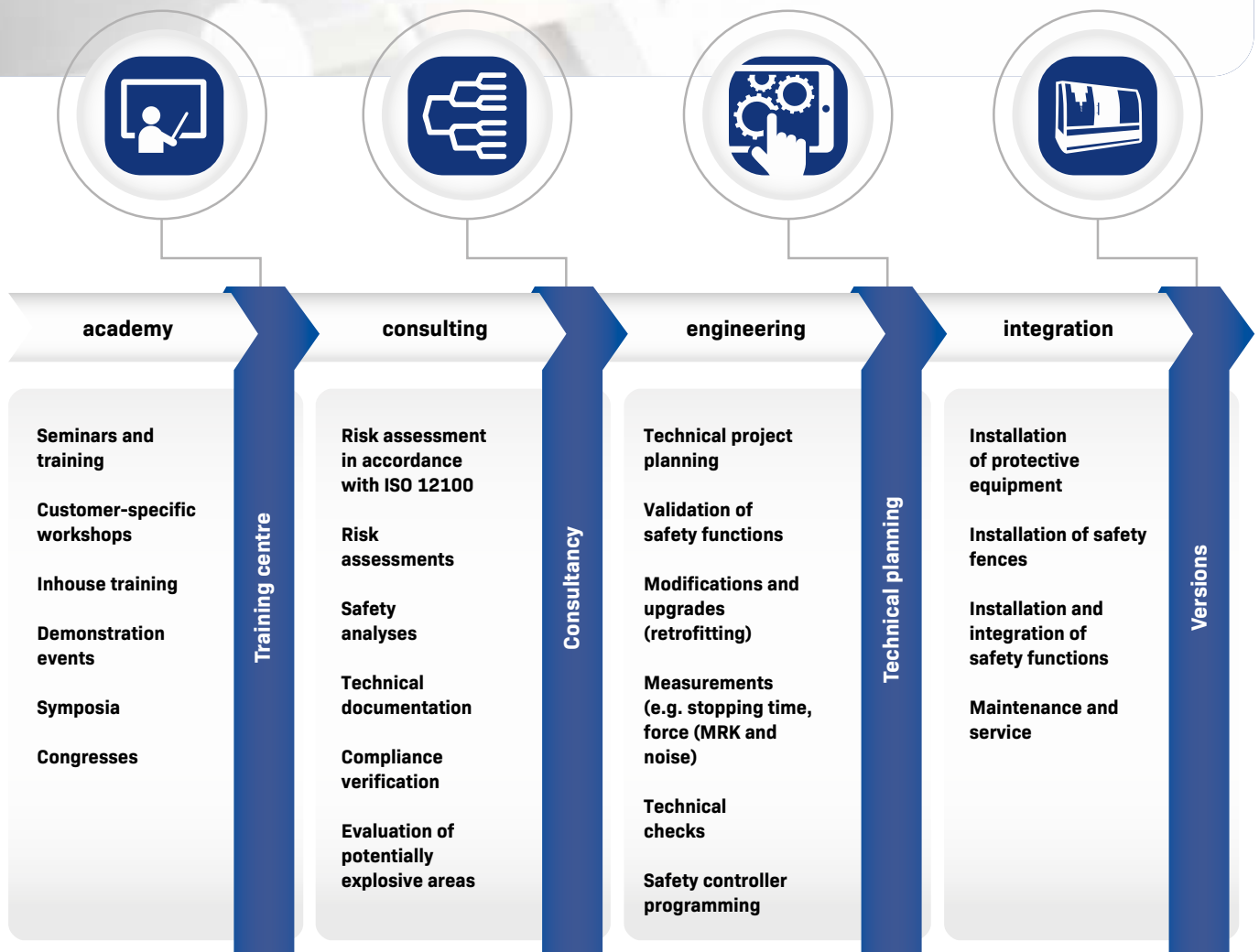

The range at tec.nicum covers four columns: learning in the **academy** section, consultancy services in the **consulting** section, designing safety solutions in the **engineering** section and practical implementation in the **integration** section.

The head office of the tec.nicum organisation, which operates all over the world, is in Wuppertal, Germany.

Contact:

**tec.nicum**

**K.A. Schmersal GmbH & Co. KG**

Möddinghofe 30

42279 Wuppertal

Phone: +49 202 6474-932

Telefax: +49 202 6474-100

E-Mail: [info-de@tecnicum.com](mailto:info-de@tecnicum.com)

[www.tecnicum.com](http://www.tecnicum.com)

 **SCHMERSAL**



# THE SCHMERSAL GROUP

## PROTECTION FOR MAN AND MACHINE

In the demanding field of machine safety, the owner-managed Schmersal Group is one of the international market leaders. The company, which was founded in 1945, has a workforce of about 2000 people and seven manufacturing sites on three continents along with its own companies and sales partners in more than 60 countries.

Customers of the Schmersal Group include global players from the area of mechanical engineering and plant manufacturing as well as operators of machinery. They profit from the company's extensive expertise as a provider of systems and solutions for machine safety. Furthermore, Schmersal specialises in various areas including food & beverage, packaging, machine tools, lift switchgear, heavy industry and automotive.

A major contribution to the systems and solutions offered by the Schmersal Group is made by tec.nicum with its comprehensive range of services: certified Functional Safety Engineers advise machinery manufacturers and machinery operators in all aspects relating to machinery and occupational safety – and do so with product and manufacturer neutrality. Furthermore, they design and realise complex solutions for safety around the world in close collaboration with the clients.



### SAFETY PRODUCTS

- Safety switches and sensors, solenoid interlocks
- Safety controllers and safety relay modules, safety bus systems
- Optoelectronic and tactile safety devices
- Automation technology: position switches, proximity switches

### SAFETY SYSTEMS

- Complete solutions for safeguarding hazard areas
- Individual parametrisation and programming of safety controllers
- Tailor-made safety technology – be it for individual machines or a complex production line
- Industry-specific safety solutions

### SAFETY SERVICES

- tec.nicum academy – Seminars and training
- tec.nicum consulting – Consultancy services
- tec.nicum engineering – Design and technical planning
- tec.nicum integration – Execution and installation



1.000 / L+W / 09.2021 / Teile-Nr. 101186592 / EN / Ausgabe 13



**SCHMERSAL**  
THE DNA OF SAFETY

The details and data referred to have been carefully checked.  
Subject to technical amendments and errors.

[www.schmersal.com](http://www.schmersal.com)