

Datasheet - BNS 33-11ZG

Safety sensors / BNS 33



Preferred typ



(Minor differences between the printed image and the original product may exist!)

- LED version
- Thermoplastic enclosure
- Concealed mounting possible
- Insensitive to transverse misalignment
- 88 mm x 25 mm x 13 mm
- Long life
- no mechanical wear
- Insensitive to soiling
- AS-Interface Safety at Work available

Ordering details

Product type description	BNS 33-11ZG
Article number	101109210
EAN Code	4030661026480
eCl@ss	27-27-24-02

Approval

Approval

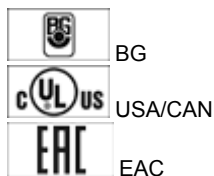

Classification

Standards	EN ISO 13849-1
B10d Normally-closed contact/Normally open contact (NC/NO)	25.000.000
- notice	at max. 20% contact load
Mission time	20 Years
notice	$MTTF_d = \frac{B_{10d}}{0,1 \times n_{op}}$ $n_{op} = \frac{d_{ap} \times h_{op} \times 3600 \text{ s/h}}{t_{cycle}}$

Global Properties

Permanent light	BNS 33
Standards	IEC 60947-5-3, BG-GS-ET-14
Compliance with the Directives (Y/N)	Yes
Materials	
- Material of the housings	Plastic, glass-fibre reinforced thermoplastic
- Material of the cable mantle	PVC
Weight	65
Monitoring function of downstream devices (Y/N)	No

Prerequisite evaluation unit	Yes
Recommended safety-monitoring module	
Recommended actuator	BPS 33, BPS 33-2326

Mechanical data

Design of electrical connection	Cable
Cable length	1
Conductors	0,25
AWG-Number	23
mechanical installation conditions	not flush
Active area	Side
Ensured switch distance ON S_{ao}	5 mm / 8 mm
- BPS 33 = 5 mm Actuating magnet	
- BPS 33-2326 = 8 mm Actuating magnet	
Ensured switch distance OFF S_{ar}	15 mm / 18 mm
- BPS 33-2326 = 18 mm Actuating magnet	
- BPS 33 = 15 mm Actuating magnet	
Repeat accuracy R_R	$\leq 0,1 \times S_{ao}$
Type of actuation	Magnet
Direction of motion	head-on with regard to the active surface
resistance to shock	30 g / 11 ms
Resistance to vibration	10 ... 55 HZ, Amplitude 1 mm

Ambient conditions

Ambient temperature	
- Min. environmental temperature	-25 °C
- Max. environmental temperature	+70 °C
Storage and transport temperature	
- Min. Storage and transport temperature	-25 °C
- Max. Storage and transport temperature	+70 °C
Protection class	IP67

Electrical data

Integrated Safety monitoring module available (Y/N)	No
Cross circuit/short circuit recognition possible (Y/N)	Yes
Voltage type	VDC
Switch frequency	max. 5 HZ
Switching voltage	max. 24 VDC
Switching current	max. 10 mA
Switching capacity	max. 240 mW

Outputs

Design of control output	Other, Reed kontakts
Number of shutters	1
Number of openers	1

Electrical data - Safety outputs

Number of secure semi-conductor outputs	0
---	---

Number of secure outputs with contact 0

Electrical data - Diagnostic output

Number of semi-conductor outputs with signaling function 0

Number of outputs with signaling function that already have a contact 0

LED switching conditions display

LED switching conditions display (Y/N) Yes

- The LED is illuminated when the guard door is open.

ATEX

Explosion protection categories for gases None

Explosion protected category for dusts None

Dimensions

Dimensions of the sensor

- Width of sensor 88 mm

- Height of sensor 25 mm

- Length of sensor 13 mm

notice

Contact symbols shown for the closed condition of the guard device.

The contact configuration for versions with or without LED is identical.

Included in delivery

Actuators must be ordered separately.

Diagram

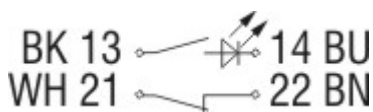



Note Diagram

 positive break NC contact

 active

 no active

 Normally-open contact

 Normally-closed contact

Ordering code

BNS 33-(1)Z(2)-(3)-(4)

(1)

02 2 Opener (NC)

11 1 Normally open contact (NO) / 1 Opener (NC)

12 1 Normally open contact (NO) / 2 Opener (NC)

(2)		
<i>without</i>		without LED switching conditions display
G		with LED switching conditions display
(3)		
<i>without</i>		with cable
ST		with connector M8
(4)		
2187		Individual contact outlet
2187-10		Individual contact outlet, with LED
2237		Actuation from cable direction

Documents

Operating instructions and Declaration of conformity (jp) 551 kB, 18.08.2017

Code: mrl_bns33_jp

Operating instructions and Declaration of conformity (es) 298 kB, 16.09.2016

Code: mrl_bns33_es

Operating instructions and Declaration of conformity (pt) 300 kB, 03.06.2016

Code: mrl_bns33_pt

Operating instructions and Declaration of conformity (en) 299 kB, 04.03.2016

Code: mrl_bns33_en

Operating instructions and Declaration of conformity (fr) 299 kB, 29.04.2016

Code: mrl_bns33_fr

Operating instructions and Declaration of conformity (pl) 327 kB, 29.04.2016

Code: mrl_bns33_pl

Operating instructions and Declaration of conformity (de) 300 kB, 04.03.2016

Code: mrl_bns33_de

Operating instructions and Declaration of conformity (cs) 307 kB, 08.01.2013

Code: mrl_bns33_cs

Operating instructions and Declaration of conformity (nl) 322 kB, 28.06.2018

Code: mrl_bns33_nl

Operating instructions and Declaration of conformity (da) 282 kB, 08.01.2013

Code: mrl_bns33_da

Operating instructions and Declaration of conformity (sv) 279 kB, 09.01.2013

Code: mrl_bns33_sv

Operating instructions and Declaration of conformity (it) 294 kB, 02.09.2016

Code: mrl_bns33_it

EAC certification (ru) 782 kB, 05.10.2015

Code: q_6044p17_ru

Images

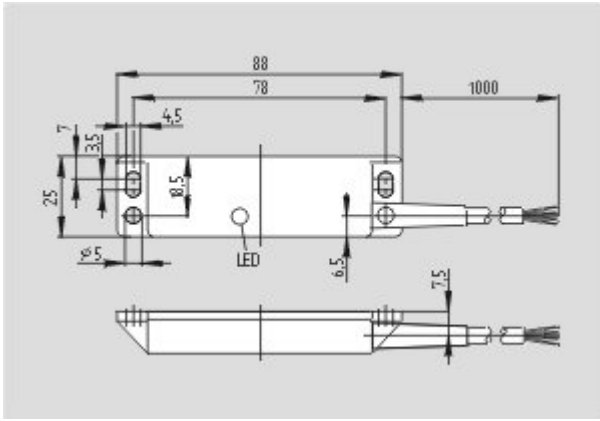

Dimensional drawing (basic component)

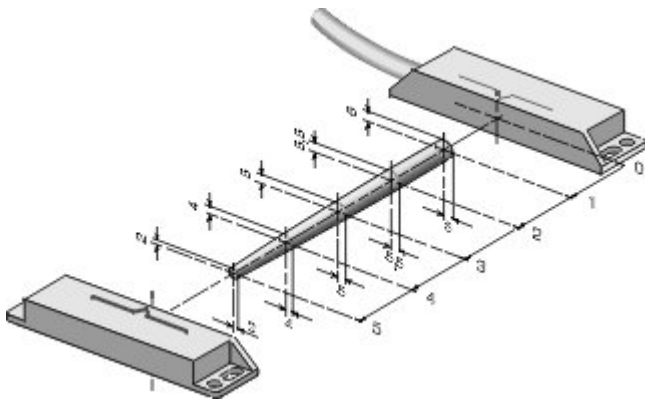

Characteristic curve

System components

Actuator

101107771 - BPS 33



101148482 - BPS 33-2326

- higher switching distance S_{ao} 8 mm



Accessories

101158893 - SPACER BN 31/33

- to mount the magnetic safety sensor and actuator on ferromagnetic material

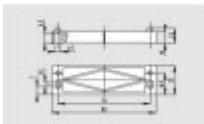

The data and values have been checked thoroughly. Technical modifications and errors excepted.
Generiert am 30.07.2019 - 23:20:41h Kasbase 3.3.0.F.64I