

## Datasheet - MZM 100 ST2-1P2PWREM-A

Solenoid interlock / MZM 100

 Preferred typ

- Guard locking monitored
- Automatic latching
- Solenoid interlocks (for the protection of man) with innovating and unique operating principle
- 40 mm x 179 mm x 40 mm
- Electronic contact-free, coded system
- Thermoplastic enclosure
- Max. length of the sensor chain 200 m
- 3 LEDs to show operating conditions
- Sensor technology permits an offset between actuator and interlock of  $\pm 5$  mm vertically and  $\pm 3$  mm horizontally
- Intelligent diagnosis
- Self-monitoring series-wiring of 31 sensors
- Patented
- Connector M12, 8-pole
- Power to lock

(Minor differences between the printed image and the original product may exist!)

### Ordering details

Product type description	MZM 100 ST2-1P2PWREM-A
Article number	101211067
EAN Code	4030661389134
eCl@ss	27-27-26-03

### Approval

Approval



### Classification

Standards	EN ISO 13849-1, IEC 61508, IEC 60947-5-3, EN 60947-5-1
PL	e
Control category	up 4
PFH	$3.5 \times 10^{-9}/h$
SIL	up 3
Mission time	20 Years
Classification	PDF-M

### Global Properties

Permanent light	MZM 100
Standards	IEC 61508, EN ISO 13849-1, EN ISO 13849-1
Compliance with the Directives (Y/N) 	Yes
Suitable for safety functions (Y/N)	Yes
Protection rating	III
Series-wiring	up to 31 components
Length of the sensor chain	max. 200 m
- without detriment to the category to EN ISO 13849-1	
Active principle	inductive
Duty cycle ED	100 %
Coding	Universal coding
	low
Duty cycle ED	100 %
Materials	
- Material of the housings	Plastic, glass-fibre reinforced thermoplastic
Housing coating	None
Weight	480
Guard locking monitored (Y/N)	Yes
Actuator monitored (Y/N)	No
Idle assignable pushbutton and LED (Y/N)	No
Reaction time	< 150
Duration of risk	< 150
Time to readiness	< 4000
Recommended actuator	MZM 100-B1.1

## Mechanical data

Design of electrical connection	Connector M12, 8-pole
Mechanical life	≥ 1.000.000 operations
notice - Mechanical life	operations for guards ≤ 5 kg; actuating speed ≤ 0,5 m/s
restistance to shock	30 g / 11 ms
Resistance to vibration	10 ... 150 HZ, Amplitude 0,35 mm
Emergency unlocking device (Y/N)	No
Manual release (Y/N)	No
Emergency release (Y/N)	No
Latching (Y/N)	Yes
electrically adjustable latching force	30 ... 100
Permanent magnet (M) typically	15 N
Clamping force F	
- typically	750 N
- guaranteed	500

## Ambient conditions

Ambient temperature	
- Min. environmental temperature	-25
- Max. environmental temperature	+55
Storage and transport temperature	
- Min. Storage and transport temperature	-25
- Max. Storage and transport temperature	+85
Relative humidity	30... 95
- non-condensing	

- non-icing	
Protection class	IP67 to IEC/EN 60529
Protection rating	III
Air clearances and creepage distances To IEC/EN 60664-1	
- Rated impulse withstand voltage $U_{imp}$	0,8 kV
- Overvoltage category	III
- Degree of pollution	3

### Electrical data

---

Number of auxiliary contacts	0
Number of safety contacts	2
Cross circuit/short circuit recognition possible (Y/N)	Yes
Power to unlock	No
Power to lock	Yes
Supply voltage $U_B$ (stabilised PELV)	
- Min. supply voltage	20.4 V DC
- Max. supply voltage	26.4 V DC
Switch frequency	1
Rated insulation voltage $U_i$	32 V DC
Operating current $I_e$	1 A
Utilisation category	DC-13
No-load current $I_0$	max. 0,5 A
Required rated short-circuit current	100 A
Device insulation notice	$\leq 2$ A (if used in accordance with UL 508) Cable length and cable section alter the voltage drop depending on the output current

### Electrical data - Safety inputs

---

Safety inputs	X1 and X2
Rated operating voltage $U_e$	-3 V ... 5 V (Low) 15 V ... 30 V (High)
Operating current $I_e$	> 2 mA / 24 V

### Electrical data - Safety outputs

---

Safety outputs	Y1 and Y2
Fuse rating	short-circuit proof, p-type
Rated operating voltage	0 V ... 4 V under Supply voltage $U_B$
Residual current $I_r$	$\leq 0,5$ mA
Operating current $I_e$	0,25 A
Utilisation category	DC-12, DC-13

### Electrical data - Diagnostic output

---

Serial diagnostics (Y/N)	No
Fuse rating	p-type, short-circuit proof
Rated operating voltage	-3 V ... 5 V (Low) 15 V ... 30 V (High)
Operating current $I_e$	0,05 A
Utilisation category	DC-12, DC-13
Wiring capacitance for serial diagnostics	-
diagnostic signals	guard door closed
Operating principle of the diagnostic output	The short-circuit proof diagnostic output OUT can be used for central

visualisation or control tasks, e.g. in a PLC.

The diagnostic output is not a safety-relevant output!

notice

## Electrical data - Solenoid control IN

---

Rated operating voltage $U_e$	-3 V ... 5 V (Low) 15 V ... 30 V (High)
Operating current $I_e$	typically 10 mA / 24 V, dynamically 20 mA

## LED switching conditions display

---

LED switching conditions display (Y/N)	Yes
LED switching conditions display	
- Supply voltage $U_b$	green LED
- switching condition	yellow LED
- Error functional defect	red LED

## ATEX

---

Explosion protection categories for gases	None
Explosion protected category for dusts	None

## Dimensions

---

Dimensions of the sensor	
- Width of sensor	40
- Height of sensor	179
- Length of sensor	40

## Pin assignment

---

1	A1 Supply voltage $U_b$
2	X1 Safety input 1
3	A2 GND
4	Y1 Safety output 1
5	OUT Diagnostic output
6	X2 Safety input 2
7	Y2 Safety output 2
8	IN Solenoid control
9	without function

## notice

---

As long as the actuating unit remains inserted in the solenoid interlock, the unlocked safety guard can be relocked. The safety outputs then will be enabled again; opening the safety guard therefore is not required.

## Included in delivery

---

Actuators must be ordered separately.

## Ordering code

---

MZM 100

### Guard locking monitored

#### MZM 100 (1)-(2)(3)(4)-A

connector M23, (8 + 1-pole)

connector M12, 8-pole

1 Diagnostic output and 2 Safety outputs, p-type, combined diagnostic signal: guard door closed and interlocking device locked

serial diagnostic output and 2 Safety outputs, p-type

without Latching force

electrically adjustable latching force 30 ... 100 N

Permanent magnet approx. 30 N

### Actuator monitored

#### MZM 100 B (1)-(2)RE(3)-A

connector M23, (8 + 1-pole)

connector M12, 8-pole

1 diagnostic output and 2 safety outputs, all p-type and combined diagnostic signal: safety guard closed and solenoid interlock locked.

serial diagnostic output and 2 Safety outputs, p-type

Permanent magnet approx. 30 N

### Indication legend

Actuator monitored

electrically adjustable latching force 30 ... 100 N

Power to lock

(1)

ST

ST2

(2)

1P2PW

SD2P

(3)

*without*

RE

(4)

M

(1)

ST

ST2

(2)

1P2PW2

SD2P

(3)

M

B

RE

A

## Documents

---

**Operating instructions and Declaration of conformity** (it) 322 kB, 29.11.2012

Code: mrl\_mzm100\_it

**Operating instructions and Declaration of conformity** (cn) 675 kB, 23.11.2018

Code: mrl\_mzm100-100b\_cn

**Operating instructions and Declaration of conformity** (es) 441 kB, 27.08.2018

Code: mrl\_mzm100-100b\_es

**Operating instructions and Declaration of conformity** (en) 443 kB, 16.08.2018

Code: mrl\_mzm100-100b\_en

**Operating instructions and Declaration of conformity** (fr) 441 kB, 15.10.2018

Code: mrl\_mzm100-100b\_fr

**Operating instructions and Declaration of conformity** (pt) 462 kB, 13.09.2018

Code: mrl\_mzm100-100b\_pt

**Operating instructions and Declaration of conformity** (pl) 466 kB, 12.09.2018

Code: mrl\_mzm100-100b\_pl

**Operating instructions and Declaration of conformity (it)** 443 kB, 12.09.2018

Code: mrl\_mzm100-100b\_it

**Operating instructions and Declaration of conformity (nl)** 436 kB, 15.10.2018

Code: mrl\_mzm100-100b\_nl

**Operating instructions and Declaration of conformity (jp)** 624 kB, 16.01.2018

Code: mrl\_mzm100-100b\_jp

**Operating instructions and Declaration of conformity (de)** 386 kB, 16.08.2018

Code: mrl\_mzm100-100b\_de

**Wiring example (de)** 41 kB, 29.09.2009

Code: kmzm1p01

**Wiring example (99)** 19 kB, 22.01.2009

Code: kmzm1I03

**BG-test certificate (de)** 2 MB, 26.08.2014

Code: z\_mzmp03

**Brochure (de)** 6 MB, 15.02.2018

Code: b\_css\_brosch09\_de

**Brochure (en)** 6 MB, 15.02.2018

Code: b\_css\_brosch09\_en

**EAC certification (ru)** 809 kB, 05.10.2015

Code: q\_6040p17\_ru

## Images

---

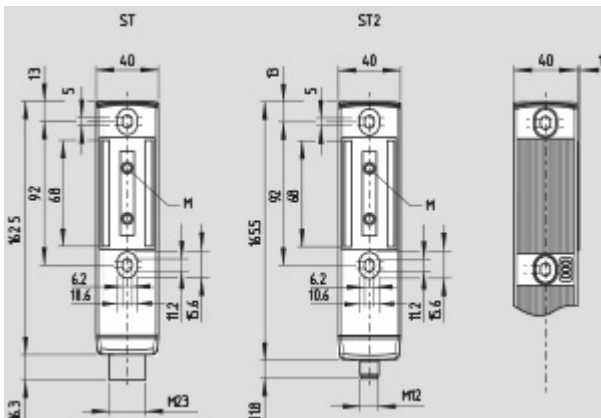

Dimensional drawing (basic component)

---

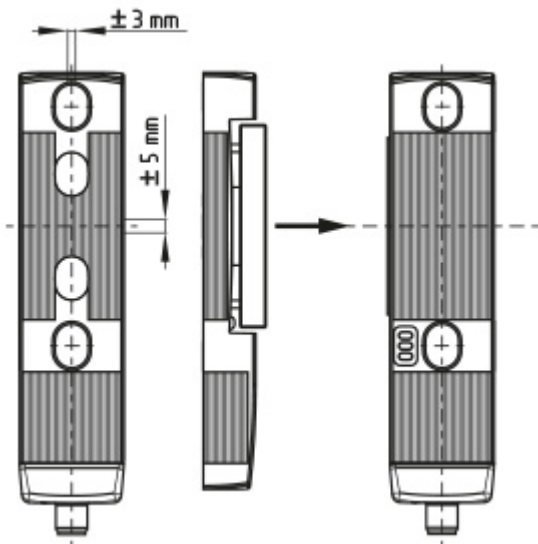

Dimensional drawing (miscellaneous)

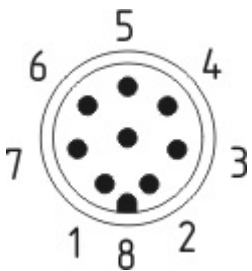

Contact arrangement

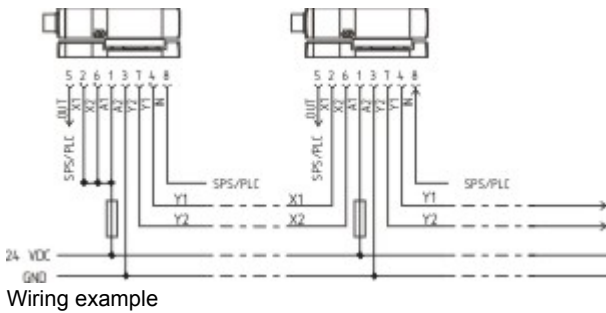

Wiring example

## System components

### Actuator



#### 101204290 - MZM 100-B1.1

- actuator free from play
- neutralisation of undesired noises

### Accessories



#### 101210642 - MZM 100 TARGET

- for the variable setting of the latching force
- gradually adjustable by steps of approx. 10 N within a range from approx. 30 N to 100 N



101185510 - MS MZM 100-W

---

### Connector



### A-K8M12

- Pre-wired cable
- 8-pole

---

K.A. Schmersal GmbH & Co. KG, Mödinghofe 30, D-42279 Wuppertal

The data and values have been checked thoroughly. Technical modifications and errors excepted.

Generiert am 26.08.2019 - 22:01:19h Kasbase 3.3.0.F.64I