

Selection diagram

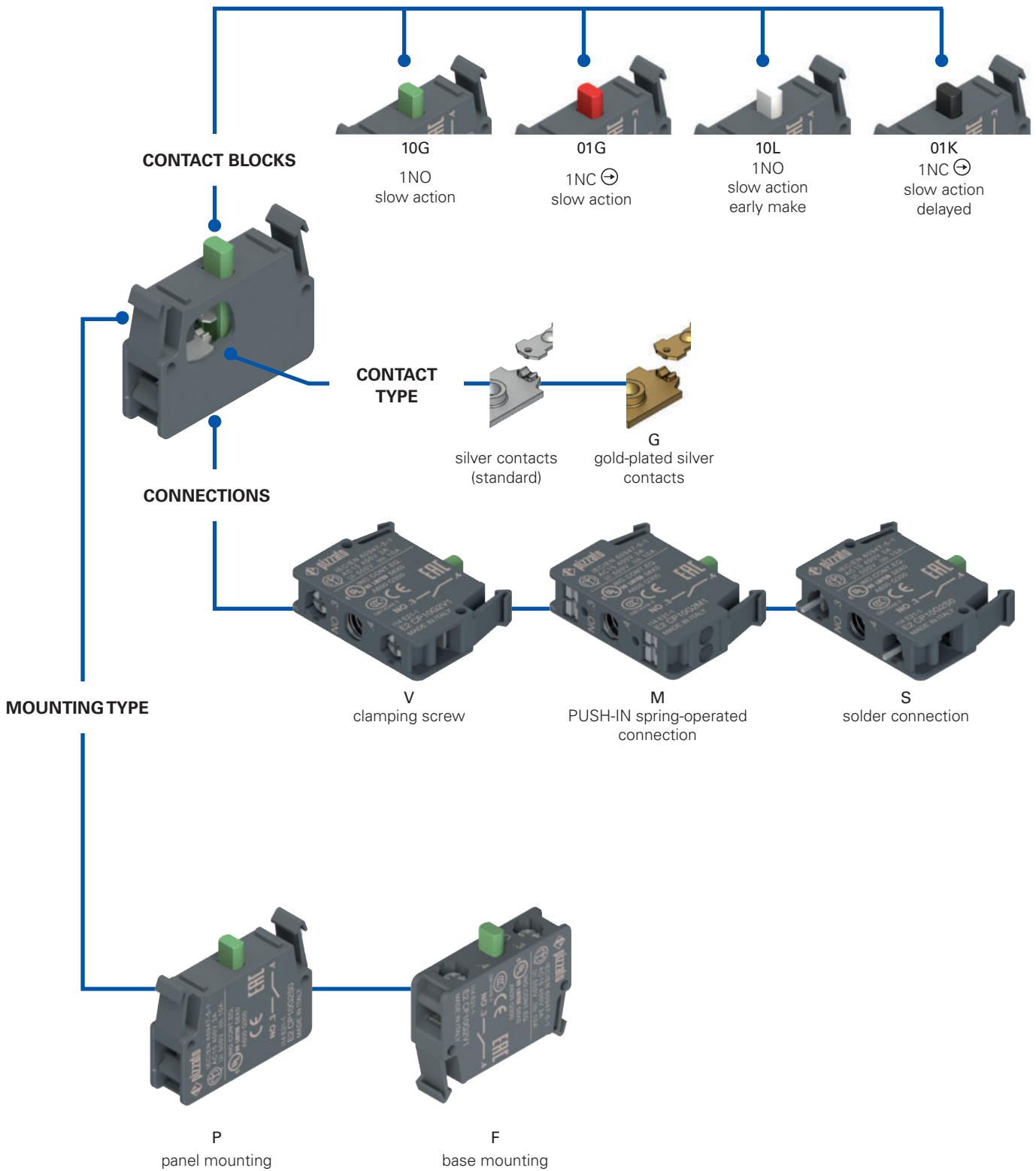

Code structure **Attention!** The feasibility of a code number does not mean the effective availability of a product. Please contact our sales office.

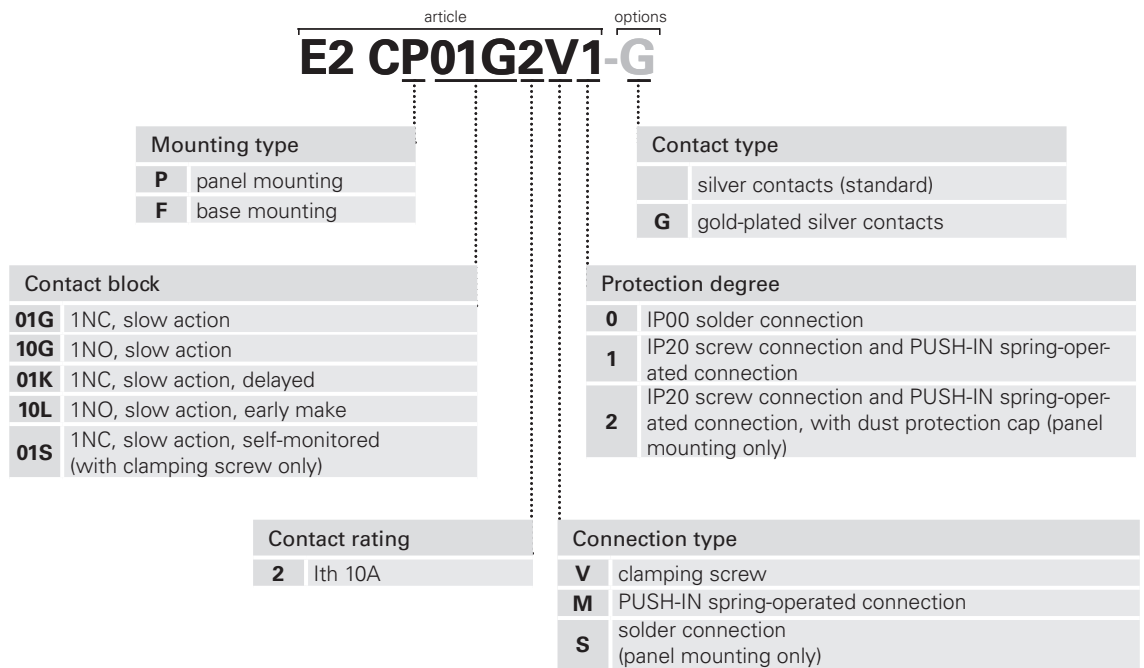

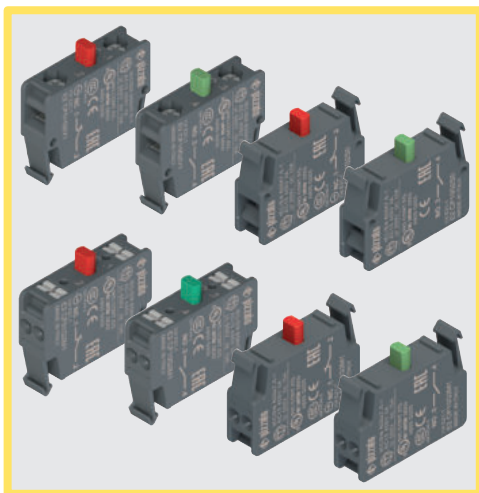

Main features

- Highly reliable contact blocks provided with self-cleaning contacts with quadruple support point
- Versions with gold-plated contacts
- Positive opening NC contacts acc. to IEC 60947-5-1
- Screw, PUSH-IN spring, or solder connections.

Quality marks:



IMO approval:	CA02.04805
UL approval:	E131787
CCC approval:	2013010305631156
EAC approval:	RU C-IT.YT03.B.00035/19

Technical data

General data

Protection degree acc. to EN 60529:	IP20 with screw connection IP20 with PUSH-IN spring-operated connection IP00 with solder connection
Ambient temperature:	-40°C ... +80°C
Mechanical endurance:	20 million operating cycles
Max. actuation frequency:	3600 operating cycles/hour
Utilization requirements:	see page 149

Contact block

Switching force of the contacts:	1.8 N (NO) / 1.4 N (NC) 1.7 N (NO early make) / 1.4 N (NC delayed)
Actuating force at limit of travel:	3.5 N (NO) / 2.3 N (NC) 3.5 N (NO early make) / 1.9 N (NC delayed)
Positive opening force:	17 N
Actuation speed:	min 1 mm/s max. 0.5 m/s
Safety parameter B_{10D} :	1,000,000 (NO), 40,000,000 (NC)
Material of the contacts:	Silver contacts (standard) For low current: silver contacts with 1 µm gold coating (on request)
Contact type:	"V-shape" self-cleaning contacts with quadruple support point

Clamping screw connection

Cable cross section:	min 1 x 0.5 mm ² (1 x AWG 20) max 2 x 2.5 mm ² (2 x AWG 14)
Tightening torque:	0.6 ... 0.8 Nm
Cable stripping length (x):	8 mm

PUSH-IN spring-operated connection

Cable cross section (flexible conductors, with or without wire-end sleeve):	min. 1 x 0.25 mm ² (1 x AWG 24) max. 2 x 1.5 mm ² (2 x AWG 16)
Cable stripping length (x):	min. 8 mm, max. 10 mm



In compliance with standards:

IEC 60947-1, IEC 60947-5-1, IEC 60204-1, EN 60947-1, EN 60947-5-1, EN 60204-1, EN 50581, UL 508, CSA 22-2 N°14.

⚠ Installation for safety applications:

Use only contact blocks marked with the symbol . The safety circuit must always be connected to **NC contacts** (normally closed contacts: .1-2)

Compliance with the requirements of:

Low Voltage Directive 2014/35/EU,
EMC Directive 2014/30/EU,
RoHS Directive 2011/65/EU.

Positive contact opening in conformity with standards:

IEC 60947-5-1, EN 60947-5-1.

Electrical data

Thermal current (I_{th}):	10 A
Rated insulation voltage (U_i):	500 Vac/dc
Protection against short circuits:	type gG/gL fuse 10 A 500 V
Rated impulse withstand voltage (U_{imp}):	8 kV
Pollution degree:	3

Utilization category

Alternating current: AC15 (50 ... 60 Hz)					
U_e (V)	24	48	120	250	400
I_e (A)	6	6	6	6	3
Direct current: DC13					
U_e (V)	24	48	125	250	
I_e (A)	2.5	1.3	0.6	0.3	

Features approved by UL

Electrical ratings: A600 pilot duty (720 VA, 120-600 Vac)
Q300 pilot duty (69 VA, 125-250 Vdc)

Note:
For contact block series E2 C provided with clamping screw terminals: use 60 or 75 °C copper (Cu) conductor and wire size range 14-20 AWG, stranded or solid. The terminal tightening torque of 7.1 Lb In (0.8 Nm).

For contact block series E2 C provided with screw less type terminals: use 60 or 75 °C copper (Cu) conductor and wire size range 16-24 AWG, stranded. These terminals are suitable also for stranded conductors prepared with ZMLF ferrules. Recommended stripping length: 8 mm.

Please contact our technical department for the list of approved products.

Features approved by IMQ

Rated insulation voltage (Ui): 500 V
Conventional free air thermal current (Ith): 10 A
Thermal current inside housing (Ithe): 10 A
Rated impulse withstand voltage (Uimp): 8 kV
Protection degree of the housing: IP20 (screw terminals), IP00 (solder terminals)
Terminals: screw terminals
Utilization category: AC15
Operating voltage (Ue): 400 Vac (50/60 Hz)
Operating current (Ie): 3 A
Forms of the contact element: X, Y
Positive opening of contacts on contact blocks 01G, 01K
In compliance with standards: EN 60947-1, EN 60947-5-1 + A1:2009, fundamental requirements of the Low Voltage Directive 2014/35/EU.

Please contact our technical department for the list of approved products.

General data

Positive opening



All NC contacts are suitable for safety applications. The NC contacts are positive opening contacts acc. to IEC 60947-5-1.

Screw connection with clamping screw plates

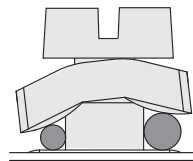

The clamping screw plates of the contact blocks are provided with a particular "roofing tile" structure and are loosely coupled to the clamping screw. This way, during the wires fixing, the clamping screw plate is able to suit to cables of different diameters and tends to tighten the wires toward the screw instead of permitting them to escape towards the outside.

PUSH-IN spring-operated connection



The PUSH-IN spring connection allows quick and simple wiring, as the wire just needs to be inserted into the appropriate hole in order to establish the electrical connection and automatically secure the wire. The reduced force required to insert the wire allows completely tool-free connection by using wires with crimped wire-end sleeves. They are released by pressing a special wire release button - including individually - with any tool, without the need to use a screwdriver of a predefined size. In addition, the contact block has holes for insertion of tester tips, so that electrical measurements can be carried out, without having to remove the connecting cables.

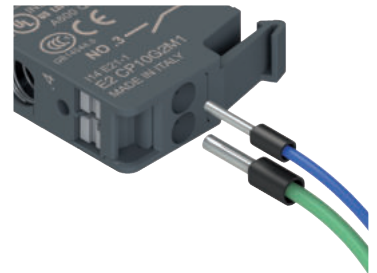

High-reliability self-cleaning contacts

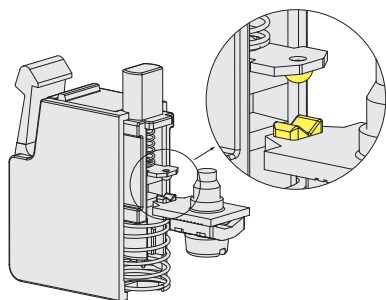

"V-shape" self-cleaning contacts with quadruple support point. This type of shape, thanks to the presence of the double support point, makes it possible to drastically reduce the probability of contact commutation failure. In addition to this, it improves considerably the reliability in the presence of dust.

Solder connection on printed circuit

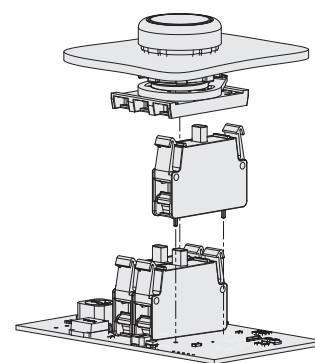

Versions with panel mounting of the EROUND series contact blocks with solder pin are available. If there is no wiring but a printed circuit, these contact blocks can be directly welded on the latter.

Gold-plated silver contacts

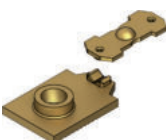

The contact blocks can be supplied with silver electric contacts with a special gold-plated surface, with total gold thickness of one micron. This type of treatment can be useful in environments which are aggressive against silver and in case of very small electric charges, usually with low voltages and supply currents.

Selection table for contact blocks

Packs of 10 pcs.



Contact block	Panel mounting			Base mounting	
	Screw connection	PUSH-IN spring-operated connection	Solder connection	Screw connection	PUSH-IN spring-operated connection
1NC \rightarrow slow action	E2 CP01G2V1 	E2 CP01G2M1 	E2 CP01G2S0 	E2 CF01G2V1 	E2 CF01G2M1
1NO slow action	E2 CP10G2V1 	E2 CP10G2M1 	E2 CP10G2S0 	E2 CF10G2V1 	E2 CF10G2M1
1NC \rightarrow slow action, delayed	E2 CP01K2V1 	E2 CP01K2M1 	E2 CP01K2S0 	E2 CF01K2V1 	E2 CF01K2M1
1NO slow action, early make	E2 CP10L2V1 	E2 CP10L2M1 	E2 CP10L2S0 	E2 CF10L2V1 	E2 CF10L2M1

Complete units with contact block and mounting adapter



Contacts			Panel mounting	
pos. 2	pos. 3	pos. 1	Screw connection	PUSH-IN spring-operated connection
-	1NO	-	E2 AC-XXBC0010 E2 1BAC11 + E2 CP10G2V1	E2 AC-XXBC0147 E2 1BAC11 + E2 CP10G2M1
-	1NC \rightarrow	-	E2 AC-XXBC0009 E2 1BAC11 + E2 CP01G2V1	E2 AC-XXBC0146 E2 1BAC11 + E2 CP01G2M1

Other combinations on request.

Contacts			Panel mounting	
pos. 2	pos. 3	pos. 1	Screw connection	PUSH-IN spring-operated connection
1NO	-	1NO	E2 AC-XXBC0012 E2 1BAC11 + E2 CP10G2V1 + E2 CP10G2V1	E2 AC-XXBC0149 E2 1BAC11 + E2 CP10G2M1 + E2 CP10G2M1
1NC \rightarrow	-	1NC \rightarrow	E2 AC-XXBC0011 E2 1BAC11 + E2 CP01G2V1 + E2 CP01G2V1	E2 AC-XXBC0148 E2 1BAC11 + E2 CP01G2M1 + E2 CP01G2M1
1NC \rightarrow	-	1NO	E2 AC-XXBC0028 E2 1BAC11 + E2 CP10G2V1 + E2 CP01G2V1	E2 AC-XXBC0150 E2 1BAC11 + E2 CP10G2M1 + E2 CP01G2M1

Dimensions

All values in the drawings are in mm

Contact blocks for panel mounting with screw connection, PUSH-IN spring-operated connection

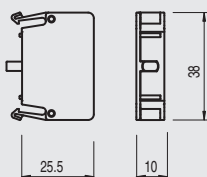

Contact blocks for base mounting, with screw connection, PUSH-IN spring-operated connection

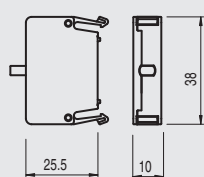

Contact blocks for panel mounting with solder connection

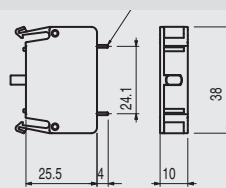

Ø 1.4 mm holes on PCB

Dust protection

Packs of 50 pcs.



Article	Description
VE PR3A70	Transparent dust protection for E2 series contact blocks. Suitable for all panel mounting contact blocks.

→ The 2D and 3D files are available at www.pizzato.com

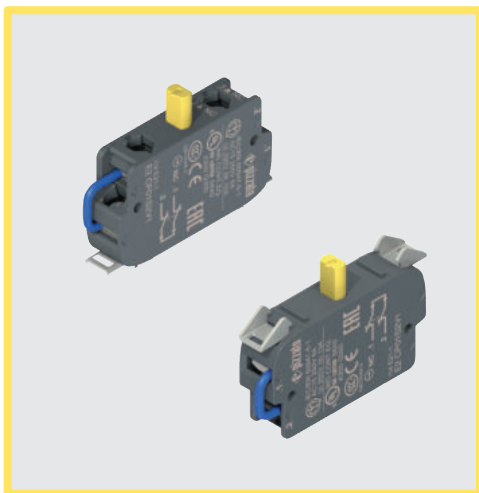

Main features

- Self-monitored contact block. Electrical circuit opening indicates the detachment from the device
- Versions with gold-plated contacts
- Positive opening NC contacts acc. to IEC 60947-5-1

Quality marks:



IMQ approval:	CA02.04805
UL approval:	E131787
CCC approval:	2013010305631156
EAC approval:	RU C-IT.YT03.B.00035/19

Technical data

General data

Protection degree:	IP20 acc. to EN 60529 at the terminals
Ambient temperature:	-40°C ... +80°C
Mechanical endurance:	20 million operating cycles
Max. actuation frequency:	3600 operating cycles/hour
Utilization requirements:	see page 149

Contact block

Switching force of the contacts:	2.9 N
Actuating force at limit of travel:	5 N
Positive opening force:	17 N
Actuation speed:	min 1 mm/s max. 0.5 m/s
Safety parameter B_{10D} :	40,000,000 (NC)
Material of the contacts:	Silver contacts (standard) For low current: silver contacts with 1 μ m gold coating (on request)

Contact type:

"V-shape" self-cleaning contacts with quadruple support point

Cable cross section:

min $1 \times 0.34 \text{ mm}^2$ (1 x AWG 22)
max. $2 \times 1.5 \text{ mm}^2$ (2 x AWG 16)

Cable stripping length:

7 mm

Tightening torque of the terminal screws:

0.6 ... 0.8 Nm

In compliance with standards:

IEC 60947-1, IEC 60947-5-1, IEC 60204-1, EN 60947-1, EN 60947-5-1, EN 60204-1, EN 50581, UL 508, CSA 22-2 N°14.

⚠ Installation for safety applications:

Use only contact blocks marked with the symbol \oplus . The safety circuit must always be connected to **NC contacts** (normally closed contacts: .1-.2)

Compliance with the requirements of:

Low Voltage Directive 2014/35/EU, EMC Directive 2014/30/EU, RoHS Directive 2011/65/EU.

Positive contact opening in conformity with standards:

IEC 60947-5-1, EN 60947-5-1.

Electrical data

Thermal current (I _{th}):	10 A
Rated insulation voltage (U _i):	250 Vac/dc
Protection against short circuits:	type gG/gL fuse 10 A 500 V
Rated impulse withstand voltage (U _{imp}):	4 kV
Pollution degree:	3

Utilization category

Alternating current: AC15 (50 ... 60 Hz)				
U _e (V)	24	48	120	250
I _e (A)	6	6	6	6
Direct current: DC13				
U _e (V)	24	48	125	250
I _e (A)	2.5	1.3	0.6	0.3

Functioning of self-monitored contact blocks

The operating principle of the self-monitoring contact blocks ensures that their associated control devices are free from faults and malfunctions caused by contacts separating, and that the safety function remains permanently available during machine operation.

Characterised by two NC contacts connected in series; during normal operation, both contacts are in the closed position.

If the emergency stop button is pressed, the direct action of the force exerted on the control device opens the first contact (positive opening); this interrupts the safety circuit, while the second contact remains closed.

If the housing cover is removed (in the case of base-mounted contact blocks), or if the contact block or mounting adapter becomes unintentionally separated (in the case of panel-mounted contact blocks), the second contact opens, which always interrupts the same safety circuit.

When using the machine in this way, the operator can always identify any hidden faults that have occurred internally to the electrical enclosures.

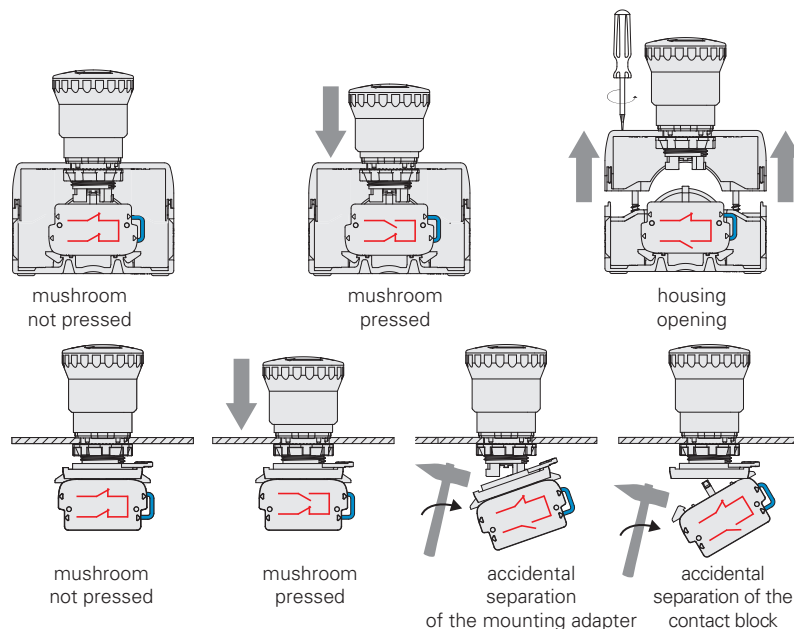

High-reliability self-cleaning contacts

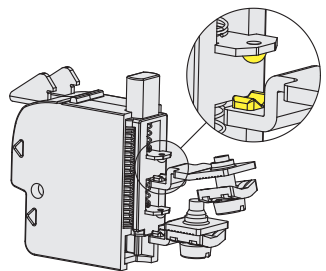

“V-shape” self-cleaning contacts with quadruple support point. This type of shape, thanks to the presence of the double support point, makes it possible to drastically reduce the probability of contact commutation failure. In addition to this, it improves considerably the reliability in the presence of dust.

Positive opening



All NC contacts are suitable for safety applications. The NC contacts are positive opening contacts acc. to IEC 60947-5-1.

Features approved by UL

Electrical ratings: A300 pilot duty (720 VA, 120-240 V ac)
Q300 pilot duty (69 VA, 125-250 V dc)

Note:
Use 60 or 75 °C copper (CU) conductor and wire size range 16-22 AWG, stranded or solid.
The terminal tightening torque of 7.1 Lb In (0.8 Nm).

Please contact our technical department for the list of approved products.

Features approved by IMQ

Rated insulation voltage (U_i): 250 V
Conventional free air thermal current (I_{th}): 10 A
Rated impulse withstand voltage (U_{imp}): 4 kV
Protection degree of the housing: IP20
Utilization category: AC-15
Operating voltage (U_e): 250 Vac (50/60 Hz)
Operating current (I_e): 6 A



Forms of the contact element: Y, Y+Y, X+X, Zb
Positive opening of contacts on contact blocks 01S, 11G, 02G
In compliance with standards: EN 60947-1:2007 + A1:2011, EN 60947-5-1:2004 + A1:2009, fundamental requirements of the Low Voltage Directive 2006/95/EC.

Please contact our technical department for the list of approved products.



Selection table for contact blocks

Packs of 5 pcs.



Contact block	Panel mounting Screw connection
1NC,  slow action, self-monitored 	E2 CP01S2V1 2.3 1.1 0 1.1  2.1 5

The self-monitoring contact block with panel mounting can be installed to any position on the 3-slot mounting adapter, and in the two central positions only on the 4-slot mounting adapter.

Contact block	Base mounting Screw connection
1NC,  slow action, self-monitored 	E2 CF01S2V1 2.3 1.1 0 1.1  2.1 5

The self-monitoring contact block with base mounting can be installed only in the central position under the device. The central position on the bottom of the housing is identified with number 3.

Complete units with contact block and mounting adapter



Contacts			Panel mounting Screw connection
pos. 2	pos. 3	pos. 1	
-	1NC  SELF-MONITORED	-	E2 AC-XXBC0139 E2 1BAC11 + E2 CP01S2V1

Other combinations on request.

Installation of several single, double and self-monitored contact blocks

Always install self-monitored contact blocks directly on the mounting adapter.

Do not install self-monitored contact blocks on standard contact blocks. Forbidden application!

Per each emergency button no more than two self-monitored contact blocks can be installed.

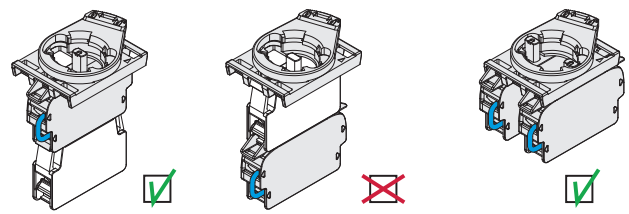

Dust protection Packs of 50 pcs.

Article	Description
 VE PR3A70	Transparent dust protection for E2 series contact blocks. Suitable for all panel mounting contact blocks.

→ The 2D and 3D files are available at www.pizzato.com

Contact block dimensions All values in the drawings are in mm

