



**Model Number**

**OBG5000-R101-2EP-IO-0,3M-V1**

Retroreflective sensor (glass)  
with fixed cable and M12 connector, 4-pin

**Features**

- Miniature design with versatile mounting options
- Detects transparent objects, i.e., clear glass, PET and transparent films
- Two machines in one: clear object detection or reflection operating mode with long range
- High degree of protection IP69K
- IO-link interface for service and process data

**Product information**

The miniature optical sensors are the first devices of their kind to offer an end-to-end solution in a small single standard design — from thru-beam sensor through to a distance measurement device. As a result of this design, the sensors are able to perform practically all standard automation tasks.

The DuraBeam laser sensors are durable and can be used in the same way as a standard sensor.

The use of Multi Pixel Technology gives the standard sensors a high level of flexibility and enables them to adapt more effectively to their operating environment.

**Dimensions**

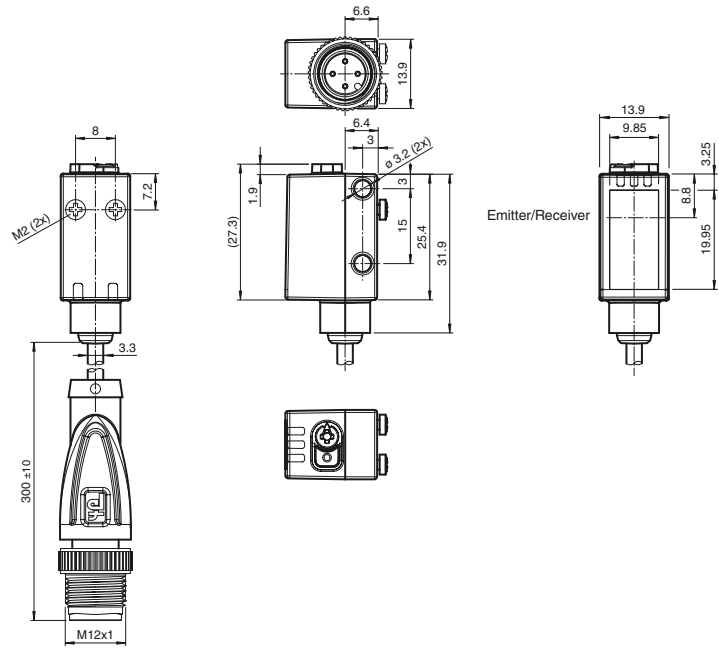

**Electrical connection**

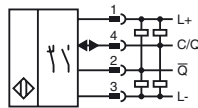

**Pinout**

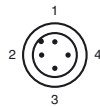

Wire colors in accordance with EN 60947-5-2

1	BN	(brown)
2	WH	(white)
3	BU	(blue)
4	BK	(black)

**Indicators/operating means**

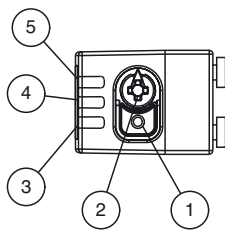

1	Teach-in button
2	Mode rotary switch
3	Operating indicator / dark on
4	Signal indicator
5	Operating indicator / light on

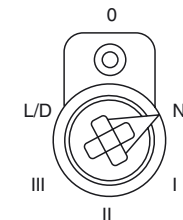

N	Normal mode
I	10 % contrast detection
II	18 % contrast detection
III	40 % contrast detection
L/D	Switching type
0	Keylock

Release date: 2018-12-19 10:36 Date of issue: 2018-12-19 267075-100067\_eng.xml

**Technical data****General specifications**

Effective detection range	0 ... 3.5 m in TEACH mode ; 0 ... 5 m at switch position "N"
Reflector distance	0 ... 3.5 m in TEACH mode ; 0 ... 5 m at switch position "N"
Threshold detection range	6 m
Reference target	H85-2 reflector
Light source	LED
Light type	modulated visible red light
LED risk group labelling	exempt group
Diameter of the light spot	approx. 170 mm at a distance of 3.5 m
Angle of divergence	approx. 5 °
Ambient light limit	EN 60947-5-2

**Functional safety related parameters**

MTTF <sub>d</sub>	600 a
Mission Time (T <sub>M</sub> )	20 a
Diagnostic Coverage (DC)	0 %

**Indicators/operating means**

Operation indicator	LED green: constantly on - power on flashing (4Hz) - short circuit flashing with short break (1 Hz) - IO-Link mode
Function indicator	Yellow LED: Permanently lit - light path clear Permanently off - object detected Flashing (4 Hz) - insufficient operating reserve
Control elements	Teach-In key
Control elements	5-step rotary switch for operating modes selection
Contrast detection levels	10 % - clean, water filled PET bottles 18 % - clear glass bottles 40 % - colored glass or opaque materials Adjustable via rotary switch

**Electrical specifications**

Operating voltage	U <sub>B</sub>	10 ... 30 V DC
Ripple		max. 10 %
No-load supply current	I <sub>0</sub>	< 25 mA at 24 V supply voltage
Protection class		III

**Interface**

Interface type	IO-Link ( via C/Q = pin 4 )
Transfer rate	COM 2 (38.4 kBaud)
IO-Link Revision	1.1
Min. cycle time	2.3 ms
Process data width	Process data input 2 Bit Process data output 2 Bit
SIO mode support	yes
Device ID	0x110A01 (1116673)
Compatible master port type	A

**Output**

Switching type	The switching type of the sensor is adjustable. The default setting is: C/Q - Pin4: NPN normally open / dark-on, PNP normally closed / light-on, IO-Link /Q - Pin2: NPN normally closed / light-on, PNP normally open / dark-on	
Signal output	2 push-pull (4 in 1) outputs, short-circuit protected, reverse polarity protected, overvoltage protected	
Switching voltage	max. 30 V DC	
Switching current	max. 100 mA , resistive load	
Usage category	DC-12 and DC-13	
Voltage drop	U <sub>d</sub>	≤ 1.5 V DC
Switching frequency	f	500 Hz
Response time		1 ms

**Conformity**

Communication interface	IEC 61131-9
Product standard	EN 60947-5-2

**Ambient conditions**

Ambient temperature	-20 ... 60 °C (-4 ... 140 °F) , movable cable not appropriate for conveyor chains
Storage temperature	-40 ... 70 °C (-40 ... 158 °F)

**Mechanical specifications**

Housing width	13.9 mm
Housing height	33.8 mm
Housing depth	18.3 mm
Degree of protection	IP67 / IP69 / IP69K
Connection	300 mm fixed cable with M12 x 1, 4-pin connector
Material	
Housing	PC (Polycarbonate)
Optical face	PMMA

**Accessories****IO-Link-Master02-USB**

IO-Link master, supply via USB port or separate power supply, LED indicators, M12 plug for sensor connection

**OMH-R101**

Mounting Clamp

**OMH-R101-Front**

Mounting Clamp

**OMH-4.1**

Mounting Clamp

**OMH-ML6**

Mounting bracket

**OMH-ML6-U**

Mounting bracket

**OMH-ML6-Z**

Mounting bracket

**OFR-100/100**

Reflective tape 100 mm x 100 mm

**REF-H33**

Reflector with screw fixing

**REF-H50**

Reflector, rectangular 51 mm x 61 mm, mounting holes, fixing strap

**REF-H85-2**

Reflector, rectangular 84.5 mm x 84.5 mm, mounting holes

**REF-H32G-2****REF-ORR50G-2****V31-GM-2M-PUR**

Female cordset, M8, 4-pin, PUR cable

**V31-WM-2M-PUR**

Female cordset, M8, 4-pin, PUR cable

Other suitable accessories can be found at [www.pepperl-fuchs.com](http://www.pepperl-fuchs.com)

Mass	approx. 17 g
Cable length	0.3 m

**Approvals and certificates**

UL approval E87056 , cULus Listed , class 2 power supply , type rating 1

**Curves/Diagrams**

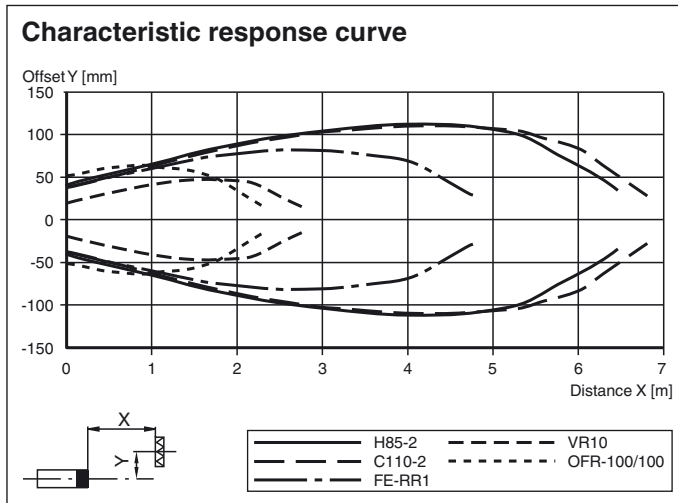

**Relative received light strength in switch position "N"**

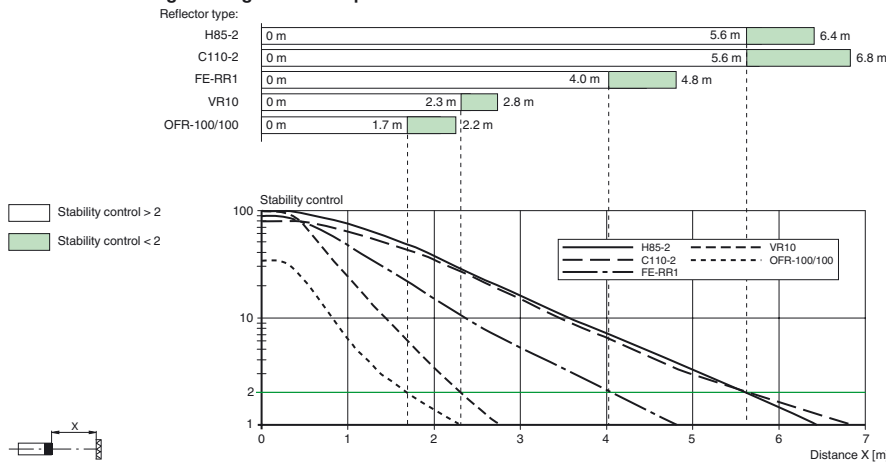

**Settings**

**Teach-in:**

Use the rotary switch to select the required operating mode: Normal mode (N) or contrast level I – III.

To teach in a threshold or activate an operating mode, press the "TI" button until the yellow and green LEDs flash in phase (approx. 1 s).

Release the "TI" button. Teach-in starts.

Successful teach-in is indicated by alternating flashing (2.5 Hz) of the yellow and green LEDs. The sensor will now operate in the selected operating mode with the taught-in threshold.

An unsuccessful teach-in is indicated by rapidly alternating flashing (8 Hz) of the yellow and green LEDs. After an unsuccessful teach-in, the sensor continues to operate with the previous valid setting after the relevant visual fault signal is issued.

Every taught-in switching threshold can be re-taught (overwritten) by pressing the "TI" button again.

Note: To ensure that the device functions reliably in Contrast mode, the device must be powered on at least 30 s before Teach-in.

**Setting the Device to Maximum Sensitivity**

Use the rotary switch to select the Normal mode (N) position.

Press the "TI" button for > 4 s. The yellow and green LEDs will go out.

Release the "TI" button.

The settings will be reset to maximum sensitivity. After successfully resetting, the yellow and green LEDs will flash alternately (2.5 Hz).

**Switching between light on/dark on**

Use the rotary switch to select the light on/dark on (L/D) position.

Press the "TI" button for > 1 s.

The respective operating indicator LED (L/D) will illuminate green and the switching type will change.

To reset the switching type, press the "TI" button for > 4 s.

The respective operating indicator LED (L/D) will illuminate green and the operating indicator will be reset to the most recently active switching

Release date: 2018-12-19 10:36 Date of issue: 2018-12-19 267075-100067\_eng.xml

type.

### Reset to Default Settings

Use the rotary switch to select the O position.

Press the "TI" button for > 10 s. The yellow and the green LEDs will both switch off.

Release the "TI" button. The yellow LED is on.

After resetting, the sensor will operate with the following default settings:

- Normal mode (N)
- Maximum sensitivity adjustment
- Dark on
- Pin 2 (white core): antivalent switching output