



## Model Number

NRB15-30GS50-E2-IO-V1

## Features

- 15 mm flush
- Reduction factor = 1
- Magnetic field resistant
- IO-link interface for service and process data
- Switch point mode or window mode can be set
- Switching function, stability alarm and pulse extension can be set

## Description

Reduction factor 1 sensors reliably detect different metals with the same switch state. The integrated IO-Link interface enables clear identification of the sensor and diagnosis of the sensor condition. When using the sensor, parameters and operating modes can be optimally configured specifically for the intended application. In addition to setting the switching function and a pulse extension, the user can select either switch point mode or window mode in combination with a stability alarm. In switch point mode, the stability alarm signals the detection of an object in the area between the assured operating distance and operating distance  $s_n$ . In window mode, it signals the detection of an object below the window between operating distance  $s_n$  and the nearest operating distance. A stability alarm is displayed to the user via a flashing LED and process data.

## Accessories

### IO-Link-Master02-USB

IO-Link master, supply via USB port or separate power supply, LED indicators, M12 plug for sensor connection

### BF 30

Mounting flange, 30 mm

### EXG-30

Quick mounting bracket with dead stop

### V1-G

Female connector, M12, 4-pin, field attachable

### V1-W

Female connector, M12, 4-pin, field attachable

### V1-G-2M-PVC

Female cordset, M12, 4-pin, PVC cable

### V1-W-2M-PVC

Female cordset, M12, 4-pin, PVC cable

## Technical Data

### General specifications

Switching function		Normally open/closed (NO/NC) programmable
Output type		PNP
Rated operating distance	$s_n$	15 mm (factory setting)
Near operating distance		10 mm (can be activated by software)
Installation		flush
Output polarity		DC
Assured operating distance	$s_a$	0 ... 12.15 mm
Reduction factor $r_{Al}$		1
Reduction factor $r_{Cu}$		1
Reduction factor $r_{304}$		1
Reduction factor $r_{St37}$		1
Output type		3-wire

### Nominal ratings

Operating voltage	$U_B$	10 ... 30 V DC
Switching frequency	$f$	0 ... 600 Hz (switch point mode) 0 ... 25 Hz (window mode, switch point mode with stability alarm)
Hysteresis	H	typ. 3 %
Reverse polarity protection		reverse polarity protected
Short-circuit protection		pulsing
Voltage drop	$U_d$	$\leq 0.5$ V
Operating current	$I_L$	0 ... 200 mA
Off-state current	$I_r$	0 ... 0.5 mA typ. 60 $\mu$ A at 25 °C
No-load supply current	$I_0$	$\leq 15$ mA
Time delay before availability	$t_v$	$\leq 150$ ms
Constant magnetic field	B	200 mT
Alternating magnetic field	B	200 mT
Status indicator		Multihole-LED, yellow

### Functional safety related parameters

MTTF <sub>d</sub>	362 a
Mission Time (T <sub>M</sub> )	20 a
Diagnostic Coverage (DC)	0 %

### Interface

Interface type	IO-Link ( via C/Q = pin 4 )
Transfer rate	COM 2 (38.4 kBaud)
IO-Link Revision	1.1
Min. cycle time	2.3 ms
Process data width	Process data input (control system side): 2 Bit Process data output (control system side): none
SIO mode support	yes
Device ID	0x201003 (2101251)
Compatible master port type	A

### Ambient conditions

Ambient temperature	-25 ... 70 °C (-13 ... 158 °F)
Storage temperature	-40 ... 85 °C (-40 ... 185 °F)

### Mechanical specifications

Connection type	Connector plug M12 x 1, 4-pin
Housing material	Stainless steel 1.4305 / AISI 303
Sensing face	PBT
Degree of protection	IP67
Mass	153 g

### Factory settings

Default setting	operating mode = switch point mode with stability alarm switching function = Normally open (NO) switching distance = 15 mm
-----------------	--

### General information

Scope of delivery	2 self locking nuts in scope of delivery
-------------------	--

### Compliance with standards and directives

Standard conformity	
Standards	EN 60947-5-2:2007 EN 60947-5-2/A1:2012 IEC 60947-5-2:2007 IEC 60947-5-2 AMD 1:2012

### Approvals and certificates

Protection class	II
Rated insulation voltage	$U_i$ 60 V
Rated impulse withstand voltage	$U_{imp}$ 800 V
UL approval	cULus Listed, General Purpose Class 2 power source
CCC approval	CCC approval / marking not required for products rated $\leq 36$ V

Release date: 2019-06-05 09:47 Date of issue: 2019-06-05 306533-0021\_eng.xml

Dimensions

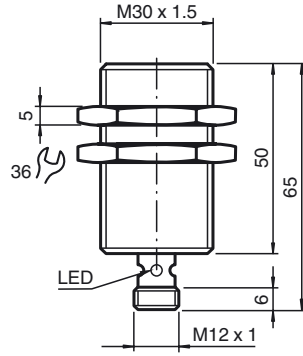

Electrical Connection

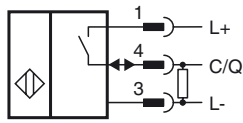

Pinout

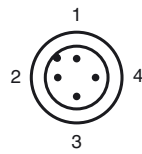

Wire colors in accordance with EN 60947-5-2

1	BN	(brown)
2	WH	(white)
3	BU	(blue)
4	BK	(black)

**Switching output modes**

**Switch point mode at rated operating distance  $s_n$**

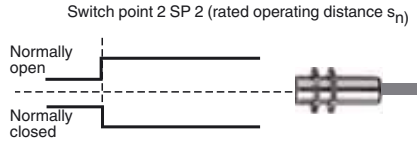

**Switch point mode with near operating distance**

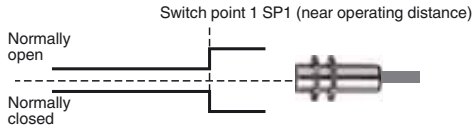

**Window mode**

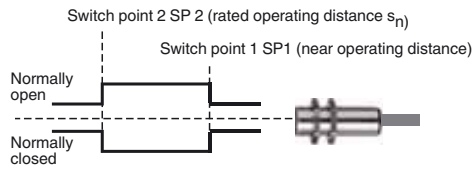

**Stability alarm**

**Switch point mode with stability alarm (factory default)**

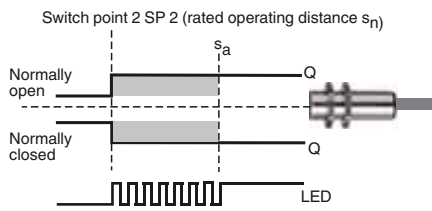

**Window mode with stability alarm**

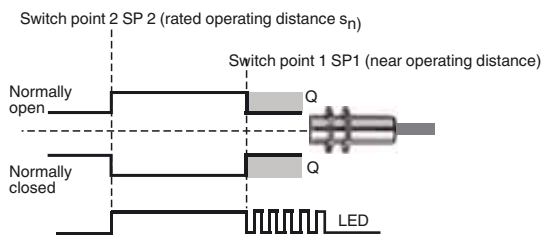

Release date: 2019-06-05 09:47 Date of issue: 2019-06-05 306533-0021\_eng.xml