



Thru-beam sensor

OBE6000-12GM40-SE5-V1



- Robust M12 threaded housing
- Less space required
- Light-on/dark-on, programmable
- Degree of protection IP67

Thru-beam sensor, M12 threaded housing design, metal housing, front optical face, 6 m detection range, red light, light/dark on, 1 PNP output, M12 plug



Dimensions

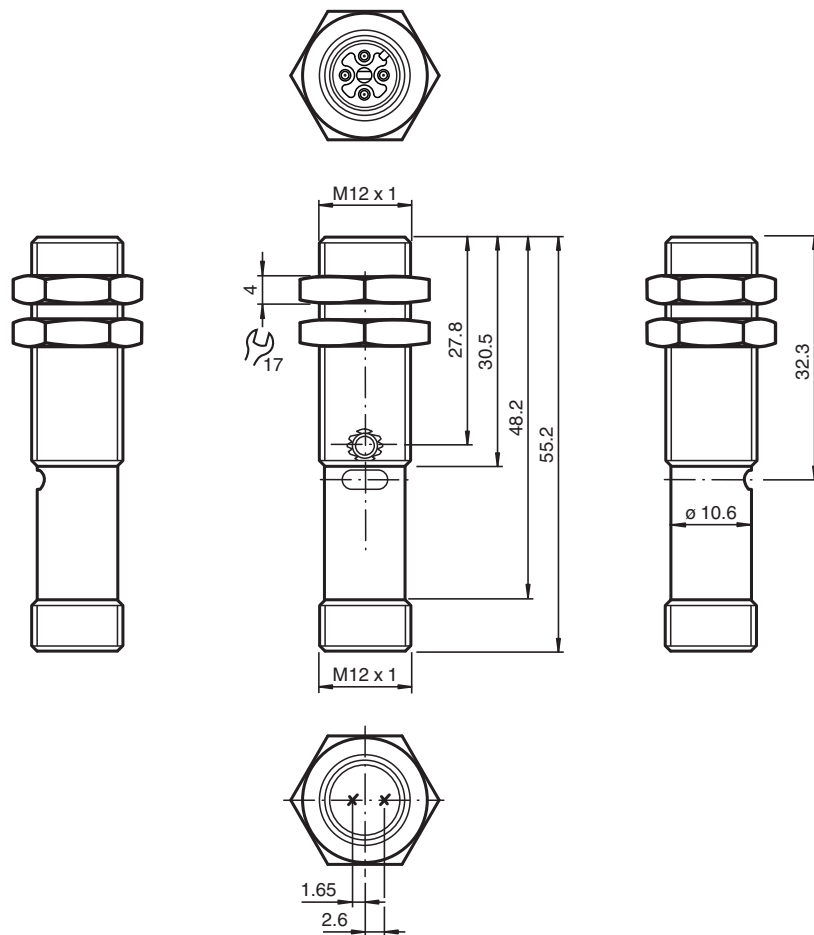

Technical Data

System components

Emitter OBE6000-12GM40-V1

Release date: 2023-03-28 Date of issue: 2023-03-28 Filename: 257816_eng.pdf

Refer to "General Notes Relating to Pepperl+Fuchs Product Information".

Pepperl+Fuchs Group
www.pepperl-fuchs.com

USA: +1 330 486 0001
fa-info@us.pepperl-fuchs.com

Germany: +49 621 776 1111
fa-info@de.pepperl-fuchs.com

Singapore: +65 6779 9091
fa-info@sg.pepperl-fuchs.com

PF PEPPERL+FUCHS

Technical Data

Receiver		OBE6000-12GM40-E5-V1
General specifications		
Effective detection range		0 ... 6000 mm
Threshold detection range		8500 mm
Adjustment range		500 ... 8500 mm
Reference target		receiver
Light source		LED
Light type		red , 640 nm
Angle deviation		+/- 2 °
Diameter of the light spot		approx. 800 mm at a distance of 6 m Red light
Opening angle		approx. 4
Optical face		frontal
Ambient light limit		EN 60947-5-2 ; 20000 Lux
Functional safety related parameters		
MTTF _d		806 a
Mission Time (T _M)		20 a
Diagnostic Coverage (DC)		0 %
Indicators/operating means		
Operation indicator		LED green: Power on
Function indicator		LED yellow: lights up when receiving the light beam ; flashes when falling short of the operating reserve; OFF when light beam is interrupted
Control elements		sensitivity adjustment , receiver
Electrical specifications		
Operating voltage	U _B	10 ... 30 V DC , class 2
Ripple		10 %
No-load supply current	I ₀	≤ 30 mA (emitter and receiver)
Input		
Control input		light on +UB dark on: 0 V
Output		
Switching type		light/dark on electrically switchable
Signal output		1 PNP output, short-circuit protected, reverse polarity protected, open collector
Switching voltage		max. 30 V DC
Switching current		max. 100 mA
Voltage drop	U _d	≤ 2 V
Switching frequency	f	≤ 1000 Hz
Response time		0.5 ms
Conformity		
Product standard		EN 60947-5-2
Compliance with standards and directives		
Standard conformity		
Standards		UL 508
Approvals and certificates		
UL approval		cULus Listed, Class 2 Power Source, Type 1 enclosure
CCC approval		CCC approval / marking not required for products rated ≤36 V
Approvals		CE, cULus Listed 57M3 (Only in association with UL Class 2 power supply; Type 1 enclosure)
Ambient conditions		
Ambient temperature		-30 ... 60 °C (-22 ... 140 °F)
Storage temperature		-40 ... 70 °C (-40 ... 158 °F)
Mechanical specifications		
Degree of protection		IP67
Connection		4-pin, M12 x 1 connector
Material		

Release date: 2023-03-28 Date of issue: 2023-03-28 Filename: 257816_eng.pdf

Refer to "General Notes Relating to Pepperl+Fuchs Product Information".

Pepperl+Fuchs Group
www.pepperl-fuchs.com

USA: +1 330 486 0001
fa-info@us.pepperl-fuchs.com

Germany: +49 621 776 1111
fa-info@de.pepperl-fuchs.com

Singapore: +65 6779 9091
fa-info@sg.pepperl-fuchs.com

 PEPPERL+FUCHS

Technical Data

Housing	brass, nickel-plated
Optical face	PMMA
Mass	approx. 15 g (device)

Connection

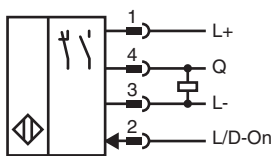
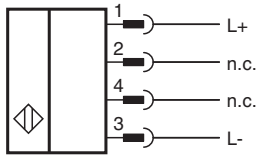

Connection Assignment

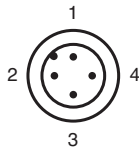

Wire colors in accordance with EN 60947-5-2

1	BN	(brown)
2	WH	(white)
3	BU	(blue)
4	BK	(black)

Assembly

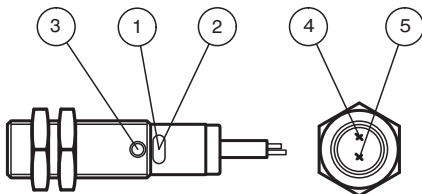



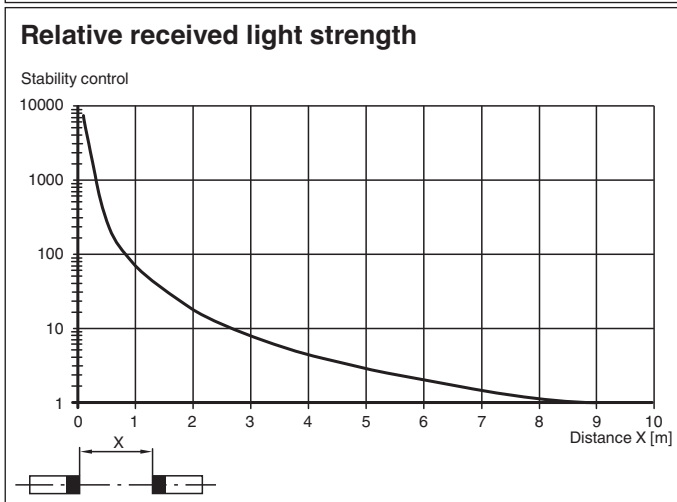
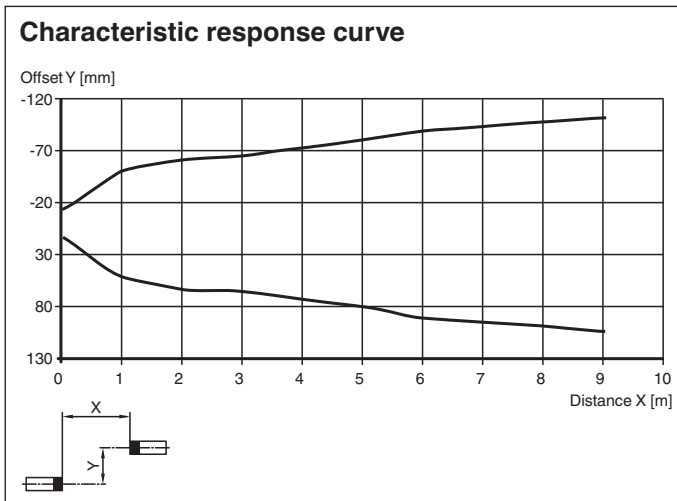

1	Operating display	green
2	Signal display	yellow
3	Potentiometer	
4	Emitter	
5	Receiver	

Characteristic Curve



Accessories

	BF 12	Mounting flange, 12 mm
	BF 12-F	Plastic mounting adapter, 12 mm
	BF 5-30	Universal mounting bracket for cylindrical sensors with a diameter of 5 ... 30 mm
	V1-G-2M-PUR	Female cordset single-ended M12 straight A-coded, 4-pin, PUR cable grey
	V1-W-2M-PUR	Female cordset single-ended M12 angled A-coded, 4-pin, PUR cable grey

Release date: 2023-03-28 Date of issue: 2023-03-28 Filename: 257816_eng.pdf