

# Retroreflective sensor OBR2500-12GM40-E4

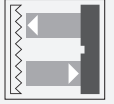

- Robust M12 threaded housing
- Less space required
- Glare protected with polarization filter
- Light-on/dark-on, programmable
- Degree of protection IP67

Retroreflective sensor with polarization filter, M12 threaded housing design, metal housing, front optical face, 5 m detection range, red light, light/dark on, 1 NPN output, fixed cable



## Dimensions

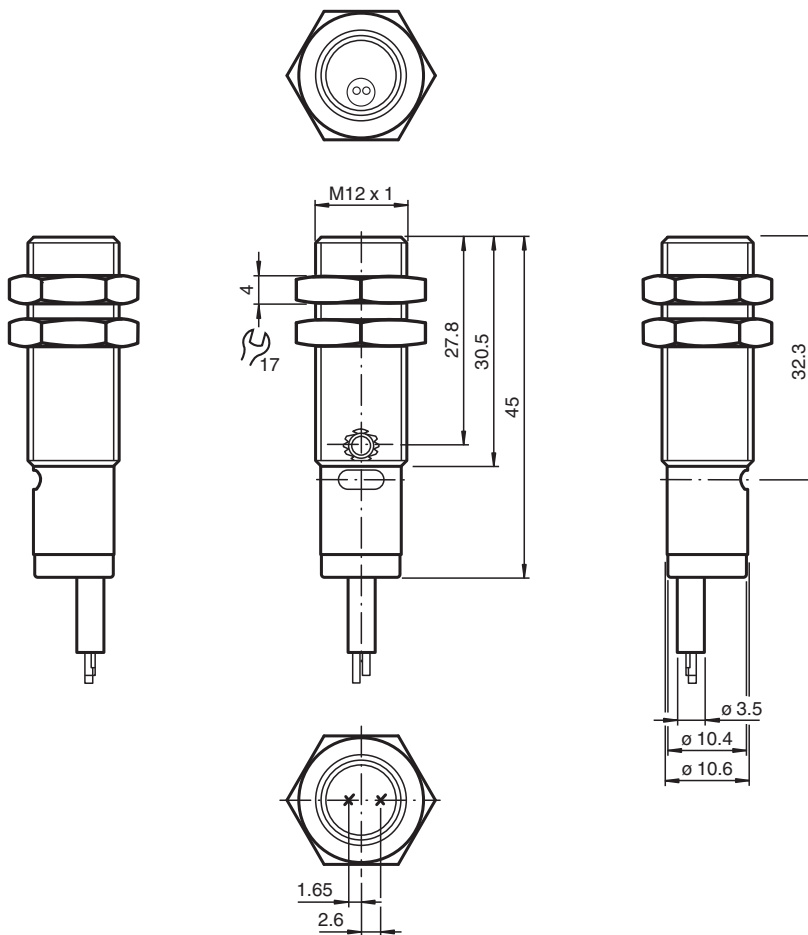

## Technical Data

### General specifications

Effective detection range 0 ... 2500 mm

## Technical Data

Reflector distance		50 ... 2500 mm
Threshold detection range		3000 mm
Reference target		H50 reflector
Light source		LED
Light type		red , 640 nm
Polarization filter		yes
Angle deviation		+/- 2 °
Diameter of the light spot		approx. 150 mm at a distance of 2500 mm
Opening angle		approx. 3.5 °
Optical face		frontal
Ambient light limit		EN 60947-5-2 20000 Lux
<b>Functional safety related parameters</b>		
MTTF <sub>d</sub>		800 a
Mission Time (T <sub>M</sub> )		20 a
Diagnostic Coverage (DC)		0 %
<b>Indicators/operating means</b>		
Operation indicator		LED green: Power on
Function indicator		LED yellow: lights up when receiving the light beam ; flashes when falling short of the operating reserve; OFF when light beam is interrupted
Control elements		sensitivity adjustment
<b>Electrical specifications</b>		
Operating voltage	U <sub>B</sub>	10 ... 30 V DC , class 2
Ripple		10 %
No-load supply current	I <sub>0</sub>	≤ 15 mA
<b>Input</b>		
Control input		light on +UB dark on: 0 V
<b>Output</b>		
Switching type		light/dark on electrically switchable
Signal output		1 NPN output, short-circuit protected, reverse polarity protected, open collector
Switching voltage		max. 30 V DC
Switching current		max. 100 mA , resistive load
Voltage drop	U <sub>d</sub>	≤ 2 V
Switching frequency	f	≤ 1000 Hz
Response time		0.5 ms
<b>Conformity</b>		
Product standard		EN 60947-5-2
<b>Compliance with standards and directives</b>		
Standard conformity		
Standards		UL 508
<b>Approvals and certificates</b>		
UL approval		cULus Listed, Class 2 Power Source, Type 1 enclosure
CCC approval		CCC approval / marking not required for products rated ≤36 V
Approvals		CE, cULus Listed 57M3 (Only in association with UL Class 2 power supply; Type 1 enclosure)
<b>Ambient conditions</b>		
Ambient temperature		-30 ... 60 °C (-22 ... 140 °F)
Storage temperature		-40 ... 70 °C (-40 ... 158 °F)
<b>Mechanical specifications</b>		
Degree of protection		IP67
Connection		2 m fixed cable
Material		
Housing		brass, nickel-plated
Optical face		PMMA

Release date: 2023-04-04 Date of issue: 2023-04-04 Filename: 257817\_eng.pdf

Refer to "General Notes Relating to Pepperl+Fuchs Product Information".

Pepperl+Fuchs Group  
www.pepperl-fuchs.comUSA: +1 330 486 0001  
fa-info@us.pepperl-fuchs.comGermany: +49 621 776 1111  
fa-info@de.pepperl-fuchs.comSingapore: +65 6779 9091  
fa-info@sg.pepperl-fuchs.com

**PEPPERL+FUCHS**

**Technical Data**

Mass	approx. 45 g
Cable length	2 m

**Connection**

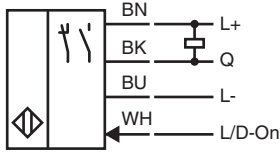

**Assembly**

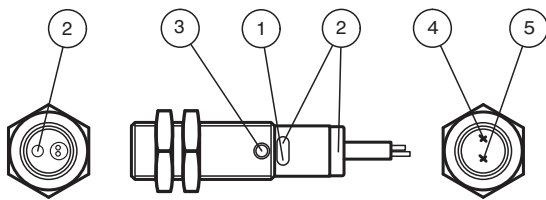

1	Operating display	green
2	Signal display	yellow
3	Potentiometer	
4	Emitter	
5	Receiver	

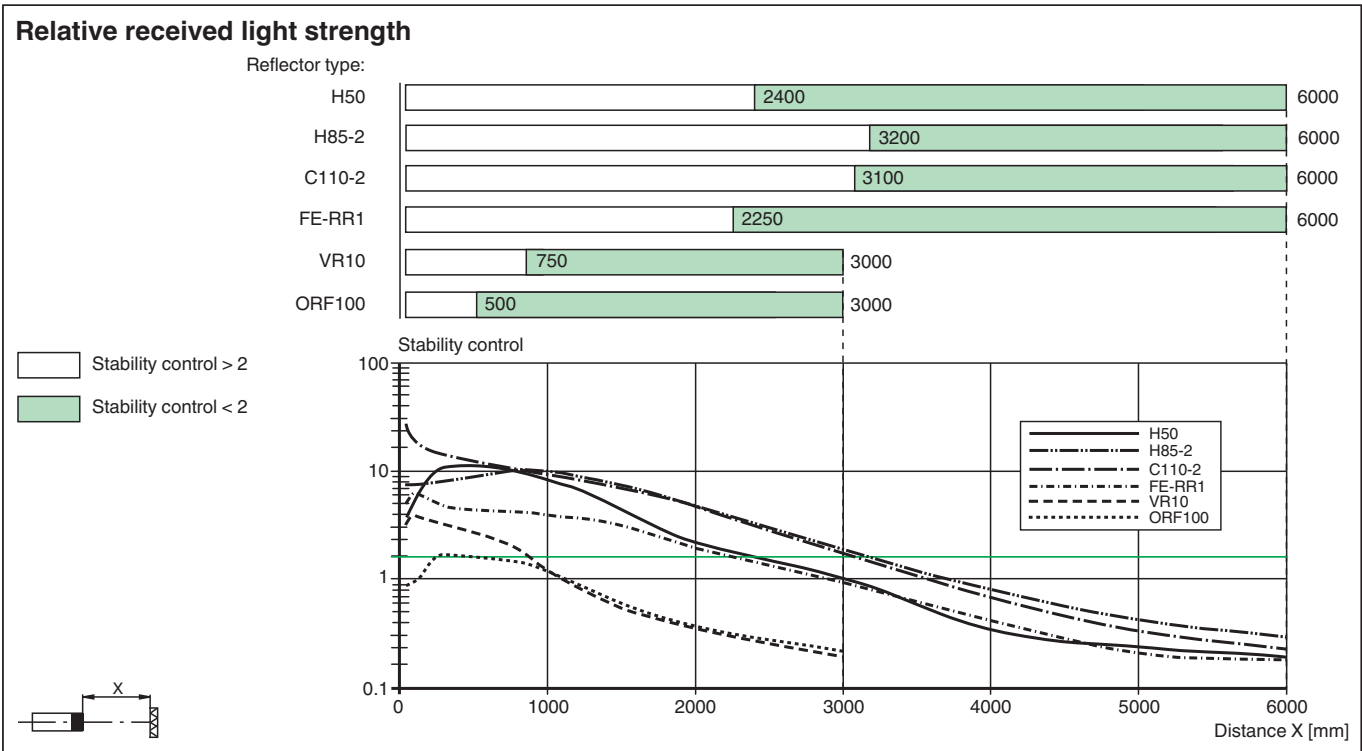







**Accessories**

	<b>BF 12</b>	Mounting flange, 12 mm
	<b>BF 12-F</b>	Plastic mounting adapter, 12 mm

Release date: 2023-04-04 Date of issue: 2023-04-04 Filename: 257817\_eng.pdf

## Accessories

	<b>BF 5-30</b>	Universal mounting bracket for cylindrical sensors with a diameter of 5 ... 30 mm
	<b>REF-H50</b>	Reflector, rectangular 51 mm x 61 mm, mounting holes, fixing strap
	<b>REF-VR10</b>	Reflector, rectangular 60 mm x 19 mm, mounting holes
	<b>REF-H85-2</b>	Reflector, rectangular 84.5 mm x 84.5 mm, mounting holes
	<b>REF-C110-2</b>	Reflector, round $\varnothing$ 84 mm, central mounting hole
	<b>OFR-100/100</b>	Reflective tape 100 mm x 100 mm