

FILE: J:\CUSTDWG\DCA\ DCA020002

INDUCTANCE	LOSSES	WEIGHT
0.21 mH	50 Watts	39 Lbs

NO.	CHANGE DESCRIPTION	BY	DATE	C'K'D
-----	--------------------	----	------	-------

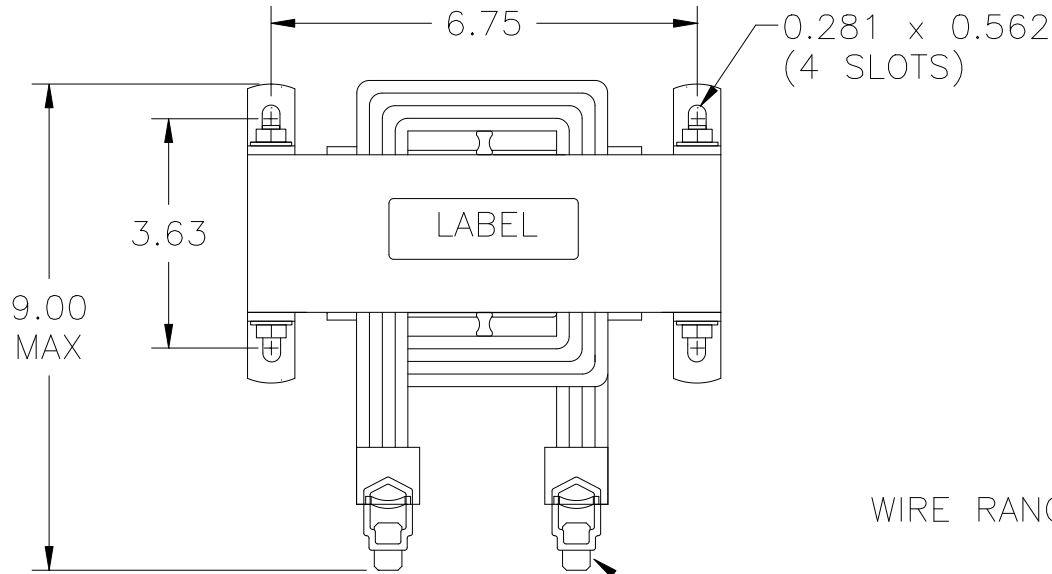

WIRE RANGE: 2-0000 AWG

CAUTION-TERMINAL SCREW TIGHTENING TORQUE: 150 in-lb MAX.

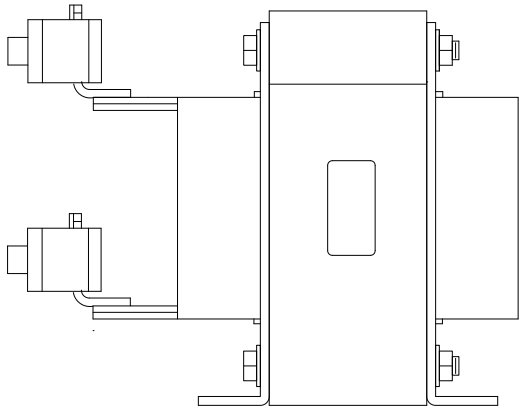
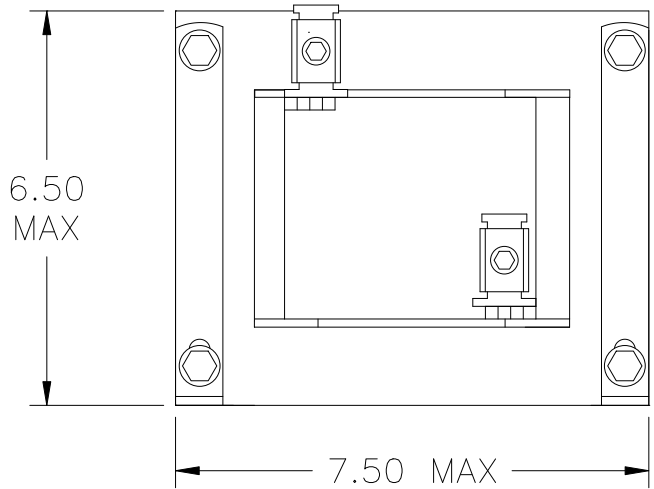

UNLESS OTHERWISE SPECIFIED, DIMENSIONS ARE IN INCHES [mm] AND TOLERANCES ARE:

DECI.	FRAC.
ANGLES	DRILLED HOLES

PART NAME:	DC CHOKE
DESCRIPTION:	OUTLINE DIMENSION
FINISH:	

MTE CORPORATION MENOMONEE FALLS, WISCONSIN			
DCA020002			REV. 00
SCALE	NTS	DATE	06/28/05
REF.	DR. BY	AGK	APP'D