

FILE: J:\CUSTDWG\DCA\DCA000902

INDUCTANCE	LOSSES	WEIGHT
3.22 mH	7 Watts	2 Lbs

NO.	CHANGE DESCRIPTION	BY	DATE	C'K'D
-----	--------------------	----	------	-------

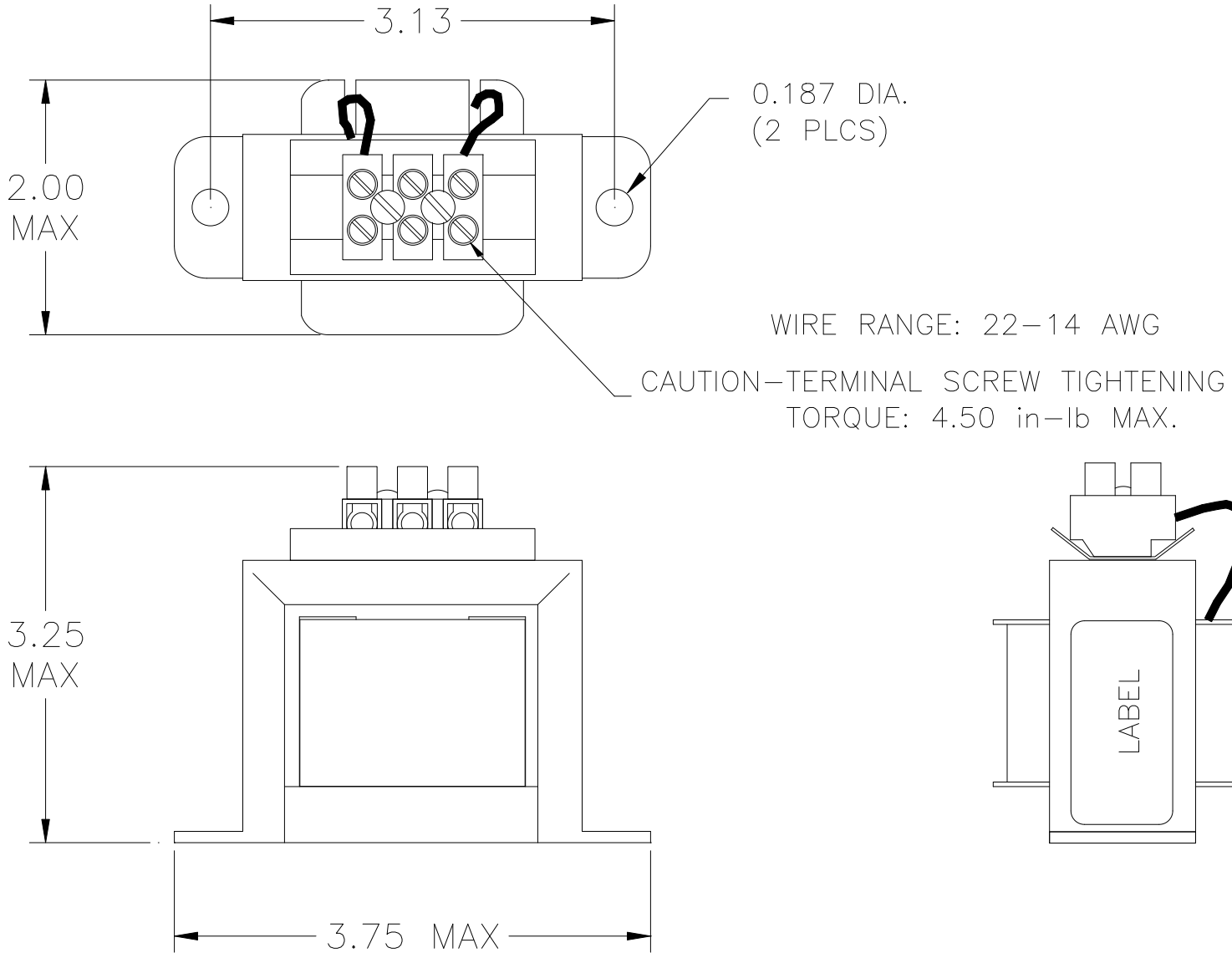

UNLESS OTHERWISE SPECIFIED, DIMENSIONS ARE IN INCHES [mm] AND TOLERANCES ARE:

DECI. FRAC.

ANGLES DRILLED HOLES

PART NAME:	DC CHOKE
DESCRIPTION:	OUTLINE DIMENSION
FINISH:	

MTE CORPORATION MENOMONEE FALLS, WISCONSIN			
DCA000902			REV. 00
SCALE	NTS	DATE	06/28/05
REF.	DR. BY	AGK	C'K'D APP'D