

# GlobalTRAN™



**GlobalTRAN®** products carry the CE mark, certifying 100% compliance with IEC requirements for Non-Short Circuit Proof Isolating Transformers. GlobalTRAN control transformers feature touch-proof terminals, utilizing either Micron's SafeTouch terminal covers or a touch-proof terminal block, and meet true IP-20 or IP-00 terminal protection ratings as defined by IEC-529.

GlobalTRAN is the most reliable and versatile control transformer in the industry today.

- Carries the CE mark
- Epoxy encapsulated coils
- 20-year warranty, double the industry standard
- SafeTouch terminals for additional safety
- Optional integral primary and/or secondary fusing
- 10-32 screw terminals, molded terminal barriers
- Molded-in terminals and phil-slot screws



If you have any questions or we can be of any assistance in helping you determine your transformer requirements, please call our Technical Support Group at:

**1-800-664-4660**

[www.microntransformers.com](http://www.microntransformers.com)

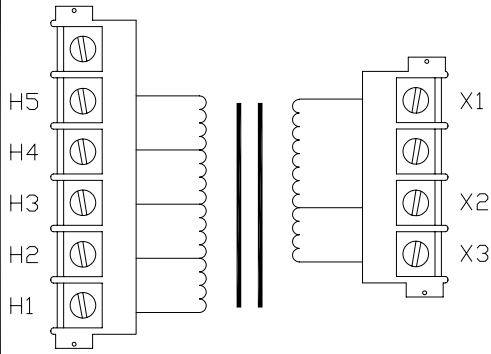

CONNECTION DIAGRAM

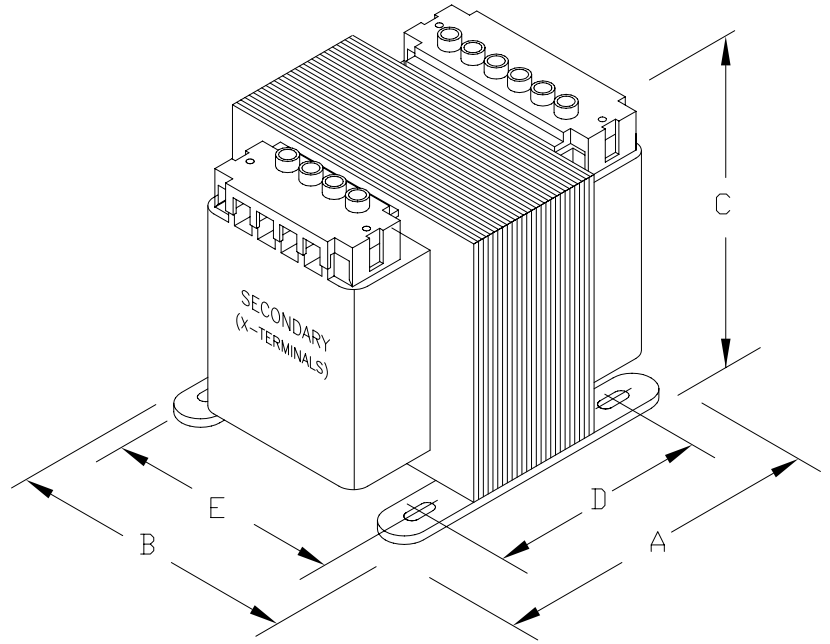

CONNECTION TABLE

INPUT VOLTAGE				OUTPUT VOLTAGE	
H5-H4	H5-H3	H5-H2	H5-H1	X3-X2	X3-X1
220	380	440	550	23	110
230	400	460	575	24	115
240	416	480	600	25	120

PROVIDED WITH SAFE TOUCH TERMINAL COVERS  
NO INTEGRAL FUSING CAPABILITY.

DIMENSIONS							APPROX. WT. LBS (KG)
	A	B	C	D	E	MTG. SLOTS	
INCHES (MM)	5.13 (130)	5.25 (133)	4.50 (114)	3.88 (99)	4.37 (111)	0.313X1.063 (8.0X27.0)	



**MICRON INDUSTRIES CORPORATION**  
777 CHURCH ROAD - ELMHURST, IL 60126  
Tel. (800) 664-4660, (630) 516-1222 Fax (630) 516-1820  
www.MicronTransformers.com

CAT. NO.	<b>B350-2245-GAF</b>		CONST. <b>ENCAPSULATED</b>				UL LISTED
			MODEL <b>GLOBALTRAN</b>				
<b>RATING</b>							SP CERTIFIED
OUTPUT AMPS	14.6/3.0	PRIMARY V	240/416/480/600, 230/400/460/575, 220/380/440/550.		TEMP. CLASS	HZ 50/60	
VA	350	SECONDARY V	25/120, 24/115, 23/110,		130°C	REVISION <b>G</b>	CE IEC 61558