

Top 100  
Global  
Innovator  
for 10 years

# Susol UL MCCB

UL Molded Case Circuit Breakers



**LS** ELECTRIC





**MCCB**

**UTS250L**

**Susol**

**250A 40°C 3P**

**LS**

Wire Size	Terminal
AWG or mm <sup>2</sup>	U <sub>1</sub> -In/Up/Up/Up
16-20 Cu	283.2
13-16 Al/Cu	283.2
20-24 Al/Cu	369.4
25-30 Al	369.4

mm <sup>2</sup>	W m
16 - 70	32
95	33
120-150 Al/Cu	44
185	44

65 / 75°C WIRE  
40°C MACH Typ

**ATU**

**250A 40°C 3P**





# Super Solution for Protection

The new Susol series with thermal-magnetic circuit breakers are designed to protect low voltage electrical systems from damage caused by overloads and short circuits.

## ■ FOR POWER DISTRIBUTION

High breaking capacity  
Optimum coordination technique  
Powerful engineering tools  
Reverse feeding

## ■ FOR PROTECTION OF MOTORS AND THEIR CONTROL DEVICES

Optimal overload protection  
Guaranteed Short Circuit Current Ratings

## ■ FOR CONTROLLING AND DISCONNECTING CIRCUITS

## ■ FOR EXTENSIVE APPLICATIONS

Wide range of optimized auxiliaries and accessories





# Contents

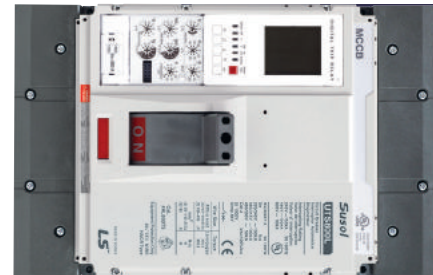





**UTE100 FRAME 15-100 Ampere**

**14 PAGE**

**UTS150 FRAME 40-150 Ampere**

**19 PAGE**

**UTS250 FRAME 150-250 Ampere**

**26 PAGE**

**UTS400 FRAME 250-400 Ampere**

**33 PAGE**

**UTS600 FRAME 500-600 Ampere**

**40 PAGE**

**UTS800 FRAME 400-800 Ampere**

**54 PAGE**

**UTS1200 FRAME 800-1200 Ampere**

**60 PAGE**

**TRIP UNITS**

**66 PAGE**

**DC APPLICATION**

**86 PAGE**

**ACCESSORIES**

**88 PAGE**

**CURVES**

**112 PAGE**

**DIMENSIONS**

**151 PAGE**

Before the installation of the breaker, please read the instruction manual carefully. Please refer to the instruction manual for the correct installation and operation of the breaker. Please refer to the instruction manual for the correct installation and operation of the breaker.



# SUSOL MCCBS AT A GLANCE.

## 1 FOR POWER DISTRIBUTION

- High breaking capacity
- Optimum coordination technique
- Powerful engineering tools
- Reverse feeding

## 2 FOR PROTECTION OF MOTORS AND THEIR CONTROL DEVICES

- Optimal overload protection
- Guaranteed Short Circuit Current Ratings

## 3 FOR EXTENSIVE APPLICATIONS

- Wide range of optimized auxiliaries and accessories

## 4 FOR CONTROLLING AND DISCONNECTING CIRCUITS



UTE100

UTS150

UTS250

UTS400



## SIMPLIFIED PRODUCT RANGE

- **AF:** 100AF, 150AF, 250AF, 400AF, 600AF, 800AF, 1200AF
- **Ampere Range:** 15A ~ 1200A
- **Pole:** 2P, 3P

## VARIABLE ACCESSORIES

- Electrical auxiliaries[AX, AL, UVT, SHT]
- Extended and direct mount rotary handle
- Flange handle with flexible cable and linkage
- Variable depth mechanism
- Locking devices
- LUG for CU/AL cable with UL486
- RCD Unit for UTS250

## HIGH PERFORMANCE

- Ultimate breaking capacity (kA rms)
- Max 100kA @480VAC and 50kA @600V

## STANDARDS

- **World class with UL489**
  - UL489
  - CSA
- **IEC60947-2**
- **Class 1E for Nuclear power plant**
  - EQ : Environment Qualification
  - SQ : Seismic Qualification

## VARIOUS TRIP UNITS

- **ATU:** Adjustable thermal & magnetic unit
- **FMU:** Adjustable thermal, fixed magnetic unit
- **FTU:** Fixed thermal & magnetic unit
- **ETS:** Electronic trip unit (LI, LSI)
- **ETM:** Electronic trip unit (LSIG, Multi-function unit)
- **OCR:** Electronic trip unit

## MCP CHARACTERISTIC

- Simplified product range
  - **AF:** 150AF, 250AF, 400AF, 600AF, 800AF, 1200AF
  - **Ampere Range:** 1.6A ~ 1200A Only 3 Pole use
- **Standards**
  - Instantaneous circuit breaker with UL489
  - Motor protector with MC and Relay with UL508
- **IEC60947-2**

## MCS CHARACTERISTIC

- Simplified product range
  - **AF:** 100AF, 150AF, 250AF, 400AF, 600AF, 800AF, 1200AF
  - **Ampere Range:** 100A ~ 1200A
  - **Pole:** 2P, 3P
- **Standards**
  - World class with UL489
- **IEC60947-2**



UTS600

UTS800

UTS1200

# Engineered for Optimal Protection

## SUSOL SERIES OFFER VARIOUS TRIP UNITS :

- **ATU** (Adjustable thermal & magnetic unit)
- **FMU** (Adjustable thermal, fixed magnetic unit)
- **FTU** (Fixed thermal & magnetic unit)
- **ETS** (Electronic trip unit for UTS150...UTS600)
- **ETM** (Electronic trip unit for UTS400, UTS600)
- **OCR** (Electronic trip unit for UTS800, UTS1200)

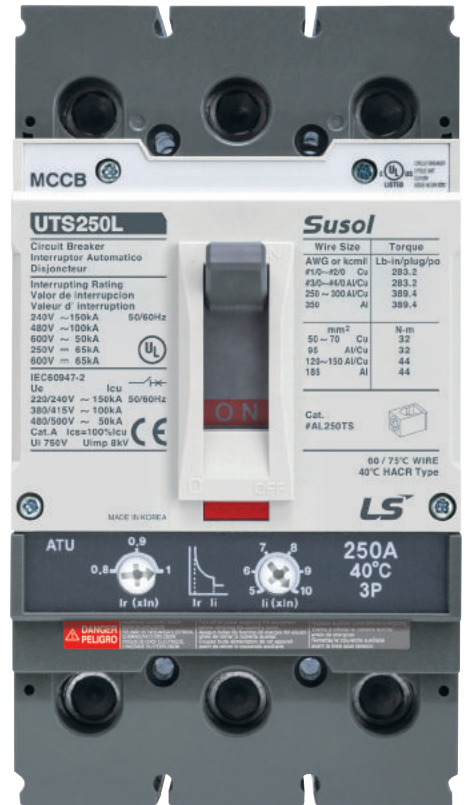

## THERMAL MAGNETIC TRIP UNITS

- UTE100...UTS600 frame
- 15-600 amperes
- Factory-installed
- Several versions by rated current and function

### FTU

- Fixed Thermal. 15A~600A
- Fixed Magnetic. 400A~6000A

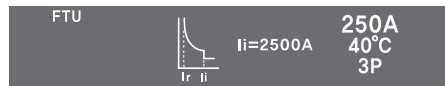

### FMU

- Adjustable Thermal. 25A~600A( 0.8~1 x In)
- Fixed Magnetic. 400A~6000A

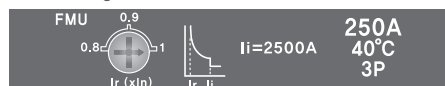

### ATU

- Adjustable Thermal. 100A~600A( 0.8~1 x In)
- Adjustable Magnetic. 500A~6000A(5~10 x In)

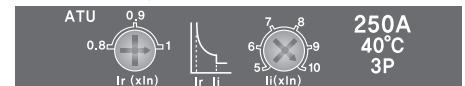

### MCP

- Adjustable Magnetic. 10A~6000A



### MCS

- Fixed Magnetic. 1000A~6000A



## ELECTRONIC TRIP UNITS

- UTS150...UTS600 frame
- 15~600 amperes
- Factory-installed
- Several versions by rated current and function

### ETS

- Electronic trip unit for UTS150...UTS600



### ETM

- Electronic trip unit for UTS400, UTS600

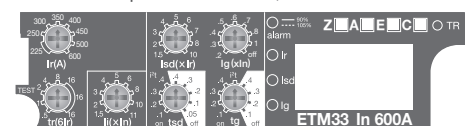



## ELECTRONIC TRIP UNITS

- UTS800, UTS1200 Frame
- 400-1200 Amperes
- Factory-installed internal trip units.
- Several versions by rated current and function

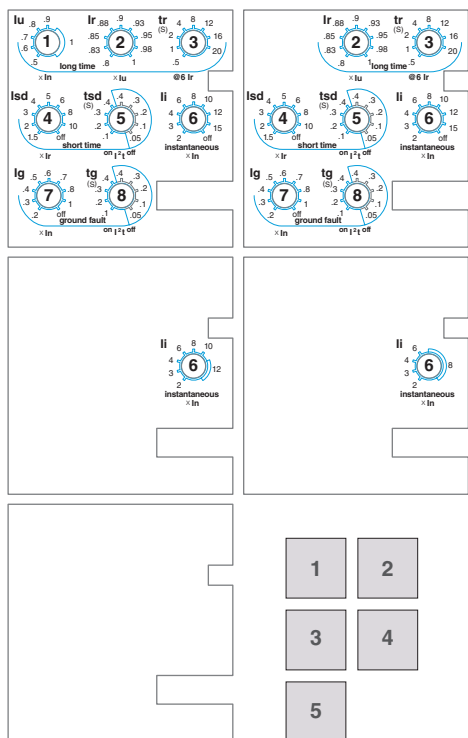

**Susol**  
**UTS800L**  
Circuit Breaker  
Interruptor Automatico  
Disjoncteur

Interrupting Rating  
Valor de Interrupcion  
Valeur d' interruption

240V ~	150kA	50 / 60Hz
480V ~	100kA	
600V ~	50kA	

IEC60947-2 50 / 60Hz  
Ue Icu  
220/240V ~ 150kA  
380/415V ~ 100kA  
480/500V ~ 50kA  
Cat. A Ics=100%Icu  
Ui 1000V  
Uimp 8kV

Wire Size	Torque
AWG or kcmil	Lb-in/lug/pt
(3) #1/0 - 3/0 Al/Cu	388.3
(3) #3/0 - 4/0 Al	388.3
mm <sup>2</sup>	N-m
(3) 95 - 150 Al/Cu	45
(3) 185 Al	45

Cat. #AL800TS

Equipment Protection Only  
60 / 75°C WIRE  
HACR Type

MADE IN KOREA  
**LS**

1. N, A type Knob information
2. P, S type Knob information
3. MCP800 type Knob information
4. MCP1200 type Knob information
5. MCS800/1200 type Knob information

# FUTURING SMART ENERGY

## FOR EXTENSIVE APPLICATIONS

Wide range of optimized auxiliaries and accessories

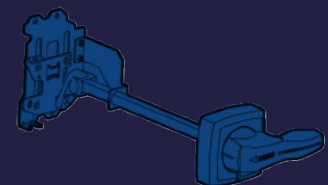
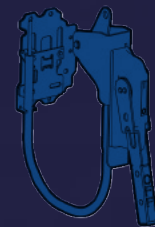
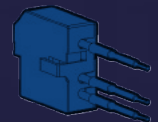
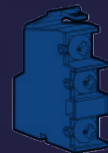
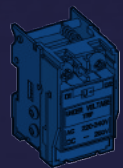
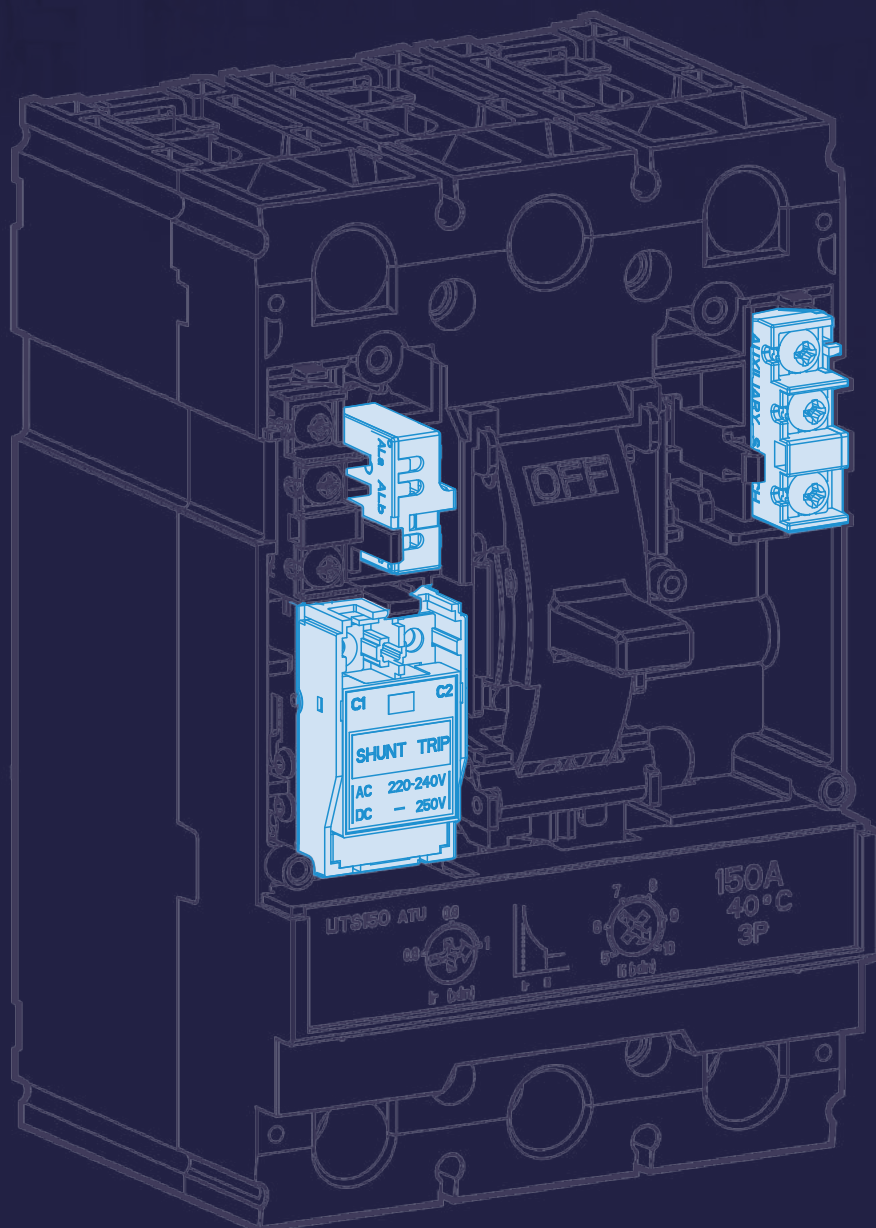



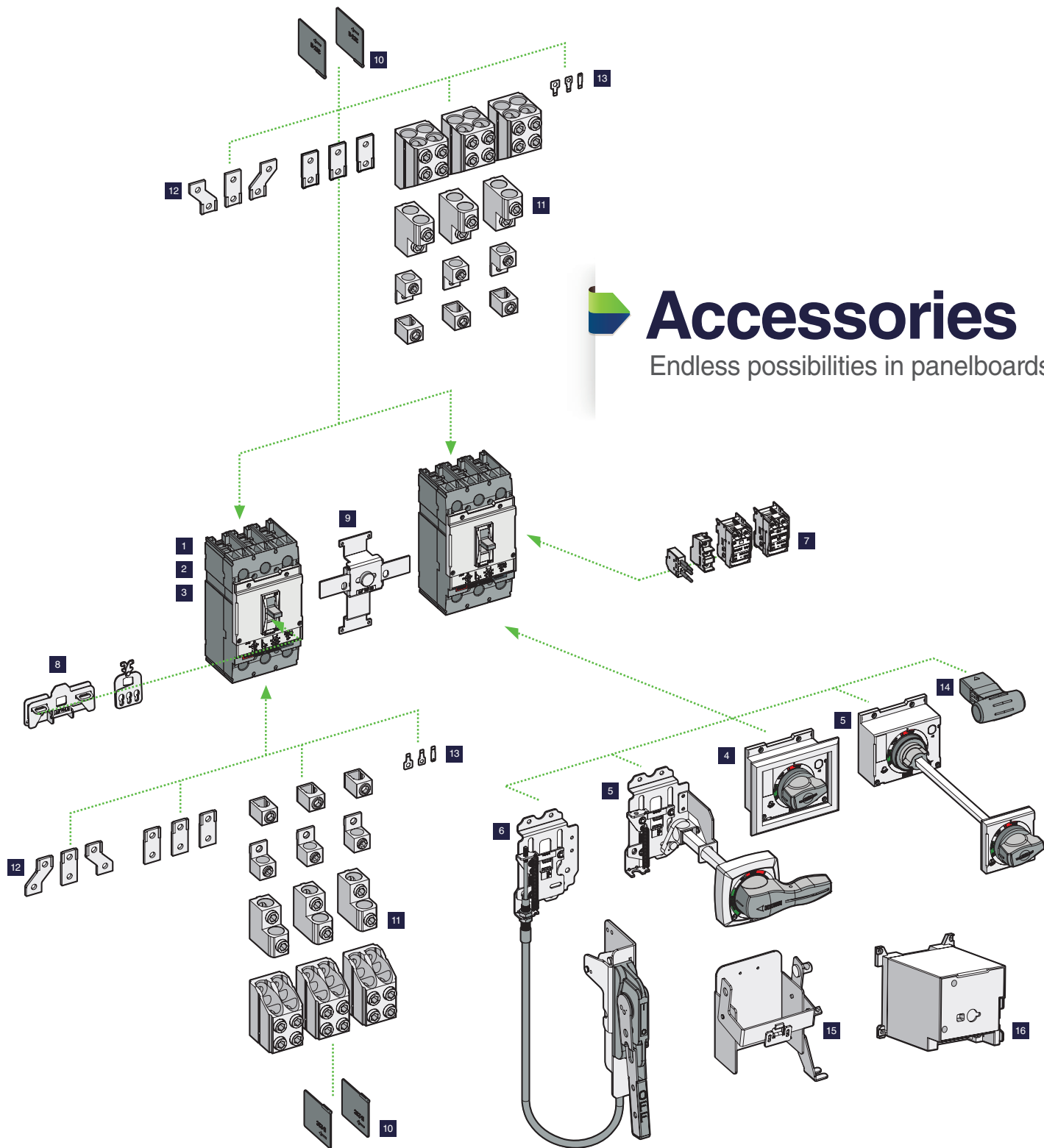

# Accessories

Endless possibilities in panelboards

- 1 Molded Case Circuit Breaker
- 2 Motor Circuit Protector
- 3 Molded Case Switch
- 4 Direct Rotary Handle
- 5 Extended Handle
- 6 Flange Cable Handle

- 7 Inner Accessories (AL, AX, UVT, SHT)
- 8 Locking Device (Handle)
- 9 Mechanical Interlock
- 10 Interphase Barriers
- 11 Mechanical Lugs
- 12 Busbar Connectors

- 13 Control wire Terminal
- 14 Aux. Handle
- 15 Operating Mechanism (VDM/COM)
- 16 Motor operator (MOP)

# Series Overview



Frame	UTE100			UTE100			UTE100			UTS150			
	100A			100A			100A			150A			
Maximum rated current	1			2			3			2, 3			
Number of poles	E	N	H	E	N	H	E	N	H	N	H	L	
Breaker type	UTE100			UTE100			UTE100			UTS150			
UL 489/CSA C22.2	UTE100			UTE100			UTE100			UTS150			
Interrupting capacity (kA rms) AC (50/60HZ)	50	65	100	50	65	100	50	65	100	65	100	150	
UL, CSA, NOM	25	35	65	-	-	-	-	-	-	-	-	-	
	10	14	18	-	-	-	-	-	-	-	-	-	
	-	-	-	25	35	65	25	35	65	35	65	100	
	-	-	-	-	-	-	-	-	-	18	35	50	
	-	-	-	14	18	18(35)	14	18	18(35)	-	-	-	
UL 489 DC	UTE100			UTE100			UTE100			UTS150			
Interrupting capacity (kA) DC	-	-	-	16	25	-	16	25	-	35	50	65	
UL, CSA	-	-	-	-	-	-	25	35	-	-	-	-	
	-	-	-	-	-	-	-	-	-	35	50	65	
IEC 60947-2	UTE100			UTE100			UTE100			UTS150			
Ultimate breaking capacity, (kA rms) AC	50	65	100	50	65	65	50	65	65	65	100	150	
50/60Hz, Icu	-	-	-	25	35	35	25	35	35	35	65	100	
	-	-	-	-	-	-	-	-	-	18	35	50	
Service breaking capacity, Ics (%Icu)	100%			100%			100%			100%			
Insulation voltage, Ui	750 Vac			750 Vac			750 Vac			750 Vac			
Impulse withstand voltage, Uimp	6 kVac			8 kVac			8 kVac			8 kVac			
Rated short-time withstand current (Icw)	-			-			-			-			
Utilization category	A			A			A			A			
TRIP UNITS	15-100A			100A			100A			40-150A			
F : Fixed	ATU *			-			-			•			
A : Adjustable	FMU *			-			•			•			
T : Thermal	FTU *			•			•			•			
M : Magnetic	ETS			-			-			• (60, 100, 150A)			
E : Electronics	ETM			-			-			-			
	MCS **			-			-			-			
	DSU ***			-			-			-			
	OCR			-			-			-			
MCP	Amperes			-			-			1.6-60A			
	MCP			-			-			100-150A			
MCS	Amperes			100A			100A			150A			
	MCS			•			•			•			
Unit mounted	•			•			•			•			
Mechanical lugs	•			•			•			•			
Busbar connectors	•			•			•			•			
Control wire terminal kit	•			•			•			•			
Terminal shields	-			-			-			-			
Interphase barriers	-			•			•			•			
Shunt trip	-			•			•			•			
Undervoltage trip	-			•			•			•			
Auxiliary switch	-			•			•			•			
Alarm switch	-			•			•			•			
Fault alarm switch	-			•			•			•			
Flange cable handle	-			•			•			•			
Flange variable-depth mechanism	-			•			•			•			
Directly-mounted rotary operating handle	-			•			•			•			
NEMA-Door-mounted operating mechanisms	-			•			•			•			
IEC-Door-mounted operating mechanisms	-			•			•			•			
Mechanical interlocks	-			•			•			•			
Handle padlock attachment	•			•			•			•			
Motor operator	-			-			-			•			
Residual Current Device	-			-			-			-			
Weight(approximate)	1-Pole			0.96 (0.435)			-			-			
lbs.(kg)	2-Pole			-			1.64(0.74)			3.44(1.56)			
	3-Pole			-			-			3.95(1.79)			
Dimensions	W x H x D	W	H	D	W	H	D	W	H	D	W	H	D
Inches(mm)	1-Pole	1.02(26)	5.12(130)	3.44(87.5)	-	-	-	-	-	-	-	-	-
	2-Pole	-	-	-	2.01(51)	5.12(130)	3.44(87.5)	-	-	-	4.13(105)	6.50(165)	3.44(87.5)
	3-Pole	-	-	-	-	-	-	2.99(76)	5.12(130)	3.44(87.5)	4.13(105)	6.50(165)	3.44(87.5)



UTS250		
250A		
2, 3		
N	H	L
UTS250		
65	100	150
-	-	-
35	65	100
18	35	50
-	-	-

UTS400		
400A		
2, 3		
N	H	L
UTS400		
65	100	150
-	-	-
35	65	100
18	35	50
-	-	-

UTS600		
600A		
2, 3		
N	H	L
UTS600		
65	100	150
-	-	-
35	65	100
18	35	50
-	-	-

UTS800		
800A		
3		
N	H	L
UTS800		
50	100	150
-	-	-
35	65	100
18	35	50
-	-	-

UTS1200			
1200A			
3			
N	H	P	L
UTS1200			
50	100	65	150
-	-	-	-
35	65	50	100
18	25	50	35
-	-	-	-

35	50	65
-	-	-
35	50	65

35	50	65
-	-	-
35	50	65

35	50	65
-	-	-
35	50	65

-	-	-
-	-	-
-	-	-

-	-	-	-
-	-	-	-
-	-	-	-

65	100	150
35	65	100
18	35	50

65	100	150
35	65	100
18	35	50

65	100	150
35	65	100
18	35	50

65	100	150
35	65	100
18	35	50

50	100	65	150
35	65	50	100
25	35	50	50

100%		
750 Vac		
8 kVac		
-		

100%		
750 Vac		
8 kVac		
-		

100%		
750 Vac		
8 kVac		
-		

100%		
1000 Vac		
8 kVac		
-		
18kA	-	-

100%			
1000 Vac			
8 kVac			
-			
25kA	-	25kA	-

A		
150~250A		
•		
•		

A		
250/300/350/400A		
•		
•		

A		
500/600A		
•		
•		

A		
400/600/630/800A		
•		
•		

A			
800/1000/1200A			
•			
•			

• (150, 250A)		
-		
-		
-		

• (250, 400A)		
• (250, 400A)		
-		
-		

• (400, 600A)		
• (400, 600A)		
-		
-		

-		
-		
-		
-		

-			
-			
-			
-			

-		
-		
-		
-		

-		
-		
-		
-		

-		
-		
-		
-		

-		
-		
-		
-		

-			
-			
-			
-			

220A		
•		
250A		
•		
•		

320A		
•		
400A		
•		
•		

500A		
•		
600A		
•		
•		

800A		
•		
800A		
•		
•		

1200A			
•			
1200A			
•			
•			

•		
•		
•		
•		
•		

•		
•		
•		
•		
•		

•		
•		
•		
•		
•		

•		
•		
•		
•		
•		

•			
•			
•			
•			
•			

•		
•		
•		
•		
•		

•		
•		
•		
•		
•		

•		
•		
•		
•		
•		

•		
•		
•		
•		
•		

•			
•			
•			
•			
•			

•		
•		
•		
•		
•		

•		
•		
•		
•		
•		

•		
•		
•		
•		
•		

•		
•		
•		
•		
•		

•			
•			
•			
•			
•			

•		
•		
•		
•		
•		

•		
•		
•		
•		
•		

•		
•		
•		
•		
•		

•		
•		
•		
•		
•		

•			
•			
•			
•			
•			

-		
-		
-		
-		

-		
-		
-		
-		

-		
-		
-		
-		

-		
-		
-		
-		

-			
-			
-			
-			

3.88(1.76)		
4.49(2.04)		
-		

12.02(5.45)		
13.89(6.30)		
-		

13.45(6.10)		
15.79(7.16)		
-		

-		
31.35(14.22)		
-		

-			
40.28(18.27)			
-			

W	H	D
-	-	-
4.13(105)	748(190)	3.44(87.5)
4.13(105)	748(190)	3.44(87.5)

W	H	D
-	-	-
5.51(140)	1142(290)	4.33(110)
5.51(140)	1142(290)	4.33(110)

W	H	D
-	-	-
5.51(140)	1339(340)	4.33(110)
5.51(140)	1339(340)	4.33(110)

W	H	D
-	-	-
8.27(210)	1288(3272)	6(152.5)
8.27(210)	1288(3272)	6(152.5)

W	H	D
-	-	-
8.27(210)	1626(413)	6(152.5)
8.27(210)	1626(413)	6(152.5)



# SELECTION GUIDE

# UTE100



## CATALOG NUMBERING [PRODUCT SELECTION]

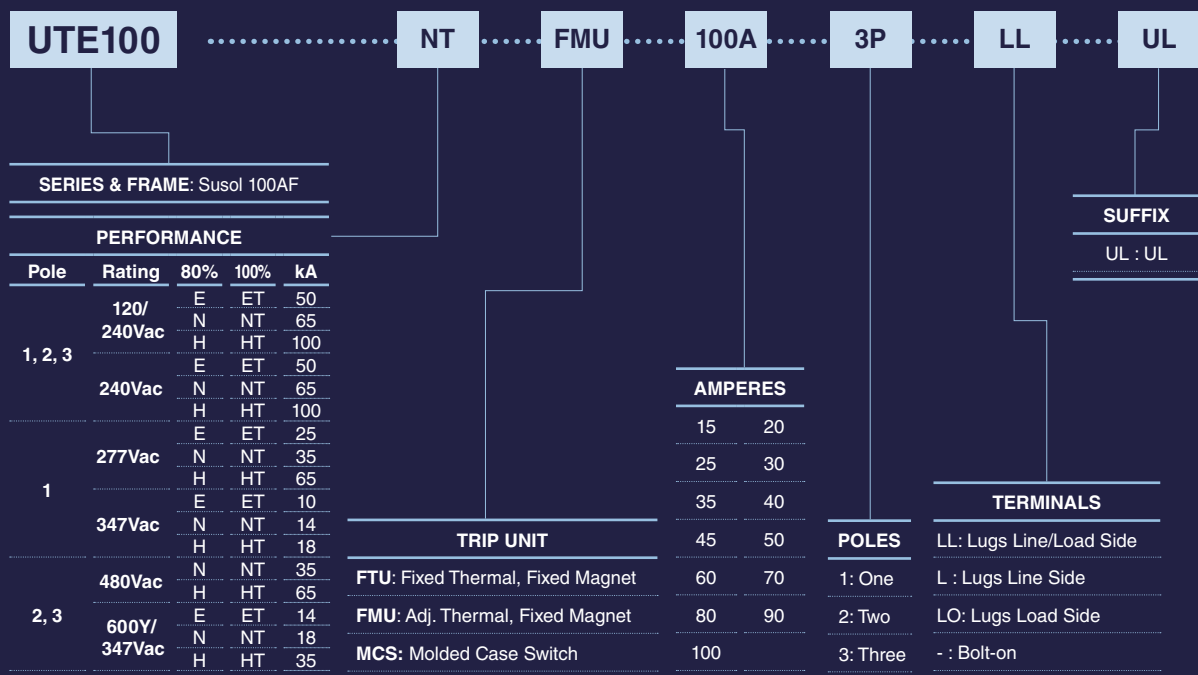

## UTE100 FRAME

- UTE100 breaker is HACR rated
- SWD switch duty rating  
(applied only to 15 and 20A /347Vac or less)
- HID high intensity discharge lighting rating  
(15~50A /480Vac or less)

### UL489 RATINGS

BREAKER TYPE	NUMBER OF POLES	INTERRUPTING CAPACITY (kA rms) AC 50/60Hz						INTERRUPTING CAPACITY (kA) DC	
		120/240V	240V	277V	480V	347V	600Y 347V	250V DC-2P	500V DC-3P
UTE100E	1	50	50	25	-	10	-	-	-
	2, 3	50	50	-	25	-	14	16	25
UTE100N	1	65	65	35	-	14	-	-	-
	2, 3	65	65	-	35	-	18	25	35
UTE100H	1	100	100	65	-	18	-	-	-
	2, 3	100	100	-	65	-	35	-	-

### IEC60947-2 RATINGS

BREAKER TYPE	NUMBER OF POLES	INTERRUPTING CAPACITY(kA rms) AC 50/60Hz, Icu	
		220/240V	380/415V
UTE100E	1	50	-
	2, 3	50	25
UTE100N	1	65	-
	2, 3	65	35
UTE100H	1	100	-
	2, 3	65	35

Service breaking capacity, Ics (%Icu) 100%

Insulation Voltage, Ui 750 Vac

Impulse Withstand Voltage, Uimp 1-Pole: 6k Vac  
2/3-Pole: 8k Vac

Utilization Category A

### DIMENSIONS

POLES	DIMENSIONS inch (mm)		
	W	H	D
1-Pole	1.02 (26)	5.12 (130)	3.44 (87.5)
2-Pole	2.01 (51)	5.12 (130)	3.44 (87.5)
3-Pole	2.99 (76)	5.12 (130)	3.44 (87.5)

### TRIP UNIT TYPES

	THERMAL	MAGNETIC	REMARKS
FTU	Fixed	Fixed	
FMU	Adjustable, 0.8~1 x In	Fixed	
MCS	N.A	Fixed, 10 x In	Magnetic only

### CIRCUIT BREAKER

WITH FTU TRIP UNIT (FIXED THERMAL, FIXED MAGNETIC)									
Ampere Rating, In	50kA at 120Vac, 50kA at 240Vac			65kA at 120Vac, 65kA at 240Vac			100kA at 120Vac, 100kA at 240Vac		
	1-Pole	2-Pole	3-Pole	1-Pole	2-Pole	3-Pole	1-Pole	2-Pole	3-Pole
15A	UTE100-E-FTU-15-1	UTE100-E-FTU-15-2	UTE100-E-FTU-15-3	UTE100-N-FTU-15-1	UTE100-N-FTU-15-2	UTE100-N-FTU-15-3	UTE100-H-FTU-15-1	UTE100-H-FTU-15-2	UTE100-H-FTU-15-3
20A	UTE100-E-FTU-20-1	UTE100-E-FTU-20-2	UTE100-E-FTU-20-3	UTE100-N-FTU-20-1	UTE100-N-FTU-20-2	UTE100-N-FTU-20-3	UTE100-H-FTU-20-1	UTE100-H-FTU-20-2	UTE100-H-FTU-20-3
25A	UTE100-E-FTU-25-1	UTE100-E-FTU-25-2	UTE100-E-FTU-25-3	UTE100-N-FTU-25-1	UTE100-N-FTU-25-2	UTE100-N-FTU-25-3	UTE100-H-FTU-25-1	UTE100-H-FTU-25-2	UTE100-H-FTU-25-3
30A	UTE100-E-FTU-30-1	UTE100-E-FTU-30-2	UTE100-E-FTU-30-3	UTE100-N-FTU-30-1	UTE100-N-FTU-30-2	UTE100-N-FTU-30-3	UTE100-H-FTU-30-1	UTE100-H-FTU-30-2	UTE100-H-FTU-30-3
35A	UTE100-E-FTU-35-1	UTE100-E-FTU-35-2	UTE100-E-FTU-35-3	UTE100-N-FTU-35-1	UTE100-N-FTU-35-2	UTE100-N-FTU-35-3	UTE100-H-FTU-35-1	UTE100-H-FTU-35-2	UTE100-H-FTU-35-3
40A	UTE100-E-FTU-40-1	UTE100-E-FTU-40-2	UTE100-E-FTU-40-3	UTE100-N-FTU-40-1	UTE100-N-FTU-40-2	UTE100-N-FTU-40-3	UTE100-H-FTU-40-1	UTE100-H-FTU-40-2	UTE100-H-FTU-40-3
45A	UTE100-E-FTU-45-1	UTE100-E-FTU-45-2	UTE100-E-FTU-45-3	UTE100-N-FTU-45-1	UTE100-N-FTU-45-2	UTE100-N-FTU-45-3	UTE100-H-FTU-45-1	UTE100-H-FTU-45-2	UTE100-H-FTU-45-3
50A	UTE100-E-FTU-50-1	UTE100-E-FTU-50-2	UTE100-E-FTU-50-3	UTE100-N-FTU-50-1	UTE100-N-FTU-50-2	UTE100-N-FTU-50-3	UTE100-H-FTU-50-1	UTE100-H-FTU-50-2	UTE100-H-FTU-50-3
60A	UTE100-E-FTU-60-1	UTE100-E-FTU-60-2	UTE100-E-FTU-60-3	UTE100-N-FTU-60-1	UTE100-N-FTU-60-2	UTE100-N-FTU-60-3	UTE100-H-FTU-60-1	UTE100-H-FTU-60-2	UTE100-H-FTU-60-3
70A	UTE100-E-FTU-70-1	UTE100-E-FTU-70-2	UTE100-E-FTU-70-3	UTE100-N-FTU-70-1	UTE100-N-FTU-70-2	UTE100-N-FTU-70-3	UTE100-H-FTU-70-1	UTE100-H-FTU-70-2	UTE100-H-FTU-70-3
80A	UTE100-E-FTU-80-1	UTE100-E-FTU-80-2	UTE100-E-FTU-80-3	UTE100-N-FTU-80-1	UTE100-N-FTU-80-2	UTE100-N-FTU-80-3	UTE100-H-FTU-80-1	UTE100-H-FTU-80-2	UTE100-H-FTU-80-3
90A	UTE100-E-FTU-90-1	UTE100-E-FTU-90-2	UTE100-E-FTU-90-3	UTE100-N-FTU-90-1	UTE100-N-FTU-90-2	UTE100-N-FTU-90-3	UTE100-H-FTU-90-1	UTE100-H-FTU-90-2	UTE100-H-FTU-90-3
100A	UTE100-E-FTU-100-1	UTE100-E-FTU-100-2	UTE100-E-FTU-100-3	UTE100-N-FTU-100-1	UTE100-N-FTU-100-2	UTE100-N-FTU-100-3	UTE100-H-FTU-100-1	UTE100-H-FTU-100-2	UTE100-H-FTU-100-3

# UTE100 FRAME

## CIRCUIT BREAKER

WITH FTU TRIP UNIT (FIXED THERMAL, FIXED MAGNETIC)						
Ampere Rating, In	25kA at 277Vac	35kA at 277Vac	65kA at 277Vac	10kA at 347Vac	14kA at 347Vac	18kA at 347Vac
	1-Pole	1-Pole	1-Pole	1-Pole	1-Pole	1-Pole
15A	UTE100-E-FTU-15-1	UTE100-N-FTU-15-1	UTE100-H-FTU-15-1	UTE100-E-FTU-15-1	UTE100-N-FTU-15-1	UTE100-H-FTU-15-1
20A	UTE100-E-FTU-20-1	UTE100-N-FTU-20-1	UTE100-H-FTU-20-1	UTE100-E-FTU-20-1	UTE100-N-FTU-20-1	UTE100-H-FTU-20-1
25A	UTE100-E-FTU-25-1	UTE100-N-FTU-25-1	UTE100-H-FTU-25-1	UTE100-E-FTU-25-1	UTE100-N-FTU-25-1	UTE100-H-FTU-25-1
30A	UTE100-E-FTU-30-1	UTE100-N-FTU-30-1	UTE100-H-FTU-30-1	UTE100-E-FTU-30-1	UTE100-N-FTU-30-1	UTE100-H-FTU-30-1
35A	UTE100-E-FTU-35-1	UTE100-N-FTU-35-1	UTE100-H-FTU-35-1	UTE100-E-FTU-35-1	UTE100-N-FTU-35-1	UTE100-H-FTU-35-1
40A	UTE100-E-FTU-40-1	UTE100-N-FTU-40-1	UTE100-H-FTU-40-1	UTE100-E-FTU-40-1	UTE100-N-FTU-40-1	UTE100-H-FTU-40-1
45A	UTE100-E-FTU-45-1	UTE100-N-FTU-45-1	UTE100-H-FTU-45-1	UTE100-E-FTU-45-1	UTE100-N-FTU-45-1	UTE100-H-FTU-45-1
50A	UTE100-E-FTU-50-1	UTE100-N-FTU-50-1	UTE100-H-FTU-50-1	UTE100-E-FTU-50-1	UTE100-N-FTU-50-1	UTE100-H-FTU-50-1
60A	UTE100-E-FTU-60-1	UTE100-N-FTU-60-1	UTE100-H-FTU-60-1	UTE100-E-FTU-60-1	UTE100-N-FTU-60-1	UTE100-H-FTU-60-1
70A	UTE100-E-FTU-70-1	UTE100-N-FTU-70-1	UTE100-H-FTU-70-1	UTE100-E-FTU-70-1	UTE100-N-FTU-70-1	UTE100-H-FTU-70-1
80A	UTE100-E-FTU-80-1	UTE100-N-FTU-80-1	UTE100-H-FTU-80-1	UTE100-E-FTU-80-1	UTE100-N-FTU-80-1	UTE100-H-FTU-80-1
90A	UTE100-E-FTU-90-1	UTE100-N-FTU-90-1	UTE100-H-FTU-90-1	UTE100-E-FTU-90-1	UTE100-N-FTU-90-1	UTE100-H-FTU-90-1
100A	UTE100-E-FTU-100-1	UTE100-N-FTU-100-1	UTE100-H-FTU-100-1	UTE100-E-FTU-100-1	UTE100-N-FTU-100-1	UTE100-H-FTU-100-1

WITH FTU TRIP UNIT (FIXED THERMAL, FIXED MAGNETIC)						
Ampere Rating, In	25kA at 480V, 14kA at 600Y 347Vac		35kA at 480V, 18kA at 600Y 347Vac		65kA at 480V, 35kA at 600Y/347Vac	
	2-Pole	3-Pole	2-Pole	3-Pole	2-Pole	3-Pole
15A	UTE100-E-FTU-15-2	UTE100-E-FTU-15-3	UTE100-N-FTU-15-2	UTE100-N-FTU-15-3	UTE100-H-FTU-15-2	UTE100-H-FTU-15-3
20A	UTE100-E-FTU-20-2	UTE100-E-FTU-20-3	UTE100-N-FTU-20-2	UTE100-N-FTU-20-3	UTE100-H-FTU-20-2	UTE100-H-FTU-20-3
25A	UTE100-E-FTU-25-2	UTE100-E-FTU-25-3	UTE100-N-FTU-25-2	UTE100-N-FTU-25-3	UTE100-H-FTU-25-2	UTE100-H-FTU-25-3
30A	UTE100-E-FTU-30-2	UTE100-E-FTU-30-3	UTE100-N-FTU-30-2	UTE100-N-FTU-30-3	UTE100-H-FTU-30-2	UTE100-H-FTU-30-3
35A	UTE100-E-FTU-35-2	UTE100-E-FTU-35-3	UTE100-N-FTU-35-2	UTE100-N-FTU-35-3	UTE100-H-FTU-35-2	UTE100-H-FTU-35-3
40A	UTE100-E-FTU-40-2	UTE100-E-FTU-40-3	UTE100-N-FTU-40-2	UTE100-N-FTU-40-3	UTE100-H-FTU-40-2	UTE100-H-FTU-40-3
45A	UTE100-E-FTU-45-2	UTE100-E-FTU-45-3	UTE100-N-FTU-45-2	UTE100-N-FTU-45-3	UTE100-H-FTU-45-2	UTE100-H-FTU-45-3
50A	UTE100-E-FTU-50-2	UTE100-E-FTU-50-3	UTE100-N-FTU-50-2	UTE100-N-FTU-50-3	UTE100-H-FTU-50-2	UTE100-H-FTU-50-3
60A	UTE100-E-FTU-60-2	UTE100-E-FTU-60-3	UTE100-N-FTU-60-2	UTE100-N-FTU-60-3	UTE100-H-FTU-60-2	UTE100-H-FTU-60-3
70A	UTE100-E-FTU-70-2	UTE100-E-FTU-70-3	UTE100-N-FTU-70-2	UTE100-N-FTU-70-3	UTE100-H-FTU-70-2	UTE100-H-FTU-70-3
80A	UTE100-E-FTU-80-2	UTE100-E-FTU-80-3	UTE100-N-FTU-80-2	UTE100-N-FTU-80-3	UTE100-H-FTU-80-2	UTE100-H-FTU-80-3
90A	UTE100-E-FTU-90-2	UTE100-E-FTU-90-3	UTE100-N-FTU-90-2	UTE100-N-FTU-90-3	UTE100-H-FTU-90-2	UTE100-H-FTU-90-3
100A	UTE100-E-FTU-100-2	UTE100-E-FTU-100-3	UTE100-N-FTU-100-2	UTE100-N-FTU-100-3	UTE100-H-FTU-100-2	UTE100-H-FTU-100-3

WITH FMU TRIP UNIT (ADJUSTABLE THERMAL, FIXED MAGNETIC)				
Ampere Rating, In	50kA at 120/240V, 50kA at 240Vac	65kA at 120/240V, 65kA at 240Vac	100kA at 120/240V, 100kA at 240Vac	Thermal range
	3-Pole	3-Pole	3-Pole	
25A	UTE100-E-FMU-25-3	UTE100-N-FMU-25-3	UTE100-H-FMU-25-3	20-25A
40A	UTE100-E-FMU-40-3	UTE100-N-FMU-40-3	UTE100-H-FMU-40-3	32-40A
60A	UTE100-E-FMU-60-3	UTE100-N-FMU-60-3	UTE100-H-FMU-60-3	48-60A
80A	UTE100-E-FMU-80-3	UTE100-N-FMU-80-3	UTE100-H-FMU-80-3	64-80A
100A	UTE100-E-FMU-100-3	UTE100-N-FMU-100-3	UTE100-H-FMU-100-3	80-100A

WITH FMU TRIP UNIT (ADJUSTABLE THERMAL, FIXED MAGNETIC)				
Ampere Rating, In	25kA at 480V, 14kA at 600Y 347Vac	35kA at 480V, 18kA at 600Y 347Vac	65kA at 480V, 35kA at 600Y/347Vac	Thermal range
	3-Pole	3-Pole	3-Pole	
25A	UTE100-E-FMU-25-3	UTE100-N-FMU-25-3	UTE100-H-FMU-25-3	20-25A
40A	UTE100-E-FMU-40-3	UTE100-N-FMU-40-3	UTE100-H-FMU-40-3	32-40A
60A	UTE100-E-FMU-60-3	UTE100-N-FMU-60-3	UTE100-H-FMU-60-3	48-60A
80A	UTE100-E-FMU-80-3	UTE100-N-FMU-80-3	UTE100-H-FMU-80-3	64-80A
100A	UTE100-E-FMU-100-3	UTE100-N-FMU-100-3	UTE100-H-FMU-100-3	80-100A

## MOLDED CASE SWITCH

WITH MCS TRIP UNIT				
Ampere Rating, In	50kA at 120/240V, 50kA at 240Vac		65kA at 120/240V, 65kA at 240Vac	
	2-Pole	3-Pole	2-Pole	3-Pole
100A	UTE100-E-MCS-100-2	UTE100-E-MCS-100-3	UTE100-N-MCS-100-2	UTE100-N-MCS-100-3

Ampere Rating, In	25kA at 480V, 14kA at 600Y 347Vac		35kA at 480V, 18kA at 600Y 347Vac	
	2-Pole	3-Pole	2-Pole	3-Pole
100A	UTE100-E-MCS-100-2	UTE100-E-MCS-100-3	UTE100-N-MCS-100-2	UTE100-N-MCS-100-3



## ACCESSORIES FOR UTE100

### MECHANICAL LUGS

MAXIMUM BREAKER AMPERES	TERMINAL BODY MATERIAL	WIRE TYPE	ORDERING TYPE
100A	Aluminum	Cu/Al	AL100TE

AL100TE 15-100A Lug

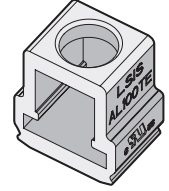

### INNER ACCESSORIES

DESCRIPTION	CONTROL VOLTAGE	ORDERING TYPE *
Auxiliary Switch, AX		
Alarm Switch, AL		
AX + AL		
Shunt Trip, SHT	AC/DC 12V	TBT
	DC 12V	LWT
	AC/DC 24V	TBT
	AC/DC 24~30V	LWT
	AC/DC 48V	TBT
	AC/DC 60V	TBT
	AC/DC 48~60V	LWT
	AC/DC 100~130V	TBT, LWT
	AC/DC 200~250V	TBT, LWT
	AC 380~450V	TBT, LWT
Undervoltage Trip, UVT	AC 440~500V	TBT, LWT
	AC/DC 24V	
	AC/DC 48V	
	AC/DC 100~110V	
	AC/DC 200~220V	
	AC 380~440V	
	AC 440~480V	

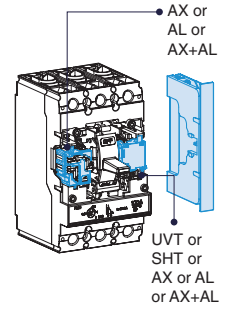

Type	Left(R)	Right(T)
AX	1	1
AL	1	1
AX+AL	1	1
SHT		1
UVT		1

- Applicable in indicated pole position-not synchronous  
- 2P : Right only

\* TBT(Terminal Block Type), LWT(Lead Wire Type)

### PADLOCKING DEVICE

DESCRIPTION	ORDERING TYPE
Lock in "OFF" position	PL0



<Pad Lock>

### PLATE HANDLE LOCKING DEVICE

DESCRIPTION	ORDERING TYPE
Lock in "OFF" or "ON" position	PHL0



<Plate Handle Lock>

### MECHANICAL INTERLOCKING DEVICE

DESCRIPTION	ORDERING TYPE
For 3-Pole breaker	MIT03



<Mechanical Interlock>

### ENCLOSURE

ENCLOSURE DIMENSION (W X H X D) inch(mm)	ORDERING TYPE
8.27(210) x 17.3(439.4) x 4.0(101.6)	-

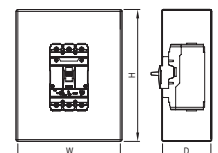

## ACCESSORIES FOR UTE100

### ROTARY OPERATING HANDLES

DESCRIPTION	TYPE	ORDERING TYPE
Directly Mounted	NEMA Type 1	DH-0
Extended (Door-Mounted)	NEMA Type 1	REH-0
	NEMA Type 1	REH-0C
NEMA Door-Mounted	NEMA Type 1, 12	EHU-0
	NEMA Type 3, 3R, 4	EHV-0
	NEMA Type 3, 4, 4X	EHX-0
	NEMA Type 1, 12	EHU-0C
	NEMA Type 3, 3R, 4	EHV-0C
	NEMA Type 3, 4, 4X	EHX-0C

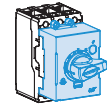

<DH-0>

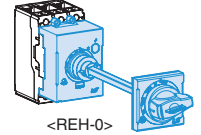

<REH-0>

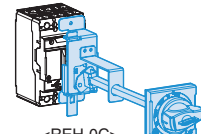

<EHU-0C>

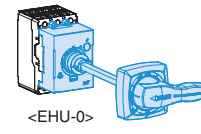

<EHU-0>

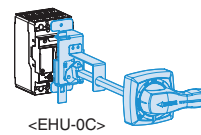

<EHU-0C>

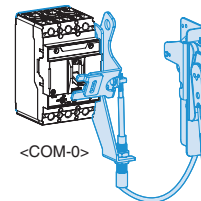

<VDM-0>

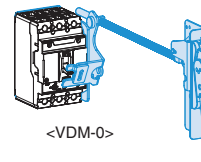

<VDM-0>

### FLANGE HANDLES WITH CABLE OPERATING MECHANISM

DESCRIPTION	TYPE	ORDERING TYPE
Cable operating mechanism (without cable)		COM-0
Standard type handle (with operating mechanism)	NEMA Type 1, 12, 3, 3R, 4	[COM-0]+[FHU-S]
	NEMA Type 4, 4X	[COM-0]+[FHX-S]
Cable	36 inch	FH2-36
	48 inch	FH2-48
	60 inch	FH2-60
	72 inch	FH2-72

### FLANGE HANDLES WITH VARIABLE-DEPTH OPERATING MECHANISM

DESCRIPTION	TYPE	ORDERING TYPE
Variable depth operating mechanism with threaded-rod and handle		VDM-0
Standard type handle with operating mechanism	NEMA Type 1, 12, 3, 3R, 4	[VDM-0]+[FHU-S]
	NEMA Type 4, 4X	[VDM-0]+[FHX-S]

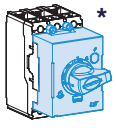
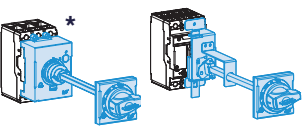
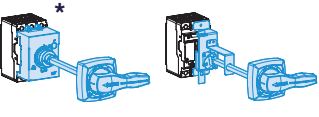
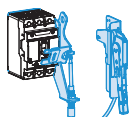
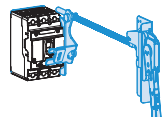
Description	Directly Mounted	Door Mounted	Flange Handle with Cable Operation Mechanism	Flange Handle with Variable Depth Mechanism
NEMA Type 1	 *	 *	-	-
NEMA Type 1, 12, 3, 3R, 4, 4X	-	 *		

\* Only 3 Pole

# SELECTION GUIDE

# UTS150



## CATALOG NUMBERING [PRODUCT SELECTION]

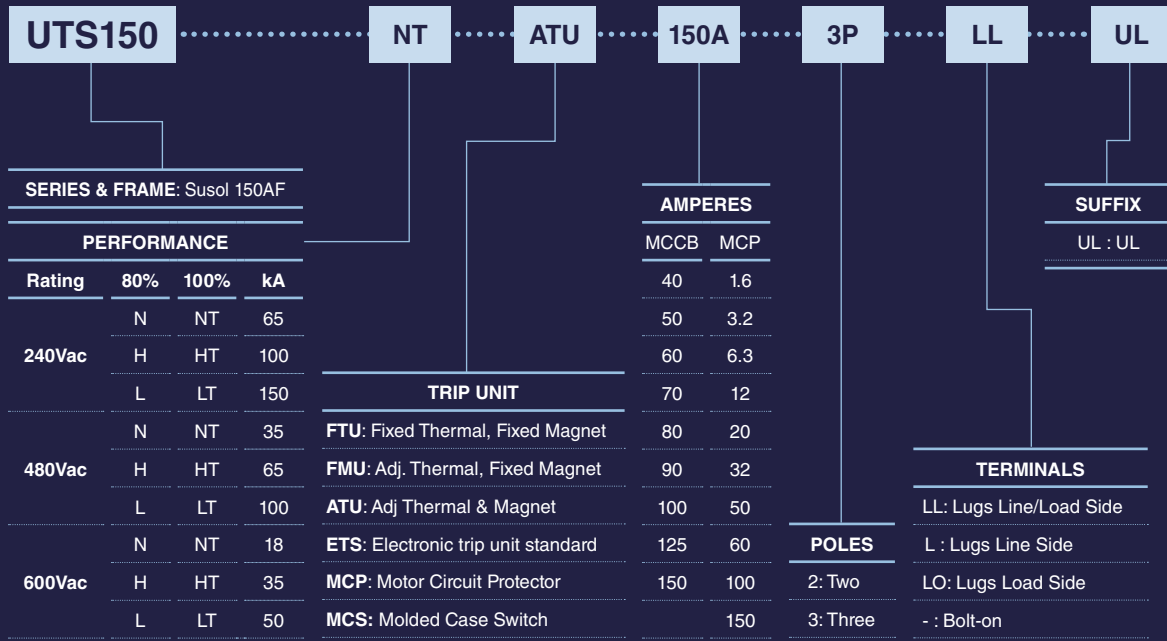



## UTS150 FRAME

- UTS150 breaker is HACR rated

### UL489 RATINGS

BREAKER TYPE	NUMBER OF POLES	INTERRUPTING CAPACITY (kA rms) AC 50/60Hz			INTERRUPTING CAPACITY (kA) DC	
		240V ac	480V ac	600V ac	250V DC-2P	600V DC-3P
UTS150N	2, 3	65	35	18	35	35
UTS150H	2, 3	100	65	35	50	50
UTS150L	2, 3	150	100	50	65	65

### IEC60947-2 RATINGS

BREAKER TYPE	NUMBER OF POLES	INTERRUPTING CAPACITY(kA rms) AC 50/60Hz, Icu		
		220/240V	380/415V	480/500V
UTS150N	2, 3	65	35	18
UTS150H	2, 3	100	65	35
UTS150L	2, 3	150	100	50
Service breaking capacity, Ics (%Icu)			100%	
Insulation Voltage, Ui			750 Vac	
Impulse Withstand Voltage, Uimp			8 kVac	
Utilization Category			A	

### DIMENSIONS

POLES	DIMENSIONS inch (mm)		
	W	H	D
2-Pole	4.13 (105)	6.50 (165)	3.44 (87.5)
3-Pole			

### TRIP UNIT TYPES

	THERMAL	MAGNETIC	REMARKS
FTU	Fixed	Fixed	
FMU	Adjustable, 0.8~1 x In	Fixed	
ATU	Adjustable, 0.8~1 x In	Adjustable, 5~10 x In	
ETS	Adjustable, 15~150A	Adjustable, 1.5~11 x In / Fixed, 11 x In(LIG only)	Electronic
MCS	N.A.	Fixed, 10xIn	Magnetic only
MCP	N.A.	Adjustable, 6~12 x In	Magnetic only

\* MCP 60A: 6.7 ~ 13.3 x In

### CIRCUIT BREAKER

WITH FTU TRIP UNIT (FIXED THERMAL, FIXED MAGNETIC)						
Ampere Rating, In	65kA at 240V, 35kA at 480V, 18kA at 600V		100kA at 240V, 65kA at 480V, 35kA at 600V		150kA at 240V, 100kA at 480V, 50kA at 600V	
	2-Pole	3-Pole	2-Pole	3-Pole	2-Pole	3-Pole
40A	UTS150-N-FTU-40-2	UTS150-N-FTU-40-3	UTS150-H-FTU-40-2	UTS150-H-FTU-40-3	UTS150-L-FTU-40-2	UTS150-L-FTU-40-3
50A	UTS150-N-FTU-50-2	UTS150-N-FTU-50-3	UTS150-H-FTU-50-2	UTS150-H-FTU-50-3	UTS150-L-FTU-50-2	UTS150-L-FTU-50-3
60A	UTS150-N-FTU-60-2	UTS150-N-FTU-60-3	UTS150-H-FTU-60-2	UTS150-H-FTU-60-3	UTS150-L-FTU-60-2	UTS150-L-FTU-60-3
70A	UTS150-N-FTU-70-2	UTS150-N-FTU-70-3	UTS150-H-FTU-70-2	UTS150-H-FTU-70-3	UTS150-L-FTU-70-2	UTS150-L-FTU-70-3
80A	UTS150-N-FTU-80-2	UTS150-N-FTU-80-3	UTS150-H-FTU-80-2	UTS150-H-FTU-80-3	UTS150-L-FTU-80-2	UTS150-L-FTU-80-3
90A	UTS150-N-FTU-90-2	UTS150-N-FTU-90-3	UTS150-H-FTU-90-2	UTS150-H-FTU-90-3	UTS150-L-FTU-90-2	UTS150-L-FTU-90-3
100A	UTS150-N-FTU-100-2	UTS150-N-FTU-100-3	UTS150-H-FTU-100-2	UTS150-H-FTU-100-3	UTS150-L-FTU-100-2	UTS150-L-FTU-100-3
125A	UTS150-N-FTU-125-2	UTS150-N-FTU-125-3	UTS150-H-FTU-125-2	UTS150-H-FTU-125-3	UTS150-L-FTU-125-2	UTS150-L-FTU-125-3
150A	UTS150-N-FTU-150-2	UTS150-N-FTU-150-3	UTS150-H-FTU-150-2	UTS150-H-FTU-150-3	UTS150-L-FTU-150-2	UTS150-L-FTU-150-3

**CIRCUIT BREAKER**

WITH FMU TRIP UNIT (ADJUSTABLE THERMAL, FIXED MAGNETIC)				
Ampere Rating, In	65kA at 240V, 35kA at 480V, 18kA at 600V		100kA at 240V, 65kA at 480V, 35kA at 600V	
	2-Pole	3-Pole	2-Pole	3-Pole
40A	UTS150-N-FMU-40-2	UTS150-N-FMU-40-3	UTS150-H-FMU-40-2	UTS150-H-FMU-40-3
60A	UTS150-N-FMU-60-2	UTS150-N-FMU-60-3	UTS150-H-FMU-60-2	UTS150-H-FMU-60-3
80A	UTS150-N-FMU-80-2	UTS150-N-FMU-80-3	UTS150-H-FMU-80-2	UTS150-H-FMU-80-3
100A	UTS150-N-FMU-100-2	UTS150-N-FMU-100-3	UTS150-H-FMU-100-2	UTS150-H-FMU-100-3
125A	UTS150-N-FMU-125-2	UTS150-N-FMU-125-3	UTS150-H-FMU-125-2	UTS150-H-FMU-125-3
150A	UTS150-N-FMU-150-2	UTS150-N-FMU-150-3	UTS150-H-FMU-150-2	UTS150-H-FMU-150-3

Ampere Rating, In	150kA at 240V, 100kA at 480V, 50kA at 600V		Thermal range
	2-Pole	3-Pole	
40A	UTS150-L-FMU-40-2	UTS150-L-FMU-40-3	32-40A
60A	UTS150-L-FMU-60-2	UTS150-L-FMU-60-3	48-60A
80A	UTS150-L-FMU-80-2	UTS150-L-FMU-80-3	64-80A
100A	UTS150-L-FMU-100-2	UTS150-L-FMU-100-3	80-100A
125A	UTS150-L-FMU-125-2	UTS150-L-FMU-125-3	100~125A
150A	UTS150-L-FMU-150-2	UTS150-L-FMU-150-3	120-150A

WITH ATU TRIP UNIT (ADJUSTABLE THERMAL, ADJUSTABLE MAGNETIC)				
Ampere Rating, In	65kA at 240V, 35kA at 480V, 18kA at 600V		100kA at 240V, 65kA at 480V, 35kA at 600V	
	2-Pole	3-Pole	2-Pole	3-Pole
100A	UTS150-N-ATU-100-2	UTS150-N-ATU-100-3	UTS150-H-ATU-100-2	UTS150-H-ATU-100-3
125A	UTS150-N-ATU-125-2	UTS150-N-ATU-125-3	UTS150-H-ATU-125-2	UTS150-H-ATU-125-3
150A	UTS150-N-ATU-150-2	UTS150-N-ATU-150-3	UTS150-H-ATU-150-2	UTS150-H-ATU-150-3

Ampere Rating, In	150kA at 240V, 100kA at 480V, 50kA at 600V		Adjustable range	
	2-Pole	3-Pole	Thermal	Magnetic
100A	UTS150-L-ATU-100-2	UTS150-L-ATU-100-3	80-100A	500-1000A
125A	UTS150-L-ATU-125-2	UTS150-L-ATU-125-3	100~125A	625~1250A
150A	UTS150-L-ATU-150-2	UTS150-L-ATU-150-3	120-150A	750-1500A

WITH ETS23 LI TRIP UNIT (ELECTRONIC)				
Ampere Rating, In	65kA at 240V, 35kA at 480V, 18kA at 600V		100kA at 240V, 65kA at 480V, 35kA at 600V	
	3-Pole		3-Pole	
60A	UTS150-N-ETS23-60-3		UTS150-H-ETS23-60-3	
100A	UTS150-N-ETS23-100-3		UTS150-H-ETS23-100-3	
150A	UTS150-N-ETS23-150-3		UTS150-H-ETS23-150-3	

Ampere Rating, In	150kA at 240V, 100kA at 480V, 50kA at 600V		Setting value		
	3-Pole		I <sub>r</sub> (A)	I <sub>i</sub> (A)	T <sub>r</sub> (s)
60A	UTS150-L-ETS23-60-3		15~60A	(1.5, 2, 3, 4, 5, 6, 8, 10, 11) x I <sub>n</sub>	0.5, 1, 2, 4, 8, 16, Accuracy ±20%
100A	UTS150-L-ETS23-100-3		40~100A		
150A	UTS150-L-ETS23-150-3		60~150A		

# UTS150 FRAME

## CIRCUIT BREAKER

WWITH ETS23 LSI TRIP UNIT (ELECTRONIC)					
Ampere Rating, In	65kA at 240V, 35kA at 480V, 18kA at 600V		100kA at 240V, 65kA at 480V, 35kA at 600V		
	3-Pole		3-Pole		
60A	UTS150-N-ETS23-60-3		UTS150-H-ETS23-60-3		
100A	UTS150-N-ETS23-100-3		UTS150-H-ETS23-100-3		
150A	UTS150-N-ETS23-150-3		UTS150-H-ETS23-150-3		

Ampere Rating, In	150kA at 240V, 100kA at 480V, 50kA at 600V		Setting value		
	3-Pole		Ir (A)	Isd (A)	Ii (A)
60A	UTS150-L-ETS23-60-3		15~60A	(1.5, 2, 3, 4, 5, 6, 7, 8, 10) x Ir	(1.5, 2, 3, 4, 5, 6, 8, 10, 11) x In
100A	UTS150-L-ETS23-100-3		40~100A	Accuracy ±15%	
150A	UTS150-L-ETS23-150-3		60~150A		

WITH ETS23 LIG TRIP UNIT (ELECTRONIC)					
Ampere Rating, In	65kA at 240V, 35kA at 480V, 18kA at 600V		100kA at 240V, 65kA at 480V, 35kA at 600V		
	3-Pole		3-Pole		
60A	UTS150-N-ETS23-60-3		UTS150-H-ETS23-60-3		
100A	UTS150-N-ETS23-100-3		UTS150-H-ETS23-100-3		
150A	UTS150-N-ETS23-150-3		UTS150-H-ETS23-150-3		

Ampere Rating, In	150kA at 240V, 100kA at 480V, 50kA at 600V		Setting value			
	3-Pole		Ir (A)	Ii (A)	Ig (A)	tg (ms)
60A	UTS150-L-ETS23-60-3		15~60A			
100A	UTS150-L-ETS23-100-3		40~100A	11 x In (Fixed)	0.2~1 x In	100, 200, 300, 400
150A	UTS150-L-ETS23-150-3		60~150A			

\* Time delay at 6 x Ir: fixe 16s, accuracy ±20%

\* Time delay: non-tripping time 70ms / maximum break time 140ms

\* Tripping time: ≤60ms

## MOLDED CASE SWITCH

WITH MCS TRIP UNIT (FIXED MAGNETIC ONLY)				
Ampere Rating, In	65kA at 240V, 35kA at 480V, 18kA at 600V		100kA at 240V, 65kA at 480V, 35kA at 600V	
	2-Pole	3-Pole	2-Pole	3-Pole
150A	UTS150-N-MCS-150-2	UTS150-N-MCS-150-3	UTS150-H-MCS-150-2	UTS150-H-MCS-150-3

Ampere Rating, In	150kA at 240V, 100kA at 480V, 50kA at 600V	
	2-Pole	3-Pole
150A	UTS150-L-MCS-150-2	UTS150-L-MCS-150-3

## MOTOR CIRCUIT PROTECTOR

WITH MCP TRIP UNIT (ADJUSTABLE MAGNETIC ONLY)				
Ampere Rating, In	3-Pole	3-Pole	3-Pole	Magnetic range
1.6A	UTS150-N-MCP-1.6-3	UTS150-H-MCP-1.6-3	UTS150-L-MCP-1.6-3	10-20A
3.2A	UTS150-N-MCP-3.2-3	UTS150-H-MCP-3.2-3	UTS150-L-MCP-3.2-3	20-40A
6.3A	UTS150-N-MCP-6.3-3	UTS150-H-MCP-6.3-3	UTS150-L-MCP-6.3-3	40-80A
12A	UTS150-N-MCP-12-3	UTS150-H-MCP-12-3	UTS150-L-MCP-12-3	70-140A
20A	UTS150-N-MCP-20-3	UTS150-H-MCP-20-3	UTS150-L-MCP-20-3	120-240A
32A	UTS150-N-MCP-32-3	UTS150-H-MCP-32-3	UTS150-L-MCP-32-3	190-380A
50A	UTS150-N-MCP-50-3	UTS150-H-MCP-50-3	UTS150-L-MCP-50-3	300-600A
60A	UTS150-N-MCP-60-3	UTS150-H-MCP-60-3	UTS150-L-MCP-60-3	400-800A
100A	UTS150-N-MCP-100-3	UTS150-H-MCP-100-3	UTS150-L-MCP-100-3	600-1200A
150A	UTS150-N-MCP-150-3	UTS150-H-MCP-150-3	UTS150-L-MCP-150-3	900-1800A

## ACCESSORIES FOR UTS150

### MECHANICAL LUGS

MAXIMUM BREAKER AMPERES	TERMINAL BODY MATERIAL	WIRE TYPE	ORDERING TYPE
150A	Aluminum	Cu/Al	AL150TS

AL150TS 1.6~150A Lug

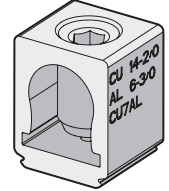

### INNER ACCESSORIES

DESCRIPTION	CONTROL VOLTAGE	ORDERING TYPE
Auxiliary Switch, AX		
Alarm Switch, AL		
Fault alarm switch, FAL		
Shunt Trip, SHT	DC 12V	
	AC/DC 24V	
	AC/DC 48V	
	AC/DC 110~130V	
	AC/DC 220~240V/DC 250V	
Undervoltage Trip, UVT	AC 380~500V	
	AC/DC 24V	
	AC/DC 48V	
	AC/DC 110~130V	
	AC 220~240V/DC 250V	
	AC 380~440V	
	AC 440~480V	

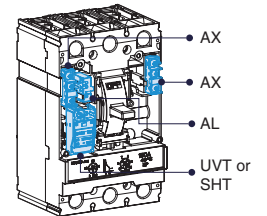

Type	Left(R)	Right(T)
AX	1	1
AL	1	-
FAL	-	1**
SHT	1*	-
UVT	1*	-

\* Applicable in indicated pole position-not synchronous

\*\* FAL can be applied to only MCCB with electronic trip release.

### PADLOCKING DEVICE

DESCRIPTION	ORDERING TYPE
Lock in "OFF" position	PL2



<Pad Lock>

### PLATE HANDLE LOCKING DEVICE

DESCRIPTION	ORDERING TYPE
Lock in "ON" "OFF" or "ON"	PHL2



<Plate Handle Lock>

### MECHANICAL INTERLOCKING DEVICE

DESCRIPTION	ORDERING TYPE
For 3-Pole breaker	MIT23



<Mechanical Interlock>

### ENCLOSURE

ENCLOSURE DIMENSION (W X H X D) Inch (mm)	ORDERING TYPE
8.58 (218) x 18.11 (460) x 4.02 (102)	-

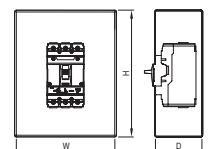



## ACCESSORIES FOR UTS150

### TERMINAL PLATES FOR BUSBAR CONNECTION

DESCRIPTION	QTY PER KIT	ORDERING TYPE
For 3-Pole breaker	3	TP2a3

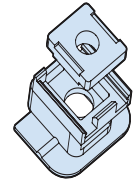

### CONTROL WIRE TERMINALS

DESCRIPTION	QTY PER KIT	ORDERING TYPE
For Mechanical Lugs and Terminal Plate	2	CWT

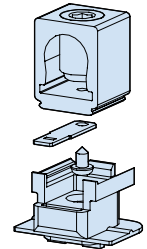

### INSULATION BARRIERS

DESCRIPTION	QTY PER KIT	ORDERING TYPE
For 3-Pole breaker	4	B23

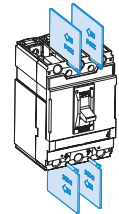

### ROTARY OPERATING HANDLES

DESCRIPTION	TYPE	ORDERING TYPE
Directly Mounted	NEMA Type 1	DH-2
Directly Mounted (with Key lock)	NEMA Type 1	DHK-2
Extended (Door-Mounted)	NEMA Type 1	REH-2
	NEMA Type 1, 12	EHU-2
NEMA Door-Mounted	NEMA Type 3, 3R, 4	EHV-2
	NEMA Type 3, 4, 4X	EHX-2

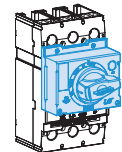

<DH-2>

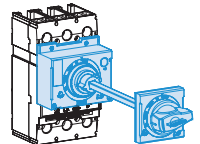

<REH-2>

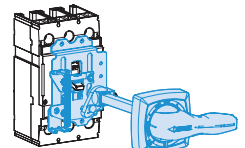

<EHU-2>

### FLANGE HANDLES WITH SLIDING OPERATING MECHANISM

DESCRIPTION	TYPE	ORDERING TYPE
Handle (with sliding mechanism and without cable)	NEMA Type 1, 12, 3, 3R, 4	FHU-2
	NEMA Type 4, 4X	FHX-2
Cable	36 inch	FH2-36
	48 inch	FH2-48
	60 inch	FH2-60
	72 inch	FH2-72

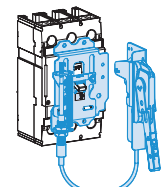

<FHU-2>

**FLANGE HANDLES WITH CABLE OPERATING MECHANISM**

DESCRIPTION	TYPE	ORDERING TYPE
Cable operating mechanism (without cable)		COM-2
Standard type handle (with operating mechanism)	NEMA Type 1, 12, 3, 3R, 4	[COM-2]+[FHU-S]
	NEMA Type 4, 4X	[COM-2]+[FHX-S]
Cable	36 inch	FH2-36
	48 inch	FH2-48
	60 inch	FH2-60
	72 inch	FH2-72

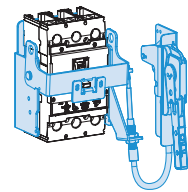

<COM-2>

**FLANGE HANDLES WITH CABLE OPERATING MECHANISM**

DESCRIPTION	TYPE	ORDERING TYPE
Variable depth operating mechanism with threaded-rod and handle		VDM-2
Standard type handle with operating mechanism	NEMA Type 1, 12, 3, 3R, 4	[VDM-2]+[FHU-S]
	NEMA Type 4, 4X	[VDM-2]+[FHX-S]

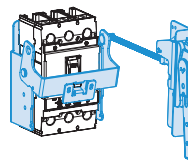

<VDM-2>

TYPE	DIRECTLY MOUNTED	DOOR MOUNTED	FLANGE HANDLE WITH CABLE OPERATION MECHANISM	FLANGE HANDLE WITH VARIABLE DEPTH MECHANISM
NEMA Type 1				
NEMA Type 1, 12, 3, 3R, 4, 4X				

**MOTOR OPERATOR**

DESCRIPTION	CONTROL VOLTAGE	ORDERING TYPE
Standard type (Not lockable)	DC 24V	MOP2U
	AC 110V/DC 110V	MOP2U
	AC 230V/DC 220V	MOP2U
Lockable type	DC 24V	MOP2U-L
	AC 110V/DC 110V	MOP2U-L
	AC 230V/DC 220V	MOP2U-L



MOP2U-L

# SELECTION GUIDE

# UTS250



## CATALOG NUMBERING [PRODUCT SELECTION]

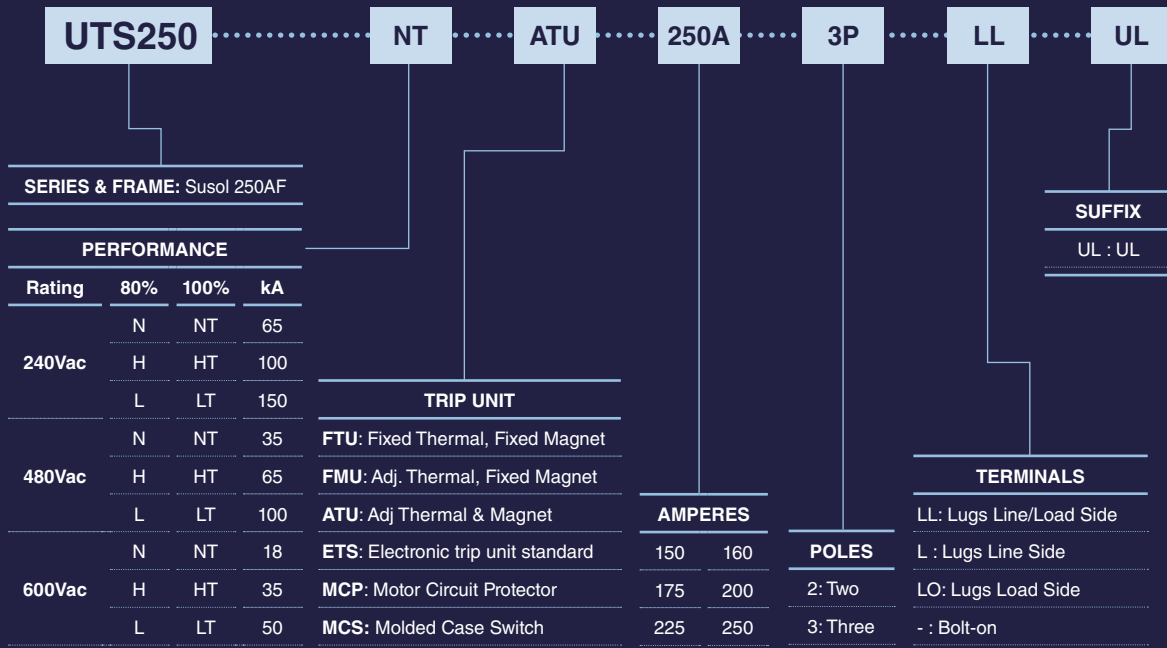

## UTS250 FRAME

UTS250 breaker is HACR rated

### UL489 RATINGS

BREAKER TYPE	NUMBER OF POLES	INTERRUPTING CAPACITY (kA rms) AC 50/60Hz			INTERRUPTING CAPACITY (kA) DC	
		240V ac	480V ac	600V ac	250V DC-2P	600V DC-3P
UTS250N	2, 3	65	35	18	35	35
UTS250H	2, 3	100	65	35	50	50
UTS250L	2, 3	150	100	50	65	65

### IEC60947-2 RATINGS

BREAKER TYPE	NUMBER OF POLES	INTERRUPTING CAPACITY(kA rms) AC 50/60Hz, Icu		
		220/240V	380/415V	480/500V
UTS250N	2, 3	65	35	18
UTS250H	2, 3	100	65	35
UTS250L	2, 3	150	100	50
Service breaking capacity, Ics (%Icu)		100%		
Insulation Voltage, Ui		750 Vac		
Impulse Withstand Voltage, Uimp		8 kVac		
Utilization Category		A		

### DIMENSIONS

POLES	DIMENSIONS inch (mm)		
	W	H	D
2-Pole	4.13 (105)	7.48 (190)	3.44 (87.5)
3-Pole			

### TRIP UNIT TYPES

	THERMAL	MAGNETIC	REMARKS
FTU	Fixed	Fixed	
FMU	Adjustable, 0.8-1 x In	Fixed	
ATU	Adjustable, 0.8-1 x In	Adjustable, 5-10 x In	
ETS	Adjustable, 60-250A	Adjustable, 1.5-11 x In / Fixed, 11 x In(LIG only)	Electronic
MCS	N.A.	Fixed, 10 x In	Magnetic only
MCP	N.A.	Adjustable, 6-12 x In	Magnetic only



# UTS250 FRAME

## CIRCUIT BREAKER

WITH FTU TRIP UNIT (FIXED THERMAL, FIXED MAGNETIC)				
Ampere Rating, In	65kA at 240V, 35kA at 480V, 18kA at 600V		100kA at 240V, 65kA at 480V, 35kA at 600V	
	2-Pole	3-Pole	2-Pole	3-Pole
150A	UTS250-N-FTU-150-2	UTS250-N-FTU-150-3	UTS250-H-FTU-150-2	UTS250-H-FTU-150-3
175A	UTS250-N-FTU-175-2	UTS250-N-FTU-175-3	UTS250-H-FTU-175-2	UTS250-H-FTU-175-3
200A	UTS250-N-FTU-200-2	UTS250-N-FTU-200-3	UTS250-H-FTU-200-2	UTS250-H-FTU-200-3
225A	UTS250-N-FTU-225-2	UTS250-N-FTU-225-3	UTS250-H-FTU-225-2	UTS250-H-FTU-225-3
250A	UTS250-N-FTU-250-2	UTS250-N-FTU-250-3	UTS250-H-FTU-250-2	UTS250-H-FTU-250-3

Ampere Rating, In	150kA at 240V, 100kA at 480V, 50kA at 600V	
	2-Pole	3-Pole
150A	UTS250-L-FTU-150-2	UTS250-L-FTU-150-3
175A	UTS250-L-FTU-175-2	UTS250-L-FTU-175-3
200A	UTS250-L-FTU-200-2	UTS250-L-FTU-200-3
225A	UTS250-L-FTU-225-2	UTS250-L-FTU-225-3
250A	UTS250-L-FTU-250-2	UTS250-L-FTU-250-3

WITH FMU TRIP UNIT (ADJUSTABLE THERMAL, FIXED MAGNETIC)				
Ampere Rating, In	65kA at 240V, 35kA at 480V, 18kA at 600V		100kA at 240V, 65kA at 480V, 35kA at 600V	
	2-Pole	3-Pole	2-Pole	3-Pole
160A	UTS250-N-FMU-160-2	UTS250-N-FMU-160-3	UTS250-H-FMU-160-2	UTS250-H-FMU-160-3
200A	UTS250-N-FMU-200-2	UTS250-N-FMU-200-3	UTS250-H-FMU-200-2	UTS250-H-FMU-200-3
250A	UTS250-N-FMU-250-2	UTS250-N-FMU-250-3	UTS250-H-FMU-250-2	UTS250-H-FMU-250-3

Ampere Rating, In	150kA at 240V, 100kA at 480V, 50kA at 600V		Thermal range
	2-Pole	3-Pole	
160A	UTS250-L-FMU-160-2	UTS250-L-FMU-160-3	128-160A
200A	UTS250-L-FMU-200-2	UTS250-L-FMU-200-3	160-200A
250A	UTS250-L-FMU-250-2	UTS250-L-FMU-250-3	200-250A

WITH ATU TRIP UNIT (ADJUSTABLE THERMAL, ADJUSTABLE MAGNETIC)				
Ampere Rating, In	65kA at 240V, 35kA at 480V, 18kA at 600V		100kA at 240V, 65kA at 480V, 35kA at 600V	
	2-Pole	3-Pole	2-Pole	3-Pole
160A	UTS250-N-ATU-160-2	UTS250-N-ATU-160-3	UTS250-H-ATU-160-2	UTS250-H-ATU-160-3
200A	UTS250-N-ATU-200-2	UTS250-N-ATU-200-3	UTS250-H-ATU-200-2	UTS250-H-ATU-200-3
250A	UTS250-N-ATU-250-2	UTS250-N-ATU-250-3	UTS250-H-ATU-250-2	UTS250-H-ATU-250-3

Ampere Rating, In	150kA at 240V, 100kA at 480V, 50kA at 600V		Adjustable range	
	2-Pole	3-Pole	Thermal	Magnetic
160A	UTS250-L-ATU-160-2	UTS250-L-ATU-160-3	128-160A	800-1600A
200A	UTS250-L-ATU-200-2	UTS250-L-ATU-200-3	160-200A	1000-2000A
250A	UTS250-L-ATU-250-2	UTS250-L-ATU-250-3	200-250A	1250-2500A

**CIRCUIT BREAKER**

WITH ETS23 LI TRIP UNIT (ELECTRONIC)					
Ampere Rating, In	65kA at 240V, 35kA at 480V, 18kA at 600V		100kA at 240V, 65kA at 480V, 35kA at 600V		
	3-Pole		3-Pole		
150A	UTS250-N-ETS23-150-3		UTS250-H-ETS23-150-3		
250A	UTS250-N-ETS23-250-3		UTS250-H-ETS23-250-3		

Ampere Rating, In	150kA at 240V, 100kA at 480V, 50kA at 600V		Setting value		
	3-Pole		I <sub>r</sub> (A)	I <sub>i</sub> (A)	T <sub>r</sub> (s)
150A	UTS250-L-ETS23-150-3		60~150A	(1.5, 2, 3, 4, 5, 6, 8, 10, 11) x I <sub>n</sub>	0.5, 1, 2, 4, 8, 16, Accuracy ±20%
250A	UTS250-L-ETS23-250-3		80~250A		

WITH ETS23 LSI TRIP UNIT FOR UTS150 (ELECTRONIC)					
Ampere Rating, In	65kA at 240V, 35kA at 480V, 18kA at 600V		100kA at 240V, 65kA at 480V, 35kA at 600V		
	3-Pole		3-Pole		
150A	UTS250-N-ETS23-150-3		UTS250-H-ETS23-150-3		
250A	UTS250-N-ETS23-250-3		UTS250-H-ETS23-250-3		

Ampere Rating, In	150kA at 240V, 100kA at 480V, 50kA at 600V		Setting value		
	3-Pole		I <sub>r</sub> (A)	I <sub>i</sub> (A)	I <sub>sd</sub> (A)
150A	UTS250-L-ETS23-150-3		60~150A	(1.5, 2, 3, 4, 5, 6, 8, 10, 11) x I <sub>n</sub>	(1.5, 2, 3, 4, 5, 6, 7, 8, 10) x I <sub>r</sub> Accuracy±15%
250A	UTS250-L-ETS23-250-3		80~250A		

WITH ETS23 LIG TRIP UNIT (ELECTRONIC)					
Ampere Rating, In	65kA at 240V, 35kA at 480V, 18kA at 600V		100kA at 240V, 65kA at 480V, 35kA at 600V		
	3-Pole		3-Pole		
150A	UTS250-N-ETS23-150-3		UTS250-H-ETS23-150-3		
250A	UTS250-N-ETS23-250-3		UTS250-H-ETS23-250-3		

Ampere Rating, In	150kA at 240V, 100kA at 480V, 50kA at 600V		Setting value			
	3-Pole		I <sub>r</sub> (A)	I <sub>i</sub> (A)	I <sub>g</sub> (A)	t <sub>g</sub> (ms)
150A	UTS250-L-ETS23-150-3		60~150A	11 x I <sub>n</sub> (Fixed)	0.2~1 x I <sub>n</sub>	100, 200, 300, 400
250A	UTS250-L-ETS23-250-3		80~250A			

\* Time delay at 6 x I<sub>r</sub>: fixe 16s, accuracy ±20%

\* Time delay: non-tripping time 70ms / maximum break time 140ms

\* Tripping time: ≤60ms

**MOLDED CASE SWITCH**

WITH MCS TRIP UNIT (FIXED MAGNETIC ONLY)				
Ampere Rating, In	65kA at 240V, 35kA at 480V, 18kA at 600V		100kA at 240V, 65kA at 480V, 35kA at 600V	
	2-Pole	3-Pole	2-Pole	3-Pole
175A	UTS250-N-MCS-175-2	UTS250-N-MCS-175-3	UTS250-H-MCS-175-2	UTS250-H-MCS-175-3
250A	UTS250-N-MCS-250-2	UTS250-N-MCS-250-3	UTS250-H-MCS-250-2	UTS250-H-MCS-250-3

Ampere Rating, In	150kA at 240V, 100kA at 480V, 50kA at 600V	
	2-Pole	3-Pole
175A	UTS250-L-MCS-175-2	UTS250-L-MCS-175-3
250A	UTS250-L-MCS-250-2	UTS250-L-MCS-250-3

**MOTOR CIRCUIT PROTECTOR**

WITH MCP TRIP UNIT (ADJUSTABLE MAGNETIC ONLY)				
Ampere Rating, In	3-Pole	3-Pole	3-Pole	Magnetic range
220A	UTS250-N-MCP-220-3	UTS250-H-MCP-220-3	UTS250-L-MCP-220-3	1320-2640A

## ACCESSORIES FOR UTS250

### MECHANICAL LUGS

MAXIMUM BREAKER AMPERES	TERMINAL BODY MATERIAL	WIRE TYPE	ORDERING TYPE
250A	Aluminum	Cu/Al	AL250TS

AL250TS 150~250A Lug

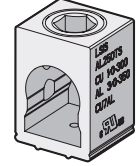

### INNER ACCESSORIES

DESCRIPTION	CONTROL VOLTAGE	ORDERING TYPE
Auxiliary Switch, AX		
Alarm Switch, AL		
Fault alarm switch, FAL		
Shunt Trip, SHT	DC 12V	
	AC/DC 24V	
	AC/DC 48V	
	AC/DC 110~130V	
	AC 220~240V/DC 250V	
Undervoltage Trip, UVT	AC 380~500V	
	AC/DC 24V	
	AC/DC 48V	
	AC/DC 110~130V	
	AC 220~240V/DC 250V	
	AC 380~440V	
	AC 440~480V	

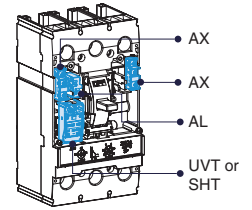

Type	Left(R)	Right(T)
AX	1	1
AL	1	-
FAL	-	1**
SHT	1*	-
UVT	1*	-

\* Applicable in indicated pole position-not synchronous  
\*\* FAL can be applied to only MCCB with electronic trip release.

### PADLOCKING DEVICE

DESCRIPTION	ORDERING TYPE
Lock in "OFF" position	PL2



<Pad Lock>

### PLATE HANDLE LOCKING DEVICE

DESCRIPTION	ORDERING TYPE
Lock in "OFF" or "ON" position	PHL2



<Plate Handle Lock>

### MECHANICAL INTERLOCKING DEVICE

DESCRIPTION	ORDERING TYPE
For 3-Pole breaker	MIT23



<Mechanical Interlock>

### ENCLOSURE

ENCLOSURE DIMENSION (W X H X D) Inch (mm)	ORDERING TYPE
12.13 (308) x 28.5 (724) x 5.35 (136)	-

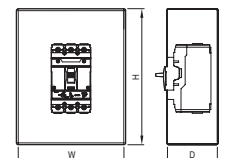

**TERMINAL PLATES FOR BUSBAR CONNECTION**

DESCRIPTION	QTY PER KIT	ORDERING TYPE
For 3-Pole breaker	3	TP2b3

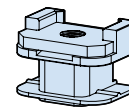

**CONTROL WIRE TERMINALS**

DESCRIPTION	QTY PER KIT	ORDERING TYPE
For Mechanical Lugs and Terminal Plate	2	CWT

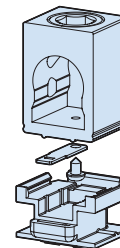

**INSULATION BARRIERS**

DESCRIPTION	QTY PER KIT	ORDERING TYPE
For 3-Pole breaker	4	B23

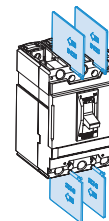

**ROTARY OPERATING HANDLES**

DESCRIPTION	TYPE	ORDERING TYPE
Directly Mounted	NEMA Type 1	DH-2
Directly Mounted (with Key lock)	NEMA Type 1	DHK-2
Extended (Door-Mounted)	NEMA Type 1	REH-2
	NEMA Type 1, 12	EHU-2
NEMA Door-Mounted	NEMA Type 3, 3R, 4	EHV-2
	NEMA Type 3, 4, 4X	EHX-2

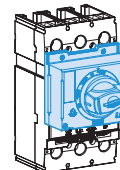

<DH-2>

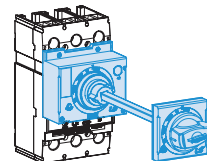

<REH-2>

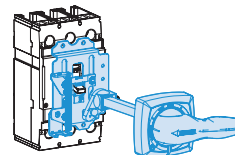

<EHU-2>

**FLANGE HANDLES WITH SLIDING OPERATING MECHANISM**

DESCRIPTION	TYPE	ORDERING TYPE
Handle (with sliding mechanism and without cable)	NEMA Type 1, 12, 3, 3R, 4	FHU-2
	NEMA Type 4, 4X	FHX-2
Cable	36 inch	FH2-36
	48 inch	FH2-48
	60 inch	FH2-60
	72 inch	FH2-72

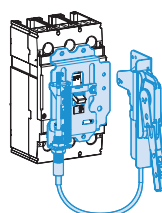

<FHU-2>



## ACCESSORIES FOR UTS250

### FLANGE HANDLES WITH CABLE OPERATING MECHANISM

DESCRIPTION	TYPE	ORDERING TYPE
Cable operating mechanism (without cable)		COM-2
Standard type handle (with operating mechanism)	NEMA Type 1, 12, 3, 3R, 4	[COM-2]+[FHU-S]
	NEMA Type 4, 4X	[COM-2]+[FHX-S]
Cable	36 inch	FH2-36
	48 inch	FH2-48
	60 inch	FH2-60
	72 inch	FH2-72

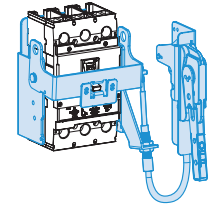

<COM-2>

### FLANGE HANDLES WITH VARIABLE-DEPTH OPERATING MECHANISM

DESCRIPTION	TYPE	ORDERING TYPE
Variable depth operating mechanism with threaded-rod and handle		VDM-2
Standard type handle with operating mechanism	NEMA Type 1, 12, 3, 3R, 4	[VDM-2]+[FHU-S]
	NEMA Type 4, 4X	[VDM-2]+[FHX-S]

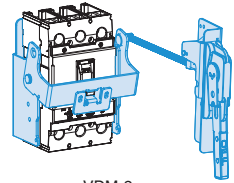

<VDM-2>

TYPE	DIRECTLY MOUNTED	DOOR MOUNTED	FLANGE HANDLE WITH CABLE OPERATION MECHANISM	FLANGE HANDLE WITH VARIABLE DEPTH MECHANISM
NEMA TYPE 1				
NEMA Type 1, 12, 3, 3R, 4, 4X				

### MOTOR OPERATOR

DESCRIPTION	CONTROL VOLTAGE	ORDERING TYPE
Standard type (Not lockable)	DC 24V	MOP2U
	AC 110V/DC 110V	MOP2U
	AC 230V/DC 220V	MOP2U
Lockable type	DC 24V	MOP2U-L
	AC 110V/DC 110V	MOP2U-L
	AC 230V/DC 220V	MOP2U-L



MOP2U-L

### RESIDUAL CURRENT DEVICE

DESCRIPTION	RATED OPERATING VOLTAGE	SENSITIVITY (A)	INTENTIONAL DELAY (MS)	ORDERING TYPE
Bolt-On type	AC240-480V	0.03-0.3-1-3-10	0-60-150-300-600	RTU23U
	AC480-600V			RTU23U
Lug type	AC240-480V	0.03-0.3-1-3-10	0-60-150-300-600	RTU23U, L
	AC480-600V			RTU23U, L



\* RTU23U can be only applied to FTU/FMU/ATU Trip Unit.

# SELECTION GUIDE

# UTS400



## CATALOG NUMBERING [PRODUCT SELECTION]

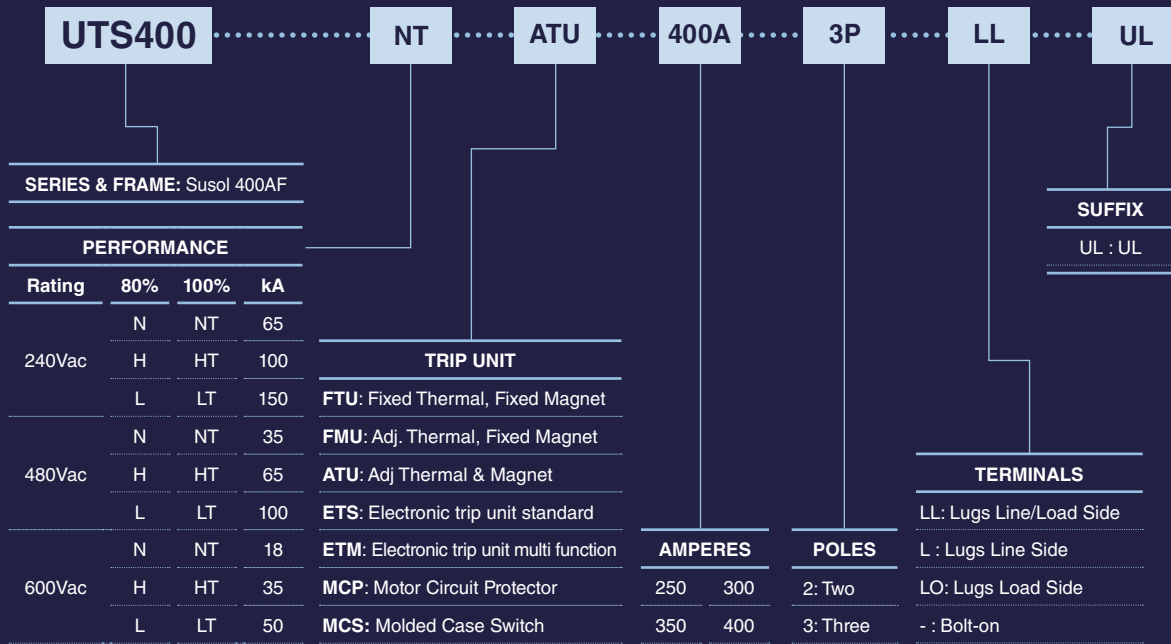

# UTS400 FRAME

UTS400 breaker is HACR rated

## UL489 RATINGS

BREAKER TYPE	NUMBER OF POLES	INTERRUPTING CAPACITY (kA rms) AC 50/60Hz			INTERRUPTING CAPACITY (kA) DC	
		240V ac	480V ac	600V ac	250V DC-2P	600V DC-3P
UTS400N	2, 3	65	35	18	35	35
UTS400H	2, 3	100	65	35	50	50
UTS400L	2, 3	150	100	50	65	65

## IEC60947-2 RATINGS

BREAKER TYPE	NUMBER OF POLES	INTERRUPTING CAPACITY(kA rms) AC 50/60Hz, Icu		
		220/240V	380/415V	480/500V
UTS400N	2, 3	65	35	18
UTS400H	2, 3	100	65	35
UTS400L	2, 3	150	100	50
Service breaking capacity, Ics (%Icu)			100%	
Insulation Voltage, Ui			750 VAC	
Impulse Withstand Voltage, Uimp			8 KVAC	
Utilization Category			A	

## DIMENSIONS

POLE	DIMENSIONS inch (mm)		
	W	H	D
2-Pole	5.51 (140)	11.42 (290)	4.33 (110)
3-Pole			

## TRIP UNIT TYPES

	THERMAL	MAGNETIC	REMARKS
FTU	Fixed	Fixed	
FMU	Adjustable, 0.8~1 x In	Fixed	
ATU	Adjustable, 0.8~1 x In	Adjustable, 5~10 x In	
ETS	Adjustable, 80~400 A	Adjustable, 1.5~11 x In	Electronic
ETM	Adjustable, 80~400 A	Adjustable, 1.5~11 x In	Electronic
MCS	N.A.	Fixed, 10 x In	Magnetic only
MCP	N.A.	Adjustable, 6~12 x In	Magnetic only

## CIRCUIT BREAKER

WITH FTU TRIP UNIT (FIXED THERMAL, FIXED MAGNETIC)				
Ampere Rating, In	65kA at 240V, 35kA at 480V, 18kA at 600V		100kA at 240V, 65kA at 480V, 35kA at 600V	
	2-Pole	3-Pole	2-Pole	3-Pole
250A	UTS400-N-FTU-250-2	UTS400-N-FTU-250-3	UTS400-H-FTU-250-2	UTS400-H-FTU-250-3
300A	UTS400-N-FTU-300-2	UTS400-N-FTU-300-3	UTS400-H-FTU-300-2	UTS400-H-FTU-300-3
350A	UTS400-N-FTU-350-2	UTS400-N-FTU-350-3	UTS400-H-FTU-350-2	UTS400-H-FTU-350-3
400A	UTS400-N-FTU-400-2	UTS400-N-FTU-400-3	UTS400-H-FTU-400-2	UTS400-H-FTU-400-3

Ampere Rating, In	150kA at 240V, 100kA at 480V, 50kA at 600V	
	2-Pole	3-Pole
250A	UTS400-L-FTU-250-2	UTS400-L-FTU-250-3
300A	UTS400-L-FTU-300-2	UTS400-L-FTU-300-3
350A	UTS400-L-FTU-350-2	UTS400-L-FTU-350-3
400A	UTS400-L-FTU-400-2	UTS400-L-FTU-400-3

**CIRCUIT BREAKER**

WITH FMU TRIP UNIT (ADJUSTABLE THERMAL, FIXED MAGNETIC)				
Ampere Rating, In	65kA at 240V, 35kA at 480V, 18kA at 600V		100kA at 240V, 65kA at 480V, 35kA at 600V	
	2-Pole	3-Pole	2-Pole	3-Pole
300A	UTS400-N-FMU-300-2	UTS400-N-FMU-300-3	UTS400-H-FMU-300-2	UTS400-H-FMU-300-3
400A	UTS400-N-FMU-400-2	UTS400-N-FMU-400-3	UTS400-H-FMU-400-2	UTS400-H-FMU-400-3

Ampere Rating, In	150kA at 240V, 100kA at 480V, 50kA at 600V		Thermal range
	2-Pole	3-Pole	
300A	UTS400-L-FMU-300-2	UTS400-L-FMU-300-3	240-300A
400A	UTS400-L-FMU-400-2	UTS400-L-FMU-400-3	320-400A

WITH ATU TRIP UNIT (ADJUSTABLE THERMAL, ADJUSTABLE MAGNETIC)				
Ampere Rating, In	65kA at 240V, 35kA at 480V, 18kA at 600V		100kA at 240V, 65kA at 480V, 35kA at 600V	
	2-Pole	3-Pole	2-Pole	3-Pole
300A	UTS400-N-ATU-300-2	UTS400-N-ATU-300-3	UTS400-H-ATU-300-2	UTS400-H-ATU-300-3
400A	UTS400-N-ATU-400-2	UTS400-N-ATU-400-3	UTS400-H-ATU-400-2	UTS400-H-ATU-400-3

Ampere Rating, In	150kA at 240V, 100kA at 480V, 50kA at 600V		Adjustable range	
	2-Pole	3-Pole	Thermal	Magnetic
300A	UTS400-L-ATU-300-2	UTS400-L-ATU-300-3	240-300A	1500-3000A
400A	UTS400-L-ATU-400-2	UTS400-L-ATU-400-3	320-400A	2000-4000A

WITH ETS33 LI TRIP UNIT (ELECTRONIC)				
Ampere Rating, In	65kA at 240V, 35kA at 480V, 18kA at 600V		100kA at 240V, 65kA at 480V, 35kA at 600V	
	3-Pole		3-Pole	
250A	UTS400-N-ETS33-250-3		UTS400-H-ETS33-250-3	
400A	UTS400-N-ETS33-450-3		UTS400-H-ETS33-450-3	

Ampere Rating, In	150kA at 240V, 100kA at 480V, 50kA at 600V		Setting value		
	3-Pole		I <sub>r</sub> (A)	I <sub>i</sub> (A)	T <sub>r</sub> (s)
250A	UTS400-L-ETS33-250-3		80-250A	(1.5, 2, 3, 4, 5, 6, 8, 10, 11) x I <sub>n</sub>	0.5, 1, 2, 4, 8, 16, Accuracy ±20%
400A	UTS400-L-ETS33-450-3		150-400A		

WITH ETS33 LSI TRIP UNIT (ELECTRONIC)				
Ampere Rating, In	65kA at 240V, 35kA at 480V, 18kA at 600V		100kA at 240V, 65kA at 480V, 35kA at 600V	
	3-Pole		3-Pole	
250A	UTS400-N-ETS33-250-3		UTS400-H-ETS33-250-3	
400A	UTS400-N-ETS33-450-3		UTS400-H-ETS33-450-3	

Ampere Rating, In	150kA at 240V, 100kA at 480V, 50kA at 600V		Setting value		
	3-Pole		I <sub>r</sub> (A)	I <sub>i</sub> (A)	I <sub>sd</sub> (A)
250A	UTS400-L-ETS33-250-3		80-250A	(1.5, 2, 3, 4, 5, 6, 8, 10, 11) x I <sub>n</sub>	(1.5, 2, 3, 4, 5, 6, 7, 8, 10) x I <sub>r</sub> Accuracy±15%
400A	UTS400-L-ETS33-450-3		150-400A		

\* Time delay at 6 x I<sub>r</sub>: fixe 16s, accuracy ±20%  
 \* Time delay: non-tripping time 20ms / maximum break time 80ms  
 \* Tripping time: ≤50ms



## UTS400 FRAME

### CIRCUIT BREAKER

WITH ETM33 TRIP UNIT (ELECTRONIC)							
Ampere Rating, In	65kA at 240V, 35kA at 480V, 18kA at 600V		100kA at 240V, 65kA at 480V, 35kA at 600V		150kA at 240V, 100kA at 480V, 50kA at 600V		
	3-Pole		3-Pole		3-Pole		
250A	UTS400-N-ETM33-250-3		UTS400-H-ETM33-250-3		UTS400-L-ETM33-250-3		
400A	UTS400-N-ETM33-450-3		UTS400-H-ETM33-450-3		UTS400-L-ETM33-450-3		

Ampere Rating, In	Setting value						
	Overload protection (long time)		Short-circuit protection (short time)		Instantaneous	Option	
	I <sub>r</sub> (A)	T <sub>r</sub> (s)	I <sub>sd</sub> (A)	t <sub>sd</sub> (ms)	I <sub>i</sub> (A)	I <sub>g</sub> (A)	t <sub>g</sub> (A)
250A	80-250A	0.5, 1, 2, 4, 8, 16, Accuracy ±20%	(1.5, 2, 3, 4, 5, 6, 7, 8, 10) x I <sub>r</sub> Accuracy ±15%	50, 100, 200, 300, 400	(1.5, 2, 3, 4, 5, 6, 8, 10, 11) x I <sub>n</sub>	0.2-1 x I <sub>n</sub>	100, 200, 300, 400
400A	150-400A						

### MOLDED CASE SWITCH

WITH MCS TRIP UNIT (FIXED MAGNETIC ONLY)				
Ampere Rating, In	65kA at 240V, 35kA at 480V, 18kA at 600V		100kA at 240V, 65kA at 480V, 35kA at 600V	
	2-Pole	3-Pole	2-Pole	3-Pole
400A	UTS400-N-MCS-400-2	UTS400-N-MCS-400-3	UTS400-H-MCS-400-2	UTS400-H-MCS-400-3

Ampere Rating, In	150kA at 240V, 100kA at 480V, 50kA at 600V	
	2-Pole	3-Pole
400A	UTS400-L-MCS-400-2	UTS400-L-MCS-400-3

### MOTOR CIRCUIT PROTECTOR

WITH MCP TRIP UNIT (ADJUSTABLE MAGNETIC ONLY)				
Ampere Rating, In	3-Pole	3-Pole	3-Pole	Magnetic Range
320A	UTS400-N-MCP-320-3	UTS400-H-MCP-320-3	UTS400-L-MCP-320-3	1920-3840A

## ACCESSORIES FOR UTS400

### MECHANICAL LUGS

MAXIMUM BREAKER AMPERES	TERMINAL BODY MATERIAL	WIRE TYPE	ORDERING TYPE
400A	Aluminum	Cu/Al	AL400TS

AL400TS 250~400A Lug

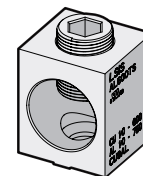

### INNER ACCESSORIES

DESCRIPTION	CONTROL VOLTAGE	ORDERING TYPE
Auxiliary Switch, AX		
Alarm Switch, AL		
Fault alarm switch, FAL		
Shunt Trip, SHT	DC 12V	
	AC/DC 24V	
	AC/DC 48V	
	AC/DC 110~130V	
	AC 220~240V/DC 250V	
Undervoltage Trip, UVT	AC 380~500V	
	AC/DC 24V	
	AC/DC 48V	
	AC/DC 110~130V	
	AC 220~240V/DC 250V	
	AC 380~440V	
	AC 440~480V	

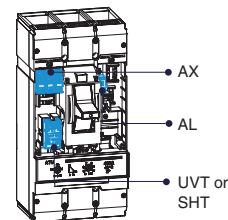

Type	Left(R)	Right(T)
AX	3	-
AL	-	1
FAL	-	1**
SHT	1*	-
UVT	1*	-

\* Applicable in indicated pole position-not synchronous

\*\* FAL can be applied to only MCCB with electronic trip release.

### PADLOCKING DEVICE

DESCRIPTION	ORDERING TYPE
Lock in "OFF" position	PL3



<Pad Lock>

### PLATE HANDLE LOCKING DEVICE

DESCRIPTION	ORDERING TYPE
Lock in "OFF" or "ON" position	PHL3



<Plate Handle Lock>

### MECHANICAL INTERLOCKING DEVICE

DESCRIPTION	ORDERING TYPE
For 3-Pole breaker	MIT33



<Mechanical Interlock>

## ACCESSORIES FOR UTS400

### ENCLOSURE

ENCLOSURE DIMENSION (W X H X D) inch (mm)	ORDERING TYPE
13.78 (350) x 40.16 (1020) x 5.98 (152) : 80% rated	-
13.78 (350) x 40.16 (1020) x 7.17 (182) : 100% rated	-

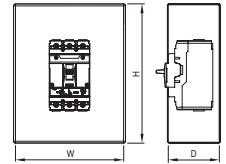

### INSULATION BARRIERS

DESCRIPTION	QTY PER KIT	ORDERING TYPE
For 3-Pole breaker	4	B33

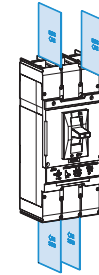

### ROTARY OPERATING HANDLES

DESCRIPTION	TYPE	ORDERING TYPE
Directly Mounted	NEMA Type 1	DH-3
Directly Mounted (with Key lock)	NEMA Type 1	DHK-3
Extended (Door-Mounted)	NEMA Type 1	REH-3
	NEMA Type 1, 12	EHU-3
NEMA Door-Mounted	NEMA Type 3, 3R, 4	EHV-3
	NEMA Type 3, 4, 4X	EHX-3

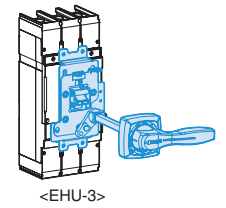
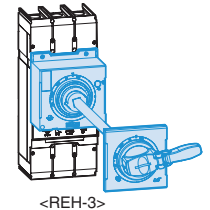
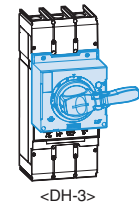

### FLANGE HANDLES WITH SLIDING OPERATING MECHANISM

DESCRIPTION	TYPE	ORDERING TYPE
Handle (with sliding mechanism and without cable)	NEMA Type 1, 12, 3, 3R, 4	FHU-3
	NEMA Type 4, 4X	FHX-3
Cable	36 inch	FH3-36
	48 inch	FH3-48
	60 inch	FH3-60
	72 inch	FH3-72

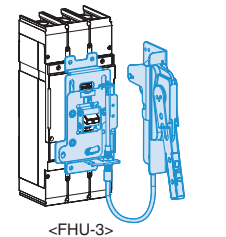

### FLANGE HANDLES WITH CABLE OPERATING MECHANISM

DESCRIPTION	TYPE	ORDERING TYPE
Cable operating mechanism (without cable)		COM-3
Long type handle (with operating mechanism)	NEMA Type 1, 12, 3, 3R, 4	[COM-3]+[FHU-L]
	NEMA Type 4, 4X	[COM-3]+[FHX-L]
Cable	36 inch	FH3-36
	48 inch	FH3-48
	60 inch	FH3-60
	72 inch	FH3-72

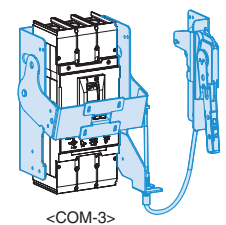

**FLANGE HANDLES WITH VARIABLE-DEPTH OPERATING MECHANISM**

DESCRIPTION	TYPE	ORDERING TYPE
Variable depth operating mechanism with threaded-rod and handle		VDM-3
Long type handle with operating mechanism	NEMA Type 1, 12, 3, 3R, 4	[VDM-3]+[FHU-L]
	NEMA Type 4, 4X	[VDM-3]+[FHX-L]

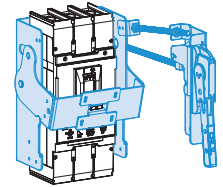

<VDM-3>

TYPE	DIRECTLY MOUNTED	DOOR MOUNTED	FLANGE HANDLE WITH CABLE OPERATION MECHANISM	FLANGE HANDLE WITH VARIABLE DEPTH MECHANISM
NEMA TYPE 1			-	-
NEMA Type 1, 12, 3, 3R, 4, 4X	-			

**MOTOR OPERATOR**

DESCRIPTION	CONTROL VOLTAGE	ORDERING TYPE
Standard type (Not lockable)	DC 24V	MOP3U
	AC 110V/DC 110V	MOP3U
	AC 230V/DC 220V	MOP3U
Lockable type	DC 24V	MOP3U-L
	AC 110V/DC 110V	MOP3U-L
	AC 230V/DC 220V	MOP3U-L



MOP3U-L



# SELECTION GUIDE

# UTS600



## CATALOG NUMBERING [PRODUCT SELECTION]

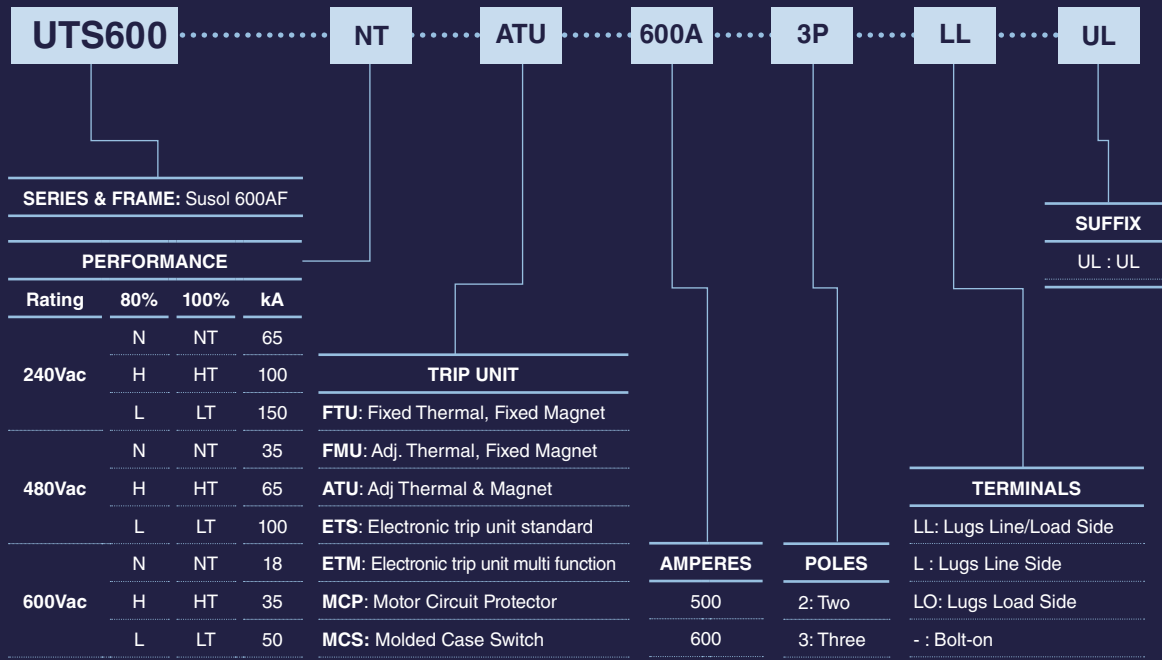

## UTS600 FRAME

UTS600 breaker is HACR rated

### UL489 RATINGS

BREAKER TYPE	NUMBER OF POLES	INTERRUPTING CAPACITY (kA rms) AC 50/60Hz			INTERRUPTING CAPACITY (kA) DC	
		240V ac	480V ac	600V ac	250V DC-2P	600V DC-3P
UTS600N	2, 3	65	35	18	35	35
UTS600H	2, 3	100	65	35	50	50
UTS600L	2, 3	150	100	50	65	65

### IEC60947-2 RATINGS

BREAKER TYPE	NUMBER OF POLES	INTERRUPTING CAPACITY(kA rms) AC 50/60Hz, Icu		
		220/240V	380/415V	480/500V
UTS600N	2, 3	65	35	18
UTS600H	2, 3	100	65	35
UTS600L	2, 3	150	100	50
Service breaking capacity, Ics (%Icu)			100%	
Insulation Voltage, Ui			750 VAC	
Impulse Withstand Voltage, Uimp			8 KVAC	
Utilization Category			A	

### DIMENSIONS

POLE	DIMENSIONS inch (mm)		
	W	H	D
2-Pole	5.51 (140)	13.39 (340)	4.33 (110)
3-Pole			

### TRIP UNIT TYPES

	THERMAL	MAGNETIC	REMARKS
FTU	Fixed	Fixed	
FMU	Adjustable, 0.8~1 x In	Fixed	
ATU	Adjustable, 0.8~1 x In	Adjustable, 5~10 x In	
ETS	Adjustable, 150~600 A	Adjustable, 1.5~11 x In	Electronic
ETM	Adjustable, 150~600 A	Adjustable, 1.5~11 x In	Electronic
MCS	N.A.	Fixed, 10 x In	Magnetic only
MCP	N.A.	Adjustable, 6~12 x In	Magnetic only

### CIRCUIT BREAKER

WITH FTU TRIP UNIT (FIXED THERMAL, FIXED MAGNETIC)				
Ampere Rating, In	65kA at 240V, 35kA at 480V, 18kA at 600V		100kA at 240V, 65kA at 480V, 35kA at 600V	
	2-Pole	3-Pole	2-Pole	3-Pole
500A	UTS600-N-FTU-500-2	UTS600-N-FTU-500-3	UTS600-H-FTU-500-2	UTS600-H-FTU-500-3
600A	UTS600-N-FTU-600-2	UTS600-N-FTU-600-3	UTS600-H-FTU-600-2	UTS600-H-FTU-600-3
Ampere Rating, In	150kA at 240V, 100kA at 480V, 50kA at 600V			
	2-Pole		3-Pole	
500A	UTS600-L-FTU-500-2		UTS600-L-FTU-500-3	
600A	UTS600-L-FTU-600-2		UTS600-L-FTU-600-3	

# UTS600 FRAME

## CIRCUIT BREAKER

WITH FMU TRIP UNIT (ADJUSTABLE THERMAL, FIXED MAGNETIC)				
Ampere Rating, In	65kA at 240V, 35kA at 480V, 18kA at 600V		100kA at 240V, 65kA at 480V, 35kA at 600V	
	2-Pole	3-Pole	2-Pole	3-Pole
500A	UTS600-N-FMU-500-2	UTS600-N-FMU-500-3	UTS600-H-FMU-500-2	UTS600-H-FMU-500-3
600A	UTS600-N-FMU-600-2	UTS600-N-FMU-600-3	UTS600-H-FMU-600-2	UTS600-H-FMU-600-3

Ampere Rating, In	150kA at 240V, 100kA at 480V, 50kA at 600V		Thermal Range
	2-Pole	3-Pole	
500A	UTS600-L-FMU-500-2	UTS600-L-FMU-500-3	400-500A
600A	UTS600-L-FMU-600-2	UTS600-L-FMU-600-3	480-600A

WITH ATU TRIP UNIT (ADJUSTABLE THERMAL, ADJUSTABLE MAGNETIC)				
Ampere Rating, In	65kA at 240V, 35kA at 480V, 18kA at 600V		100kA at 240V, 65kA at 480V, 35kA at 600V	
	2-Pole	3-Pole	2-Pole	3-Pole
500A	UTS600-N-ATU-500-2	UTS600-N-ATU-500-3	UTS600-H-ATU-500-2	UTS600-H-ATU-500-3
600A	UTS600-N-ATU-600-2	UTS600-N-ATU-600-3	UTS600-H-ATU-600-2	UTS600-H-ATU-600-3

Ampere Rating, In	150kA at 240V, 100kA at 480V, 50kA at 600V		Adjustable range	
	2-Pole	3-Pole	Thermal	Magnetic
500A	UTS600-L-ATU-500-2	UTS600-L-ATU-500-3	400-500A	2500-5000A
600A	UTS600-L-ATU-600-2	UTS600-L-ATU-600-3	480-600A	3000-6000A

WITH ETS33 LI TRIP UNIT (ELECTRONIC)				
Ampere Rating, In	65kA at 240V, 35kA at 480V, 18kA at 600V		100kA at 240V, 65kA at 480V, 35kA at 600V	
	3-Pole		3-Pole	
400A	UTS600-N-ETS33-400-3		UTS600-H-ETS33-400-3	
600A	UTS600-N-ETS33-600-3		UTS600-H-ETS33-600-3	

Ampere Rating, In	150kA at 240V, 100kA at 480V, 50kA at 600V		Setting value		
	3-Pole		I <sub>r</sub> (A)	I <sub>i</sub> (A)	T <sub>r</sub> (s)
400A	UTS600-L-ETS33-400-3		150~400A	(1.5, 2, 3, 4, 5, 6, 8, 10, 11) x I <sub>n</sub>	0.5, 1, 2, 4, 8, 16, Accuracy ±20%
600A	UTS600-L-ETS33-600-3		225~600A		

WITH ETS33 LSI TRIP UNIT (ELECTRONIC)				
Ampere Rating, In	65kA at 240V, 35kA at 480V, 18kA at 600V		100kA at 240V, 65kA at 480V, 35kA at 600V	
	3-Pole		3-Pole	
400A	UTS600-N-ETS33-400-3		UTS600-H-ETS33-400-3	
600A	UTS600-N-ETS33-600-3		UTS600-H-ETS33-600-3	

Ampere Rating, In	150kA at 240V, 100kA at 480V, 50kA at 600V		Setting value		
	3-Pole		I <sub>r</sub> (A)	I <sub>i</sub> (A)	I <sub>sd</sub> (A)
400A	UTS600-L-ETS33-400-3		150~400A	(1.5, 2, 3, 4, 5, 6, 8, 10, 11) x I <sub>n</sub>	(1.5, 2, 3, 4, 5, 6, 7, 8, 10) x I <sub>r</sub> Accuracy±15%
600A	UTS600-L-ETS33-600-3		225~600A		

\* Time delay at 6 x I<sub>r</sub>: fixe 16s, accuracy ±20%  
 \* Time delay: non-tripping time 20ms / maximum break time 80ms  
 \* Tripping time: ≤50ms

**CIRCUIT BREAKER**

WITH ETM33 TRIP UNIT (ELECTRONIC)							
Ampere Rating, In	65kA at 240V, 35kA at 480V, 18kA at 600V		100kA at 240V, 65kA at 480V, 35kA at 600V		150kA at 240V, 100kA at 480V, 50kA at 600V		
	3-Pole		3-Pole		3-Pole		
400A	UTS600-N-ETM33-400-3		UTS600-H-ETM33-400-3		UTS600-L-ETM33-400-3		
600A	UTS600-N-ETM33-600-3		UTS600-H-ETM33-600-3		UTS600-L-ETM33-600-3		

Ampere Rating, In	Setting value						
	Overload protection (long time)		Short-circuit protection (short time)		Instantaneous	Option	
	I <sub>r</sub> (A)	T <sub>r</sub> (s)	I <sub>sd</sub> (A)	t <sub>sd</sub> (ms)	I <sub>i</sub> (A)	I <sub>g</sub> (A)	t <sub>g</sub> (A)
400A	150-400A	0.5, 1, 2, 4, 8, 16, Accuracy ±20%	(1.5, 2, 3, 4, 5, 6, 7, 8, 10) x I <sub>r</sub> Accuracy ±15%	50, 100, 200, 300, 400	(1.5, 2, 3, 4, 5, 6, 8, 10, 11) x I <sub>n</sub>	0.2-1 x I <sub>n</sub>	100, 200, 300, 400
600A	225-600A						

**MOLDED CASE SWITCH**

WITH MCS TRIP UNIT (FIXED MAGNETIC ONLY)				
Ampere Rating, In	65kA at 240V, 35kA at 480V, 18kA at 600V		100kA at 240V, 65kA at 480V, 35kA at 600V	
	2-Pole	3-Pole	2-Pole	3-Pole
600A	UTS600-N-MCS-600-2	UTS600-N-MCS-600-3	UTS600-H-MCS-600-2	UTS600-H-MCS-600-3

Ampere Rating, In	150kA at 240V, 100kA at 480V, 50kA at 600V	
	2-Pole	3-Pole
600A	UTS600-L-MCS-600-2	UTS600-L-MCS-600-3

**MOTOR CIRCUIT PROTECTOR**

WITH MCP TRIP UNIT (ADJUSTABLE MAGNETIC ONLY)		
Ampere Rating, In	3-Pole	3-Pole
500A	UTS600-N-MCP-500-3	UTS600-H-MCP-500-3

Ampere Rating, In	3-Pole	Magnetic Range
500A	UTS600-L-MCP-500-3	3000-6000A

## ACCESSORIES FOR UTS600

### MECHANICAL LUGS

MAXIMUM BREAKER AMPERES	TERMINAL BODY MATERIAL	WIRE TYPE	ORDERING TYPE
600A	Aluminum	Cu/Al	AL600TS

AL600TS 500~600A Lug

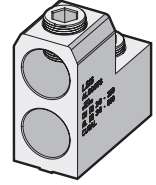

### INNER ACCESSORIES

DESCRIPTION	CONTROL VOLTAGE	ORDERING TYPE
Auxiliary Switch, AX		
Alarm Switch, AL		
Fault alarm switch, FAL		
Shunt Trip, SHT	DC 12V	
	AC/DC 24V	
	AC/DC 48V	
	AC/DC 110~130V	
	AC220~240V/DC250V	
Undervoltage Trip, UVT	AC 380~500V	
	AC/DC 24V	
	AC/DC 48V	
	AC/DC 110~130V	
	AC220~240V/DC250V	
	AC 380~440V	
	AC 440~480V	

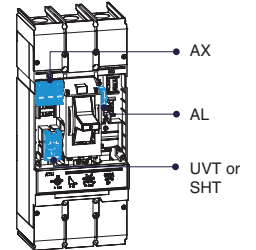

Type	Left(R)	Right(T)
AX	3	-
AL	-	1
FAL	-	1**
SHT	1*	-
UVT	1*	-

\* Applicable in indicated pole position-not synchronous

\*\* FAL can be applied to only MCCB with electronic trip release.

### PADLOCKING DEVICE

DESCRIPTION	ORDERING TYPE
Lock in "OFF" position	PL3



<Pad Lock>

### PLATE HANDLE LOCKING DEVICE

DESCRIPTION	ORDERING TYPE
Lock in "OFF" or "ON" position	PHL3



<Plate Handle Lock>

### MECHANICAL INTERLOCKING DEVICE

DESCRIPTION	ORDERING TYPE
For 3-Pole breaker	MIT33



<Mechanical Interlock>



**ENCLOSURE**

ENCLOSURE DIMENSION(W X H X D) inch(mm)	ORDERING TYPE
13.78(350) x 40.16(1020) x 5.98(152) : 80% rated	-
14.17(360) x 41.34(1050) x 7.17(182) : 100% rated	-

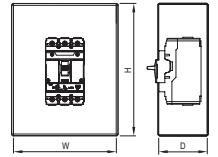

**INSULATION BARRIERS**

DESCRIPTION	QTY PER KIT	ORDERING TYPE
For 3-Pole breaker	4	B33

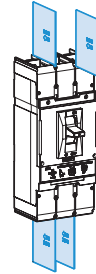

**ROTARY OPERATING HANDLES**

DESCRIPTION	TYPE	ORDERING TYPE
Directly Mounted	NEMA Type 1	DH-3
Directly Mounted (with Key lock)	NEMA Type 1	DHK-3
Extended (Door-Mounted)	NEMA Type 1	REH-3
	NEMA Type 1, 12	EHU-3
NEMA Door-Mounted	NEMA Type 3, 3R, 4	EHV-3
	NEMA Type 3, 4, 4X	EHX-3

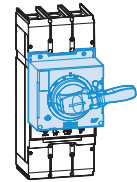

<DH-3>

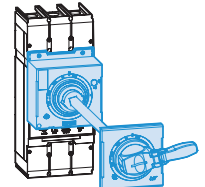

<REH-3>

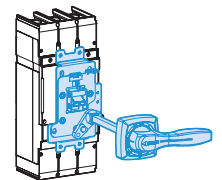

<EHU-3>

**FLANGE HANDLES WITH SLIDING OPERATING MECHANISM**

DESCRIPTION	TYPE	ORDERING TYPE
Handle(with sliding mechanism and without cable)	NEMA Type 1, 12, 3, 3R, 4	FHU-3
	NEMA Type 4, 4X	FHX-3
Cable	36 inch	FH3-36
	48 inch	FH3-48
	60 inch	FH3-60
	72 inch	FH3-72

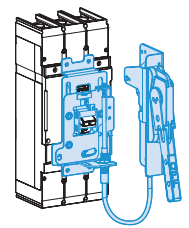

<FHU-3>

## ACCESSORIES FOR UTS600

### FLANGE HANDLES WITH CABLE OPERATING MECHANISM

DESCRIPTION	TYPE	ORDERING TYPE
Cable operating mechanism (without cable)		COM-3
Long type handle (with operating mechanism)	NEMA Type 1, 12, 3, 3R, 4	[COM-3]+[FHU-L]
	NEMA Type 4, 4X	[COM-3]+[FHX-L]
Cable	36 inch	FH3-36
	48 inch	FH3-48
	60 inch	FH3-60
	72 inch	FH3-72

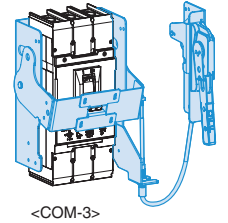

### FLANGE HANDLES WITH VARIABLE-DEPTH OPERATING MECHANISM

DESCRIPTION	TYPE	ORDERING TYPE
Variable depth operating mechanism with threaded-rod and handle		VDM-3
Long type handle with operating mechanism	NEMA Type 1, 12, 3, 3R, 4	[VDM-3]+[FHU-L]
	NEMA Type 4, 4X	[VDM-3]+[FHX-L]

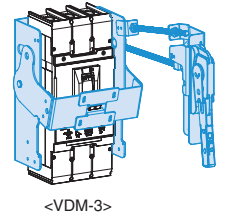

TYPE	DIRECTLY MOUNTED	DOOR MOUNTED	FLANGE HANDLE WITH CABLE OPERATION MECHANISM	FLANGE HANDLE WITH VARIABLE DEPTH MECHANISM
NEMA Type 1			-	-
NEMA Type 1, 12, 3, 3R, 4, 4X	-			

### MOTOR OPERATOR

DESCRIPTION	CONTROL VOLTAGE	ORDERING TYPE
Standard type (Not lockable)	DC 24V	MOP3U
	AC 110V/DC 110V	MOP3U
	AC 230V/DC 220V	MOP3U
Lockable type	DC 24V	MOP3U-L
	AC 110V/DC 110V	MOP3U-L
	AC 230V/DC 220V	MOP3U-L



# ELECTRONIC TRIP UNITS (STANDARD) ETS23 LI/LIG, ETS33 LI FOR UTS150/UTS250/UTS400/UTS600

## Configuration

### ETS23 LI TYPE

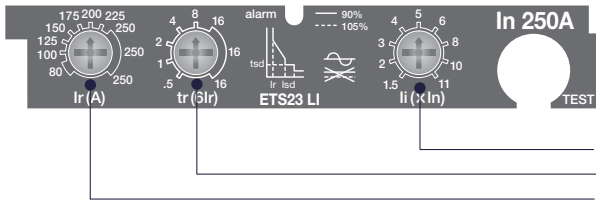

### ETS33 LI TYPE

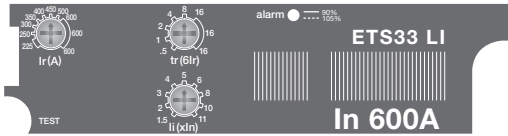

- li: Adjustable instantaneous current setting
- tr: Adjustable long time setting
- Ir: Adjustable rated current setting

### ETS23 LIG TYPE

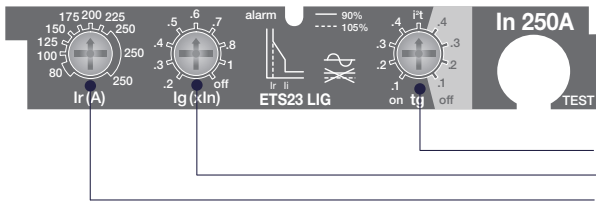

- tg: Adjustable earth fault delay setting
- lg: Adjustable earth fault current setting
- Ir: Adjustable rated current setting

※ Refer to page 51 for how to set the ground fault operation characteristics of LIG type and page 136 for the ground fault characteristic curve.

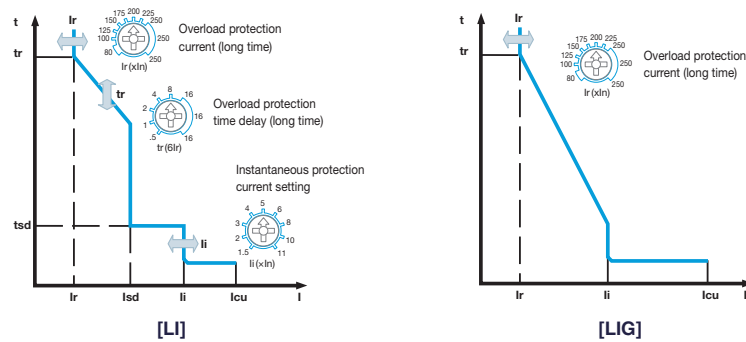

## PROTECTION (LI/LIG)

		LONG TIME									
		In (A)	Overload protection setting current(Ir=Setting value)								
Current setting (A), Ir	60A	15	20	25	30	35	40	45	50	60	
	100A	40	45	50	60	70	80	90	100	-	
	150A	60	70	80	90	100	110	125	150	-	
	250A	80	100	125	150	175	200	225	250	-	
	400A	150	175	200	225	250	300	350	400	-	
Time delay (s), tr accuracy=±20%	600A	225	250	300	350	400	450	500	600	-	
	tr@(6.0 x Ir)	0.5	1	2	4	8	16	-	-	-	
		Fixed 16s(LIG Only)									
		INSTANTANEOUS									
Current setting (A), li	li=In X ...	1.5	2	3	4	5	6	8	10	11	
		Fixed 11 x In(LIG Only)									
Tripping time		≤60ms									

# ELECTRONIC TRIP UNITS (STANDARD) ETS23 LSI, ETS33 LSI FOR UTS150/UTS250/UTS400/UTS600

## Configuration

### ETS23 LSI TYPE

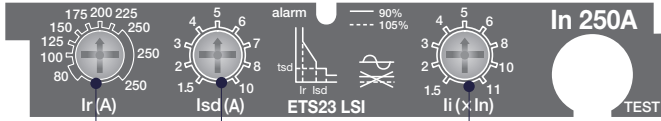

li: Adjustable instantaneous current setting  
Isd: Adjustable short time current setting  
Ir: Adjustable rated current setting

### ETS33 LSI TYPE

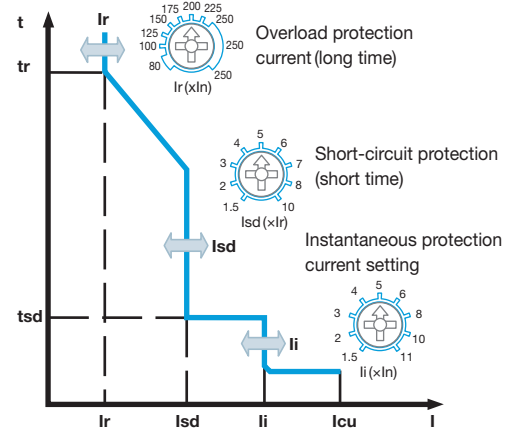
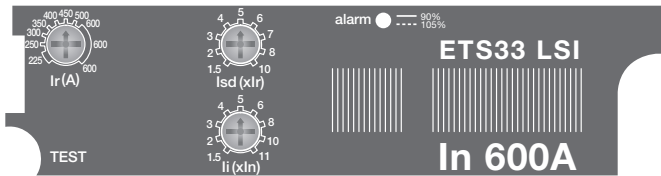

## PROTECTION (LSI)

LONG TIME										
	In (A)	Overload protection setting current(Ir=Setting value)								
				15	20	25	30	35	40	45
Current setting (A), Ir	60A	40	45	50	60	70	80	90	100	-
	100A	60	70	80	90	100	110	125	150	-
	150A	80	100	125	150	175	200	225	250	-
	250A	150	175	200	225	250	300	350	400	-
	400A	225	250	300	350	400	450	500	600	-
Time delay (s), tr	tr@6.0 x Ir	Fixed 16s								
SHORT TIME										
Current setting (A), Isd accuracy=±15%	Isd=Ir X ...	1.5	2	3	4	5	6	7	8	10
Tripping time (Non-adjustable)	Non-Tripping time	70ms								
	Maximun break time	140ms								
INSTANTANEOUS										
Current setting (A), li	li=In X ...	1.5	2	3	4	5	6	8	10	11
Tripping time		≤60ms								

# ELECTRONIC TRIP UNITS (MULTI-FUNCTION) ETM33 FOR UTS400/UTS600

## Configuration

### ETM33 TYPE

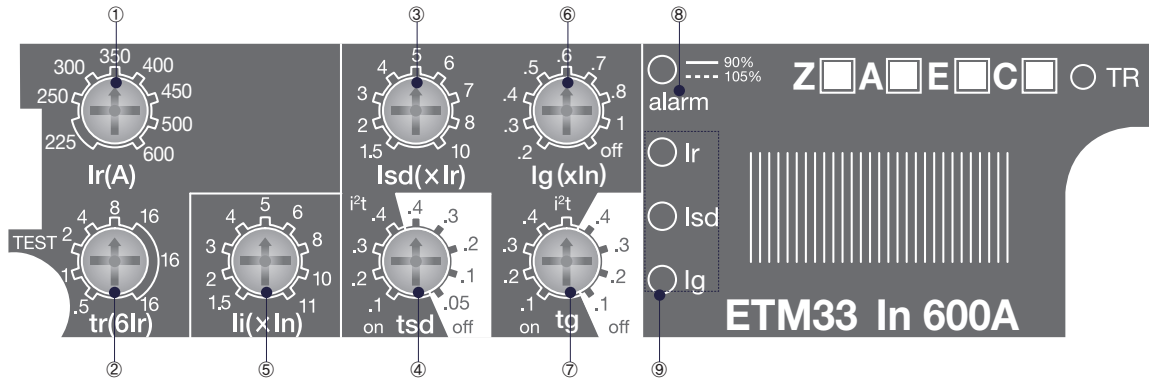

- ① Ir: Adjustable rated current setting
- ② tr: Adjustable long time setting
- ③ Isd: Adjustable short time current setting
- ④ tsd: Adjustable time delay setting
- ⑤ li: Adjustable instantaneous current setting
- ⑥ Ig: Adjustable earth fault current setting
- ⑦ tg: Adjustable earth fault delay setting
- ⑧ Alarm LED
- ⑨ Indication LED

### Alarm indication

The LED lights up and remains lit when the load exceeds 90 % of Ir.  
The LED blinks for an overload ( $\geq 105\%$  Ir), warning that the circuit breaker may trip.

### Fault indications

LEDs indicate the type of fault condition

- Ir : overload
- Isd : short-circuit ( short time, instantaneous)
- Ig : earth fault

If the TR button is pressed in the trip state, the LED indicates the trip condition.

When the breaker is reset, the LED automatically turns off and the information stored in memory disappears.

If the TR button is pressed in the normal state, all LEDs except Alarm are turned on to check the auxiliary power and LED.

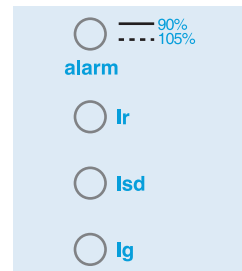

### Maintenance the Battery

1. Battery Inspection Method  
Please check if over-current LED is ON.  
Press TR button to check, replace the battery if LED does not light up .
2. When battery discharged  
Fault Indicator LED is not on and if a circuit-breaker is tripped by over-current, Thermal Memory does not operate and accordingly it holds the cold characteristic.
3. Please contact our sales team for battery purchase.  
(LS exclusive battery shall be used.)

### Change the Battery for ETM33 Series

1. Unfasten the Screw.
2. Remove the Battery.
3. Insert a New battery.
4. Insert the Battery connector into the PCB connector.
5. Fasten the screw.
6. Press the TR button.  
Confirm the alarm indication LED light.

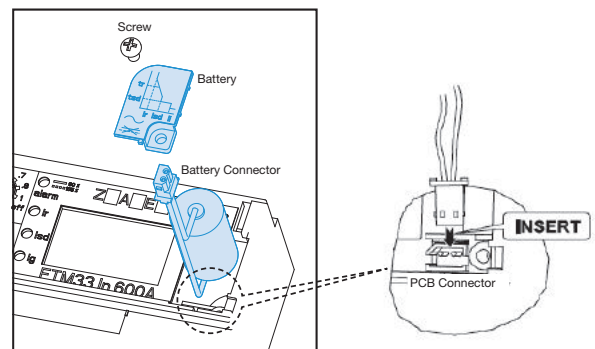



# ELECTRONIC TRIP UNITS (MULTI-FUNCTION) ETM33 FOR UTS400/UTS600

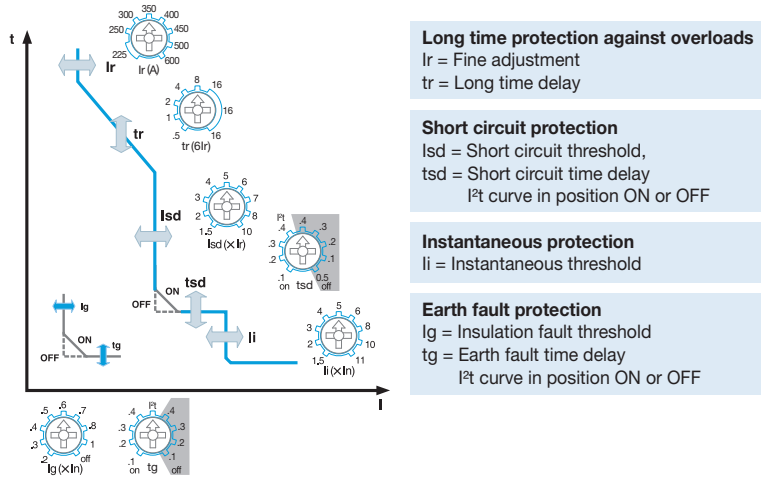

**Long time protection against overloads**  
Ir = Fine adjustment  
tr = Long time delay

**Short circuit protection**  
Isd = Short circuit threshold,  
tsd = Short circuit time delay  
I²t curve in position ON or OFF

**Instantaneous protection**  
Ii = Instantaneous threshold

**Earth fault protection**  
Ig = Insulation fault threshold  
tg = Earth fault time delay  
I²t curve in position ON or OFF

## PROTECTION

LONG TIME											
	In (A)	Overload protection setting current(Ir=Setting value)									
Current setting (A), Ir	250A	80	100	125	150	175	200	225	250	-	
	400A	150	175	200	225	250	300	350	400	-	
	600A	225	250	300	350	400	450	500	600	-	
Time delay(s),tr accuracy=±20%	tr@6.0 x Ir	0.5	1	2	4	8	16	-	-	-	
SHORT TIME											
Current setting (A), Isd accuracy=±15%	Isd=Ir X ...	1.5	2	3	4	5	6	7	8	10	
	adjustable	50	100	200	300	400					
Time delay(ms), tsd constant "I²t=fuction" On, Off	I²t On	-	Tripping time ±40ms or ±20%								
	(I²t Off) Min.trip time (ms)	30	70	140	240	350					
	(I²t Off) Max.trip time (ms)	70	140	240	350	500					
INSTANTANEOUS											
Current setting (A), Ii	Ii=In X ...	1.5	2	3	4	5	6	8	10	11	
Tripping time		≤60ms									
INDICATION OF TRIPPING REASON											
Trip reason LED indication		Ir, Isd, Ii, (Ig)									
OPTION FOR ETM											
Ammeter (A)		Maximum load phase current and R,ST phase current									
Earth fault protection (E)											
GROUND FAULT											
Pick-up (A), Ig	Ig=In X ...	0.2	0.3	0.4	0.5	0.6	0.7	0.8	0.9	1	
	adjustable	100	200	300	400						
	I²t On	Tripping time ±40ms or ±20%									
Time delay(ms), tg	(I²t Off) Min.trip time (ms)	60	140	230	350						
	(I²t Off) Max.trip time (ms)	140	230	350	500						
Communication (C)		Setting, R,S,T phase current, tripping reason									
ZSI (Z)		ZSI input and output signal									

## ELECTRONIC TRIP UNITS (MULTI-FUNCTION) ETM33 FOR UTS400/UTS600

### Short circuit protection

The short circuit threshold,  $I_{sd}$  is a multiple of the overload setting,  $I_r$ .

Setting example :

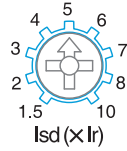
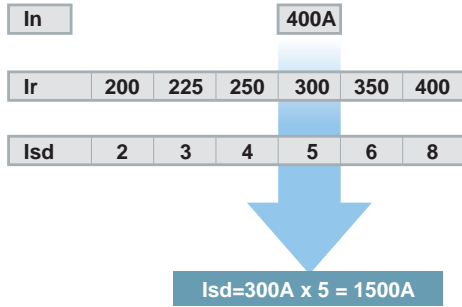

The breaker trips when the current exceeds 1500A.

### Short circuit time delay

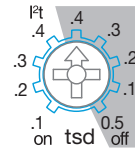
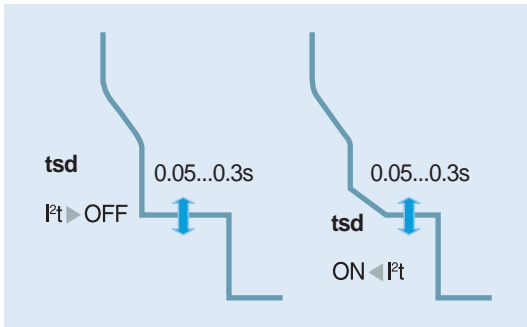

### Earth fault protection(E), optional

The ETM trip units measure the vectorial sum of the three phase current and, if present, that of the neutral conductor.

If the sum of these values exceeds the set current thresholds for a period of time greater than the time delay, the breaker is tripped.

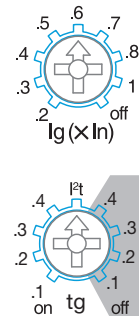
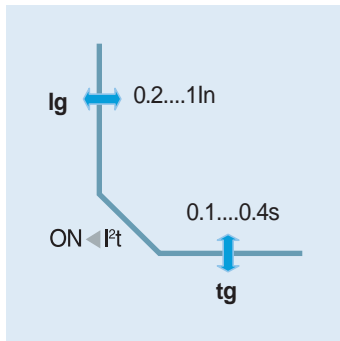
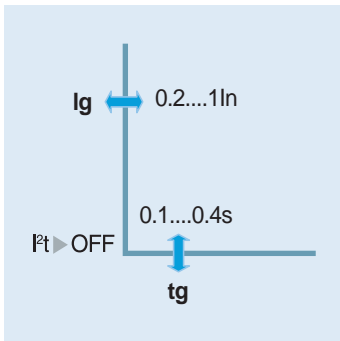

$I_g$  = insulation fault threshold  
 $t_g$  = earth fault time delay

## ELECTRONIC TRIP UNITS (MULTI-FUNCTION) ETM33 FOR UTS400/UTS600

### Ammeter (A), optional

The Ammeter device has an accuracy of  $\pm 10\%$ .  
The highest phase current is displayed in upper line.  
In under line, R, S and T phase current is scrolled autom.

#### Ammeter display limits:

- minimum current  $\geq 0.3 \times I_n$  (one phase)
- maximum current  $\leq 10 \times I_n$

### Zone selective interlocking (ZSI), optional

Zone Selective Interlocking is mainly used in systems with high rated current and short circuit current values, with safety and service continuity requirements.  
This type of discrimination can be achieved with circuit breakers equipped with specially designed electronic trip units (ETM for TS circuit breakers).

#### Zone selective interlocking (ZSI) is a system designed

- to reduce the stress on electrical distribution components during short-circuit or earth fault conditions.
- to reduce the tripping times (Lower than hundred milliseconds).
- to reduce the damage caused by the fault and of interferences to the power supply system;

**A number of circuit breakers are interconnected one after another by a pilot-wire.**

**Power source: DC24V Power is required.**

#### Operation

- With ZSI, ETM trip unit detects the fault and then send the signal to upstream circuit breaker which applies the set time delay and ignore its present short-time and or/ earth fault delay and clear the fault with no intentional delay.
- Without ZSI, ETM trip unit detects the fault and then trips the circuit breaker with intentional delay

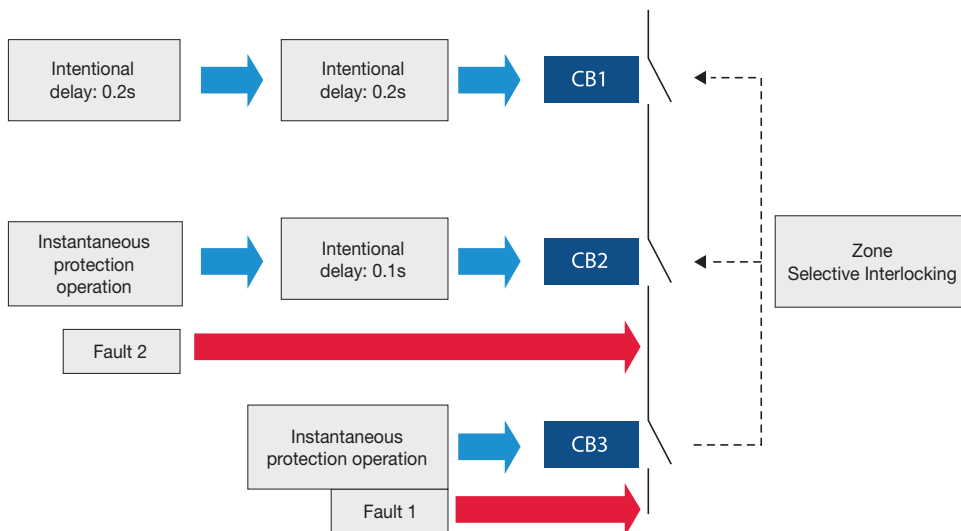

# ELECTRONIC TRIP UNITS (MULTI-FUNCTION) ETM33 FOR UTS400/UTS600

## Communication(C), optional

Communication interface: RS485 (Modbus-RTU)

The Modbus RS485 system is an open bus on which communicating Modbus devices are installed. All kinds of PLCs and computers can be connected to the bus.

### Transmitted data :

- Protection setting values
- Highest current of the three phases
- Measurement: R, S, T and N phase current
- Fault reading: Type of fault (Overload, short-circuit, etc)

The setting of communication address using TR button and LCD display (Ammeter).

Power source: DC24V Power is required.

## Combination of options

- |  |   |
|--|---|
| <input type="checkbox"/> A(Ammeter)                | <input type="checkbox"/> Z(Zone selective interlocking) |
| <input type="checkbox"/> E(Earth fault protection) | <input type="checkbox"/> Z+A                            |
| <input type="checkbox"/> A+E                       | <input type="checkbox"/> Z+E                            |
| <input type="checkbox"/> A+C(Communication)        | <input type="checkbox"/> Z+A+E                          |
| <input type="checkbox"/> A+E+C                     | <input type="checkbox"/> Z+A+C                          |
|  | <input type="checkbox"/> Z+A+E+C                        |

### FEATURE OF TRIP UNIT ACCORDING TO OPTION

ETM33 A+E

ETM33 A+E+C

ETM33 Z+A+E

ETM33 Z+A+E+C

ETM33 A

ETM33 A+C

ETM33 Z+A

ETM33 Z+A+C

ETM33 E

ETM33 E+Z

ETM33

ETM33 Z

A: Ammeter  
E: Earth fault protection  
C: Communication  
Z: Zone selective interlocking

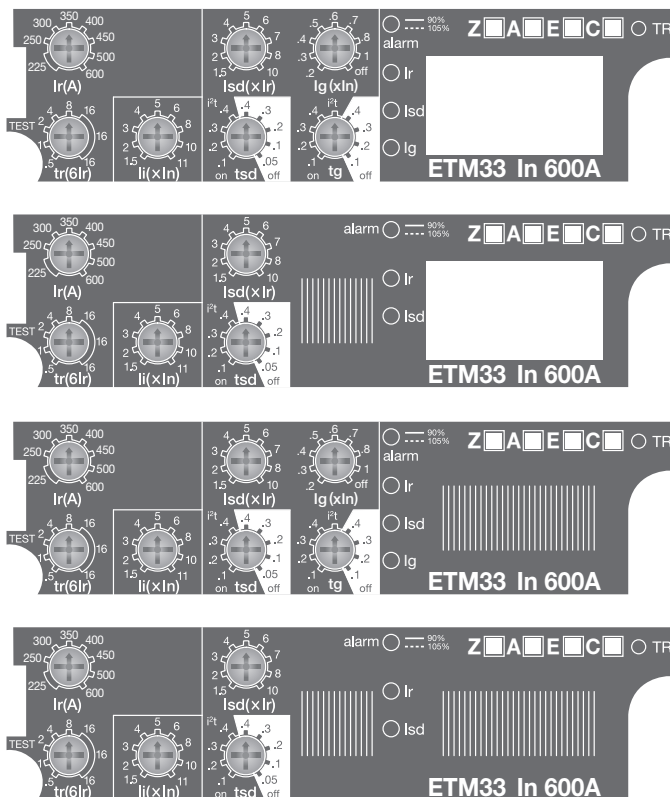

# SELECTION GUIDE

# UTS800



## CATALOG NUMBERING [PRODUCT SELECTION]

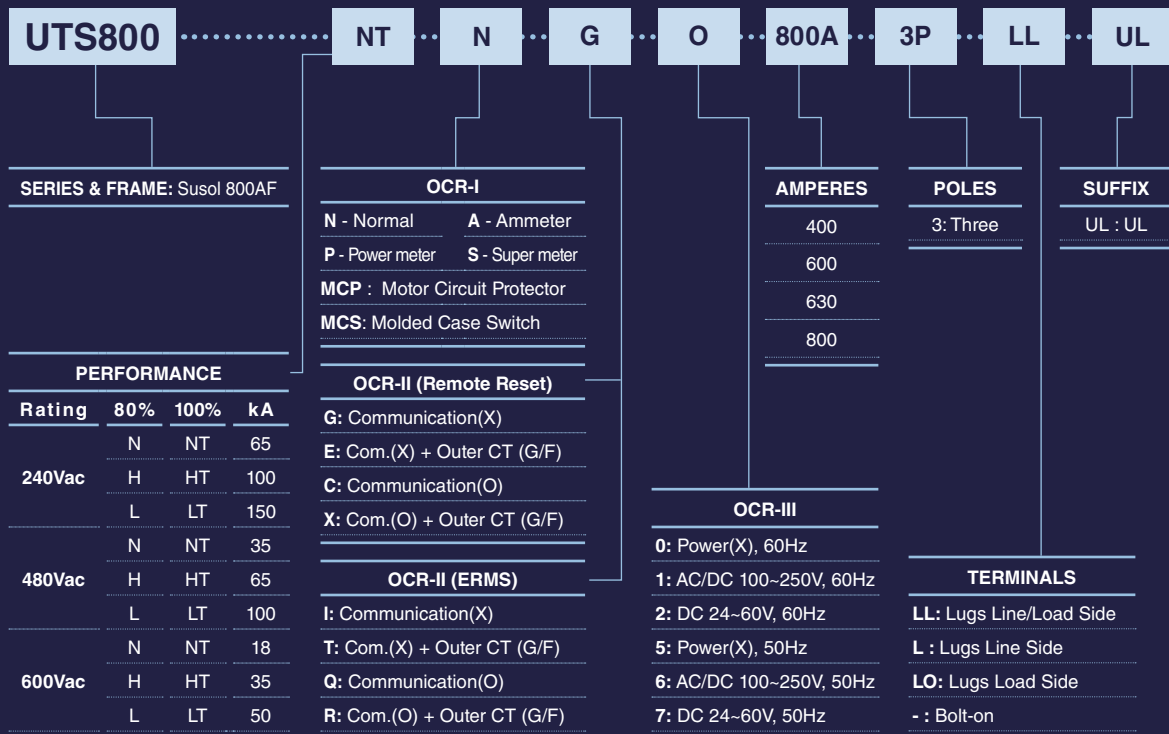

## UTS800 FRAME

UTS800 breaker is HACR rated

### UL489 RATINGS

BREAKER TYPE	NUMBER OF POLES	INTERRUPTING CAPACITY (kA rms) AC 50/60Hz		
		240V ac	480V ac	600V ac
UTS800N	3	50	35	18
UTS800H	3	100	65	35
UTS800L	3	150	100	50

### IEC60947-2 RATINGS

BREAKER TYPE	NUMBER OF POLES	INTERRUPTING CAPACITY(kA rms) AC 50/60Hz, Icu			RATED SHORT-TIME WITHSTAND CURRENT (Icw)	UTILIZATION CATEGORY
		220/240V	380/415V	480/500V		
UTS800N	3	65	35	18	18kA	B
UTS800H	3	100	65	35	-	A
UTS800L	3	150	100	50	-	A
Service breaking capacity, Ics (%Icu)				100%		
Insulation Voltage, Ui				1000 Vac		
Impulse Withstand Voltage, Uimp				8 kVac		

### DIMENSIONS

POLE	DIMENSIONS inch (mm)		
	W	H	D
3-Pole	8.27 (210)	12.88 (327.2)	6 (152.5)

### CIRCUIT BREAKER

WITH N (NORMAL) TYPE TRIP UNIT				
Ampere Rating, In	65kA at 240V, 35kA at 480V, 18kA at 600V	100kA at 240V, 65kA at 480V, 35kA at 600V	150kA at 240V, 100kA at 480V, 50kA at 600V	Remarks
	3-Pole	3-Pole	3-Pole	N(normal) type trip unit *1
400A	UTS800-N.N●●-400-3	UTS800-H.N●●-400-3	UTS800-L.N●●-400-3	Long time delay / Short time delay Instantaneous / Ground faults / Self power ※ LCD/SMPS is Removed from A type
600A	UTS800-N.N●●-600-3	UTS800-H.N●●-600-3	UTS800-L.N●●-600-3	
630A	UTS800-N.N●●-630-3	UTS800-H.N●●-630-3	UTS800-L.N●●-630-3	
800A	UTS800-N.N●●-800-3	UTS800-H.N●●-800-3	UTS800-L.N●●-800-3	

WITH A (AMMETER) TYPE TRIP UNIT				
Ampere Rating, In	65kA at 240V, 35kA at 480V, 18kA at 600V	100kA at 240V, 65kA at 480V, 35kA at 600V	150kA at 240V, 100kA at 480V, 50kA at 600V	Remarks
	3-Pole	3-Pole	3-Pole	A(ammeter) type trip unit *1
400A	UTS800-N.A●●-400-3	UTS800-H.A●●-400-3	UTS800-L.A●●-400-3	All function of N type / Earth Leakage (Except residual current) ZSI / Comm. (Modbus, Profibus) AC/DC 100-250V / DC 24-60V Fault Recording 10ea
600A	UTS800-N.A●●-600-3	UTS800-H.A●●-600-3	UTS800-L.A●●-600-3	
630A	UTS800-N.A●●-630-3	UTS800-H.A●●-630-3	UTS800-L.A●●-630-3	
800A	UTS800-N.A●●-800-3	UTS800-H.A●●-800-3	UTS800-L.A●●-800-3	

WITH P (POWER METER) TYPE TRIP UNIT				
Ampere Rating, In	65kA at 240V, 35kA at 480V, 18kA at 600V	100kA at 240V, 65kA at 480V, 35kA at 600V	150kA at 240V, 100kA at 480V, 50kA at 600V	Remarks
	3-Pole	3-Pole	3-Pole	P(power meter) type trip unit *1
400A	UTS800-N.P●●-400-3	UTS800-H.P●●-400-3	UTS800-L.P●●-400-3	All function of A type (UV/OV/OF/UF/RV/Vun/Cun) a) Measuring (V/A/W/P/F/PF) b) Fault Recording 256ea/ Event Recording 256ea
600A	UTS800-N.P●●-600-3	UTS800-H.P●●-600-3	UTS800-L.P●●-600-3	
630A	UTS800-N.P●●-630-3	UTS800-H.P●●-630-3	UTS800-L.P●●-630-3	
800A	UTS800-N.P●●-800-3	UTS800-H.P●●-800-3	UTS800-L.P●●-800-3	

Note :

a) UV: Under Voltage // OV: Over Voltage // OF: Over Frequency // UF: Under Frequency // RV: Reverse power // Vun: Voltage Unbalance // Cun: Current Unbalance

b) V: Voltage // A: Ampere // W: Watt // P: Power // F: Frequency // PF: Power factor

\* ●: OCR-II, ■: OCR-III



# UTS800 FRAME

## CIRCUIT BREAKER

WITH S (SUPER METER) TYPE TRIP UNIT				
Ampere Rating, In	65kA at 240V, 35kA at 480V, 18kA at 600V	100kA at 240V, 65kA at 480V, 35kA at 600V	150kA at 240V, 100kA at 480V, 50kA at 600V	Remarks
	3-Pole	3-Pole	3-Pole	S(super meter) type trip unit *1
400A	UTS800-N-S●■-400-3	UTS800-H-S●■-400-3	UTS800-L-S●■-400-3	All function of P type Display Harmonics and wave forms
600A	UTS800-N-S●■-600-3	UTS800-H-S●■-600-3	UTS800-L-S●■-600-3	
630A	UTS800-N-S●■-630-3	UTS800-H-S●■-630-3	UTS800-L-S●■-630-3	
800A	UTS800-N-S●■-800-3	UTS800-H-S●■-800-3	UTS800-L-S●■-800-3	

Note \*1 : The range of rated current setting is same with 4 Types but P/S type is able to set detail adjustment of rated current per 1A ( Fine Adjustable )

## MOLDED CASE SWITCH

WITH MCS TRIP UNIT (FIXED MAGNETIC ONLY)				
Ampere Rating, In	65kA at 240V, 35kA at 480V, 18kA at 600V	100kA at 240V, 65kA at 480V, 35kA at 600V	150kA at 240V, 100kA at 480V, 50kA at 600V	Remarks
	3-Pole	3-Pole	3-Pole	MCS type trip unit
800A	UTS800-N-MCS●■-800-3	UTS800-H-MCS●■-800-3	UTS800-L-MCS●■-800-3	Magnetic range : 12000A fixed

## MOTOR CIRCUIT PROTECTOR

WITH MCP TRIP UNIT (ADJUSTABLE MAGNETIC ONLY)				
Ampere Rating, In	3-Pole	3-Pole	3-Pole	Remarks
	MCP type trip unit			
800A	UTS800-N-MCP●■-800-3	UTS800-H-MCP●■-800-3	UTS800-L-MCP●■-800-3	Magnetic range : 2~12In

ITEM	SETTING RANGE
<b>Ir</b> (rated current)	0.4~1.0 In
<b>Tr</b> (long time tripping delay)	0.5~20 (s)
<b>Isd</b> (short time current)	1.5~10 Ir
<b>Tsd</b> (short time tripping delay)	0.05~0.4 (s)

ITEM	SETTING RANGE
<b>Ii</b> (instantaneous current)	2~15 In
<b>Tg</b> (ground fault tripping delay)	0.05~0.4 (s)
<b>Ig</b> (ground fault current)	0.2~1In

●	OCR-II (Remote Reset)
	<b>G:</b> Communication(X)
	<b>E:</b> Com.(X)+Outer CT(G/F)
	<b>C:</b> Communication(O)
	<b>X:</b> Com.(O)+Outer CT(G/F)

■	OCR-II (ERMS)
	<b>I:</b> Communication(X)
	<b>T:</b> Com.(X)+Outer CT(G/F)
	<b>G:</b> Communication(O)
	<b>R:</b> Com.(O)+Outer CT(G/F)

■	OCR-III
	<b>0:</b> Power(X), 60Hz
	<b>1:</b> AC/DC 100~250V, 60Hz
	<b>2:</b> DC 24~60V, 60Hz
	<b>5:</b> Power(X), 50Hz
	<b>6:</b> AC/DC 100~250V, 50Hz
	<b>7:</b> DC 24~60V, 50Hz

## ACCESSORIES FOR UTS800

### MECHANICAL LUGS

MAXIMUM BREAKER AMPERES	TERMINAL BODY MATERIAL	WIRE TYPE	ORDERING TYPE
800A	Aluminum	Cu/Al	AL800TS

AL800TS 400-800A Lug

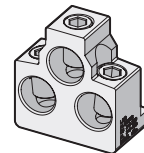

### INNER ACCESSORIES

DESCRIPTION	CONTROL VOLTAGE	ORDERING TYPE
Auxiliary Switch, AX		
Alarm Switch, AL		
Shunt Trip, SHT	DC 24-30V	
	AC 48V/DC 48-60V	
	AC/DC 100-130V	
	AC/DC 200-250V	
Undervoltage Trip, UVT	AC 380-480V	
	DC 24-30V	
	AC 48V/DC 48-60V	
	AC/DC 100-130V	
Undervoltage Trip, UVT	AC/DC 200-250V	
	AC 380-480V	

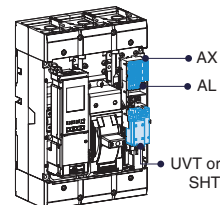

Type	Right(T)
AX	3
AL	1
SHT	1*
UVT	1*

\* Applicable in indicated pole position-not synchronous

### PADLOCKING DEVICE

DESCRIPTION	ORDERING TYPE
Lock in "OFF" position	PL5



<Pad Lock>

### PLATE HANDLE LOCKING DEVICE

DESCRIPTION	ORDERING TYPE
Lock in "OFF" or "ON" position	PHL5



<Plate Handle Lock>

### MECHANICAL INTERLOCKING DEVICE

DESCRIPTION	ORDERING TYPE
For 3-Pole breaker	MIT53



<Mechanical Interlock>

## ACCESSORIES FOR UTS800

### ENCLOSURE

ENCLOSURE DIMENSION (W X H X D) inch (mm)	ORDERING TYPE
20.25 (514.4) x 51.9 (1318.3) x 7.75 (196.9)	-

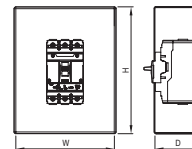

### INSULATION BARRIERS

DESCRIPTION	QTY PER KIT	ORDERING TYPE
Standard type	2	B53
Extended type	2	BE53

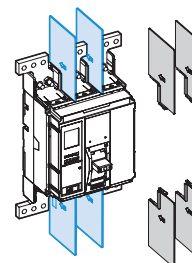

### ROTARY OPERATING HANDLES

DESCRIPTION	TYPE	ORDERING TYPE
Directly Mounted	NEMA Type 1	DH-5
Directly Mounted (with Key lock)	NEMA Type 1	DHK-5
Extended (Door-Mounted)	NEMA Type 1	REH-5
	NEMA Type 1, 12	EHU-5
NEMA Door-Mounted	NEMA Type 3, 3R, 4	EHV-5
	NEMA Type 3, 4, 4X	EHX-5

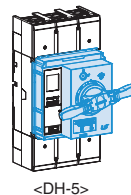

<DH-5>

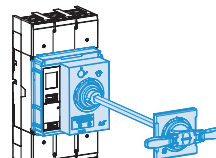

<REH-5>

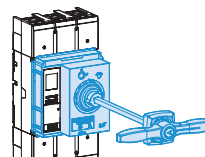

<EHU-5>

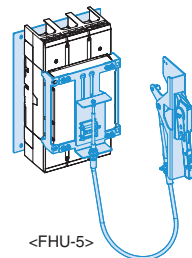

<FHU-5>

### FLANGE OPERATING HANDLES

DESCRIPTION	TYPE	ORDERING TYPE
Handles (Including driving part/ excluding cable)	NEMA Type 1, 12, 3, 3R, 4	FHU-5
	NEMA Type 4, 4X	FHX-5
Cable	60 inch	FH5-60
	84 inch	FH5-84
	128 inch	FH5-128

**FLANGE HANDLES WITH CABLE OPERATING MECHANISM**

DESCRIPTION	TYPE	ORDERING TYPE
Cable operating mechanism (without cable)		COM-5
Long type handle (with operating mechanism)	NEMA Type 1, 12, 3, 3R, 4	FHU-L
	NEMA Type 4, 4X	FHX-L
Cable	60 inch	FH5-60
	84 inch	FH5-84
	128 inch	FH5-128

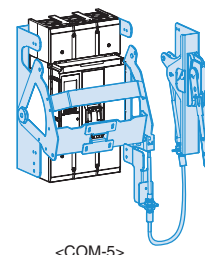

<COM-5>

**FLANGE HANDLES WITH VARIABLE-DEPTH OPERATING MECHANISM**

Description	Type	Ordering type
Variable depth operating mechanism with threaded-rod and handle		VDM-5
Long type handle (with operating mechanism)	NEMA Type 1, 12, 3, 3R, 4	FHU-L
	NEMA Type 4, 4X	FHX-L

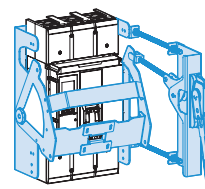

<VDM-5>

TYPE	DIRECTLY MOUNTED	DOOR MOUNTED	FLANGE HANDLE WITH CABLE/SLIDING OPERATION MECHANISM	FLANGE HANDLE WITH VARIABLE DEPTH MECHANISM
NEMA TYPE 1			-	-
NEMA Type 1, 12, 3, 3R, 4, 4X	-			

# SELECTION GUIDE

# UTS1200



## CATALOG NUMBERING [PRODUCT SELECTION]

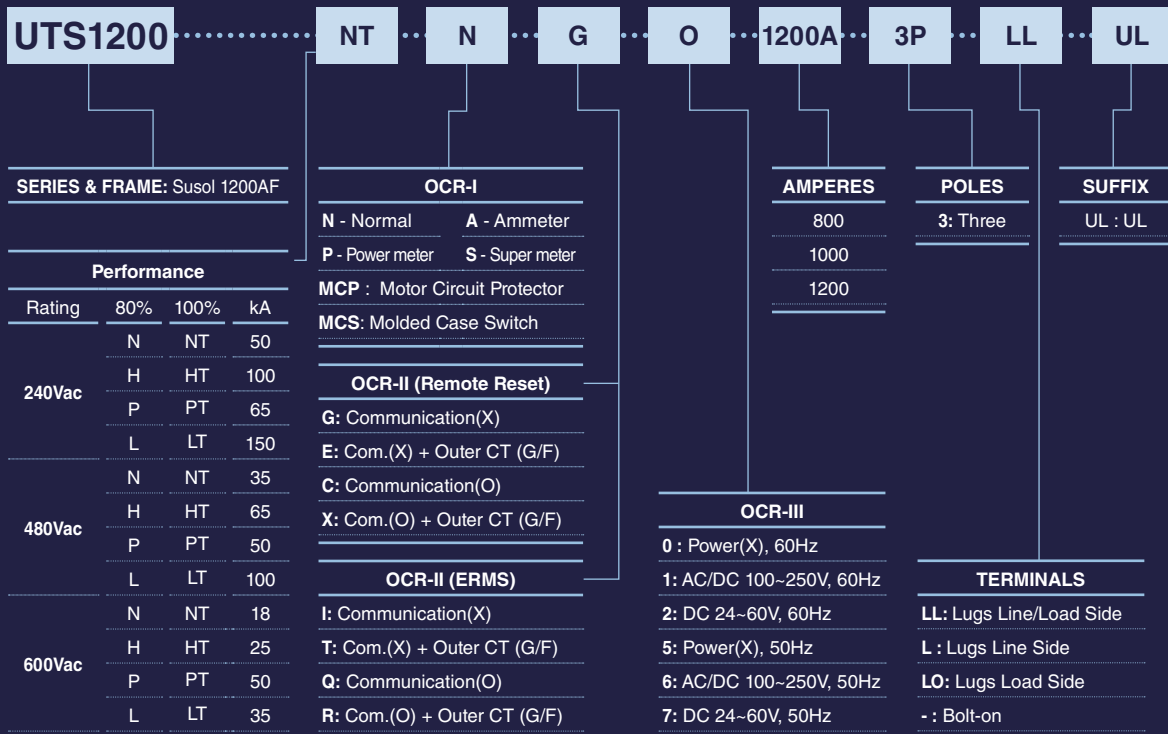

## UTS1200 FRAME

UTS1200 breaker is HACR rated

### UL489 RATINGS

BREAKER TYPE	NUMBER OF POLES	INTERRUPTING CAPACITY (kA rms) AC 50/60Hz		
		240V ac	480V ac	600V ac
UTS1200N	3	50	35	18
UTS1200H	3	100	65	25
UTS1200P	3	65	50	50
UTS1200L	3	150	100	35

### IEC60947-2 RATINGS

BREAKER TYPE	NUMBER OF POLES	INTERRUPTING CAPACITY(kA rms) AC 50/60Hz, Icu			RATED SHORT-TIME WITHSTAND CURRENT (Icw)	UTILIZATION CATEGORY
		220/240V	380/415V	480/500V		
UTS1200N	3	50	35	25	25kA	B
UTS1200H	3	100	65	35	-	A
UTS1200P	3	65	50	50	25kA	B
UTS1200L	3	150	100	50	-	A
Service breaking capacity, Ics (%Icu)				100%		
Insulation Voltage, Ui				1000 Vac		
Impulse Withstand Voltage, Uimp				8 kVac		

### DIMENSIONS

POLE	DIMENSIONS inch (mm)		
	W	H	D
3-Pole	8.27 (210)	16.26 (413)	6 (152.5)

### CIRCUIT BREAKER

WITH N (NORMAL) TYPE TRIP UNIT			
Ampere Rating, In	50kA at 240V, 35kA at 480V, 18kA at 600V	100kA at 240V, 65kA at 480V, 25kA at 600V	65kA at 240V, 50kA at 480V, 50kA at 600V
	3-Pole	3-Pole	3-Pole
800A	UTS1200-N-N●■-800-3	UTS1200-H-N●■-800-3	UTS1200-P-N●■-800-3
1000A	UTS1200-N-N●■-1000-3	UTS1200-H-N●■-1000-3	UTS1200-P-N●■-1000-3
1200A	UTS1200-N-N●■-1200-3	UTS1200-H-N●■-1200-3	UTS1200-P-N●■-1200-3

Ampere Rating, In	150kA at 240V, 100kA at 480V, 35kA at 600V	Remarks
	3-Pole	N(normal) type trip unit *1
800A	UTS1200-L-N●■-800-3	Long time delay / Short time delay Instantaneous / Ground faults / Self power *LCD/SMPS is Removed from A type
1000A	UTS1200-L-N●■-1000-3	
1200A	UTS1200-L-N●■-1200-3	

WITH A (AMMETER) TYPE TRIP UNIT			
Ampere Rating, In	50kA at 240V, 35kA at 480V, 18kA at 600V	100kA at 240V, 65kA at 480V, 25kA at 600V	65kA at 240V, 50kA at 480V, 50kA at 600V
	3-Pole	3-Pole	3-Pole
800A	UTS1200-N-A●■-800-3	UTS1200-H-A●■-800-3	UTS1200-P-A●■-800-3
1000A	UTS1200-N-A●■-1000-3	UTS1200-H-A●■-1000-3	UTS1200-P-A●■-1000-3
1200A	UTS1200-N-A●■-1200-3	UTS1200-H-A●■-1200-3	UTS1200-P-A●■-1200-3

Ampere Rating, In	150kA at 240V, 100kA at 480V, 35kA at 600V	Remarks
	3-Pole	A(ammeter) type trip unit *1
800A	UTS1200-L-A●■-800-3	All function of N type / Earth Leakage (Except residual current) ZSI / Comm. (Modbus, Profibus) AC/DC 100-250V / DC 24-60V Fault Recording 10ea
1000A	UTS1200-L-A●■-1000-3	
1200A	UTS1200-L-A●■-1200-3	

\* ●: OCR-II, ■: OCR-III



## UTS1200 FRAME

### CIRCUIT BREAKER

WITH P (POWER METER) TYPE TRIP UNIT			
Ampere Rating, In	50kA at 240V, 35kA at 480V, 18kA at 600V	100kA at 240V, 65kA at 480V, 25kA at 600V	65kA at 240V, 50kA at 480V, 50kA at 600V
	3-Pole	3-Pole	3-Pole
800A	UTS1200-N-P ● ■ -800-3	UTS1200-H-P ● ■ -800-3	UTS1200-P-P ● ■ -800-3
1000A	UTS1200-N-P ● ■ -1000-3	UTS1200-H-P ● ■ -1000-3	UTS1200-P-P ● ■ -1000-3
1200A	UTS1200-N-P ● ■ -1200-3	UTS1200-H-P ● ■ -1200-3	UTS1200-P-P ● ■ -1200-3

Ampere Rating, In	150kA at 240V, 100kA at 480V, 35kA at 600V	Remarks
	3-Pole	P(power meter) type trip unit *1
800A	UTS1200-L-P ● ■ -800-3	All function of A type (UV/OV/OF/UF/RV/Vun/Cun) <sup>a)</sup> Measuring (V/A/W/P/F/PF) <sup>b)</sup> Fault Recording 256ea / Event Recording 256ea
1000A	UTS1200-L-P ● ■ -1000-3	
1200A	UTS1200-L-P ● ■ -1200-3	

**Note :**

- a) UV: Under Voltage // OV: Over Voltage // OF: Over Frequency // UF: Under Frequency // RV: Reverse power  
// Vun: Voltage Unbalance // Cun: Current Unbalance  
b) V: Voltage // A: Ampere // W: Watt // P: Power // F: Frequency // PF: Power factor

WITH S (SUPER METER) TYPE TRIP UNIT			
Ampere Rating, In	50kA at 240V, 35kA at 480V, 18kA at 600V	100kA at 240V, 65kA at 480V, 25kA at 600V	65kA at 240V, 50kA at 480V, 50kA at 600V
	3-Pole	3-Pole	3-Pole
800A	UTS1200-N-S ● ■ -800-3	UTS1200-H-S ● ■ -800-3	UTS1200-P-S ● ■ -800-3
1000A	UTS1200-N-S ● ■ -1000-3	UTS1200-H-S ● ■ -1000-3	UTS1200-P-S ● ■ -1000-3
1200A	UTS1200-N-S ● ■ -1200-3	UTS1200-H-S ● ■ -1200-3	UTS1200-P-S ● ■ -1200-3

Ampere Rating, In	150kA at 240V, 100kA at 480V, 35kA at 600V	Remarks
	3-Pole	S(super meter) type trip unit *1
800A	UTS1200-L-S ● ■ -800-3	All function of P type Display Harmonics and wave forms
1000A	UTS1200-L-S ● ■ -1000-3	
1200A	UTS1200-L-S ● ■ -1200-3	

**Note \*1 :** The range of rated current setting is same with 4 Types but P/S type is able to set detail adjustment of rated current per 1A ( Fine Adjustable )

### MOLDED CASE SWITCH

WITH MCS TRIP UNIT (FIXED MAGNETIC ONLY)			
Ampere Rating, In	50kA at 240V, 35kA at 480V, 18kA at 600V	100kA at 240V, 65kA at 480V, 25kA at 600V	65kA at 240V, 50kA at 480V, 50kA at 600V
	3-Pole	3-Pole	3-Pole
1200A	UTS1200-N-MCS ● ■ -1200-3	UTS1200-H-MCS ● ■ -1200-3	UTS1200-P-MCS ● ■ -1200-3

Ampere Rating, In	150kA at 240V, 100kA at 480V, 35kA at 600V	Remarks
	3-Pole	MCS type trip unit
1200A	UTS1200-L-MCS ● ■ -1200-3	Magnetic range : 18000A fixed and wave forms

**MOTOR CIRCUIT PROTECTOR**

WITH MCP TRIP UNIT (ADJUSTABLE MAGNETIC ONLY)			
Ampere Rating, In	3-Pole	3-Pole	3-Pole
1200A	UTS1200-N-MCP ● ■ ·1200-3	UTS1200-H-MCP ● ■ ·1200-3	UTS1200-P-MCP ● ■ ·1200-3

Ampere Rating, In	3-Pole	Remarks
MCP type trip unit		
1200A	UTS1200-L-MCP ● ■ ·1200-3	Magnetic range : 2-8In

ITEM	SETTING RANGE
<b>I<sub>r</sub></b> (rated current)	0.4~1.0 I <sub>n</sub>
<b>T<sub>r</sub></b> (long time tripping delay)	0.5~20 (s)
<b>I<sub>sd</sub></b> (short time current)	1.5~10 I <sub>r</sub>
<b>T<sub>sd</sub></b> (short time tripping delay)	0.05~0.4 (s)

ITEM	SETTING RANGE
<b>I<sub>i</sub></b> (instantaneous current)	2~15 I <sub>n</sub>
<b>T<sub>g</sub></b> (ground fault tripping delay)	0.05~0.4 (s)
<b>I<sub>g</sub></b> (ground fault current)	0.2~1I <sub>n</sub>

●

OCR-II (Remote Reset)
<b>G:</b> Communication(X)
<b>E:</b> Com.(X)+Outer CT(G/F)
<b>C:</b> Communication(O)
<b>X:</b> Com.(O)+Outer CT(G/F)

OCR-II (ERMS)
<b>I:</b> Communication(X)
<b>T:</b> Com.(X)+Outer CT(G/F)
<b>G:</b> Communication(O)
<b>R:</b> Com.(O)+Outer CT(G/F)

■

OCR-III
<b>0:</b> Power(X), 60Hz
<b>1:</b> AC/DC 100~250V, 60Hz
<b>2:</b> DC 24~60V, 60Hz
<b>5:</b> Power(X), 50Hz
<b>6:</b> AC/DC 100~250V, 50Hz
<b>7:</b> DC 24~60V, 50Hz

**ACCESSORIES FOR UTS1200**

**MECHANICAL LUGS**

MAXIMUM BREAKER AMPERES	TERMINAL BODY MATERIAL	Wire type	Ordering type
1200A	Aluminum	Cu/Al	AL1200TS

AL 1200TS 800~1200A Lug

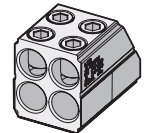

**INNER ACCESSORIES**

DESCRIPTION	CONTROL VOLTAGE	ORDERING TYPE
Auxiliary Switch, AX		
Alarm Switch, AL		
Shunt Trip, SHT	DC 24~30V	
	AC 48V/DC 48~60V	
	AC/DC 100~130V	
	AC/DC 200~250V	
Undervoltage Trip, UVT	AC 380~480V	
	DC 24~30V	
	AC 48V/DC 48~60V	
	AC/DC 100~130V	
	AC/DC 200~250V	
	AC 380~480V	

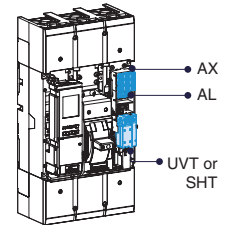

Type	Right(T)
AX	3
AL	1
SHT	1*
UVT	1*

\* Applicable in indicated pole position-not synchronous

## ACCESSORIES FOR UTS1200

### PADLOCKING DEVICE

DESCRIPTION	ORDERING TYPE
Lock in "OFF" position	PL5



<Pad Lock>

### PLATE HANDLE LOCKING DEVICE

DESCRIPTION	ORDERING TYPE
Lock in "OFF" or "ON" position	PHL5



<Plate Handle Lock>

### MECHANICAL INTERLOCKING DEVICE

DESCRIPTION	ORDERING TYPE
For 3-Pole breaker	MIT53



<Mechanical Interlock>

### ENCLOSURE

ENCLOSURE DIMENSION(W X H X D) inch (mm)	ORDERING TYPE
20.25 (514.4) x 51.9 (1318.3) x 7.75 (196.9) : 80% Rated	-
23.0 (584.2) x 62.25 (1581.2) x 14.75 (374.7) : 100% Rated	-

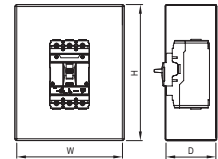

### INSULATION BARRIERS

DESCRIPTION	QTY PER KIT	ORDERING TYPE
Standard type	2	B53
Extended type	2	BE53

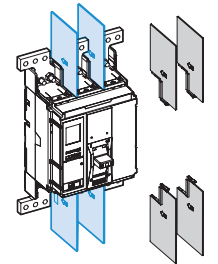

### ROTARY OPERATING HANDLES

DESCRIPTION	TYPE	ORDERING TYPE
Directly Mounted	NEMA Type 1	DH-5
Directly Mounted (with Key lock)	NEMA Type 1	DHK-5
Extended (Door-Mounted)	NEMA Type 1	REH-5
	NEMA Type 1, 12	EHU-5
NEMA Door-Mounted	NEMA Type 3, 3R, 4	EHV-5
	NEMA Type 3, 4, 4X	EHX-5

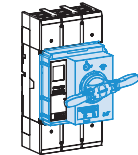

<DH-5>

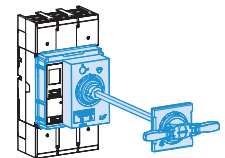

<REH-5>

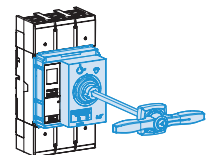

<EHU-5>

**FLANGE OPERATING HANDLES**

DESCRIPTION	TYPE	ORDERING TYPE
Handles (Including driving part/ excluding cable)	NEMA Type 1, 12, 3, 3R, 4	FHU-5
	NEMA Type 4, 4X	FHX-5
	60 inch	FH5-60
Cable	84 inch	FH5-84
	128 inch	FH5-128

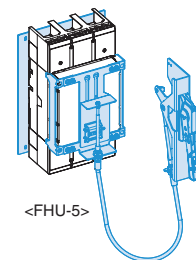

**FLANGE HANDLES WITH CABLE OPERATING MECHANISM**

DESCRIPTION	TYPE	ORDERING TYPE
Cable operating mechanism (without cable)		COM-5
Long type handle (with operating mechanism)	NEMA Type 1, 12, 3, 3R, 4	FHU-L
	NEMA Type 4, 4X	FHX-L
	60 inch	FH5-60
Cable	84 inch	FH5-84
	128 inch	FH5-128

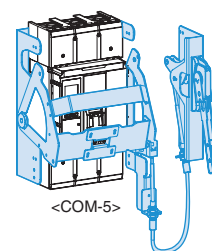

**FLANGE HANDLES WITH VARIABLE-DEPTH OPERATING MECHANISM**

DESCRIPTION	TYPE	ORDERING TYPE
Variable depth operating mechanism with threaded-rod and handle		VDM-5
Long type handle (with operating mechanism)	NEMA Type 1, 12, 3, 3R, 4	FHU-L
	NEMA Type 4, 4X	FHX-L

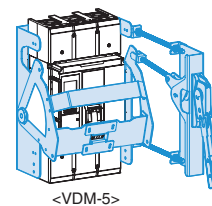

TYPE	DIRECTLY MOUNTED	DOOR MOUNTED	FLANGE HANDLE WITH CABLE/SLIDING OPERATION MECHANISM	FLANGE HANDLE WITH VARIABLE DEPTH MECHANISM
NEMA TYPE 1			-	-
NEMA Type 1, 12, 3, 3R, 4, 4X	-			

## TRIP UNITS FOR UTS800 AND UTS1200

Circuit breaker includes factory-installed internal trip units. Be careful not to interchange trip units in the field. There are various kinds of trip units according to rated current and function as follows.

### N type: Normal type

- Optimized protection function
- OCR, OCGR function according IEC60947-2
- Overload protection
  - Long-time delay
  - Thermal
- Short-circuit protection
  - Short-time delay / Instantaneous
  - I<sup>2</sup>t On/Off optional (for short-time delay)
- Ground fault protection
  - I<sup>2</sup>t On/Off optional
- Self-Power

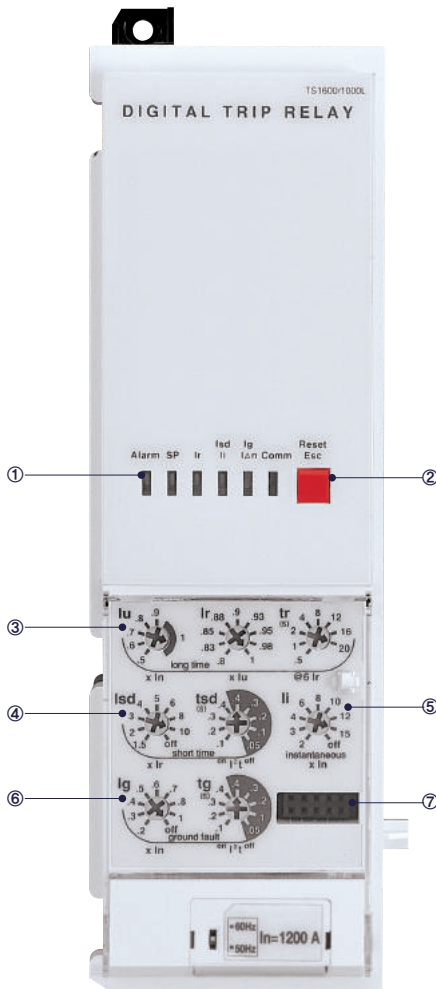

① LED: Indication of trip info, and overload state

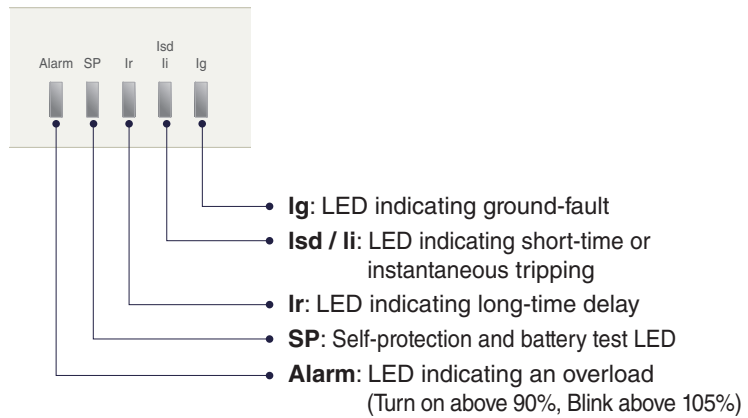

② Reset Key: Fault reset or battery check

- ③ lu, lr: Long-time current setting, tr: Long-time tripping delay setting
- ④ Isd: Short-time current setting, tsd: Short-time tripping delay setting
- ⑤ li: Instantaneous current setting
- ⑥ Ig: Ground fault setting, tg: Ground fault tripping delay setting
- ⑦ Test terminal: OCR test terminal (Connected with OCR tester)

**PROTECTION**

LONG TIME										
Current setting (A)	$I_u = I_n \times \dots$	0.5	0.6	0.7	0.8	0.9	1.0			
	$I_r = I_u \times \dots$	0.8	0.83	0.85	0.88	0.9	0.93	0.95	0.98	1.0
Time delay (s) Accuracy: $\pm 15\%$ or below 100ms	$t_r @ (1.5 \times I_r)$	12.5	25	50	100	200	300	400	500	
	$t_r @ (6.0 \times I_r)$	0.5	1	2	4	8	12	16	20	
	$t_r @ (7.2 \times I_r)$	0.34	0.69	1.38	2.7	5.5	8.3	11	13.8	
SHORT TIME										
Current setting (A) Accuracy: $\pm 10\%$	$I_{sd} = I_r \times \dots$	1.5	2	3	4	5	6	8	10	Off
	tsd	$I^2 t$ Off	0.05	0.1	0.2	0.3	0.4			
$I^2 t$ On			0.1	0.2	0.3	0.4				
Time delay (s) @ $10 \times I_r$	Min. Trip Time(ms)	20	80	160	260	360				
	$(I^2 t \text{ Off})$ Max. Trip Time(ms)	80	140	240	340	440				
INSTANTANEOUS										
Current setting (A)	$I_i = I_n \times \dots$	2	3	4	6	8	10	12	15	Off
Tripping time		50( $\pm 10$ )ms								
GROUND FAULT										
Pick-up (A) Accuracy: $\pm 10\%$ ( $I_g > 0.4 I_n$ ) $\pm 20\%$ ( $I_g < 0.4 I_n$ )	$I_g = I_n \times \dots$	0.2	0.3	0.4	0.5	0.6	0.7	0.8	1.0	Off
	tg	$I^2 t$ Off	0.05	0.1	0.2	0.3	0.4			
$I^2 t$ On			0.1	0.2	0.3	0.4				
Time delay (s) @ $1 \times I_n$	Min. Trip Time(ms)	20	80	160	260	360				
	$(I^2 t \text{ Off})$ Max. Trip Time(ms)	80	140	240	340	440				

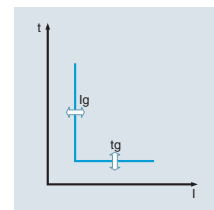
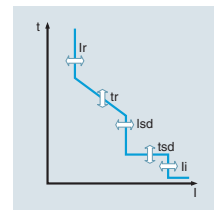



## TRIP UNITS FOR UTS800 AND UTS1200

### A type: Ammeter type

- Overload protection
  - Long-time delay
  - Thermal
- Short-circuit protection
  - Short-time delay/ Instantaneous
  - I<sup>2</sup>t On/Off optional (for short-time delay)
- Ground fault protection
  - I<sup>2</sup>t On/Off optional
- Realization of protective coordination by ZSI (Zone Selective Interlocking)
- High-performance and high-speed MCU built-in
  - Accurate measurement with tolerance of 1.0%
- Fault recording
  - Records Max. up to 10 fault information about fault type, fault phase, fault data, occurrence time of fault
- SBO (Select Before Operation)
  - High reliability for control and setting change method
- 3 DO(Digital Output)
  - Fixed
- Communication
  - Modbus/RS485
  - Profibus-DP
- ERMS
  - Arc Flash Reduction
  - Instantaneous setting value is minimized. (2\*In)

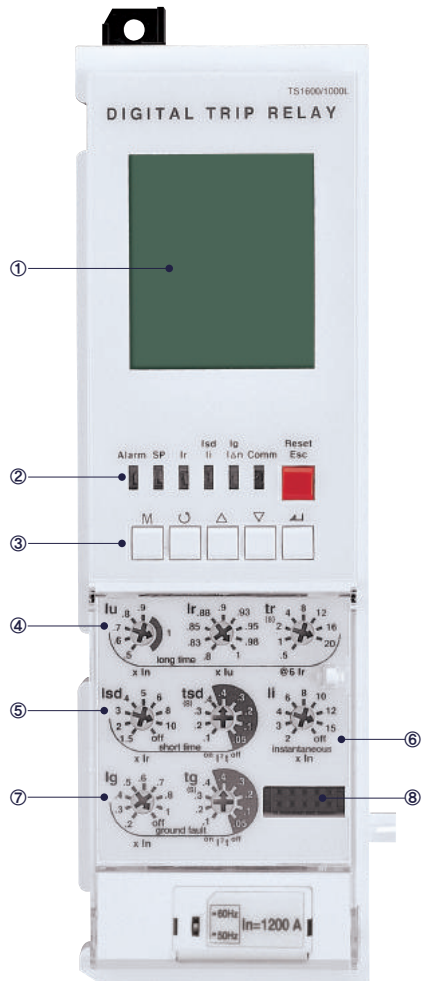

① LCD: Indication of measurement and information

② LED: Indication of trip info, and overload state

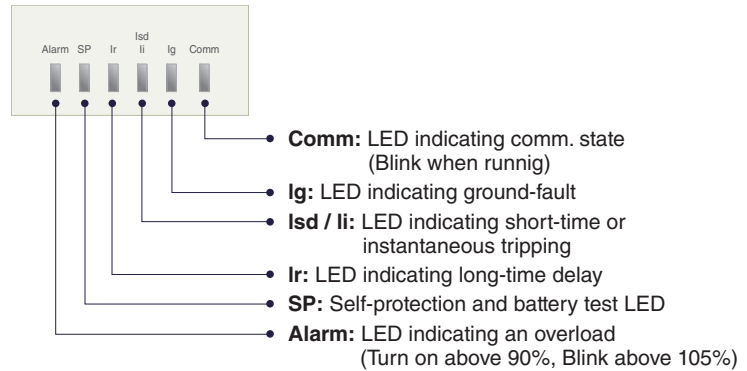

③ Key: Move to menu of reset

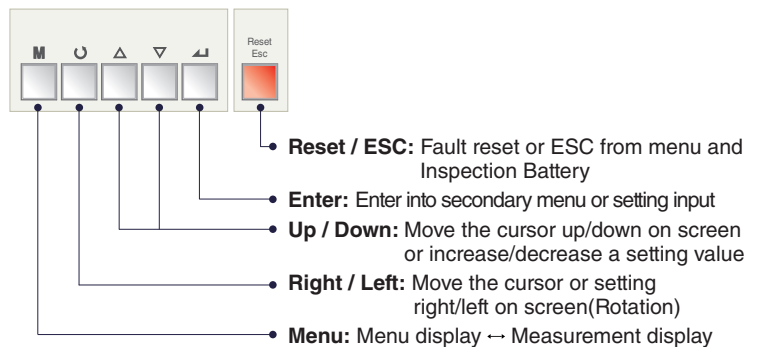

④ lu, lr: Long-time current setting, tr: Long-time tripping delay setting

⑤ lsd: Short-time current setting, tsd: Short-time tripping delay setting

⑥ li: Instantaneous current setting

⑦ Ig: Ground fault setting, tg: Ground fault tripping delay setting

⑧ Test terminal: OCR test terminal (Connected with OCR tester)

**PROTECTION**

LONG TIME											
Current setting (A)	$I_u = I_n \times \dots$	0.5	0.6	0.7	0.8	0.9	1.0				
	$I_r = I_u \times \dots$	0.8	0.83	0.85	0.88	0.9	0.93	0.95	0.98	1.0	
Time delay (s) Accuracy: $\pm 15\%$ or below 100ms	$t_r @ (1.5 \times I_r)$	12.5	25	50	100	200	300	400	500		
	$t_r @ (6.0 \times I_r)$	0.5	1	2	4	8	12	16	20		
	$t_r @ (7.2 \times I_r)$	0.34	0.69	1.38	2.7	5.5	8.3	11	13.8		
SHORT TIME											
Current setting (A) Accuracy: $\pm 10\%$	$I_{sd} = I_r \times \dots$	1.5	2	3	4	5	6	8	10	Off	
	$t_{sd}$	$I^2t$ Off	0.05	0.1	0.2	0.3	0.4				
$I^2t$ On			0.1	0.2	0.3	0.4					
Time delay (s) @ $10 \times I_r$	$(I^2t \text{ Off})$	Min. Trip Time (ms)	20	80	160	260	360				
		Max. Trip Time (ms)	80	140	240	340	440				
INSTANTANEOUS											
Current setting (A)	$I_{li} = I_n \times \dots$	2	3	4	6	8	10	12	15	Off	
Tripping time		50( $\pm 10$ )ms									
GROUND FAULT											
Pick-up (A) Accuracy: $\pm 10\%$ ( $I_g > 0.4I_n$ ) $\pm 20\%$ ( $I_g < 0.4I_n$ )	$I_g = I_n \times \dots$	0.2	0.3	0.4	0.5	0.6	0.7	0.8	1.0	Off	
	$t_g$	$I^2t$ Off	0.05	0.1	0.2	0.3	0.4				
$I^2t$ On			0.1	0.2	0.3	0.4					
Time delay (s) @ $1 \times I_n$	$(I^2t \text{ Off})$	Min. Trip Time(ms)	20	80	160	260	360				
		Max. Trip Time(ms)	80	140	240	340	440				
EARTH LEAKAGE (OPTION)											
Current setting (A)	$I_{\Delta n}$	0.5	1	2	3	5	10	20	30	Off	
Time delay (ms) Accuracy: $\pm 15\%$	$\Delta t$	Alarm Time(ms)	140	230	350	800	950				
		Trip Time(ms)	140	230	350	800					

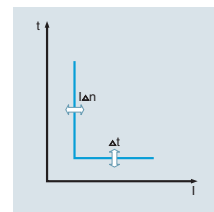
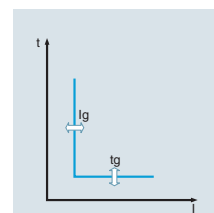
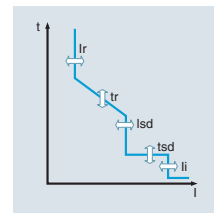

Note) Earth leakage function is available with ZCT or external CT

## TRIP UNITS FOR UTS800 AND UTS1200

### P type: Power meter type

- Overload protection
  - Long-time delay
  - Thermal
- Short-circuit protection
  - Short-time delay/Instantaneous
  - I<sup>2</sup>t On/Off optional (for short-time delay)
- Ground fault protection
  - I<sup>2</sup>t On/Off optional
- Protection for Over voltage/Under voltage/Over frequency/Under frequency/Unbalance/Reverse power
- Realization of protective coordination by ZSI (Zone Selective Interlocking)
- The fine-adjustable setting by knob and key
- IDMTL setting (SIT, VIT, EIT, EIT50, DT curve)
  - Basic setting: "None". Thermal curve.
- Measurement and Display Function
  - High detailed measurement for 3 phase Current/Voltage/Power/Energy/Phase angle/Frequency/PF/Demand
  - 128 × 128 Graphic LCD
  - Indicates current/Voltage Vector Diagram and Waveform
- Fault recording
  - Records Max. up to 256 fault information about fault type, fault phase, fault value, occurrence time of fault
- Event recording
  - Records events of device related to setting change, operation and state change. (Max. up to 256)
- SBO (Select Before Operation)
  - High reliability for control and setting change method
- 3 DO(Digital output)
  - Programmable for alarm, trip and general DO
- Communication
  - Modbus/RS485
  - Profibus-DP
- ERMS
  - Arc Flash Reduction
  - Instantaneous setting value is minimized. (2\*In)

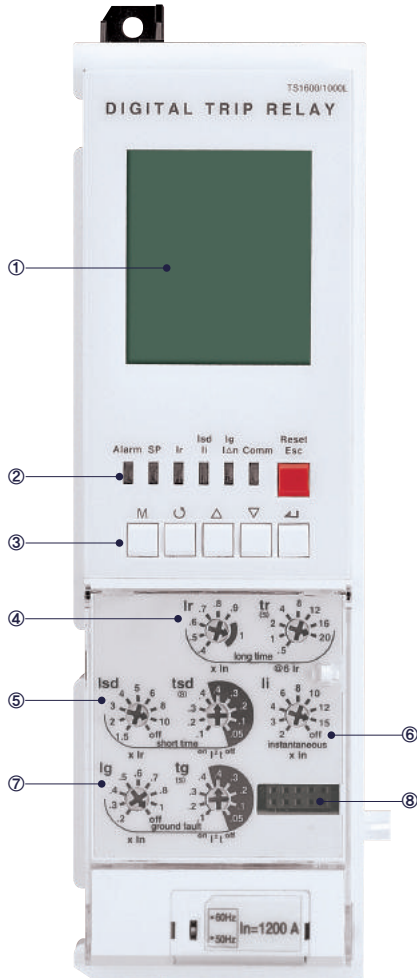

① **Graphic LCD:** Indication of measurement and information

② **LED:** Indication of trip info, and overload state

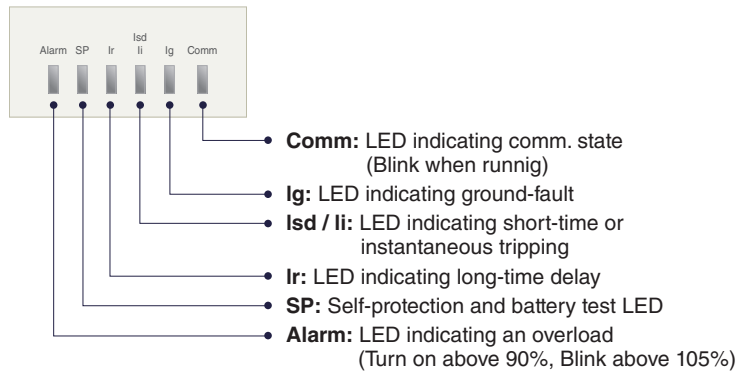

③ **Key:** Move to menu of reset

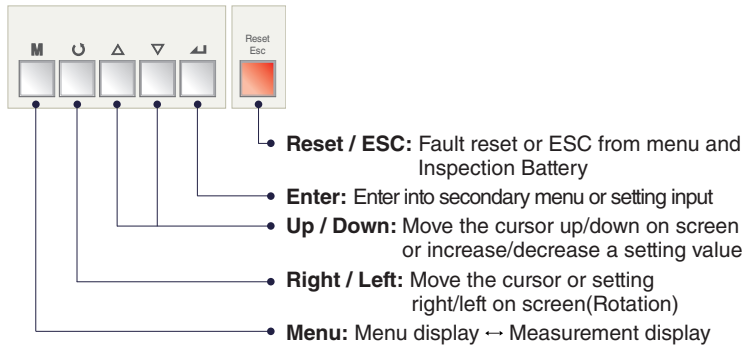

④ **I<sub>u</sub>, I<sub>r</sub>:** Long-time current setting, **tr:** Long-time tripping delay setting

⑤ **I<sub>sd</sub>:** Short-time current setting, **tsd:** Short-time tripping delay setting

⑥ **I<sub>i</sub>:** Instantaneous current setting

⑦ **I<sub>g</sub>:** Ground fault setting, **tg:** Ground fault tripping delay setting

⑧ **Test terminal:** OCR test terminal (Connected with OCR tester)

**PROTECTION**

LONG TIME										
<b>Current setting (A)</b>	$I_u = I_n \times \dots$	0.4	0.5	0.6	0.7	0.8	0.9	1.0		
<b>Time delay (s)</b>	$t_r @ (1.5 \times I_r)$	12.5	25	50	100	200	300	400	500	
<b>Accuracy: ±15% or below 100ms</b>	$t_r @ (6.0 \times I_r)$	0.5	1	2	4	8	12	16	20	
	$t_r @ (7.2 \times I_r)$	0.34	0.69	1.38	2.7	5.5	8.3	11	13.8	

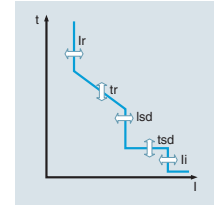

SHORT TIME										
<b>Current setting (A)</b>	$I_{sd} = I_r \times \dots$	1.5	2	3	4	5	6	8	10	Off
<b>Time delay (s) @ 10 x Ir</b>	$t_{sd}$	$I^2t$ Off	0.05	0.1	0.2	0.3	0.4			
		$I^2t$ On		0.1	0.2	0.3	0.4			
	$(I^2t \text{ Off})$	Min. Trip Time(ms)	20	80	160	260	360			
		Max. Trip Time(ms)	80	140	240	340	440			

INSTANTANEOUS										
<b>Current setting (A)</b>	$I_i = I_n \times \dots$	2	3	4	6	8	10	12	15	Off
<b>Tripping time</b>		50(±10)ms								

GROUND FAULT										
<b>Pick-up (A)</b>	$I_g = I_n \times \dots$	0.2	0.3	0.4	0.5	0.6	0.7	0.8	1.0	Off
<b>Time delay (s) @ 1 x In</b>	$t_g$	$I^2t$ Off	0.05	0.1	0.2	0.3	0.4			
		$I^2t$ On		0.1	0.2	0.3	0.4			
	$(I^2t \text{ Off})$	Min. Trip Time(ms)	20	80	160	260	360			
		Max. Trip Time(ms)	80	140	240	340	440			

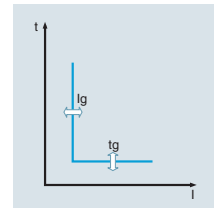

EARTH LEAKAGE (OPTION)										
<b>Current setting (A)</b>	$I_{\Delta n}$	0.5	1	2	3	5	10	20	30	Off
<b>Time delay (ms)</b>	$\Delta t$	Alarm Time(ms)	140	230	350	800	950			
		Trip Time(ms)	140	230	350	800				

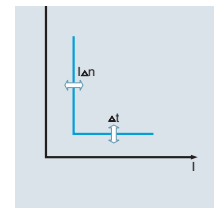

Note) Earth leakage function is available with ZCT or external CT

OTHER PROTECTION	PICK-UP			TIME DELAY(S)		
	SETTING RANGE	STEP	ACCURACY	SETTING RANGE	STEP	ACCURACY
<b>Under Voltage</b>	80V-0V_Pick-up	1V	±5%			
<b>Over Voltage</b>	UV_Pick-up~980V	1V	±5%	1.2~40 (s)		
<b>Voltage Unbalance</b>	6%~99%	1%	±2.5% or (*±10%)			
<b>Reverse Power</b>	10~500kW	1kW	±10%	0.2~40 (s)		
<b>Over Power</b>	500~5000W	1kW	±10%		0.1 (s)	±0.1 (s)
<b>Current Unbalance</b>	6%~99%	1%	±2.5% or (*±10%)			
<b>Over Frequency</b>	60Hz	UF_Pick-up~65	1Hz	±0.1Hz		
	50Hz	UF_Pick-up~55	1Hz	±0.1Hz	1.2~40 (s)	
<b>Under Frequency</b>	60Hz	55Hz~OF_Pick-up	1Hz	±0.1Hz		
	50Hz	45Hz~OF_Pick-up	1Hz	±0.1Hz		

## TRIP UNITS FOR UTS800 AND UTS1200

### S type: Supreme meter type

- Overload protection
  - Long-time delay
  - Thermal
- Short-circuit protection
  - Short-time delay/ Instantaneous
  - I<sup>2</sup>t On/Off optional (for short-time delay)
- Ground fault protection
  - I<sup>2</sup>tOn/Off optional
- Protection for Over voltage/Under voltage/Over frequency/Under frequency/Unbalance/Reverse power
- Realization of protective coordination by ZSI (Zone Selective Interlocking)
- The fine-adjustable setting by knob and key
- IDMTL setting (SIT, VIT, EIT, DT curve)
  - Basic setting: "None".Thermal curve.
- Measurement and Display Function
  - High detailed measurement for 3 phase current/ Voltage/ Power/Energy/Phase angle/Frequency/PF/Demand
  - 128 x 128 Graphic LCD
  - Indicates current/Voltage Vector Diagram and Waveform
- Fault recording
  - Records Max. up to 256 fault information about fault type, fault phase, fault value, occurrence time of fault
  - fault wave recording: records the latest fault wave
- Event recording
  - Records events of device related to setting change, operation and state change. (Max. up to 256)
- SBO (Select Before Operation)
  - High reliability for control and setting change method
- Power quality analysis
  - Measurement for 1st-63th harmonics
  - THD, TDD, k-Factor
  - Voltage/Current waveform capture
- 3 DO(Digital output)
  - Programmable for alarm, trip and general DO
- Communication
  - Modbus/RS485
  - Profibus-DP
- ERMS
  - Arc Flash Reduction
  - Instantaneous setting value is minimized. (2\*In)

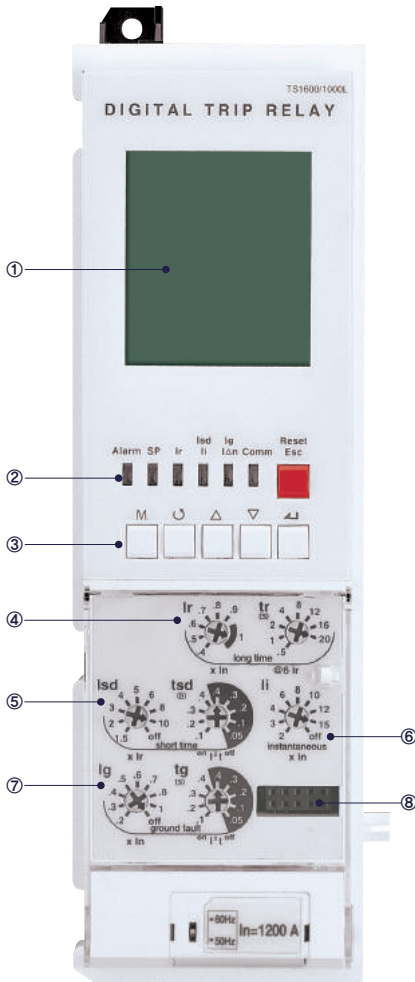

① **Graphic LCD:** Indication of measurement and information

② **LED:** Indication of trip info, and overload state

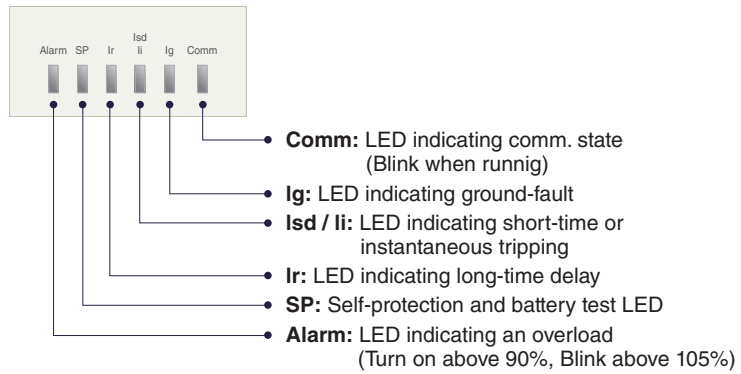

③ **Key:** Move to menu of reset

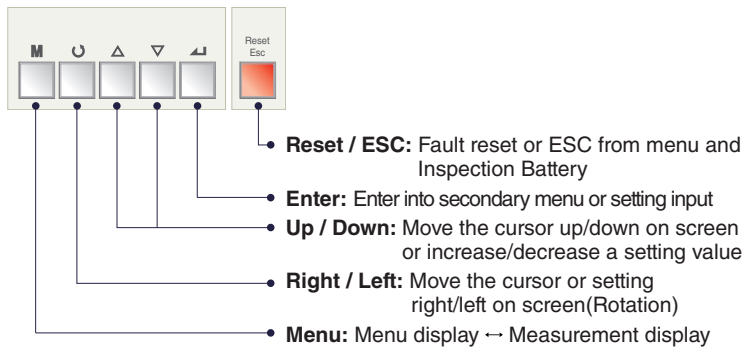

④ **I<sub>u</sub>, I<sub>r</sub>:** Long-time current setting, **tr:** Long-time tripping delay setting

⑤ **I<sub>sd</sub>, I<sub>r</sub>:** Short-time current setting, **tsd:** Short-time tripping delay setting

⑥ **I<sub>i</sub>:** Instantaneous current setting

⑦ **I<sub>g</sub>:** Ground fault setting, **tg:** Ground fault tripping delay setting

⑧ **Test terminal:** OCR test terminal (Connected with OCR tester)

**PROTECTION**

LONG TIME										
<b>Current setting (A)</b>	$I_u = I_n \times \dots$	0.4	0.5	0.6	0.7	0.8	0.9	1.0		
<b>Time delay (s)</b>	$t_r @ (1.5 \times I_r)$	12.5	25	50	100	200	300	400	500	
<b>Accuracy: ±15% or below 100ms</b>	$t_r @ (6.0 \times I_r)$	0.5	1	2	4	8	12	16	20	
	$t_r @ (7.2 \times I_r)$	0.34	0.69	1.38	2.7	5.5	8.3	11	13.8	

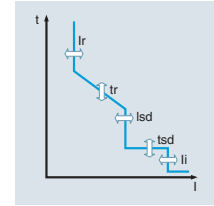

SHORT TIME										
<b>Current setting (A)</b>	$I_{sd} = I_r \times \dots$	1.5	2	3	4	5	6	8	10	Off
<b>Time delay (s) @ 10 x Ir</b>	$I^2t$ Off	$t_{sd}$	0.05	0.1	0.2	0.3	0.4			
		$I^2t$ On		0.1	0.2	0.3	0.4			
	$(I^2t \text{ Off})$	Min. Trip Time(ms)	20	80	160	260	360			
		Max. Trip Time(ms)	80	140	240	340	440			

INSTANTANEOUS										
<b>Current setting (A)</b>	$I_i = I_n \times \dots$	2	3	4	6	8	10	12	15	Off
<b>Tripping time</b>		50(±10)ms								

GROUND FAULT										
<b>Pick-up (A)</b>	$I_g = I_n \times \dots$	0.2	0.3	0.4	0.5	0.6	0.7	0.8	1.0	Off
<b>Time delay (s) @ 1 x In</b>	$I^2t$ Off	$t_g$	0.05	0.1	0.2	0.3	0.4			
		$I^2t$ On		0.1	0.2	0.3	0.4			
	$(I^2t \text{ Off})$	Min. Trip Time(ms)	20	80	160	260	360			
		Max. Trip Time(ms)	80	140	240	340	440			

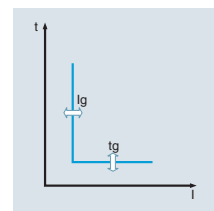

EARTH LEAKAGE (OPTION)										
<b>Current setting (A)</b>	$I_{\Delta n}$	0.5	1	2	3	5	10	20	30	Off
<b>Time delay (ms)</b>	$\Delta t$	Alarm Time(ms)	140	230	350	800	950			
		Trip Time(ms)	140	230	350	800				

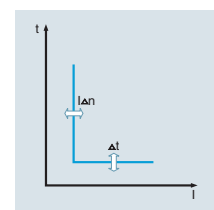





Note) Earth leakage function is available with ZCT or external CT

OTHER PROTECTION	PICK-UP			TIME DELAY (s)		
	SETTING RANGE	STEP	ACCURACY	SETTING RANGE	STEP	ACCURACY
<b>Under Voltage</b>	80V-0V_Pick-up	1V	±5%			
<b>Over Voltage</b>	UV_Pick-up~980V	1V	±5%	1.2~40 (s)		
<b>Voltage Unbalance</b>	6%~99%	1%	±2.5% or (*±10%)			
<b>Reverse Power</b>	10~500kW	1kW	±10%			
<b>Over Power</b>	500~5000W	1kW	±10%	0.2~40 (s)		
<b>Current Unbalance</b>	6%~99%	1%	±2.5% or (*±10%)		0.1 (s)	±0.1 (s)
<b>Over Frequency</b>	60Hz	UF_Pick-up~65	1Hz	±0.1Hz		
	50Hz	UF_Pick-up~55	1Hz	±0.1Hz	1.2~40 (s)	
<b>Under Frequency</b>	60Hz	55Hz~OF_Pick-up	1Hz	±0.1Hz		
	50Hz	45Hz~OF_Pick-up	1Hz	±0.1Hz		



# TRIP UNITS FOR UTS800 AND UTS1200

## TRIP RELAY TYPES

CLASSIFICATION	N TYPE	A TYPE	P TYPE	S TYPE
<b>Externals</b>				
<b>Current protection</b>	<ul style="list-style-type: none"> <li>L / S / I / G Thermal</li> </ul>	<ul style="list-style-type: none"> <li>L / S / I / G / Thermal</li> <li>ZSI(Protective coordination)</li> <li>ERMS</li> </ul>	<ul style="list-style-type: none"> <li>L / S / I / G / Thermal(Continuous)</li> <li>ZSI(Protective coordination)</li> <li>ERMS</li> </ul>	<ul style="list-style-type: none"> <li>L / S / I / G / Thermal(Continuous)</li> <li>ZSI(Protective coordination)</li> <li>ERMS</li> </ul>
<b>Other protection</b>	-	<ul style="list-style-type: none"> <li>Earth leakage (Option)</li> </ul>	<ul style="list-style-type: none"> <li>Earth leakage (Option)</li> <li>Over/Under voltage</li> <li>Unbalance(Voltage/Current)</li> <li>Reverse power/Over power</li> </ul>	<ul style="list-style-type: none"> <li>Earth leakage (Option)</li> <li>Over/Under voltage</li> <li>Unbalance(Voltage/Current)</li> <li>Reverse power/Over power</li> </ul>
<b>Measurement function</b>	-	<ul style="list-style-type: none"> <li>Current (R / S / T )</li> </ul>	<ul style="list-style-type: none"> <li>3 Phase Voltage/Current RMS/Vector</li> <li>Power(P, Q, S), PF(3-Phase)</li> <li>Energy(Positive/Negative)</li> <li>Frequency, Demand</li> </ul>	<ul style="list-style-type: none"> <li>3 Phase Voltage/Current RMS/Vector</li> <li>Power(P, Q, S), PF(3-Phase)</li> <li>Energy(Positive/Negative)</li> <li>Frequency, Demand</li> <li>Voltage/Current harmonics (1st-63th)</li> <li>3 Phase Waveforms</li> <li>THD, TDD, K-Factor</li> </ul>
<b>Fine adjustment</b>	-	-	<ul style="list-style-type: none"> <li>Fine adjustment for long/short time delay/instantaneous/ ground</li> </ul>	<ul style="list-style-type: none"> <li>Fine adjustment for long/short time delay/instantaneous/ ground</li> </ul>
<b>Digital Output</b>	-	<ul style="list-style-type: none"> <li>3DO (Fixed)</li> <li>L, S/I, G Alarm</li> </ul>	<ul style="list-style-type: none"> <li>3DO (Programmable)</li> <li>Trip, Alarm, General</li> </ul>	<ul style="list-style-type: none"> <li>3DO (Programmable)</li> <li>Trip, Alarm, General</li> </ul>
<b>IDMTL setting</b>	-	-	<ul style="list-style-type: none"> <li>Compliance with IEC60255-3</li> <li>SIT, VIT, EIT, DT</li> </ul>	<ul style="list-style-type: none"> <li>Compliance with IEC60255-3</li> <li>SIT, VIT, EIT, DT</li> </ul>
<b>Communication</b>	-	<ul style="list-style-type: none"> <li>Modbus/RS-485</li> <li>Profibus-DP</li> </ul>	<ul style="list-style-type: none"> <li>Modbus/RS-485</li> <li>Profibus-DP</li> </ul>	<ul style="list-style-type: none"> <li>Modbus/RS-485</li> <li>Profibus-DP</li> </ul>
<b>Power supply</b>	<ul style="list-style-type: none"> <li>Self Power</li> <li>- Power source works over 20% of load current.</li> </ul>	<ul style="list-style-type: none"> <li>Self Power</li> <li>- Power source works over 20% of load current.</li> <li>- External power source are required for comm.</li> <li>AC/DC 100~250V</li> <li>DC 24~60V</li> </ul>	<ul style="list-style-type: none"> <li>AC/DC 100~250V</li> <li>DC 24~60V</li> </ul>	<ul style="list-style-type: none"> <li>AC/DC 100~250V</li> <li>DC 24~60V</li> </ul>
<b>RTC timer</b>	-	<ul style="list-style-type: none"> <li>Available</li> </ul>	<ul style="list-style-type: none"> <li>Available</li> </ul>	<ul style="list-style-type: none"> <li>Available</li> </ul>
<b>LED for trip info.</b>	<ul style="list-style-type: none"> <li>Long time delay</li> <li>Short time delay/Instantaneous</li> <li>Ground fault</li> </ul>	<ul style="list-style-type: none"> <li>Long time delay</li> <li>Short time delay/Instantaneous</li> <li>Ground fault</li> </ul>	<ul style="list-style-type: none"> <li>Long time delay</li> <li>Short time delay/Instantaneous</li> <li>Ground fault</li> </ul>	<ul style="list-style-type: none"> <li>Long time delay</li> <li>Short time delay/Instantaneous</li> <li>Ground fault</li> </ul>
<b>Fault recording</b>	-	<ul style="list-style-type: none"> <li>10 records (Fault/Current/Date and Time)</li> </ul>	<ul style="list-style-type: none"> <li>256 records (Fault/Current/Date and Time)</li> </ul>	<ul style="list-style-type: none"> <li>256 records (Fault/Current/Date and Time)</li> </ul>
<b>Event recording</b>	-	-	<ul style="list-style-type: none"> <li>256 records (Content, Status, Date)</li> </ul>	<ul style="list-style-type: none"> <li>256 records (Content, Status, Date)</li> </ul>
<b>Operating button</b>	<ul style="list-style-type: none"> <li>Reset button</li> </ul>	<ul style="list-style-type: none"> <li>Reset, Menu</li> <li>Up/Down, Left/Right, Enter</li> </ul>	<ul style="list-style-type: none"> <li>Reset, Menu</li> <li>Up/Down, Left/Right, Enter</li> </ul>	<ul style="list-style-type: none"> <li>Reset, Menu</li> <li>Up/Down, Left/Right, Enter</li> </ul>

Basic protection function(L / S / I / G) is still under normal operation without control power.

## OPERATION CHARACTERISTIC

### LONG-TIME DELAY (L)

The function for overload protection which has time delayed characteristic in inverse ratio to fault current.

- Standard current setting knob:  $I_r$ 
  - Setting range in P type and S type:  $(0.4-0.5-0.6-0.7-0.8-0.9-1.0) \times I_n$
  - Setting range in N type and A type:  $(0.4-1.0) \times I_n$ 
    - $I_u$ :  $(0.5-0.6-0.7-0.8-0.9-1.0) \times I_n$
    - $I_r$ :  $(0.8-0.83-0.85-0.88-0.9-0.93-0.95-0.98-1.0) \times I_n$
- Time delay setting knob:  $t_r$ 
  - Standard operating time is based on the time of  $6 \times I_r$
  - Setting range: 0.5-1-2-4-8-12-16-20 (s)
- Relay pick-up current
  - When current over  $(1.15) \times I_r$  flows in, relay is picked up.
- Relay operates basing on the largest load current among R/S/T phase.

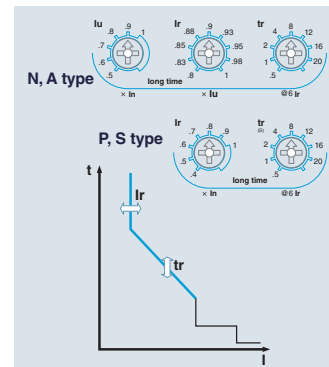

### SHORT-TIME DELAY (S)

The function for fault current (over current) protection which has definite time characteristic and time delayed in inverse ratio to fault current.

- Standard current setting knob:  $I_{sd}$ 
  - Setting range:  $(1.5-2-3-4-5-6-8-10-Off) \times I_r$
- Time delay setting knob:  $t_{sd}$ 
  - Standard operating time is based on the time of  $10 \times I_r$
  - Inverse time ( $I^2 t$  On): 0.1 - 0.2 - 0.3 - 0.4 (s)
  - Definite time ( $I^2 t$  Off): 0.05 - 0.1 - 0.2 - 0.3 - 0.4 (s)
- Relay operates based on the largest load current among R/S/T phase.
- When the ZSI function is set, the protection operation will take place instantaneously with input absence by downstream devices. It is advised to disable the ZSI function on the last downstream device.

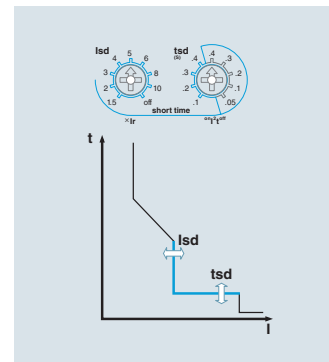

### INSTANTANEOUS (I)

The function for breaking fault current above the setting value within the shortest time to protect the circuit from short-circuit

- Standard current setting knob:  $I_i$ 
  - Setting range:  $(2-3-4-6-8-10-12-15-Off) \times I_n$
- Relay operates based on the largest load current among R/S/T phase.
- Total breaking time is below 50ms.
- When using the ERMS function, Instantaneous setting value is applied as  $2 \times I_n$  (N type OCR does not apply)

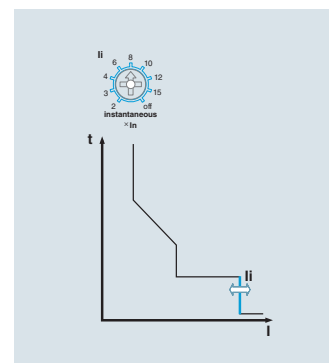

## OPERATION CHARACTERISTIC

### GROUND FAULT (G)

The function for breaking ground fault current above setting value after time-delay to protect the circuit from ground fault.

- Standard setting current knob:  $I_g$   
- Setting range: (0.2 - 0.3 - 0.4 - 0.5 - 0.6 - 0.7 - 0.8 - 1.0 - Off) x  $I_n$
- Time delay setting knob:  $t_g$   
- Inverse time ( $I^2t$  On): 0.1 - 0.2 - 0.3 - 0.4 (s)  
- Definite time ( $I^2t$  Off): 0.05 - 0.1 - 0.2 - 0.3 - 0.4 (s)
- Ground fault current is the vector sum of each phase current. Therefore, 3Pole products may operate under its phase-unbalance including ground fault situation. (R+S+T Phase)
- When the ZSI function is set, the protection operation will take place instantaneously with input absence by downstream devices. It is advised to disable the ZSI function on the last downstream device.
- Ground-fault functions are basically provided with products equipped with a trip relay through its internal CT that is embedded in each phase.  
(But, it can't be used with earth - leakage protection function at the same time)

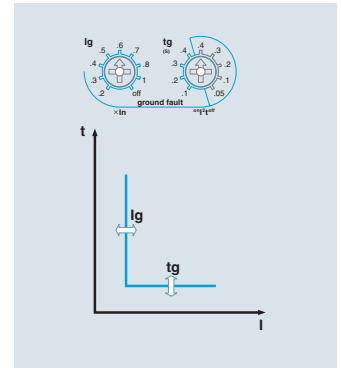

### EARTH LEAKAGE (G) - OPTION

The function for breaking earth leakage current above setting value after time delay to protect the circuit from earth leakage. (A, P, S type)

- Standard setting current knob:  $I_{\Delta n}$   
-Setting range: 0.5-1-2-3-5-10-20-30-OFF(A)
- Time delay setting knob:  $\Delta t$   
- Trip time: 140-230-350-800 ms  
- Alarm time: 140-230-350-800-950 ms
- Settings within its alarm range will prevent its breaker from tripping but activating its alarm.
- This function is enabled and can be used only with private external CT(secondary output 5A) selected by customers.
- When the ZSI function is set, the protection operation will take place instantaneously with input absence by downstream devices. It is advised to disable the ZSI function on the last downstream device.

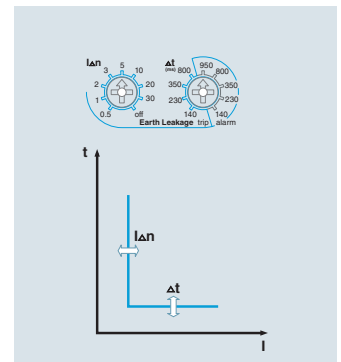

#### ※ USE CAUTIONS WITH EARTH-LEAKAGE CURRENT SETTINGS

- When using other CT selected by customers, the setting range is from 0.5 to 5A based on its secondary current. (Secondary output rating: 5A)  
Hence, under 100:5A CT, if trip relay is set to 0.5A, earth-leakage exceeding 10A will activate its operation (0.5A x 20=10A)

#### ※ GUIDELINES FOR USING AN EXTERNAL CT

- Earth-leakage protection characteristics using the standard CT which is installed inside of MCCB can protect currents from 20 to 100% range on its rated current.
- As rated currents on MCCB increases, current that is covered by its standard CT increase as well. This can not protect against small leakage currents.  
ex) 400A MCCB Min. Earth-leakage current 400A x 20%=80A
- Therefore, customers are advised to install an external CT in accordance with its rated currents within its systems. And choose trip relay(E, X type) which is required with CT usage in order to provide earth-leakage function.

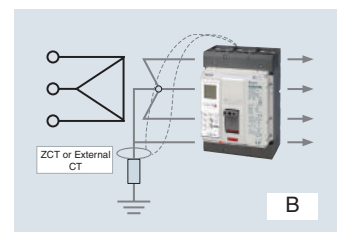
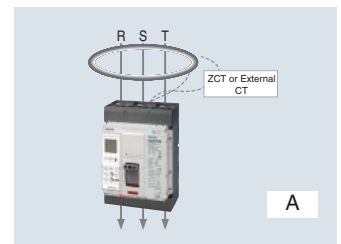

## MEASUREMENT FUNCTION

	CLASS.	MEASUREMENT ELEMENT	DETAILED ELEMENT	UNIT	DISPLAY RANGE	ACCURACY
A type	Current	Line current	Ia, Ib, Ic	A	80A~65,535A	±3%
		Normal current	I <sub>1</sub>			
		Reverse current	I <sub>2</sub>			
P type	Voltage	Line voltage	Vab, Vbc, Vca	V	60~690V	±1%
		Phase voltage	Va, Vb, Vc			±1%
		Normal voltage	V <sub>1</sub>			
		Reverse voltage	V <sub>2</sub>			
P type	Angle	Line-to-line	∠VabIa, ∠VablIb, ∠VabIc,	°	0~360°	±1°
		Line-to-current	∠VabVbc, ∠VabVca			±1°
		Phase-to-phase	∠VaVb, ∠VaVc			±1°
		Phase-to-current	∠VaIa, ∠VblIb, ∠VclIc			±1°
P type	Power	Active power	Pa(ab), Pb(bc), Pc(ca), P	kW	1kW~99,999kW	±3%
		Reactive power	Qa(ab), Qb(bc), Qc(ca), Q	kVar	1kVar~99,999kVar	±3%
		Apparent power	Sa(ab), Sb(bc), Sc(ca), S	kVA	1kVA~99,999kVA	±3%
P type	Energy	Active energy	WHa(ab), WHb(bc), WHc(ca), WH	kWh MWh	1kWh~9999.99MWh	±3%
		Reactive energy	VARHa(ab), VARHb(bc), VARHc(ca), VARH	kVarh Mvarh	1kVarh~9999.99MVarh	±3%
		Reverse active energy	rWHa(ab), rWHb(bc), rWHc(ca), rWH	kWh MWh	1kWh ~9999.99MWh	±3%
P type	Freq.	Frequency	F	Hz	45~65Hz	
P type	Power factor	Power factor(PF)	PFa(ab), PFb(bc), PFc(ca), PF		+: Lead, -: Lag	
P type	Unbalance	Unbalance rate	Iunbalance, Vunbalance	%	0.0~100.0	
P type	Demand	Active power demand	Peak demand	kW	1kW~99999kW	
		Current demand	Peak demand	A	80A~65,535A	
S type	Harmonics	Voltage harmonics	1st~63th harmonics of Va(ab), Vb(bc), Vc(ca)	V	60~690V	
		Current harmonics	1st~63th harmonics of Ia, Ib, Ic	A	80A~65,535A	
		THD, TDD		%	0.0~100.0	
		K-Factor		-	0.0~100.0	

### Voltage module

For P and S type Trip relay, separate voltage module is necessary to measure other element besides current (Separate purchase is needed)  
- Voltage input range: AC 60~690V

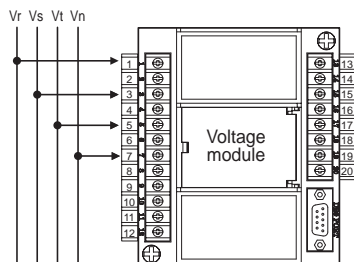

3P4W wiring

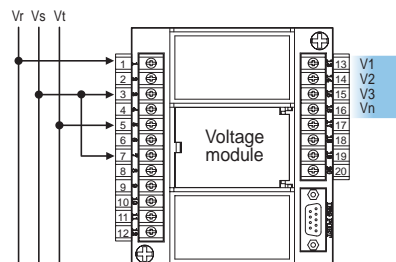

3P3W wiring

## ZSI - ZONE SELECTIVE INTERLOCKING (A, P, S TYPE)

**Zone-selective interlocking drops delay time that eliminates faults for breakers. It minimizes the shock that all kinds of electric machines get under fault conditions.**

1. In case of short time-delay or ground fault in a system where ZSI built in, the breaker at the point of failure generates a ZSI output signal to suppress the operation of upstream breaker.
2. To eliminate a breakdown, trip relay of MCCB at accident site activates trip operation without time delay.
3. The upstream breaker that received ZSI signal adhere to pre-set short time-delay or ground fault time-delay for protective coordination in the system. However upstream breaker that did not receive its signal will trip instantaneously.
4. For ordinary ZSI operation, it should arrange operation time accordingly so that downstream circuit breakers will react before upstream ones under overcurrent/short time delay/ground fault situations.
5. ZSI connecting line needs to be Max. 3m.

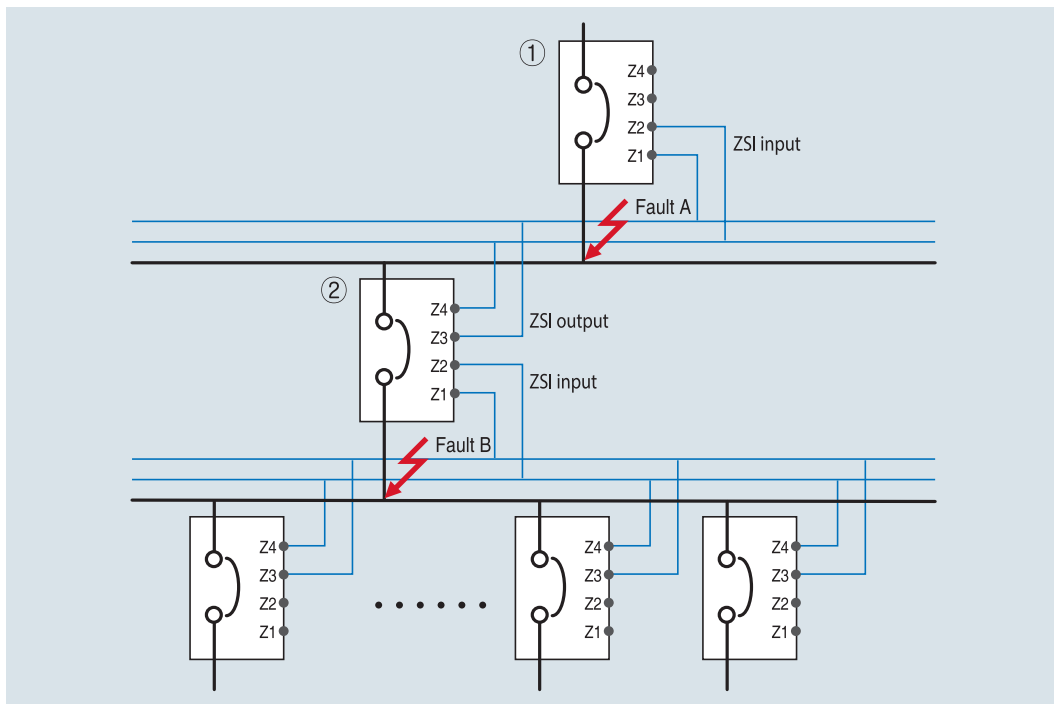

- 1) Occurrence of fault A
  - Only breaker ① performs instantaneous trip operation.
- 2) Occurrence of fault B
  - Breaker ② performs instantaneous trip operation, breaker ① performs trip operation after prearranged delay time
  - But if breaker ② did not break the fault normally, breaker ① performs instantaneous trip operation to protect system.

## REMOTE RESET AND DIGITAL I/O (A, P, S TYPE)

In case of an accident or overcurrent, the trip relay displays the accident information along with the contact output through LCD and LED.

A, P, S type Trip Relay enables remote reset through DI (Digital Input) input and provides 3 DO (Digital Output) outputs

- Methods to reset Trip relay is to push the Reset button on the frontal side and to use the remote reset.
- Digital input
  - [R11-R22] input: Remote reset
  - [Z1-Z2] Input: ZCT for earth leakage detection or external CT input
- ※ All DI are dry contact that has 3.3V of recognition voltage. When inputting close by SSR(Solid State Relay) or open-collector, connect collector(Drain) to R11.
- Digital output 3a(524, 534, 544-513)
  - Fault output: Long/Short time delay, Instantaneous, Ground fault, UVR, OVR, UFR, OFR, rPower, Vunbal, Iunbal (Maintains state as Latch form until user pushes reset.)
  - General DO: when setting L/R as remote, it is available to control close/open remotely by using communication.

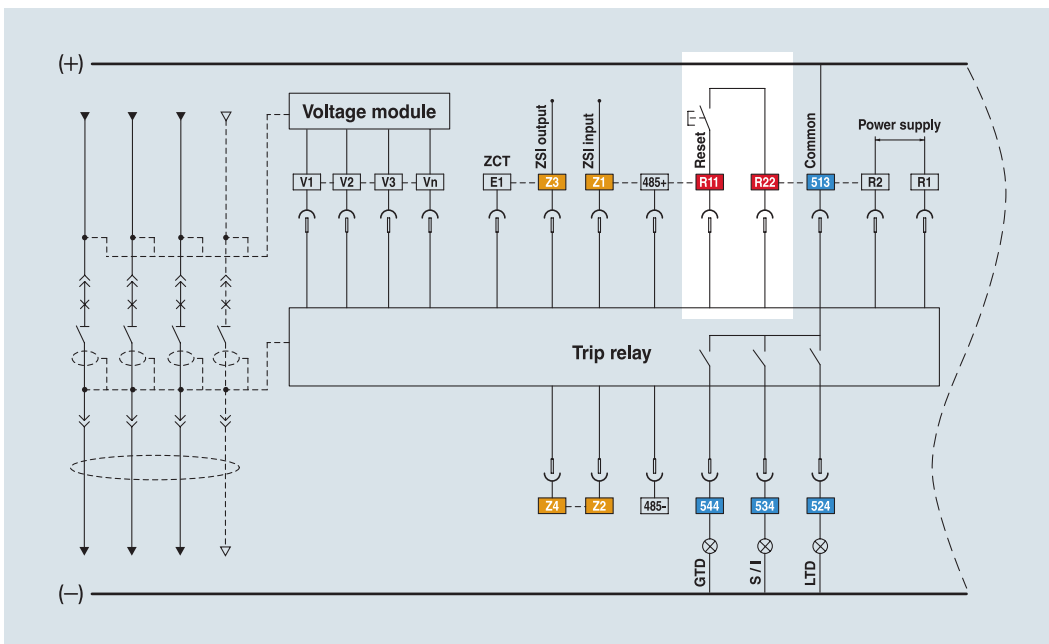

Trip Relay	Digital Output	Long time	Short time	Instantaneous	Ground	Overload Alarm	OVR	UVR	rPower	Vunbal	Iunbal	OFR	UFR	OPR	Note
P, S type	DO1(524)	●	○	○	○	○	○	○	○	○	○	○	○	○	Programmable
	DO2(534)	○	●	●	○	○	○	○	○	○	○	○	○	○	
	DO3(544)	○	○	○	●	○	○	○	○	○	○	○	○	○	
A type	DO1(524)	●	x	x	x	Not available									Fixed
	DO2(534)	x	●	●	x										
	DO3(544)	x	x	x	●										

## ERMS AND DIGITAL I/O (A, P, S TYPE)

**ERMS(Energy Reduction Maintenance Setting)** is a function to reduce the arc energy to ensure workers' safety. When using the ERMS function, the instantaneous setting value is minimized( $2 \cdot I_n$ ). A, P, and S type trip relays are able to perform the ERMS by digital input and have 3 DO (digital output).

1. To use the ERMS function, short both ends of ERMS terminal
2. Digital input
  - [R11-R22] input: ERMS
  - [Z1-Z2] Input: ZCT for earth leakage detection or external CT input
- ※ All DI are dry contact that has 3.3V of recognition voltage. When inputting close by SSR(Solid State Relay) or open-collector, connect collector(Drain) to R11.
3. Digital output 3a(524, 534, 544-513)
  - Fault output: Long/Short time delay, Instantaneous, Ground fault, UVR, OVR, UFR, OFR, rPower, Vunbal, Iunbal  
(Maintains state as Latch form until user pushes reset.)
  - General DO: when setting L/R as remote, it is available to control close/open remotely by using communication.

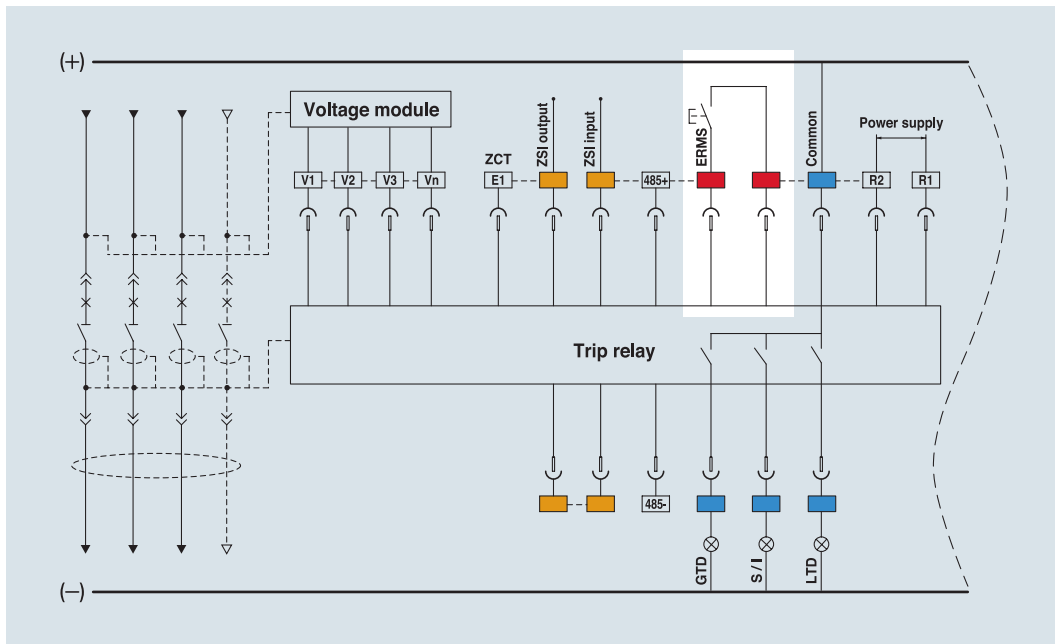



## COMMUNICATION

### Modbus/RS-485

- Operation mode: Differential
- Distance: Max. 1.2km
- Cable :  
General RS-485 shielded twist  
2-pair cable
- Baud rate :  
9600bps, 19200bps, 38400bps
- Transmission method: Half-Duplex
- Termination: 150Ω

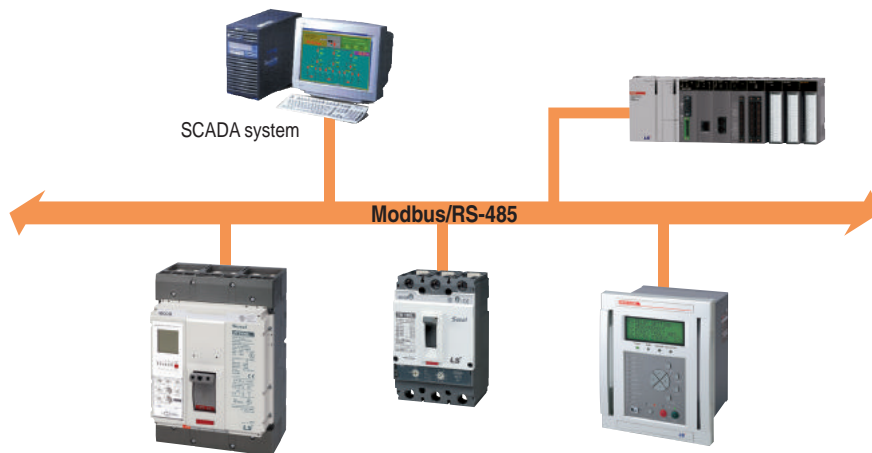

### Profibus-DP

- Profibus-DP module is installed separately (Option)
- Operation mode: Differential
- Distance: Max. 1.2km
- Cable :  
Profibus-DP shielded twist 2-pair cable
- Baud rate: 9600bps~12Mbps
- Transmission method: Half-Duplex
- Termination: 150Ω
- Standard: EN 50170 / DIN 19245



Profibus-DP  
communication module  
(Option)

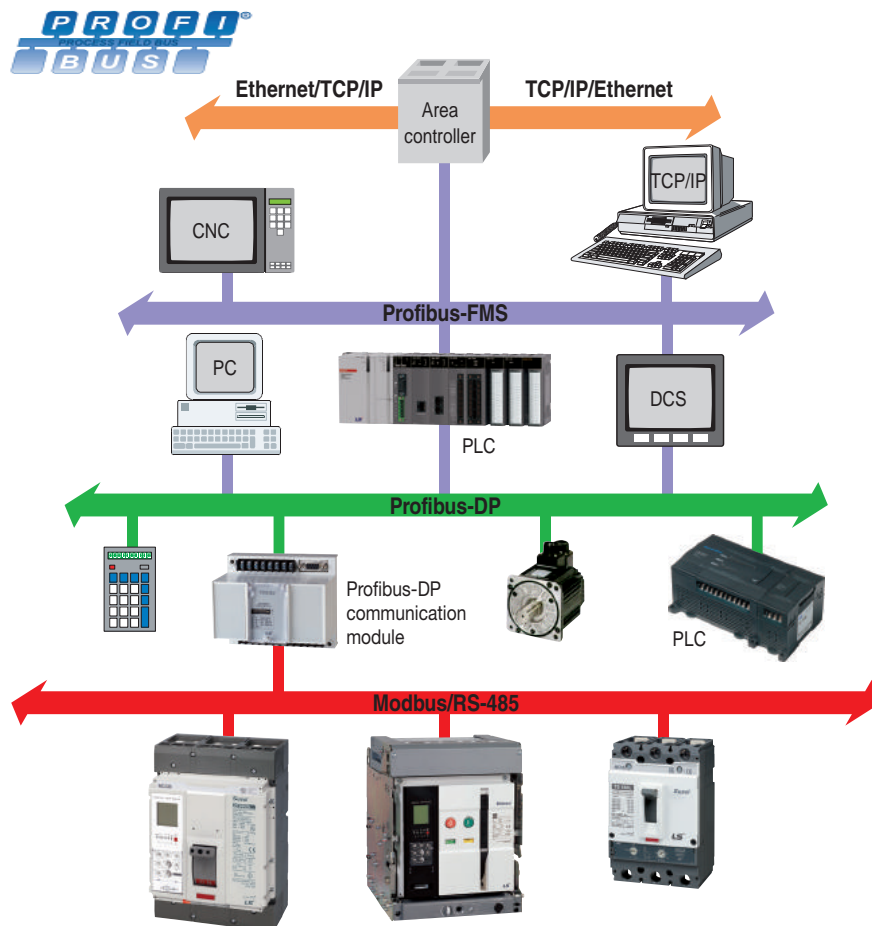

## EVENT & FAULT RECORDING (P, S TYPE)

P, S type Trip Relay records up to 256 information with ms time when an event such as device configuration change, information change, self-diagnostic error occurrence, or status change occurs. In addition, when a fault such as an operation or trip of a relay element occurs, detailed fault information such as an fault cause, fault phase, and an accident value can be stored up to 256 times (up to 10 for A-types) with ms information.

### Event information display

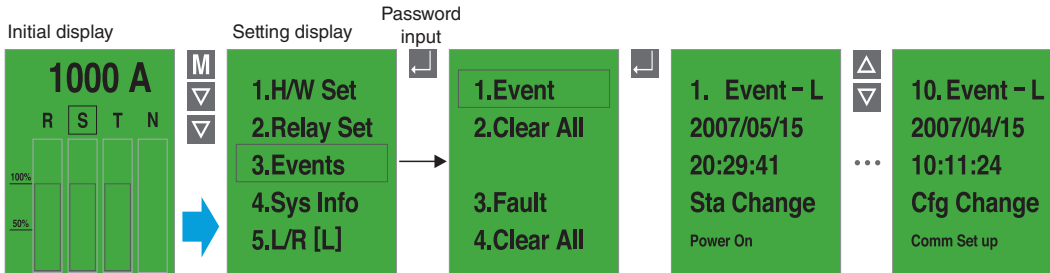

### Fault information display

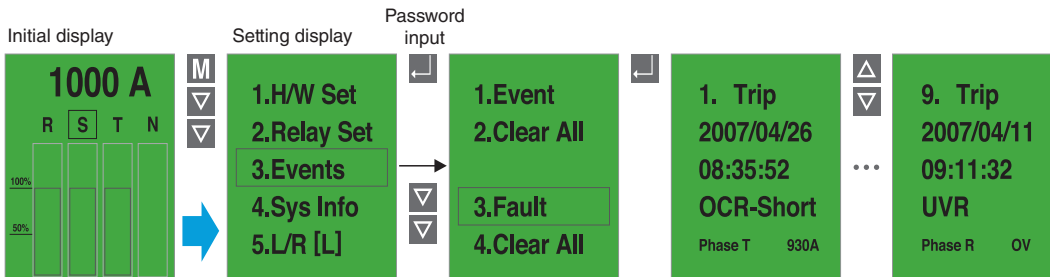

## SYSTEM INFORMATION

P and S type can indicate information as followings with the information of the MCCB.

- Present time: year/month/date/hour/minute/ms
- MCCB current ratings
- N-phase current ratings: 100%
- Frequency information: 60Hz / 50Hz
- Closing numbers of breaker: CB ON numbers
- Trip relay operating time: OCR ON time
- ON time of breaker: CB ON time
- S/W ver. information

### System information display

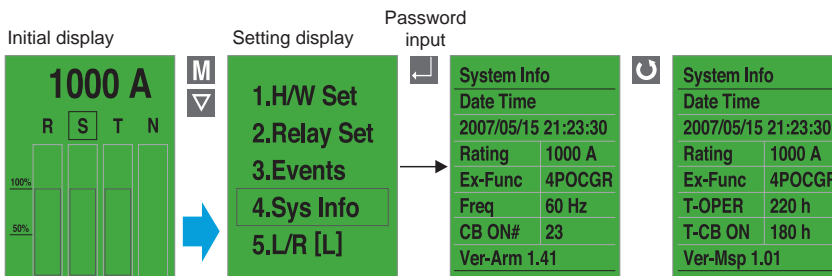

# SYSTEM BLOCK DIAGRAM

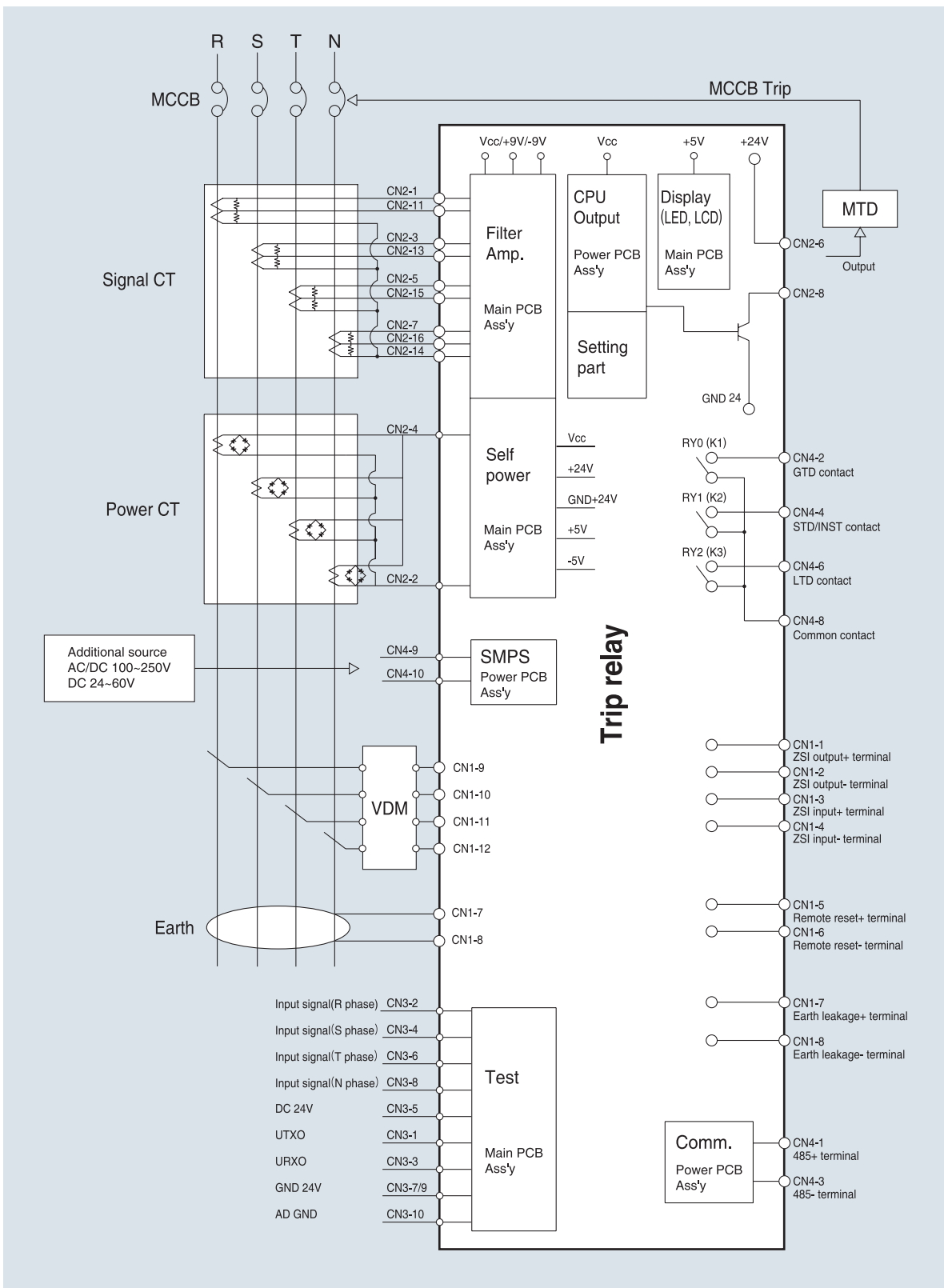

# INSTALLATION AND HANDLING

## Withdrawal Wiring for Trip Relay

**Caution**

1. In case of disassembling and assembling the main cover, screw should be tightened in specific torque of 1.5N.m (15.3kgf.cm)
2. In case of disassembling and assembling the main cover by over tightening torque, the parts of MCCB can be damaged.

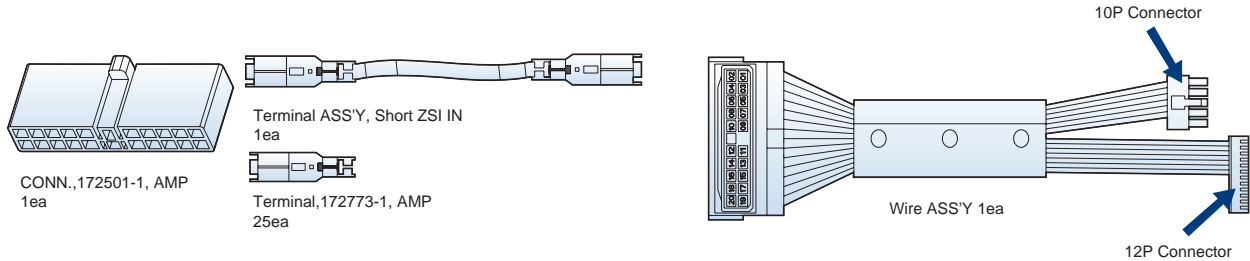

### WIRE ASS'Y OCR types

No.	Drawing No.	Part Name	Functions	OCR
1	76671176310	WIRE ASS'Y AG AC OCR	Communication, Digital Output, ZSI, Remote Reset	A Type
2	76671176311	WIRE ASS'Y A ZK PS CKA OCR	Communication, Digital Output, ZSI, Remote Reset, Earth Leakage(<30A), Voltage Module	P, S Type
3	76671176312	WIRE ASS'Y AE AX PX SX OCR	Communication, Digital Output, ZSI, Remote Reset, Earth Leakage(>30A), Voltage Module	P, S Type

## Components of wire ass'y OCR and types

### Terminal number and Description

Number	Marking	Description
01	485+	Comm. +
02	485-	Comm. -
03	R1	Power +
04	R2	Power -
05	524	Relay Output (Long time)
06	534	Relay Output (Short time/Instantaneous)
07	544	Relay Output (Ground fault/PAL)
08	513	Relay Output Common
09	Z3	ZSI Out +
10	Z4	ZSI Out -
11	Z1	ZSI In +
12	Z2	ZSI In -
13	R11	Remote Reset +
14	R22	Remote Reset -
15	E1 or B1	Earth Leakage +
16	E2 or B2	Earth Leakage -
17	V1	VR Input
18	V2	VS Input
19	V3	VT Input
20	VN	V Input Common

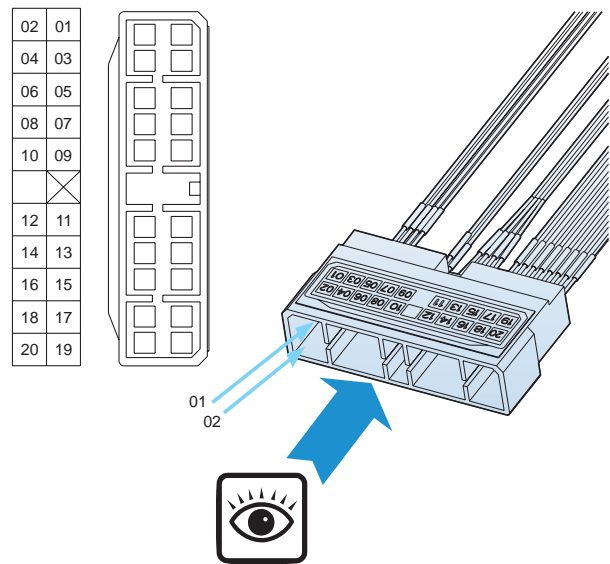

## INSTALLATION AND HANDLING

### 1. Disassembling cover and short connector

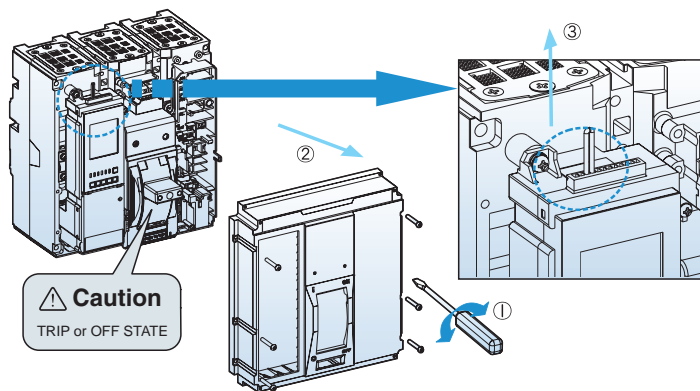

### In case of not using ZSI function

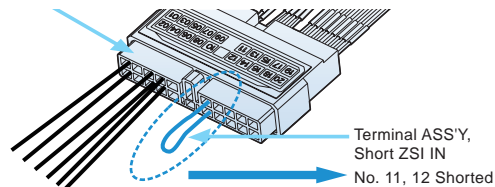

**Caution** : If not using ZSI function of Trip Relay (OCR), please short ZSI INPUT of terminal No.11,12 (ZSI IN +, ZSI IN -) by using the "TERMINAL ASS'Y, SHORT ZSI IN"

### 2. Assembly of wire ass'y and withdrawal of wire

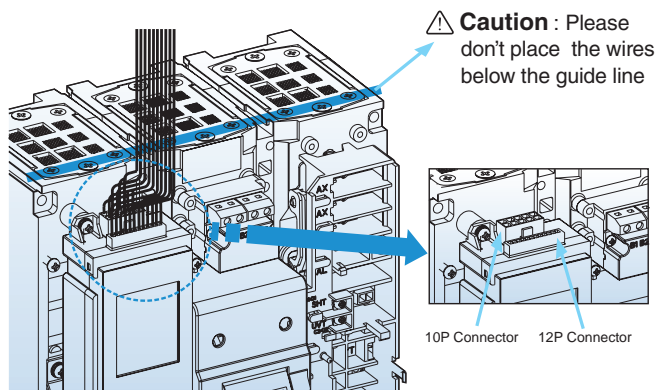

### In case of the wiring of Earth Leakage $\geq 30A$

Drawing No.	Part Name
76671176312	WIRE ASS'Y AE AX PX SX OCR

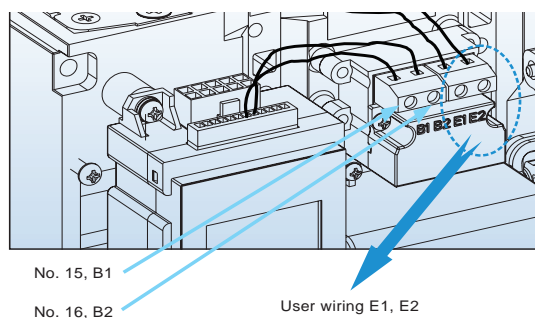

## Installation of withdrawal wiring for Trip Relay

### Trip Relay (OCR) type and applied wire ass'y

No	Type	WIRE ASS'Y, [ ], OCR, UTS1200		
		[AG AC] 76671176310	[A ZK PS CKA] 766711762311	[AE AX PX SX] 76671176312
1	NG0			
2	NG5			
3	AG0			
4	AG1	■		
5	AG2	■		
6	AG5			
7	AG6	■		
8	AG7	■		
9	AE0			
10	AE1			■
11	AE2			■
12	AE5			
13	AE6			■
14	AE7			■
15	AC1	■		
16	AC2	■		
17	AC6	■		
18	AC7	■		
19	AX1			■

No	Type	WIRE ASS'Y, [ ], OCR, UTS1200		
		[AG AC] 76671176310	[A ZK PS CKA] 766711762311	[AE AX PX SX] 76671176312
20	AX2			■
21	AX6			■
22	AX7			■
23	PC1		■	
24	PC2		■	
25	PC6		■	
26	PC7		■	
27	PX1			■
28	PX2			■
29	PX6			■
30	PX7			■
31	SC1		■	
32	SC2		■	
33	SC6		■	
34	SC7		■	
35	SX1			■
36	SX2			■
37	SX6			■
38	SX7			■

# MCCB FOR UL489 DC APPLICATION



Frame		UTE100		UTE100		UTS150			UTS250		
Maximum Rated Current		100A		100A		150A			250A		
Number of Poles		2		3		2, 3			2, 3		
Breaker Type		E	N	E	N	N	H	L	N	H	L
<b>UL489 DC</b>		<b>UTE100</b>		<b>UTE100</b>		<b>UTS150</b>			<b>UTS250</b>		
Interrupting Capacity (kA) DC UL, CSA	250V dc-2P	16	25	16	25	35	50	65	35	50	65
	500V dc-3P	-	-	25	35	-	-	-	-	-	-
	600V dc-3P	-	-	-	-	35	50	65	35	50	65
TRIP UNITS	Amperes	15~100A		15~100A		40~150A			150~250A		
F : Fixed	ATU	-		-		●			●		
A : Adjustable	FMU	-		●		●			●		
T : Thermal	FTU	●		●		●			●		
M : Magnetic	Amperes	100A		100A		150A			250A		
MCS	MCS	●		●		●			●		
Unit Mounted		●		●		●			●		
Mechanical Lugs		●		●		●			●		
Busbar connectors		●		●		●			●		
Control Wire Terminal Kit		-		-		●			●		
Terminal Shields		-		-		-			-		
Interphase Barriers		●		●		●			●		
Shunt Trip		●		●		●			●		
Undervoltage Trip		●		●		●			●		
Auxiliary Switch		●		●		●			●		
Alarm Switch		●		●		●			●		
Flange Cable Handle		●		●		●			●		
Flange Variable-Depth Mechanism		●		●		●			●		
Directly-Mounted Rotary Operating Handle		-		●		●			●		
NEMA-Door-Mounted Operating Mechanisms		●		●		●			●		
IEC-Door-Mounted Operating Mechanisms		●		●		●			●		
Mechanical Interlocks		-		●		●			●		
Handle Padlock Attachment		●		●		●			●		
Weight(approximate) lbs.(kg)	2-Pole	1.64(0.74)		-		3.44(1.56)			3.88(1.76)		
	3-Pole	-		2.33(1.06)		3.95(1.79)			4.49(2.04)		
Dimensions Inches(mm)	poles	<b>W</b>	<b>H</b>	<b>D</b>	<b>W</b>	<b>H</b>	<b>D</b>	<b>W</b>	<b>H</b>	<b>D</b>	
	2-Pole	2.01(51)	5.12(130)	3.44(87.5)	4.13(105)	6.50(165)	3.44(87.5)	4.13(105)	7.48(190)	3.44(87.5)	
	3-Pole	2.99(76)	5.12(130)	3.44(87.5)	4.13(105)	6.50(165)	3.44(87.5)	4.13(105)	7.48(190)	3.44(87.5)	

Note1) TS800U 700A: Only FTU





# ACCESSORIES

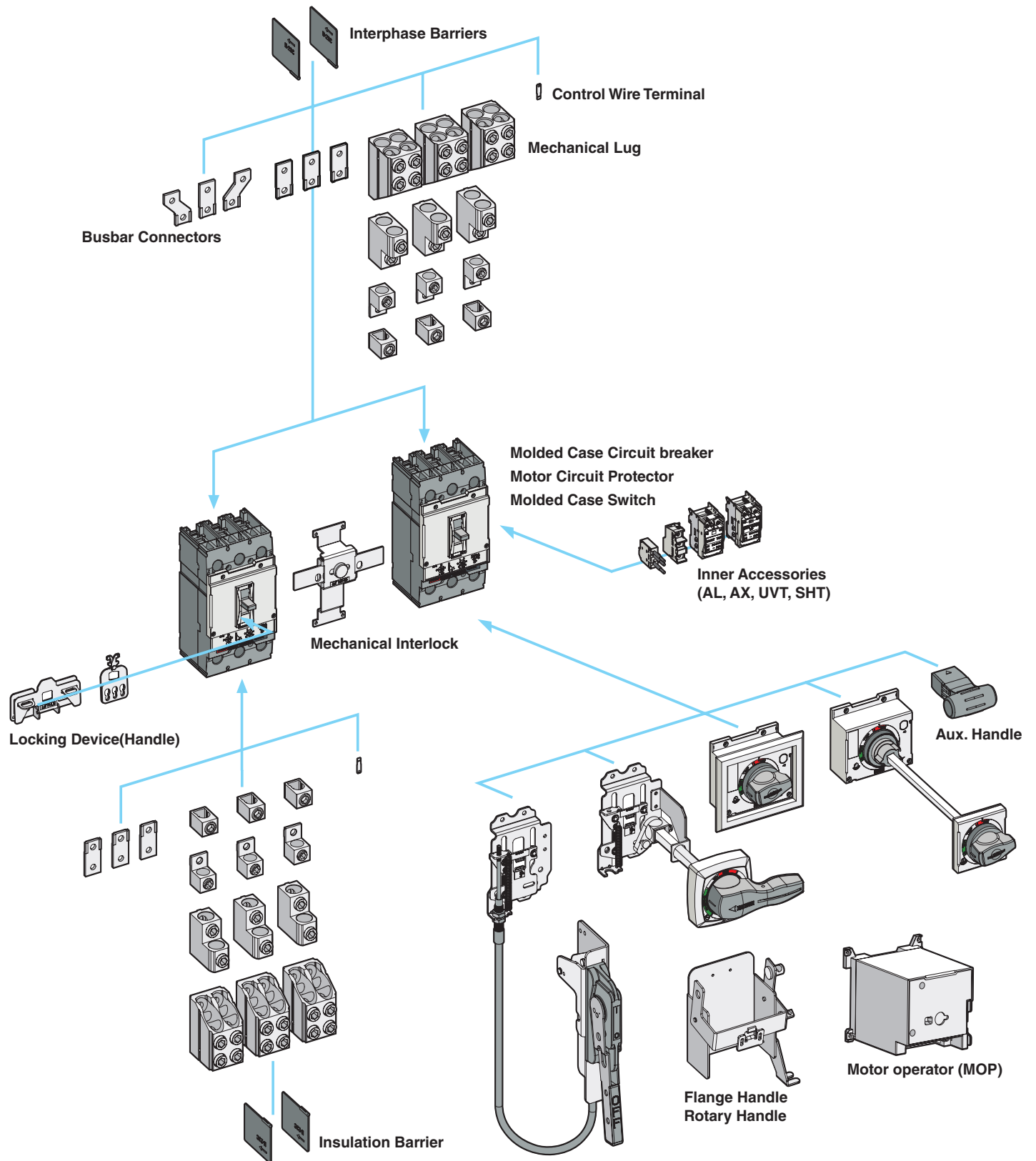

## MECHANICAL LUG OVERVIEW

UTE100 to UTS1200 frame circuit breakers can be ordered with mechanical line and load side lugs. The standard lugs can be removed for the installation of bus connections. All lugs are UL/cUL Listed Certified for their proper application and marked for use with aluminum and copper (Al/Cu) or copper only (Cu) conductors. Lugs suitable for copper and aluminum conductors are made of tin-plated aluminum. Mechanical lugs are sold either factory installed or as field installable kits.

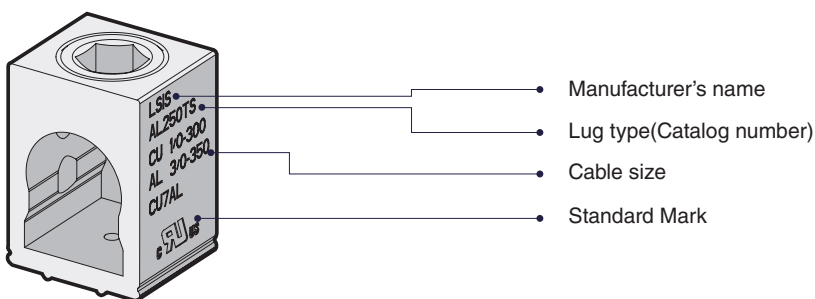

### MECHANICAL LUG KITS FOR UTE100 CIRCUIT BREAKERS

LUG TYPE	TERMINAL BODY MATERIAL	WIRE TYPE	BREAKER AMP RANGE	APPLICABLE WIRE (AWG)	TORQUE N-m (lb-in)	
AL 100TE	Aluminum	CU	15~30A	14~10	3.6 (31.9)	
			40A	8	4.5 (39.8)	
			50~80A	6~3	5.4 (47.8)	
			90~100A	2~1	6.3 (55.8)	
			15~30A	14~10	3.6 (31.9)	
			40~50A	8	4.5 (39.8)	
		AL	60 °C	60~100A	6~3	5.4 (47.8)
			75 °C	40~60A	6~3	5.4 (47.8)
				70~80A	2~1	6.3 (55.8)
				50~70A	6~3	5.4 (47.8)
			75 °C	80~100A	2~1/0	6.3 (55.8)

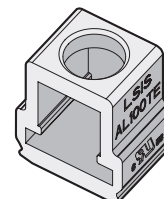

**AL100TE**  
15~100A LUG

### MECHANICAL LUG KITS FOR UTS150 CIRCUIT BREAKERS

LUG TYPE	TERMINAL BODY MATERIAL	BREAKER AMP RANGE	WIRE TYPE	APPLICABLE WIRE (AWG)	TORQUE N-m (lb-in)
AL150TS	Aluminum	1.6~15A	Cu	14	4.1 (36.2)
		20~30A	Cu	12~10	5.4 (47.8)
		40~175A	Cu	8~2/0	15.1 (133.6)
		50~70A	Al	6~3	5.4 (47.8)
		90~150A	Al	2~3/0	15.7 (138.6)

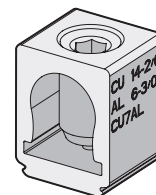

**AL150TS**  
1.6~150A LUG

## MECHANICAL LUG OVERVIEW

### MECHANICAL LUG KITS FOR UTS250 CIRCUIT BREAKERS

LUG TYPE	TERMINAL BODY MATERIAL	BREAKER AMP RANGE	WIRE TYPE	APPLICABLE WIRE (AWG)	TORQUE N·m (lb-in)
AL250TS	Aluminum	150~175A	Cu	1/0~4/0 AWG	32 (283.2)
		150~175A (Al) 200~225A (Cu)	Cu/Al	3/0~4/0 AWG	
		200~225A	Cu/Al	250~300kcmil	44 (389.4)
		250A	Cu	250~300kcmil	
		250A	Al	350kcmil	

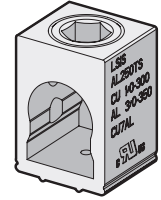

**AL250TS**  
150~250A LUG

### MECHANICAL LUG KITS FOR UTS400 CIRCUIT BREAKERS

LUG TYPE	TERMINAL BODY MATERIAL	BREAKER AMP RANGE	WIRE TYPE	APPLICABLE WIRE (AWG)	TORQUE N·m (lb-in)
AL400TS	Aluminum	250A 300A 350A 400A	Cu/Al	1/0AWG ~300kcmil	40.5 (358.5)
			Cu/Al	350~600kcmil	54 (478)
			Al *	700~750kcmil	54 (478)

\* Compact wire only (700~750kcmil)

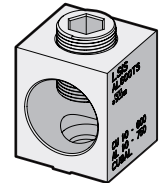

**AL400TS**  
250~400A LUG

### MECHANICAL LUG KITS FOR UTS600 CIRCUIT BREAKERS

LUG TYPE	TERMINAL BODY MATERIAL	BREAKER AMP RANGE	WIRE TYPE	APPLICABLE WIRE (AWG)	TORQUE N·m (lb-in)
AL600TS	Aluminum	500A 600A	Cu	2/0AWG ~350kcmil	40.5 (358.5)
			Al *	3/0AWG ~500kcmil	40.5 (358.5)

\* Compact wire only (400~500kcmil)

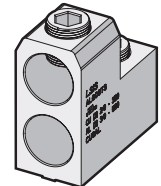

**AL600TS**  
500~600A LUG

### MECHANICAL LUG KITS FOR UTS800 CIRCUIT BREAKERS

LUG TYPE	TERMINAL BODY MATERIAL	BREAKER AMP RANGE	WIRE TYPE	APPLICABLE WIRE (AWG)	TORQUE N·m (lb-in)
AL800TS	Aluminum	400A 600A 630A 800A	Cu	3/0AWG ~300kcmil	45 (398.3)
			Al *	3/0AWG ~400kcmil	45 (398.3)

\* Compact wire only (350~400kcmil)

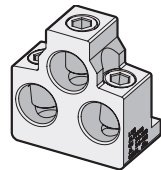

**AL800TS**  
400~800A LUG

### MECHANICAL LUG KITS FOR UTS1200 CIRCUIT BREAKERS

LUG TYPE	TERMINAL BODY MATERIAL	BREAKER AMP RANGE	WIRE TYPE	APPLICABLE WIRE (AWG)	TORQUE N·m (lb-in)
AL1200TS	Aluminum	800A 1000A 1200A	Cu	3/0AWG ~350kcmil	45 (398.3)
			Al *	3/0AWG ~500kcmil	45 (398.3)

\* Compact wire only (400~500kcmil)

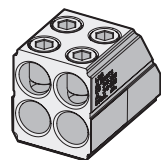

**AL1200TS**  
800~1200A LUG

## INTERNAL ACCESSORIES OVERVIEW

Field-installable accessories provide flexibility for installation at the point of use. Auxiliary switches, alarm switches, shunt trip, and undervoltage release accessories are easy to install, reliable, and common to all Susol molded case circuit breakers. The internal accessories comply with requirements of Underwriters Laboratories® Inc. UL 489 Standards

### ACCESSORY LOCATIONS

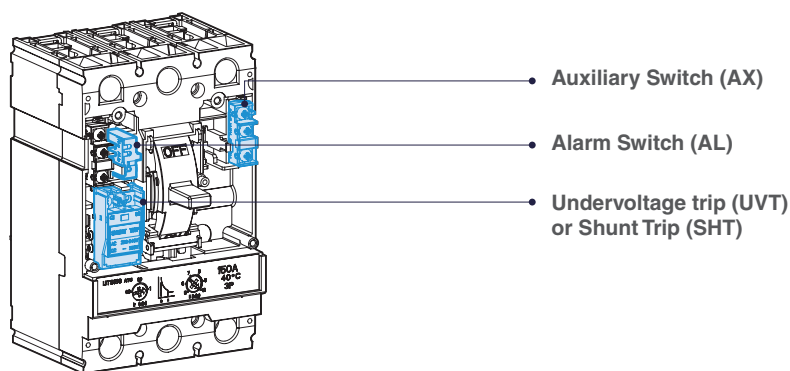

FRAME	INTERNAL ACCESSORIES LOCATIONS	TYPE	LEFT(R)	RIGHT(T)
UTE100	<p>* 2P : Right only</p> <ul style="list-style-type: none"> <li>AX or AL or AX+AL</li> <li>UVT or SHT or AX or AL or AX+AL</li> </ul>	AX	1*	1*
		AL	1*	1*
		AX+AL	1*	1*
		SHT	-	1*
		UVT	-	1*
UTS150 UTS250	<ul style="list-style-type: none"> <li>AX</li> <li>AX</li> <li>AL</li> <li>UVT or SHT</li> </ul>	AX	1	1
		AL	1	-
		SHT	1*	-
		UVT	1*	-
UTS400 UTS600	<ul style="list-style-type: none"> <li>AX</li> <li>AL</li> <li>UVT or SHT</li> </ul>	AX	3	-
		AL	-	1
		SHT	1*	-
		UVT	1*	-
UTS800 UTS1200	<ul style="list-style-type: none"> <li>AX</li> <li>AL</li> <li>UVT or SHT</li> </ul>	AX	-	3
		AL	-	1
		SHT	-	1*
		UVT	-	1*

\* Applicable in indicated pole position-not synchronous

### ACCESSORY CONNECTIONS

Electrical accessories are fitted with numbered terminal blocks for wires. Auxiliary circuit wiring exits fixed mounted devices through a knock-out in the front cover. The internal accessories comply with requirements of Underwriters Laboratories® Inc. UL 489 Standards

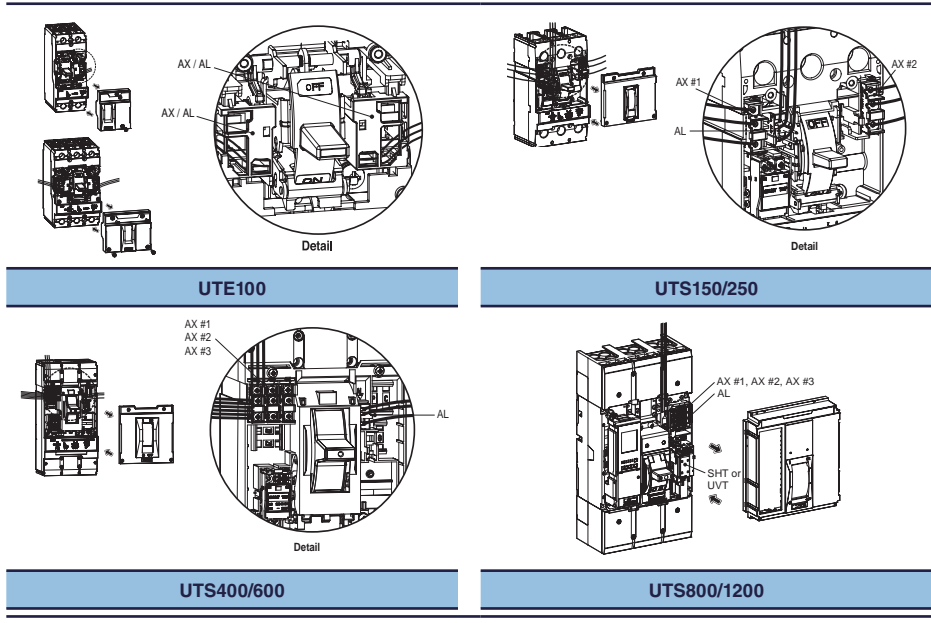

### AUXILIARY SWITCH (AX) AND ALARM SWITCH (AL)

Auxiliary switches provide remote information of the circuit breaker status and can be used for indications, electrical locking, relays, etc.

#### AUXILIARY SWITCH (AX):





Indicates the position of the circuit breaker contacts(Open/Closed)  
Auxiliary switch is for applications requiring remote “ON” and “OFF” indication.  
Each switch contains two contacts having a common connection.  
One is open and the other closed when the circuit breaker is open, and vice-versa.

AX	BREAKER TYPE	WIRE SIZE	ON	OFF/TRIP
	UTE100	24 AWG (0.2 mm <sup>2</sup> )		
	UTS150 UTS250 UTS400 UTS600	20 AWG (0.52 mm <sup>2</sup> )		
	UTS800 UTS1200	19~16 AWG (0.65~1.31 mm <sup>2</sup> )		

### ALARM SWITCH (AL):

Alarm switches indicate that the circuit breaker has tripped due to an overload, short circuit, shunt trip, or undervoltage trip or the “push-to-trip” button.

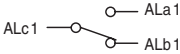
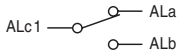
They are particularly useful in automated plants where operators must be signaled about changes in the electrical distribution system. This switch features a closed contact when the circuit breaker is tripped automatically. In other words, this switch does not function when the breaker is operated manually. Its contact is open when the circuit breaker is reset.

AL	BREAKER TYPE	WIRE SIZE	ON/OFF	TRIP
	UTE100	24 AWG (0.2 mm <sup>2</sup> )		
	UTS150 UTS250 UTS400 UTS600	26 AWG (0.13 mm <sup>2</sup> )		
	UTS800 UTS1200	24 AWG (0.2 mm <sup>2</sup> )		

### FAULT ALARM SWITCH (FAL):

FAL Indicates that the breaker has tripped due to overload or short circuit. And, it can be applied to only circuit breakers with electronic trip units.

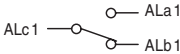
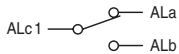
FAL	BREAKER TYPE	WIRE SIZE	ON/OFF	TRIP
	UTS150 UTS250 UTS400 UTS600	26 AWG (0.13 mm <sup>2</sup> )		

### TECHNICAL DATA

Conventional thermal current I <sub>th</sub>		5A			
Rated operational current I <sub>e</sub> with rated operational voltage U <sub>e</sub>	Voltage	I <sub>e</sub>		Minimum load current	
		Resistance	Inductance		
- Alternating current 50/60Hz AC	125V	5	3	5V DC 160mA 30V DC 30mA	UTE100
	250V	3	2		UTS150
	500V	-	-		UTS250
- Direct current DC	30V	4	3		UTS400
	125V	0.4	0.4		UTS600
	250V	0.2	0.2		UTS800 UTS1200

### SHUNT TRIP (SHT) AND UNDERVOLTAGE TRIP (UVT) SWITCHES

A voltage release can be used to trip the circuit breaker via a control signal.

#### SHUNT TRIP (SHT):

The shunt trip opens the mechanism in response to an externally applied voltage signal. The releases include coil clearing contacts that automatically clear the signal circuit when the mechanism has tripped.

#### UTE100 SHT

CONTROL VOLTAGE, U <sub>e</sub>		POWER CONSUMPTION		
		AC (VA)	DC (W)	mA
VOLTAGE	AC/DC 12V	0.35	0.36	30
	AC/DC 24V	0.64	0.65	27
	AC/DC 48V	1.09	1.1	23
	AC/DC 60V	1.2	1.22	20
	AC/DC 100~130V	0.73	0.75	5.8
	AC/DC 200~250V	1.21	1.35	5.4
	AC 380~450V	1.67	-	3.8
	AC 440~500V	1.68	-	3.5
Max.opening time		50ms (max.)		
Tightening torque of terminal screw		7.12 lb-in (0.8N-m)		
Operating voltage range		AC : 0.7~1.1V <sub>n</sub> , DC : 0.8~1.1V <sub>n</sub>		
Frequency		45Hz ~ 65 Hz (Only AC)		
Wire size		20 AWG (0.52 mm <sup>2</sup> )		



UTE100 SHT

#### UTS150/250/400/600 SHT

CONTROL VOLTAGE, U <sub>e</sub>		POWER CONSUMPTION		
		AC (VA)	DC (W)	mA
VOLTAGE	DC 12V	-	0.36	30
	AC/DC 24V	0.58	0.58	24
	AC/DC 48V	1.22	1.23	25
	AC/DC 110~130V	1.36	1.37	10.5
	AC 220~240V/DC 250V	1.8	1.88	7.5
	AC 380~500V	1.15	-	2.3
Max.opening time		50ms (max.)		
Tightening torque of terminal screw		7.12 lb-in (0.8N-m)		
Operating voltage range		0.7~1.1V <sub>n</sub>		
Frequency		45Hz ~ 65 Hz (Only AC)		
Wire size		20 AWG (0.52 mm <sup>2</sup> )		



UTS150/250/400/600 SHT

#### UTS800/1200 SHT

CONTROL VOLTAGE, U <sub>e</sub>		OPERATING VOLTAGE RANGE	POWER CONSUMPTION (VA or W)	
			INRUSH	STEADY-STATE
VOLTAGE	DC 24~30V	0.6~1.1V <sub>n</sub>	200	5
	AC 48V/DC 48~60V	0.6~1.1V <sub>n</sub>		
	AC/DC 100~130V	0.56~1.1V <sub>n</sub>		
	AC/DC 200~250V	0.56~1.1V <sub>n</sub>		
	AC 380~480V	0.56~1.1V <sub>n</sub>		
Max.opening time		40ms (max.)		
Frequency		45Hz~65Hz (Only AC)		
Wire size		16 AWG (1.31mm <sup>2</sup> )~14 AWG (2.08mm <sup>2</sup> )		



UTS800/1200 SHT



## UNDERVOLTAGE TRIP (UVT) :

The undervoltage release automatically opens a circuit breaker when voltage drops to a setting value of the line voltage. The operation is instantaneous, and after tripping, the circuit breaker cannot be re-closed again until the voltage returns to a recover value of line voltage.

Continuously energized, the undervoltage release must be operating before the circuit breaker can be closed.

### UTE100 UVT

CONTROL VOLTAGE, U <sub>e</sub>		POWER CONSUMPTION		
		AC (VA)	DC (W)	mA
VOLTAGE	AC/DC 24V	0.64	0.65	27
	AC/DC 48V	1.09	1.1	23
	AC/DC 100~110V	0.73	0.75	5.8
	AC/DC 200~220V	1.21	1.35	5.4
	AC 380~440V	1.67	-	3.8
	AC 440~480V	1.68	-	3.5
Max.opening time		50ms (max.)		
Tightening torque of terminal screw		7.12 lb-in (0.8N-m)		
Operating voltage range	Trip	0.2~0.7Vn		
	Reset/Closing	≥ 0.85Vn		
Frequency		45Hz ~ 65Hz (Only AC)		
Wire size		20 AWG (0.52 mm <sup>2</sup> )		



UTE100 UVT

### UTS150/250/400/600 UVT

CONTROL VOLTAGE, U <sub>e</sub>		POWER CONSUMPTION		
		AC (VA)	DC (W)	mA
VOLTAGE	AC/DC 24V	0.64	0.65	27
	AC/DC 48V	1.09	1.1	23
	AC/DC 110~130V	0.73	0.75	5.8
	AC 220~240V/DC 250V	1.21	1.35	5.4
	AC 380~440V	1.67	-	3.8
	AC 440~480V	1.68	-	3.5
Max.opening time		50ms (max.)		
Tightening torque of terminal screw		7.12 lb-in (0.8N-m)		
Operating voltage range	Trip	0.35~0.7Vn		
	Reset/Closing	≥ 0.85Vn		
Frequency		45Hz ~ 65 Hz (Only AC)		
Wire size		20 AWG (0.52 mm <sup>2</sup> )		



UTS150/250/400/600 UVT

### UTS800/1200 UVT

CONTROL VOLTAGE, U <sub>e</sub>		POWER CONSUMPTION (VA or W)		MAX.OPENING TIME (ms)
		INRUSH	STEADY-STATE	
VOLTAGE	DC 24~30V	200	5	50ms (max.)
	AC 48V/DC 48~60V			
	AC/DC 100~130V			
	AC/DC 200~250V			
	AC 380~480V			
Operating voltage range	Trip	0.44~0.6Vn		
	Reset/Closing	0.65~0.85Vn		
Frequency		45Hz~65Hz (Only AC)		
Wire size		16 AWG (1.31mm <sup>2</sup> )~ 14 AWG (2.08mm <sup>2</sup> )		



UTS800/1200 UVT

## LOCKING SYSTEMS OVERVIEW

### PADLOCKING DEVICE

Padlocking device is available for UTE100 to UTS1200 circuit breakers. The locking device is designed to be easily attached to the circuit breaker. This device allows the handle to be locked in the “OFF” position. The locking device for the toggle handle can be installed in circuit breakers. Maximum three (3) padlocks with shackle diameters of 0.19~0.31 in. (5~8mm) may be used. (Padlocks are not supplied.)

DESCRIPTION	CIRCUIT BREAKERS	FUNCTION
PL0	UTE100	Lock in “OFF” position
PL2	UTS150/250	
PL3	UTS400/600	
PL5	UTS800/1200	

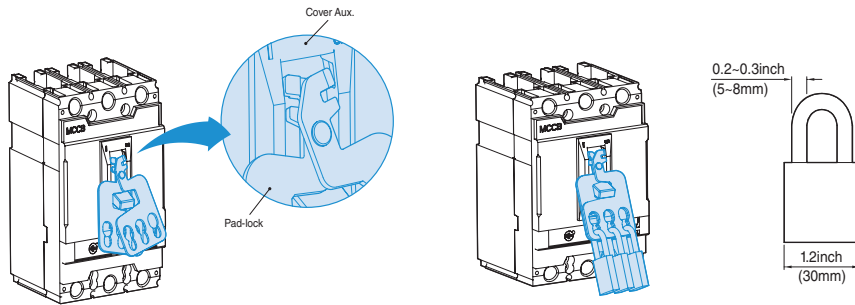

Pad Lock

### PLATE HANDLE LOCKING DEVICE

Fixed Plate Handle locking device is available for to UTE100 from UTS1200 circuit breakers. This device allows the handle to be locked in the “ON” and “OFF” position. The locking device for the toggle handle can be installed in 2-pole and 3-pole circuit breakers. Maximum three (3) padlocks with shackle diameters ranging from 0.19 to 0.31in (5~8mm) may be used. (Plate handle locks are not supplied)

DESCRIPTION	CIRCUIT BREAKERS	FUNCTION
PHL0	UTE100	Lock in “OFF” or “ON” position
PHL2	UTS150/250	
PHL3	UTS400/600	
PHL5	UTS800/1200	

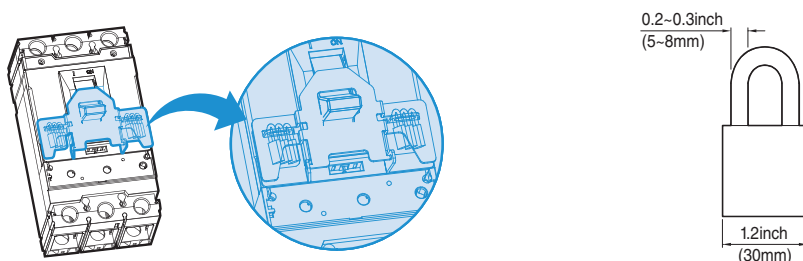

Plate Handle Lock

## INTERLOCKING SYSTEMS OVERVIEW

### MECHANICAL INTERLOCKING DEVICE

The mechanical interlock (MIT) can be applied on the front of two breakers mounted side by side, in either the 2-pole or 3-pole version and prevents simultaneous closing of the two breakers. Fixing is carried out directly on the cover of the breakers. The front interlocking plate allows installation of a padlock in order to fix the position. (Possibility of locking in the O-O position as well) This mechanical interlocking device is very useful and simple for consisting of manual source-changeover system.

DESCRIPTION	CIRCUIT BREAKERS	POLE
MIT03	UTE100	3
MIT23	UTS150/250	2 or 3
MIT33	UTS400/600	2 or 3
MIT53	UTS800/1200	3



Mechanical Interlock

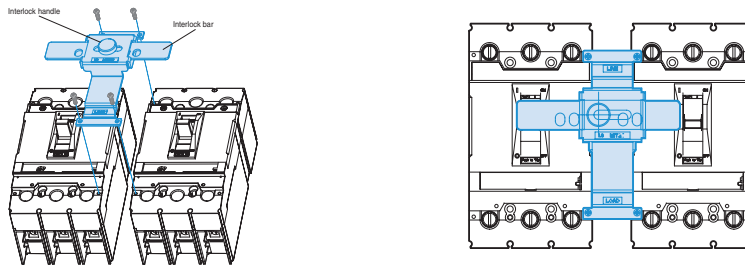

## ENCLOSURE DIMENSIONS OVERVIEW

The short circuit rating of an enclosed circuit breaker is equal to the rating of the circuit breaker installed, except as footnoted.

Circuit breakers are ordered and shipped separately for field installation

### ENCLOSURE DIMENSIONS

CIRCUIT BREAKER	AMPERAGE	ENCLOSURE DIMENSIONS (W X H X D) inch (mm)	
		80%	100%
UTE100 1P	15~100A	6.30 (160) X 17.3 (439.4) X 3.94 (100)	
UTE100	15~100A	8.27 (210) X 17.3 (439.4) X 4.0 (101.6)	
UTS150	40~150A	8.58 (218) X 18.11 (460) X 4.02 (102)	
UTS250	150~250A	12.13 (308) X 28.5 (724) X 5.35 (136)	
UTS400	250~400A	13.78 (350) X 40.16 (1020) X 5.98 (152)	13.78 (350) X 40.16 (1020) X 7.17 (182)
UTS600	500~600A	13.78 (350) X 40.16 (1020) X 5.98 (152)	14.17 (360) X 41.34 (1050) X 7.17 (182)
UTS800	400~800A	20.25 (514.4) X 51.9 (1318.3) X 7.75 (196.9)	
UTS1200	800~1200A	20.25 (514.4) X 51.9 (1318.3) X 7.75 (196.9)	23.0 (584.2) X 62.25 (1581.2) X 14.75 (374.7)

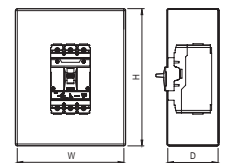

Enclosure Dimensions

## BUSBAR CONNECTIONS OVERVIEW

UTE100 and UTS250 frame circuit breakers may be equipped with captive nuts and screws for direct connection to bars.

Terminal plates are needed for replacement of lug connections with busbar connections. And to UTS400 from UTS1200 frame circuit breakers may be equipped without terminal plates.

### TERMINAL PLATE FOR BUSBAR CONNECTION OF UTE100, UTS150 AND UTS250 CIRCUIT BREAKERS

DESCRIPTION	CIRCUIT BREAKERS	TOOL	QTY PER KIT	TORQUE	
Terminal Plate,UTE100-3P	TP03	UTE100	+Driver	3	30.4 lb-in (3.43 N•m)
Terminal Plate,UTS150-3P	TP2a3	UTS150	+Driver	3	50 lb-in (5.64 N•m)
Terminal Plate,UTS250-3P	TP2b3	UTS250	Hex 1/4 inch	3	117.8 lb-in (13.3 N•m)

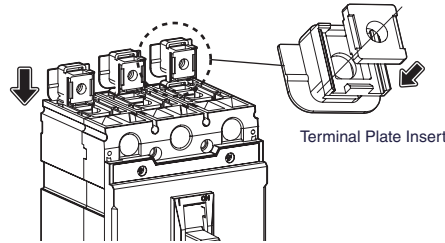
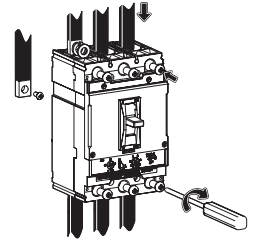

### BUSBAR DIMENSION OF TO UTE100 FROM UTS1200 CIRCUIT BREAKER

Dimensions: inch(mm)

CIRCUIT BREAKERS	A	B	C	D	E	F
UTE100	0.2(5.1)	0.08~0.28(2~7.2)	0.35(9)	0.32(8)	0.26(6.5)	-
UTS150	0.26 (6.5)	0.122~0.24 (3.1~6)	0.51~0.63 (13~16)	0.49 (12.5)	0.31 (8)	-
UTS250	0.33 (8.5)	0.122~0.31 (3.1~8)	0.51~0.79 (13~20)	0.98 (25)	0.31 (8)	-
UTS400	0.39 (10)	0.118~0.31 (3~8)	1.26 (32)	1.18 (30)	0.55 (14)	-
UTS600	0.39 (10)	0.118~0.47 (3~12)	1.26 (32)	1.18 (30)	0.55 (14)	-
UTS800	0.35 (9)	0.26~0.31 (6.5~8)	2.52 (64)	1.18 (30)	0.59 (15)	0.98 (25)
UTS1200	0.43 (11)	0.31~0.39 (8~10)	3.03 (77)	1.18 (30)	0.59 (15)	0.98 (25)

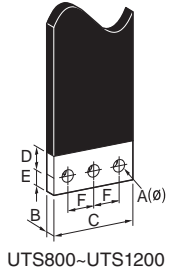
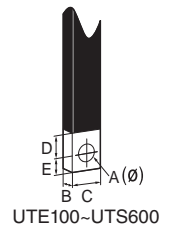

### CONTROL WIRE TERMINAL FOR MECHANICAL LUGS AND TERMINAL PLATE

Mechanical lugs may be equipped with a separate control wire terminal. The kit is available as a field installable kit. The adaptor is secured underneath the lug and has a tab extension suitable for attachment of a 1/4 inch slip-on connector.

Fully insulated type connectors must be used to prevent live parts from extending into the wiring gutter area.

DESCRIPTION	CIRCUIT BREAKERS	QTY PER KIT
Control wire terminal, CWT	UTE100	2
	Under 40A	
	Over 40A	
	UTS150	
	UTS250	
	UTS400	
UTS600		

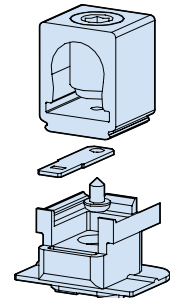

## BUSBAR CONNECTIONS

Fixed, front-connection busbars are equipped with terminals comprising captive screws for direct connection of bars. Other connection possibilities for bars include vertical-connection adapters for edgewise bars and spreaders to increase the pole pitch.

DESCRIPTION	CIRCUIT BREAKERS	POLE	QTY PER SET
SP02a	UTE100	2P	2
SP03a		3P	3
SP2a2a	UTS150	2P	2
SP2a3a		3P	3
SP2b2a	UTS250	2P	2
SP2b3a		3P	3
SP32a	UTS400	2P	2
SP33a	UTS600	3P	3
SP53a	UTS800 UTS1200		3
SP53e		3P	3
SP53v			3

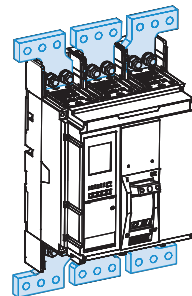

Busbar(a)

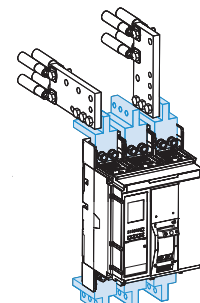

Extension Busbar(e)  
Vertical Busbars(v)

## INSULATION BARRIER

These barriers are insulated between the phases for increase insulation level. The barriers can be easily installed, even on breakers that are already mounted, by inserting them into the corresponding slots. They are incompatible with both the insulating terminal covers.

It is possible to mount the phase separating partitions between two side by side circuit breakers.

DESCRIPTION	CIRCUIT BREAKERS	POLE	QTY PER SET
B03	UTE100	3P	4
B23	UTS150 UTS250	3P	4
B33	UTS400 UTS600	3P	4
B53 BE53	UTS800 UTS1200	3P	2 2

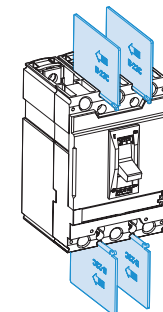

Standard Type

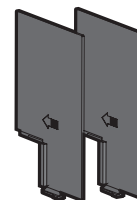

Standard Type(B53)

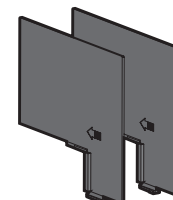

Extended Type(BE53)

# HANDLES

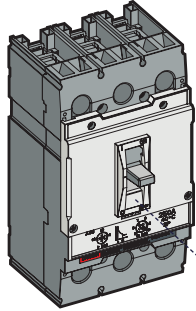

Molded Case Circuit Breaker  
Motor Circuit Protector  
Molded Case Switch

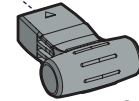

Aux. Handle

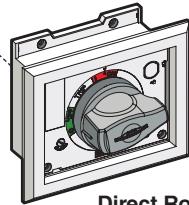

Direct Rotary Handle

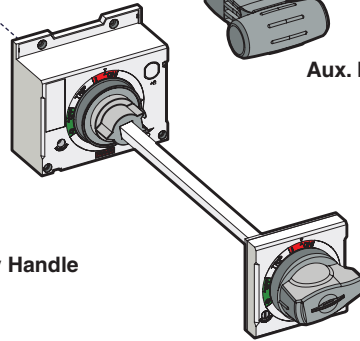

Extended Handle

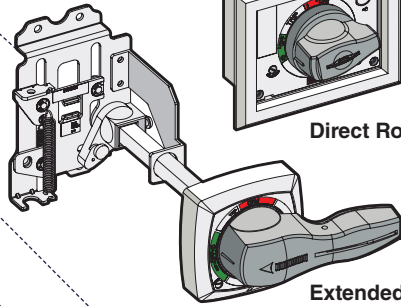

Extended Handle

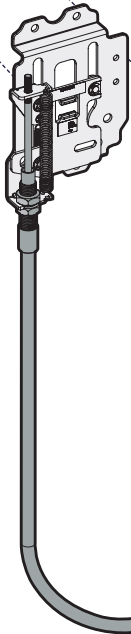

Flange Cable Handle

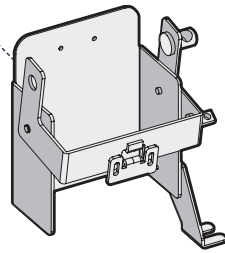
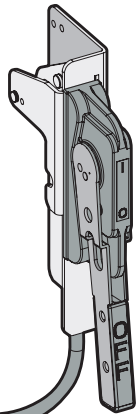

Operating Mechanism (VDM/COM)

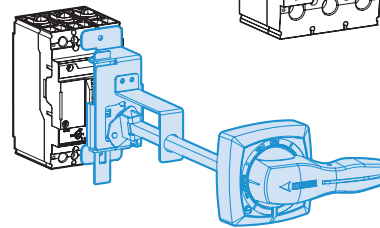
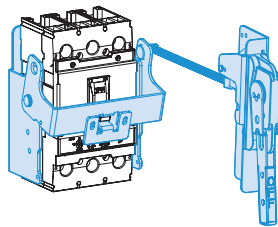
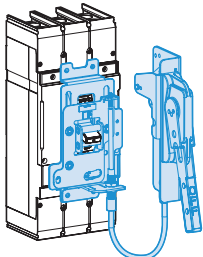
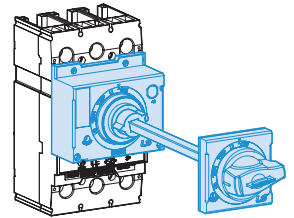
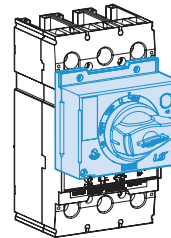

## HANDLE MECHANISMS OVERVIEW

All kinds of handles are suitable for field installation in LS molded case circuit breakers, molded case switches and motor circuit protectors. These are directly mounted rotary, door mounted and flange handles for installation of above noted products for 2 and 3 poles. In case of extended rotary handle, Base lower case assembly should be installed to circuit breaker, Handle should be mounted on panel door and they are interconnected by shaft. In case of flange mounting rotary handle, Base lower case assembly should be installed to circuit breaker, Handle should be mounted on panel door and they are connected by cable.

### CONSTRUCTION DETAIL:

#### Corrosion Protection:

All iron and steel parts are protected against corrosion by painting or equivalent means.

**Handle indication Making:** The following making are provided

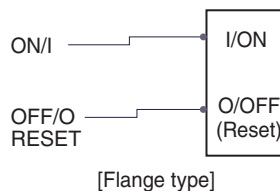
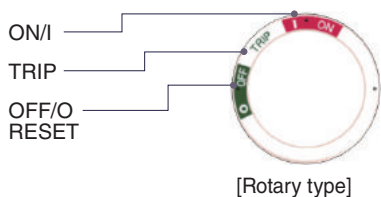

#### CAUTION Markings:

The following markings are provided:



## SELECTION FOR HANDLES

### • Catalog Numbering [Product Selection]

**EHU**

**0**

**12**

DESCRIPTION		MODEL SIZE PER CIRCUIT BREAKER FRAME		SHAFT & CABLE SIZE PER HANDLES	
<b>EHU</b>	Extended Hatndle (Type 1,12)	<b>0</b>	100AF (for all type)	<b>12</b>	12inch (Shaft)
<b>EHV</b>	Extended Handle (Type 3,3R,4)	<b>0C</b>	100AF (for all type & Compact base)	<b>16</b>	16inch (Shaft)
<b>EHX</b>	Extended Handle (Type 3,4,4X)	<b>2</b>	150/250 AF (for all type)	<b>24</b>	24inch (Shaft)
<b>FHU</b>	Flange Mounting Handle (Type 1, 12, 3, 3R, 4)	<b>3</b>	400/600 AF (for all type)	<b>36</b>	36inch (Cable)
<b>FHX</b>	Flange Mounting Handle (Type 4, 4X)	<b>5</b>	800/1200 AF (for all type)	<b>48</b>	48inch (Cable)
<b>REH</b>	Extended Rotary Handle (Type 1)	<b>S</b>	Standard Type (for Flange handle)	<b>60</b>	60inch (Cable)
<b>DH</b>	Direct Rotary Handle(Type 1)	<b>L</b>	Long type (for Flange handle)	<b>72</b>	72inch (Cable)
<b>DHK</b>	Direct Rotary Handle Keylock type(Type 1)			<b>84</b>	84inch (Cable)
<b>VDM</b>	Variable Depth Mechanism			<b>128</b>	128inch (Cable)
<b>COM</b>	Cable Operating Mechanism			<b>BLANK</b>	No type



## APPLICATION FOR HANDLES

Handle mechanisms are used to operate molded case circuit breakers, molded case switches and motor circuit protectors. They are available in three basic configurations-Directly mounted, Door mounted and Flange mounted for providing safe, easy installation and dependable operation.

OPERATION HANDLE TYPE NAME	APPLIED TO UL489 MCCB/MCS	
	CIRCUIT BREAKER & SWITCH	TYPE
EHU0-12-24 EHV0-12-24 EHX0-12-24 EHU0C-12-24 EHV0C-12-24 EHX0C-12-24 REH0-12-24 REH0C-12-24 DH0 VDM0, FHU-S VDM0, FHX-S COM0, FHU-S COM0, FHX-S	MCCB	UTE100 (100AF, 2 or 3Pole)
EHU2-12-24 EHV2-12-24 EHX2-12-24 FHU2-36-72 FHX2-36-72 REH2-12-24 DH2 DHK2 VDM2, FHU-S VDM2, FHX-S COM2, FHU-S COM2, FHX-S	MCCB MCP      MCS	UTS150 (150AF, 2 or 3 Pole)   UTS250 (250AF, 2 or 3 Pole)   UTS150 (150AF, 3 Pole)  UTS250 (250AF, 3 Pole)
EHU3-12-24 EHV3-12-24 EHX3-12-24 FHU3-36-72 FHX3-36-72 REH3-12-24 DH3 DHK3 VDM3, FHU-L VDM3, FHX-L COM3, FHU-L COM3, FHX-L	MCCB MCP      MCS	UTS400 (400AF, 2 or 3 Pole)   UTS600 (600AF, 2 or 3 Pole)   UTS400 (400AF, 3 Pole)  UTS600 (600AF, 3 Pole)
EHU5-12-24 EHV5-12-24 EHX5-12-24 FHU5-60-128 FHX5-60-128 REH5-12-24 DH5 DHK5 VDM5, FHU-L VDM5, FHX-L COM5, FHU-L COM5, FHX-L	MCCB MCP      MCS	UTS800 (800AF, 3 Pole)   UTS1200 (1200AF, 3 Pole)   UTS800 (800AF, 3 Pole)  UTS1200 (1200AF, 3 Pole)

**MCCB:** Molded Case Circuit Breaker  
**MCP:** Motor Circuit Protector  
**MCS:** Molded Case Switch

## ROTARY OPERATING HANDLES

### DIRECTLY MOUNTED ROTARY OPERATING HANDLE

The directly mounted rotary operating handle replaces the circuit breaker front accessory cover. When using UTE100, front cover does not have to be replaced.

The direct rotary handle maintains:

- Suitability for isolation
- Indication of three positions: I (ON), Tripped and O (OFF)
- Access to the “push-to-trip” button
- Visibility of, and access to, trip unit settings
- The circuit breaker may be locked in the ON/OFF position by using padlock (not supplied)

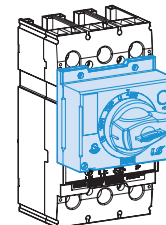

Directly Mounted Rotary Operating Handle

### MODELS

- Standard with dark gray handle
- Field installable (secured by screws)

UTE 100	UTS150/250	UTS 400/600	UTS 800/1200
DH-0	DH-2	DH-3	DH-5

- Field installable with Key lock (secured by screws)

UTS150/250	UTS400/600	UTS800/1200
DHK-2	DHK-3	DHK-5

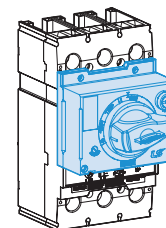

Directly Mounted Rotary Operating Handle with key lock.

Accessories transform the standard direct rotary handle for the following situations:

- Opening of door prevented when circuit breaker is on
- Closing of circuit breaker inhibited when door is open

### STANDARDS

The directly-mounted rotary operating handle is UL Listed under file E223241  
Degree of protection NEMA Type 1

## ROTARY OPERATING HANDLES

### EXTENDED (DOOR-MOUNTED) ROTARY OPERATING HANDLE

The extended rotary operating handle replaces the front accessory cover of the circuit breaker (secured by screws). When using UTE100, front cover does not have to be replaced.

The extended rotary operating handle consists of:

- A handle assembly with front plate on the door that is always secured in the same position, whether the circuit breaker is installed vertically or horizontally
- An adjustable extension shaft
- The handle mechanism can be used in NEMA Type 1 enclosure applications

The extended rotary operating handle makes it possible to operate circuit breakers installed in enclosure from the front.

- Suitability for isolation
- Indication of the three positions OFF (O), ON (I) and tripped
- Visibility of and access to trip unit settings when the door is open
- Degree of protection: NEMA Type 1
- Defeatable interlock prevents opening of door when circuit breaker is on

The circuit breaker may be locked in the off position by using padlock, padlock shackle diameter 0.2~0.3 inch(5~8mm); padlocks are not supplied; locking prevents opening of the enclosure door

#### MODELS

- Standard with dark gray handle
- Field installable (secured by screws)

UTE 100		UTS150/250	UTS 400/600	UTS 800/1200
REH-0	REH-0C	REH-2	REH-3	REH-5

The shaft length is the distance between the back of the circuit breaker and the door:

- Minimum mounting depth is 5.51 in. (140 mm) in UTE100
- Minimum shaft length is 12 in. (305 mm) with standard shaft
- Maximum shaft length is 24 in. (600 mm) with long shaft
- Extended shaft length must be adjusted

#### STANDARDS

The door-mounted rotary operating handle is UL Listed under file E223241  
Degree of protection NEMA Type 1

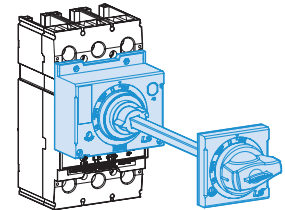

Door-Mounted Rotary Operating Handle (REH-0, 2, 3, 5)

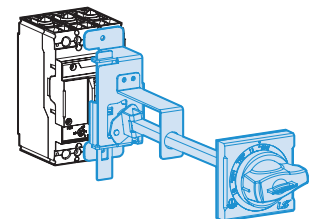

Door-Mounted Rotary Operating Handle (REH-0C)

## NEMA DOOR-MOUNTED ROTARY OPERATING HANDLE

The extended rotary operating handle consists of:

- A mounting plate that provides a rotary actuator for a standard toggle circuit breaker
- Handle assemblies available for NEMA Type 1, 12, 3, 3R, 4, 4X
- Available in standard or long (12~24 in.) handle assemblies

The door mounted operating handle makes it possible to operate circuit breakers installed in enclosure from the front.

- Indication of three positions: I (ON), Tripped and O (OFF) : NEMA Type 1, 12
- Provides ON (I) and OFF (O) indication : NEMA Type 3, 3R, 4, 4X
- The circuit breaker may be locked in the ON/OFF position

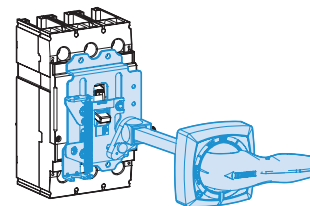

Door Mounted rotary operating handle  
[EHU, V, X-0, 2, 3, 5]

### MODELS

- Standard with dark gray handle(NEMA Type 1, 12)
- Out door with black handle(NEMA Type 3, 3R, 4, 4X)
- Field installable (secured by screws)

UTE100		UTS150/250	UTS 400/600	UTS 800/1200
EHU-0	EHU-0C	EHU-2	EHU-3	EHU-5
EHV-0	EHV-0C	EHV-2	EHV-3	EHV-5
EHX-0	EHX-0C	EHX-2	EHX-3	EHX-5

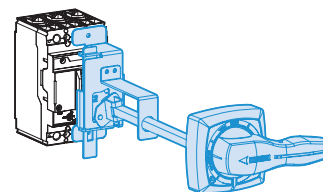

Door Mounted rotary operating handle  
[EHU, V, X-0C]

The shaft length is the distance between the back of the circuit breaker and door:

- Minimum mounting depth is 5.51 in. (140mm) in UTE 100
- Minimum shaft length is 12 in. (305mm) with long shaft
- Minimum shaft length is 24 in. (600mm) with long shaft
- Extended shaft length must be adjusted

### STANDARDS

The door-mounted rotary operating handle is UL Listed under file E223241  
Degree of protection NEMA Type 1, 12, 3, 3R, 4, 4X

## FLANGE HANDLE

### FLANGE HANDLE WITH SLIDING OPERATING MECHANISM

Flange handle with sliding operating mechanism is for use with cable

The cable operator maintains:

- Suitability for isolation
- Indication of two positions: O (OFF) and I (ON)
- The circuit breaker may be locked in the off position by one to three padlocks
- Door can be locked closed due to interlocking features of the handle operator
- Operating Mechanism has one type
  - Cable operating type with sliding mechanism

Handle is mounted on flange of enclosure using specified mounting dimensions while circuit breaker and operating mechanism are mounted to inside of enclosure using screws

- Handles are available in FHU (NEMA Type 1, 12, 3, 3R, 4) and FHX (NEMA Type 4, 4x)
- All circuit breaker operating mechanisms are suitable for right-hand flange mounting on the job.

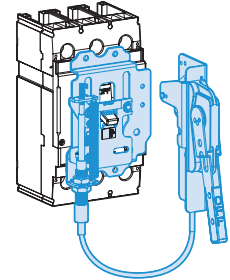

Flange handle with sliding operating mechanism and Cable [FHU-2, FHX-2]

### MODELS

- Standard with painted handle (NEMA Type 1, 12, 3, 3R, 4)
- Out door with nickel plating handle (NEMA Type 4, 4X)
- Field installable (secured by screws)

UTE100	UTS150/250	UTS 400/600	UTS 800/1200
-	FHU-2 FHX-2	FHU-3 FHX-3	FHU5 FHX5

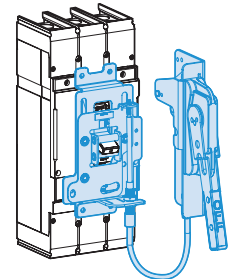

Flange handle with sliding operating mechanism and Cable [FHU-3, FHX-3]

FHU : Standard type handle (NEMA Type1, 12, 3, 3R, 4) with sliding mechanism and without cable

FHX : Outdoor type handle (NEMA Type 4, 4X) with sliding mechanism and without cable

Cable : Only cable

- Cable lengths available in 36,48,60,72 inch (UTS150~UTS600), 60,84,128 inch (UTS800~UTS1200) lengths to accommodate a variety of mounting locations

### STANDARDS

Flange cable operating handle is UL Listed under file E223241

NEMA Type 1, 12, 3, 3R, 4, 4X

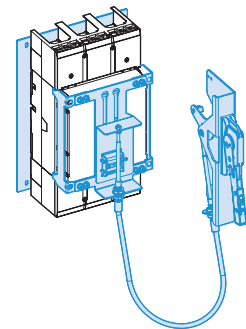

[FHU-5, FHX-5]

## FLANGE-MOUNTED CABLE OPERATING MECHANISM

Flange-mounted handle cable operating mechanism is for use with FH or COM Type handle operators especially designed for tall, deep enclosures where placement flexibility is required.

The cable operator maintains:

- Suitability for isolation
- Indication of two positions: O (OFF) and I (ON)
- The circuit breaker may be locked in the off position by one to three padlocks
- Door can be locked closed due to interlocking features of the handle operator
- Operating Mechanism has one type
  - COM : Cable operating type with handle operator
- Handle operators (FHU, FHX)

Handle is mounted on flange of enclosure using specified mounting dimensions while circuit breaker and operating mechanism are mounted to inside of enclosure using screws

- Handles are available in COM and FHU NEMA Type 1, 12, 3, 3R, 4 and FHX NEMA Type 4, 4x
- All circuit breaker operating mechanisms are suitable for right-hand flange mounting on the job.
- COM frame operating mechanism does not include cable.

### MODELS

- Standard with painted handle(NEMA Type 1, 12, 3, 3R, 4): FHU
- Out door with nickel plating handle(NEMA Type 4, 4X): FHX
- Field installable (secured by screws)

UTE100	UTS150/250	UTS400/600	UTS800/1200
FHU-S	FHU-S	FHU-L	FHU-L
FHX-S	FHX-S	FHX-L	FHX-L
COM-0	COM-2	COM-3	COM-5

FHU-S, FHX-S : Standard type handle with operating mechanism  
 FHU-L, FHX-L : Long type handle with operating mechanism  
 COM : Cable operating mechanism with handle and without cable  
 Cable : only cable

### CABLE TYPE

CABLE LENGTHS [inch]	UTE100 UTS150 UTS250	UTS400 UTS600	UTS800 UTS1200
36	FH2-36	FH3-36	-
48	FH2-48	FH3-48	-
60	FH2-60	FH3-60	FH5-60
72	FH2-72	FH3-72	-
84	-	-	FH5-84
128	-	-	FH5-128

### STANDARDS

Flange cable operating handle is UL Listed under file E223241  
 NEMA Type 1, 12, 3, 3R, 4, 4X

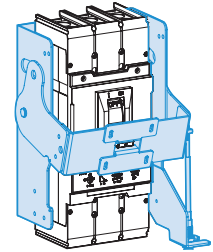

Cable Operating Mechanism without Handle and cable



Flange Handle [FHU, X-S, L]

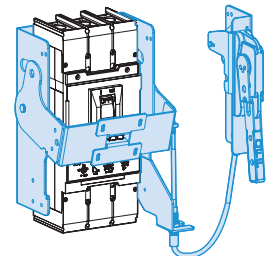

Handle with cable and Cable operating mechanism [COM-0, 2, 3, 5]

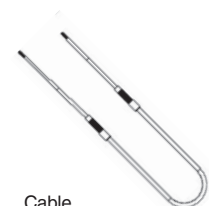

Cable [FH2, 3, 5-36~128]

# FLANGE HANDLE

## FLANGE-MOUNTED VARIABLE DEPTH OPERATING MECHANISM

Designed for installation in custom built control enclosures where main or branch circuit protective devices are required.

The variable depth operator maintains:

- Suitability for isolation
- Indication of two positions: O (OFF) and I (ON)
- The circuit breaker may be locked in the off position by one to three padlocks
- Door can be locked closed due to interlocking features of the handle operator
- Operating Mechanism has one type
  - VDM : Variable depth type with handle operator
- Handle operators(FHU, FHX)
- Threaded-rod has only one type

Handle is mounted on flange of enclosure using specified mounting dimensions while circuit breaker and

operating mechanism are mounted to inside of enclosure using screws

- Handles are available in VDM and FHU NEMA Type 1,12, 3, 3R, 4 and FHX NEMA Type 4, 4x
- All circuit breaker operating mechanisms are suitable for right-hand flange mounting on the job.
- VDM frame operating mechanism includes handle operator.

### MODELS

- Standard with painted handle(NEMA Type 1,12,3,3R,4)
- Out door with nickel plating handle(NEMA Type 4, 4X)
- Field installable(secured by screws)

UTE100	UTS150/250	UTS400/600	UTS800/1200
FHU-S	FHU- S	FHU-L	FHU-L
FHX-S	FHX- S	FHX-L	FHX-L
VDM-0	VDM-2	VDM-3	VDM-5

FHU-S, FHX-S : Standard type handle with operating mechanism

FHU-L, FHX-L : Long type handle with operating mechanism

VDM : Variable depth operating mechanism with threaded-rod and handle.

The variable mounting depth length is the distance between the back of the circuit breaker and the door:

- VDM frame variable mounting depth range: 8.0~21.26 in (203-540 mm).
- Threaded-rod length : 16 in. (406 mm)

### STANDARDS

Flange variable depth operating handle is UL Listed under file E223241

NEMA Type 1, 12, 3, 3R, 4, 4X

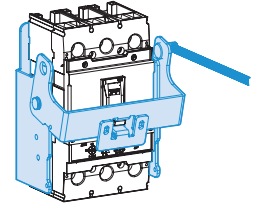

Variable-Depth operating Mechanism with Threaded-rod

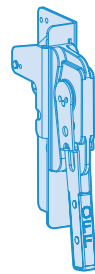

Flange Handle [FHU, X-S, L]

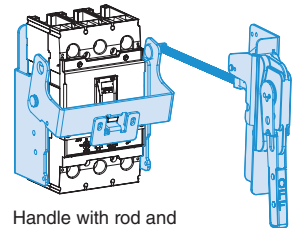

Handle with rod and Variable-Depth operating Mechanism [VDM-0, 2, 3, 5]

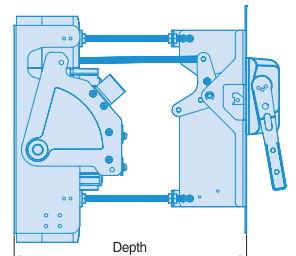

Variable mounting depth range



## REMOTE OPERATION

### MOTOR OPERATOR

Motor operators can be operated manually. The motor drives a mechanism which switches UTS toggle handle to the “ON” and “OFF/RESET” positions.

- The manual actuator handle is located on the front of the cover.
- Manual or Automatic operation can be selected.
- Applicable to 2, 3pole breakers.
- Door can be locked closed due to interlocking features of the handle operator
- Operating Mechanism has one type
  - Cable operating type with sliding mechanism

The motor operator is an essential device for constructing a remote operated automatic source-changeover system to ensure a continuous supply of electrical power at following certain installations:

- Commercial sector: Hospital, Tall building, Bank, Insurance companies, Shopping centers
- Industry: Ships, Assembly lines at plant, Military sites, Port and Railway installation



MOP2U-L



MOP3U-L

MCCB	Type	Control voltage (V)	Actuation current (A)	Response time (ms)		Consumption (W)	Mechanical service life (operations)	No. of operations per hour	Remarks
				Closing	Opening				
UTS150, 250	MOP2U	DC 24V	≤2.5A	350	230	14	25,000	120	Lock function
	MOP2U-L	AC 110V/DC 110V	(DC 24V)						
UTS400, 600	MOP3U	DC 24V	≤2.5A	500	350	35	20,000	60	Lock function
	MOP3U-L	AC 110V/DC 110V	(DC 24V)						
		AC 230V/DC 220V	≤0.5A (AC)						

### WIRING CONNECTION

#### Standard connection

Circuit breaker On and Off controlled by remote operation and manual operation

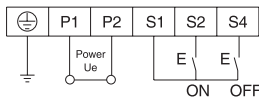

#### Connection with alarm switch (AL)

- 1) The below connection diagram is the method of using a alarm switch (AL) without shunt or undervoltage trip.
- 2) After clearing the fault surely, manual reset is mandatory in case of tripping due to an electrical fault.

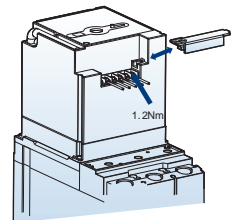
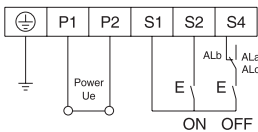

### MANUAL OPERATION

- 1) Insert the manual handle into the slot of Motor Operator surface and rotate it clockwise.
- 2) It must be rotated just 180° clockwise for safe operation of micro switch in the motor operator.
- 3) Return the manual handle after the manual operation
- 4) Turn the slide switch back to the position of AUTO.

**CAUTION:** When the circuit breaker is tripped by trip button in the OFF status, it is impossible to operate motor operator automatically. It must be reset by manual operation.

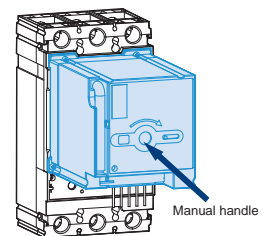

## REMOTE OPERATION

### AUTOMATIC OPERATION

- 1) Set the slide switch to AUTO, then internal power is closed automatically.
- 2) Operating frequency should be less than these below regulated values.  
 UTS150N/H/L , UTS250N/H/L: 120 operations per hour  
 UTS400N/H/L, UTS600N/H/L: 60 operations per hour
- 3) Use the ON/OFF switch in the range of regulated values.
- 4) It may interfere near communication equipments because of internal switching power supply.  
 It's recommended that a noise filter be installed to power supply.
- 5) Please do not input ON/OFF signals at the same time during the automatic operation.
- 6) If the circuit breaker has a UVT attached inside, charge a UVT on the rated voltage before performing MOTOR OPERATOR.

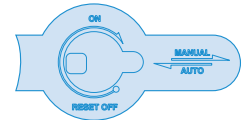

[UTS150, 250]

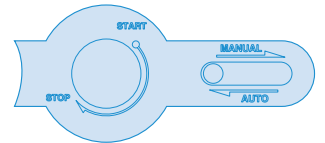

[UTS400, 630]

### MOTOR OPERATOR

#### Feature

- ① On position indication (Red color)
- ② Trip position indication (White color)
- ③ Off position indication (Green color)
- ④ Button for push to trip  
(available for only for UTS400AF and UTS600AF)
- ⑤ On/Off/Reset selection lever
- ⑥ Manual/Auto selection lever

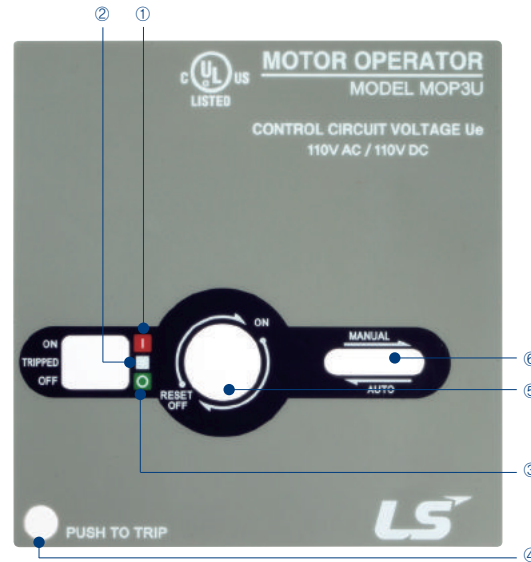

#### UTS150, 250 .... MOP2U



#### UTS400, 630 .... MOP3U

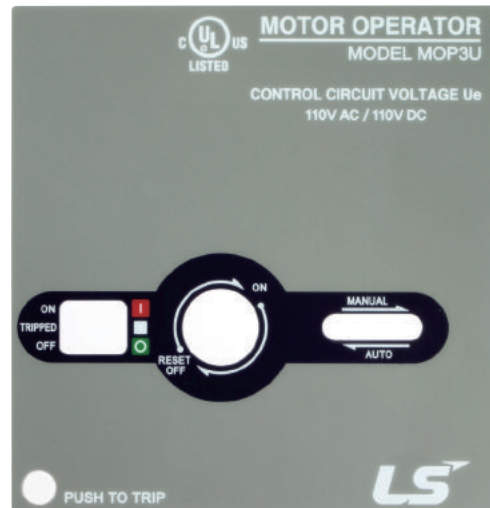

## RESIDUAL CURRENT PROTECTION

### RCD(RESIDUAL CURRENT DEVICE)

The UL Susol circuit breaker UTS250 can offer protection against earth leakage currents by using an add-on residual current device(RCD). RCD unit is mounted directly below the circuit breaker without the use of any secondary wiring or connections. It directly actuates the trip unit(FTU, FMU or ATU)

Addition of the RTU23U does not alter circuit-breaker characteristics.

- RTU23U guarantees protection of people against earth leakage currents.
- RTU23U has numerous current(From 0.03 to 10A) and time delay(From instantaneous to 0.6s) settings.
- RTU23U has test button for electrical and mechanical operation of the device.
- RTU23U has delectric plug for delectric test without damaging its electronic components.
- RTU23U has indicate button for tripping due to an earth leakage current.
- RTU23U is self-supplied internally by the distribution-system voltage.
- RTU23U may be equipped with a fault alarm switch(FAL) to remotely indicate earth leakage tripping.



MCCB	RCD TYPE	RATED OPERATING VOLTAGE (V)	SENSITIVITY (A)	INTENTIONAL DELAY (MS)
UTS250 Bolt-On Type	RTU23U	AC240~480V / AC480~600V	0.03-0.3-1-3-10	0-60-150-300-600
UTS250 Lug Type	RTU23U, L			

\* RTU23U can be only applied to FTU/FMU/ATU Trip Unit.

### CONFIGURATION

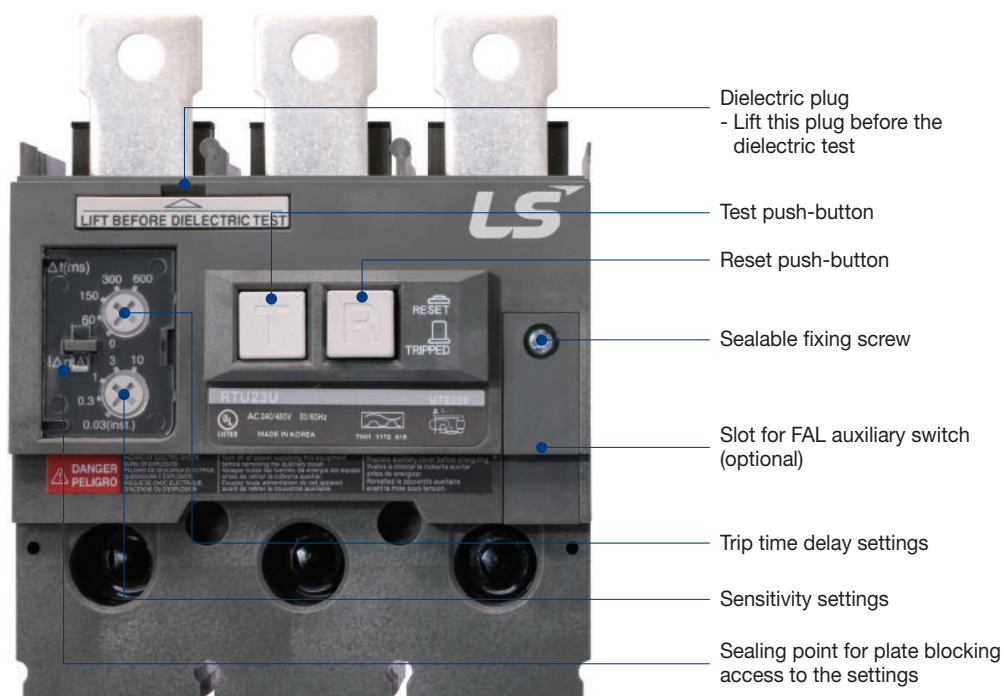

※ If the sensitivity is set to 30 mA, there is no time delay.  
Whatever the time-delay setting

## CHARACTERISTICS CURVES

UTE100	113 page
UTS150	115 page
UTS250	120 page
UTS400	124 page
UTS600	128 page
UTS150/250 (ETS23), UTS400/600 (ETS33)	132 page
UTS400/600 (ETM33)	134 page
UTS800	138 page
UTS1200	138 page

### LET-THROUGH ENERGY $I^2t$ AND PEAK LET-THROUGH CURRENT $I_p$

UTE100	144 page
UTS150	145 page
UTS250	146 page
UTS400	147 page
UTS600	148 page
UTS800	149 page
UTS1200	150 page

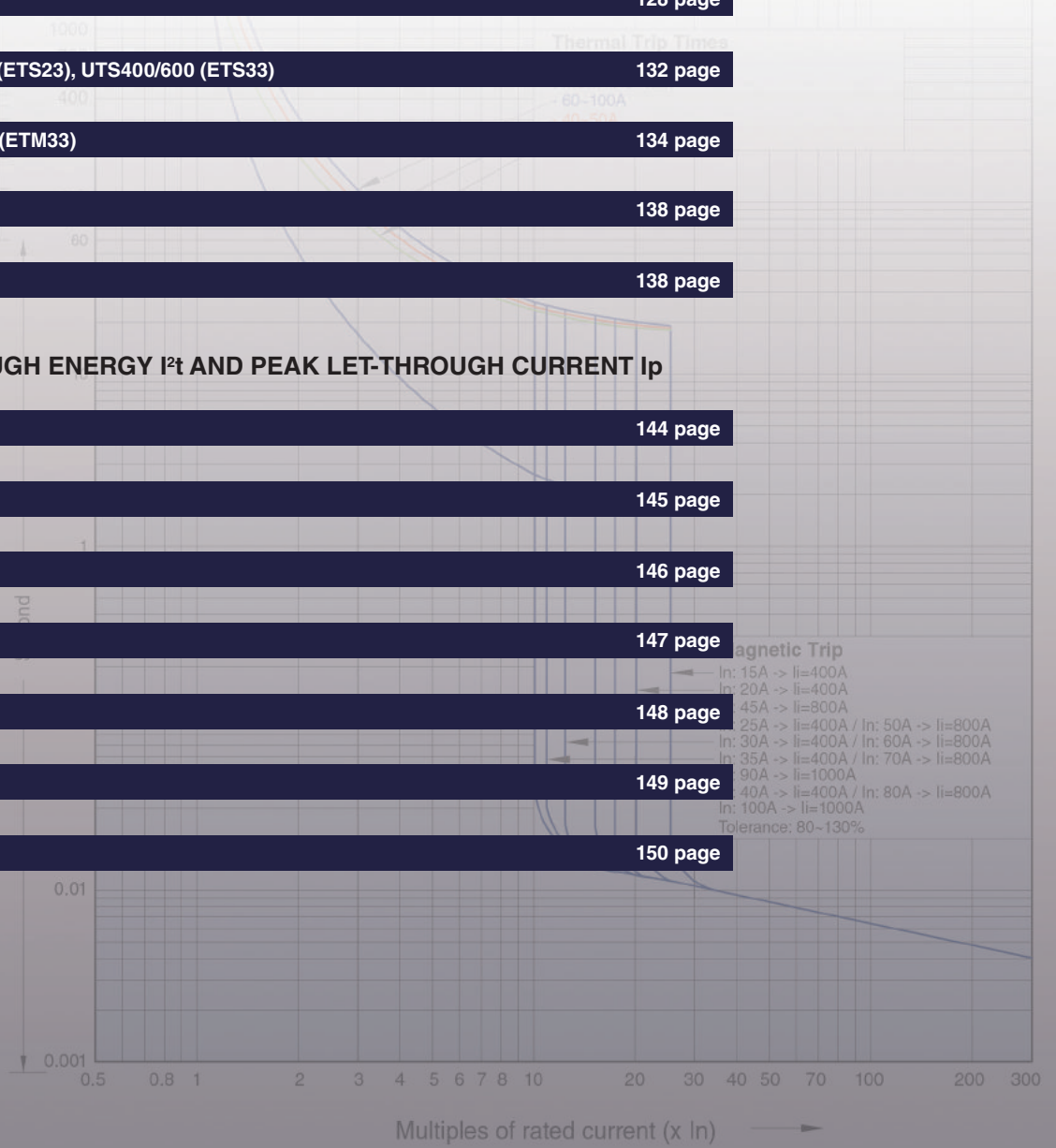

## UTE100 CHARACTERISTIC

This curve is to be used for application and coordination purposes only.  
All time/current characteristic curve data is based on 40°C ambient cold start.

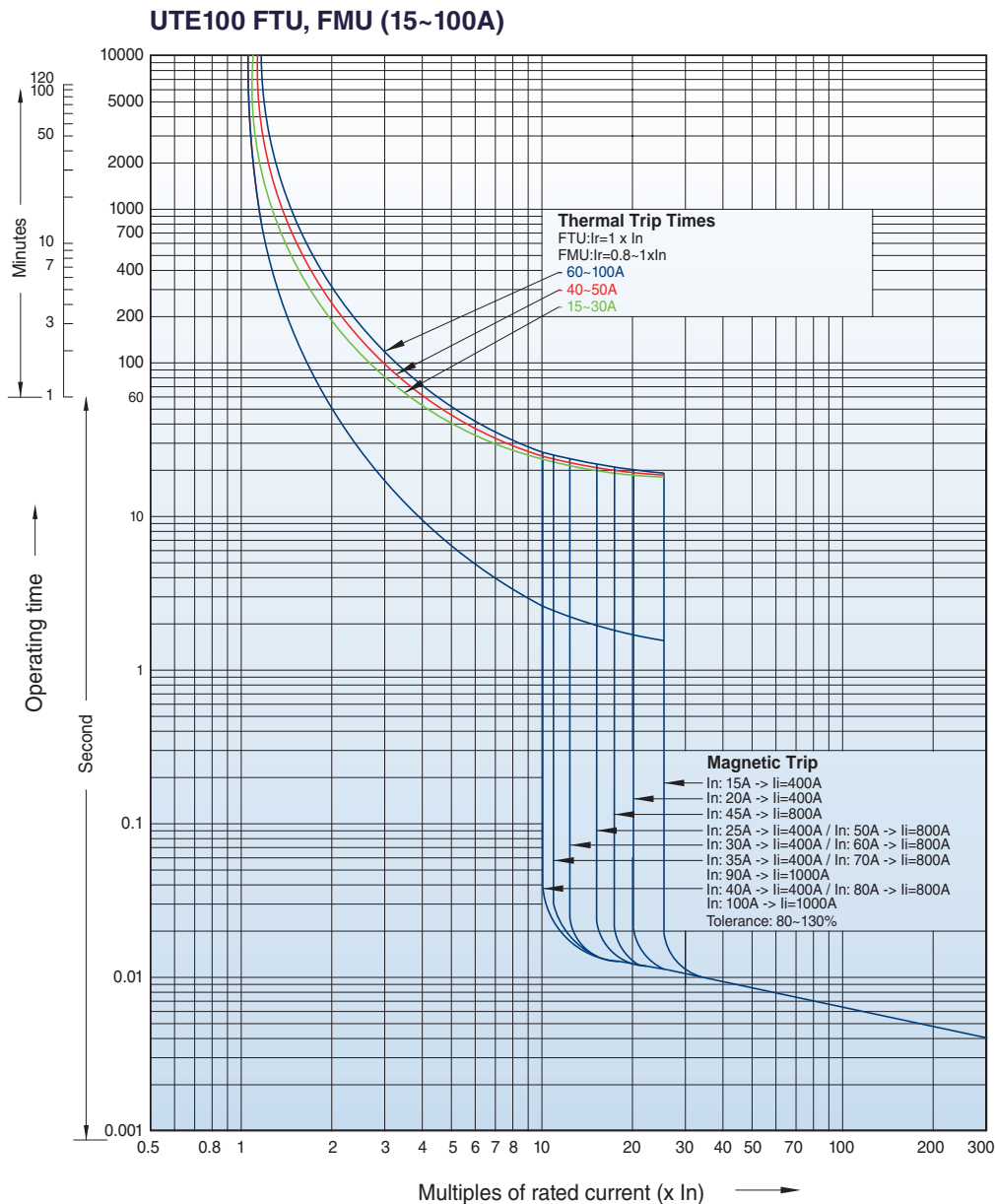

RATING UTE100	FTU	
	1P/2P/3P	MAG TRIP (80%~130%)
15	○	
20	○	
25	○	400A
30	○	
35	○	
40	○	
45	○	
50	○	
60	○	800A
70	○	
80	○	
90	○	1000A
100	○	

RATING UTE100	FMU		
	3P	RATING RANGE	MAG TRIP (80%~130%)
25	○	20~25A	
40	○	32~40A	400A
60	○	48~60A	
80	○	64~80A	800A
100	○	80~100A	1000A

## UTE100 CHARACTERISTIC

This curve is to be used for application and coordination purposes only.  
All time/current characteristic curve data is based on 40°C ambient cold start.

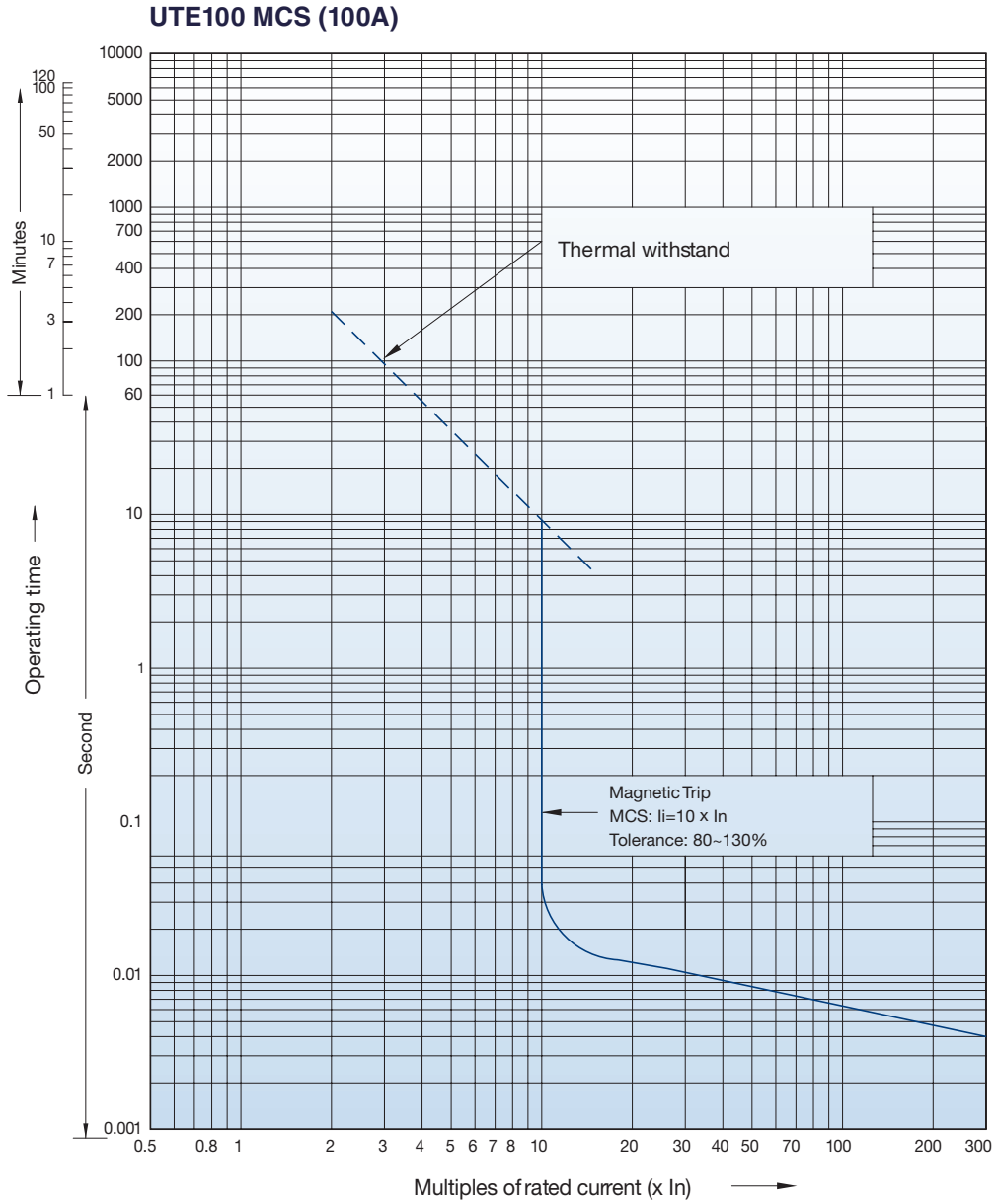

RATING	MCS (2P/3P)
UTE100	MAG TRIP (80%~130%) (10 x In)
100	1000A

## UTS150 CHARACTERISTIC

This curve is to be used for application and coordination purposes only.  
All time/current characteristic curve data is based on 40°C ambient cold start.

UTS150 FTU, FMU (40~150A)

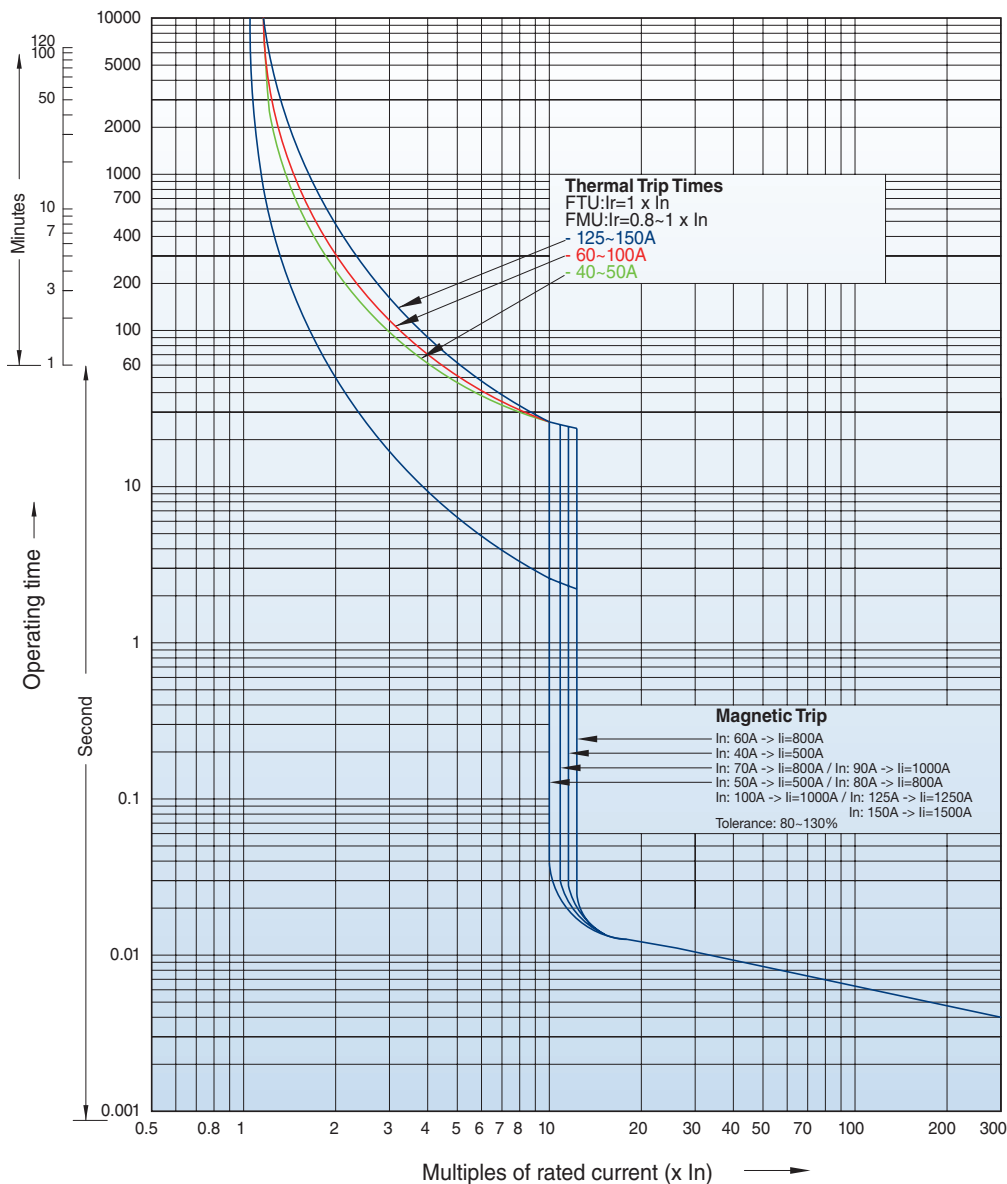

RATING UTS150	FTU	
	2P/3P	MAG TRIP (80%~130%)
40	○	500A
50	○	
60	○	
70	○	800A
80	○	
90	○	
100	○	1000A
125	○	1250A
150	○	1500A

RATING UTS150	FMU		
	2P/3P	RATING RANGE (0.8~1 x In)	MAG TRIP (80%~130%)
40	○	32~40A	500A
60	○	48~60A	800A
80	○	64~80A	800A
100	○	80~100A	1000A
125	○	100~125A	1250A
150	○	120~150A	1500A



## UTS150 CHARACTERISTIC

This curve is to be used for application and coordination purposes only.  
All time/current characteristic curve data is based on 40°C ambient cold start.

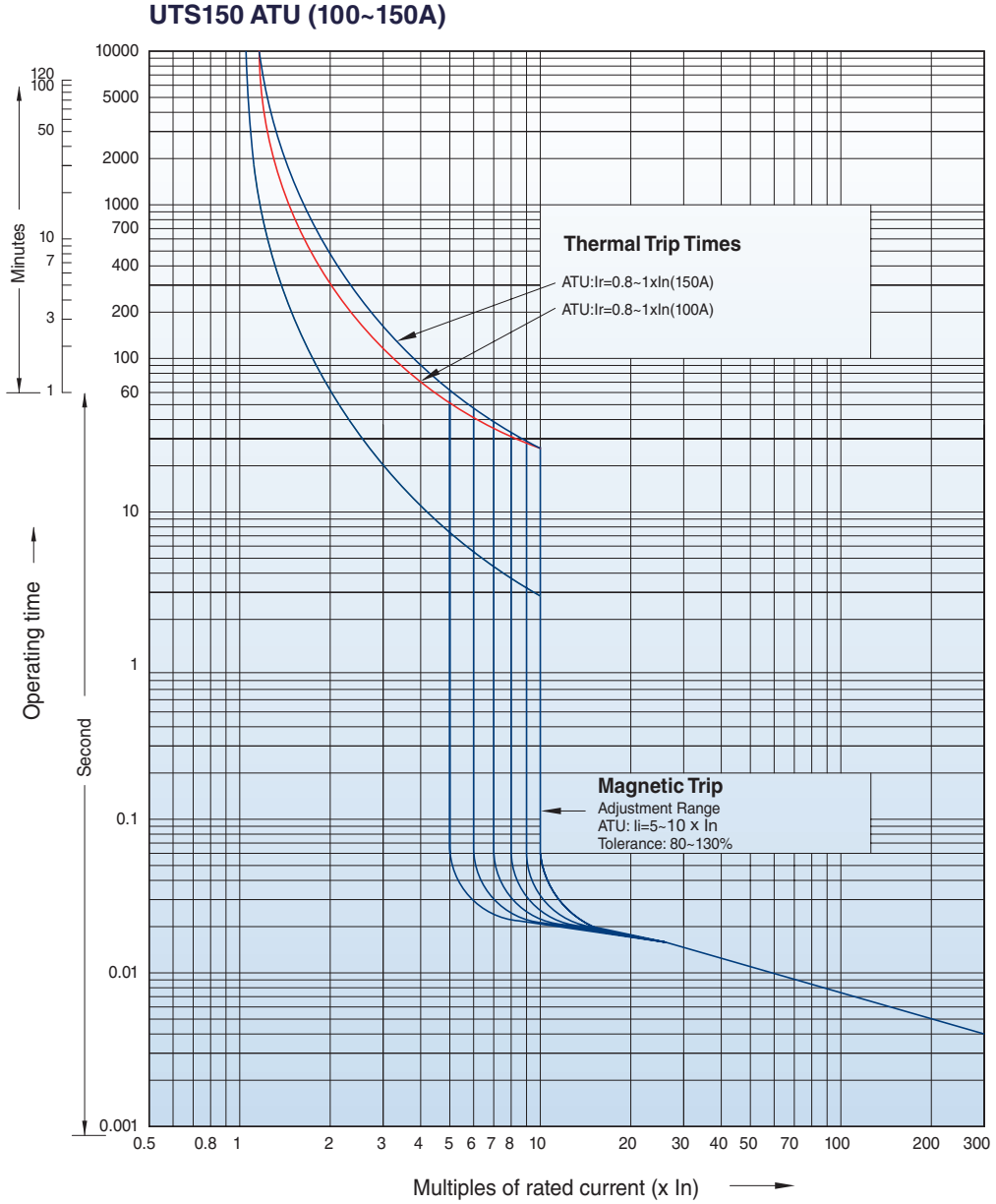

RATING UTS150	ATU		
	2P/3P	RATING RANGE (0.8~1 x In)	MAG TRIP (80%~130%) (5~10 x In)
100	○	80~100A	500~1000A
125	○	100~125A	625~1250A
150	○	120~150A	750~1500A

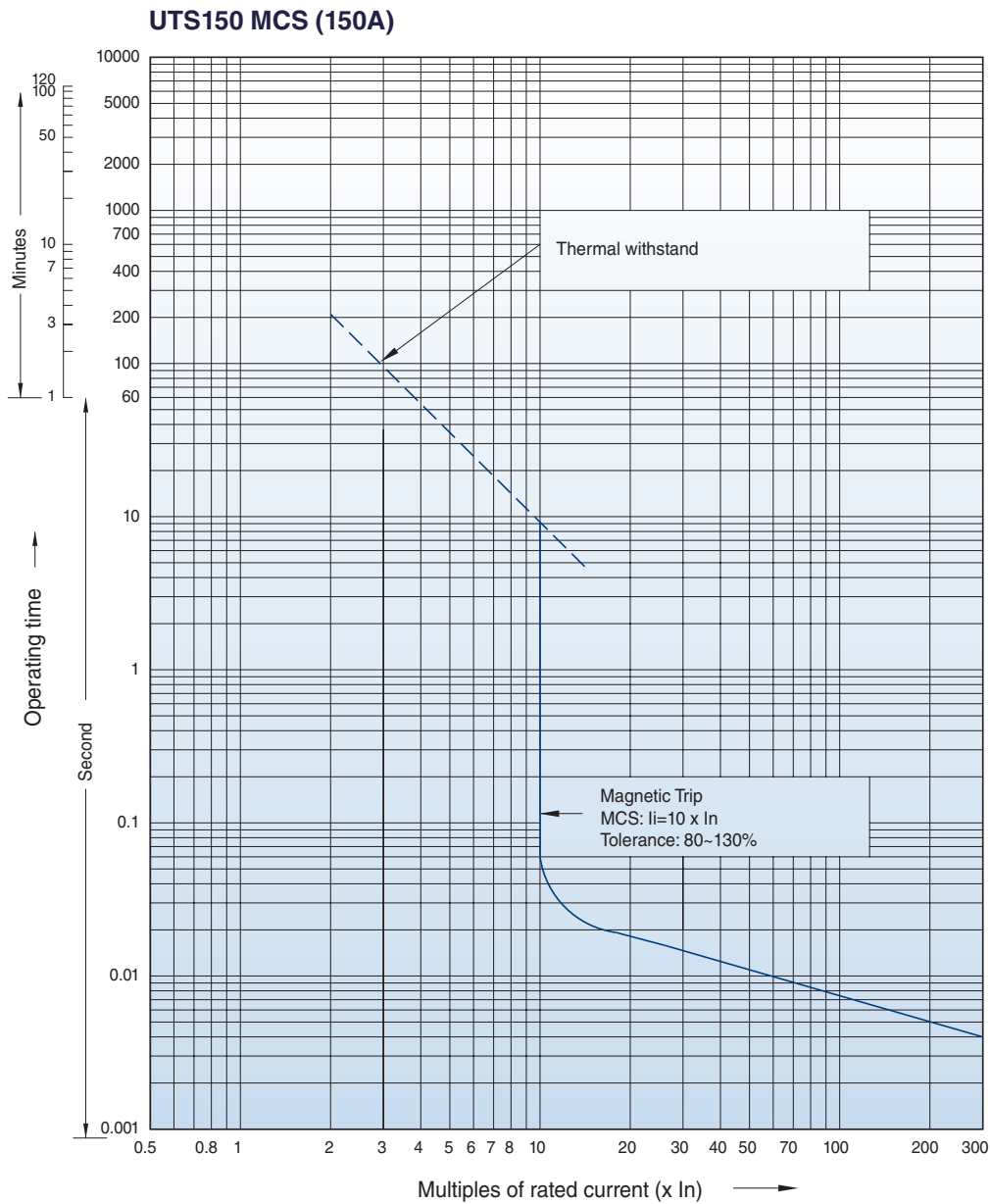

RATING	MCS (2P/3P)
	MAG TRIP (80%~130%) (10 x $I_n$ )
UTS150	1500A

## UTS150 CHARACTERISTIC

This curve is to be used for application and coordination purposes only.  
All time/current characteristic curve data is based on 40°C ambient cold start.

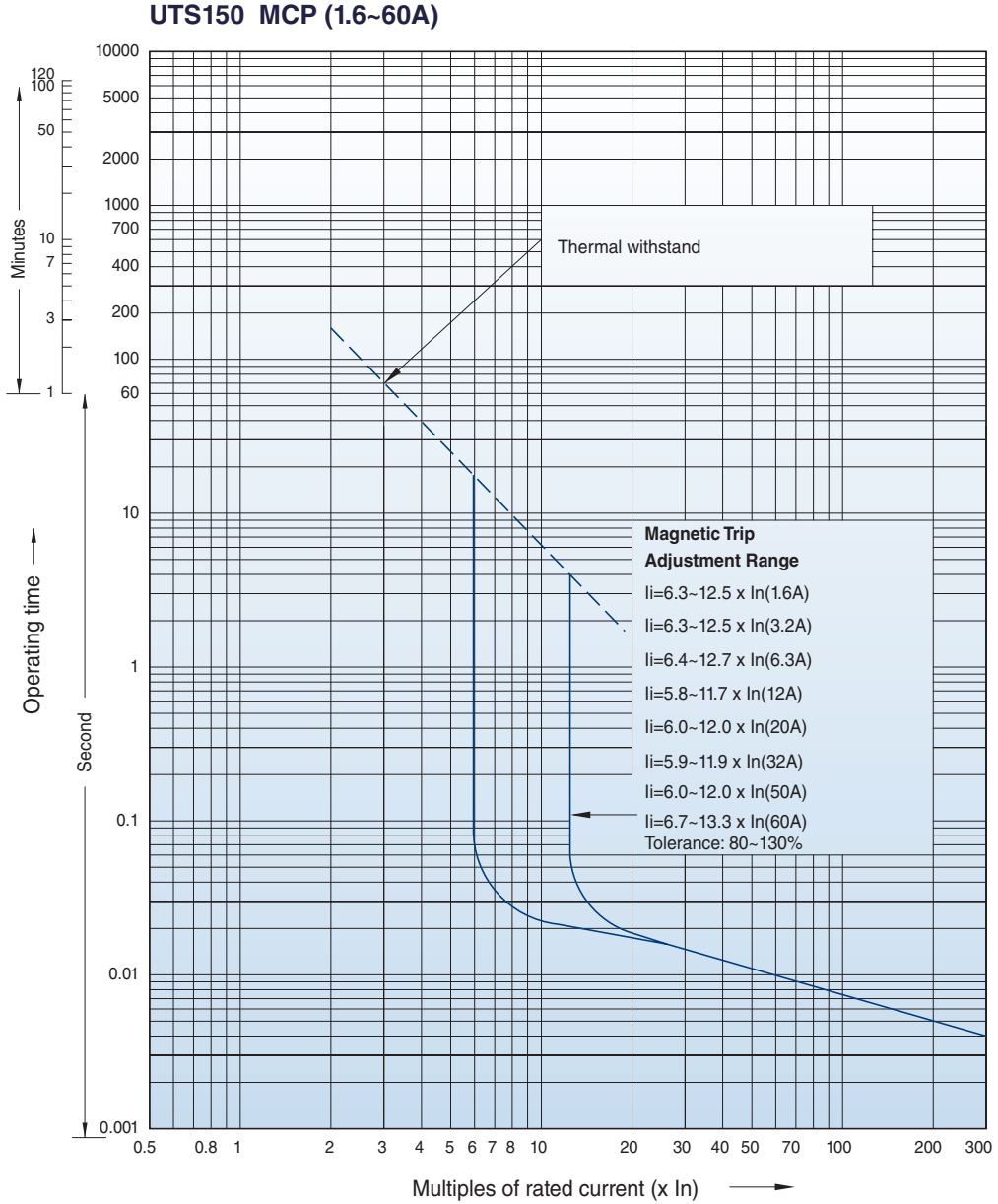

RATING UTS150	MCP (3P)
	MAG TRIP (80%~130%) (5.8~13.3 x In)
1.6	10~20A
3.2	20~40A
6.3	40~80A
12	70~140A
20	120~240A
32	190~380A
50	300~600A
60	400~800A

**UTS150 MCP (100~150A)**

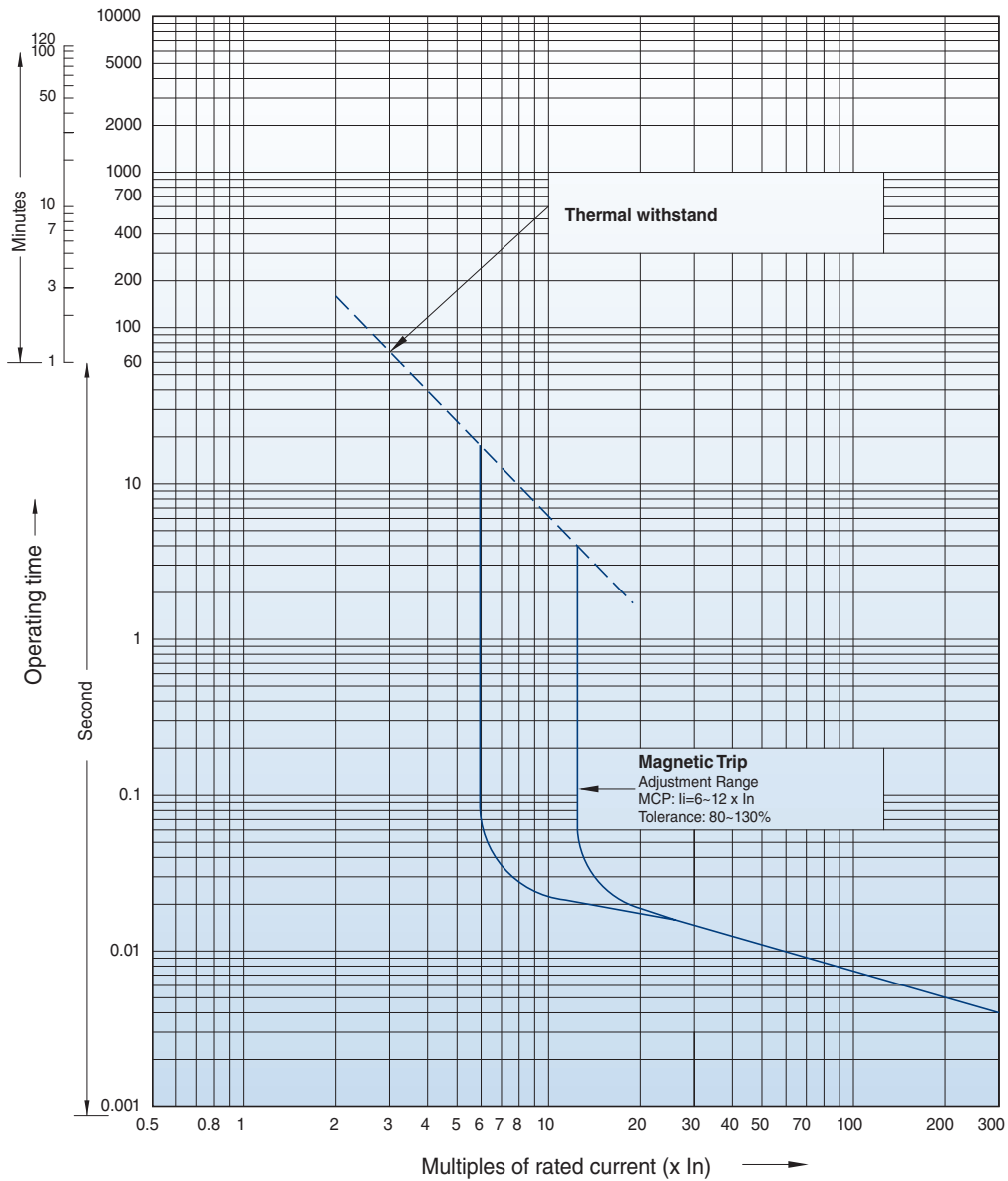

RATING UTS150	MCP (3P)
	MAG TRIP (80~130%) (6~12 x $I_n$ )
100	600~1200A
150	900~1800A

## UTS250 CHARACTERISTIC

This curve is to be used for application and coordination purposes only.  
All time/current characteristic curve data is based on 40°C ambient cold start.

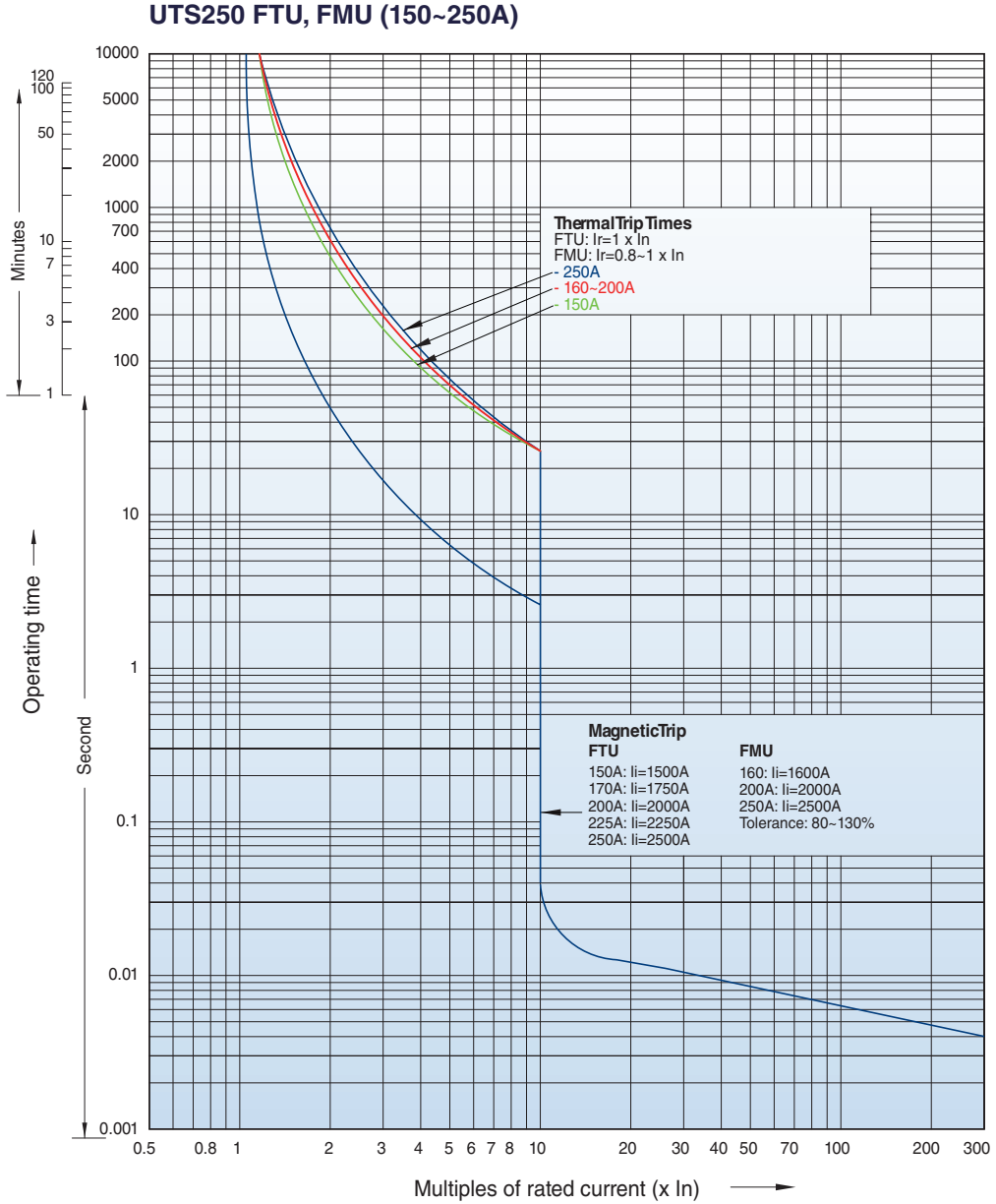

RATING UTS250	FTU	
	2P/3P	MAG TRIP (80%~130%)
150	○	1500A
175	○	1750A
200	○	2000A
225	○	2250A
250	○	2500A

RATING UTS250	FMU		
	2P/3P	RATING RANGE (0.8~1 x In)	MAG TRIP (80%~130%)
160	○	128~160A	1600A
200	○	160~200A	2000A
250	○	200~250A	2500A

**UTS250 ATU (160~250A)**

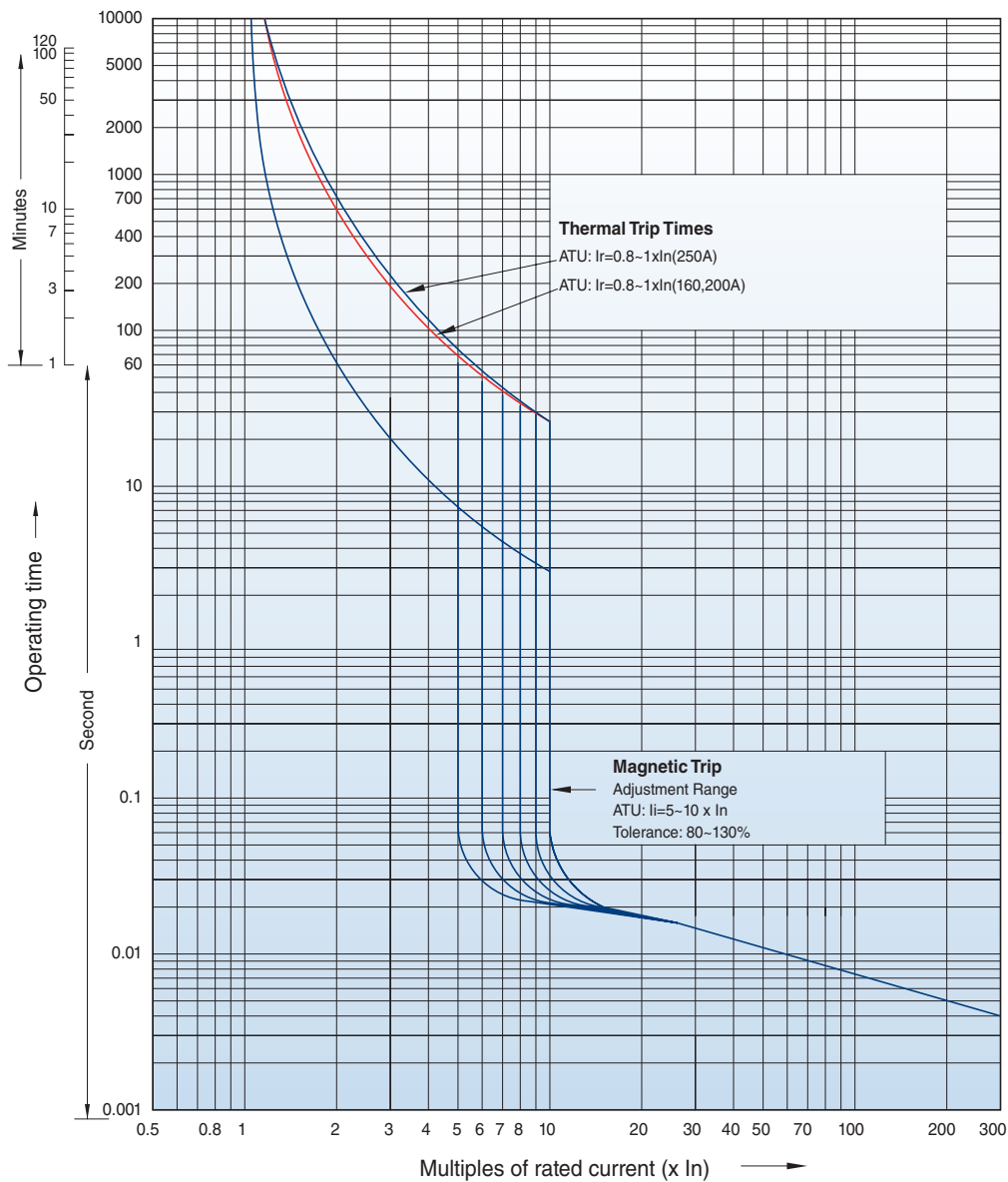

RATING UTS250	ATU		
	2P/3P	RATING RANGE ( $0.8\sim 1 \times I_n$ )	MAG TRIP (80%~130%) ( $5\sim 10 \times I_n$ )
160	○	128~160A	800~1600A
200	○	160~200A	1000~2000A
250	○	200~250A	1250~2500A

## UTS250 CHARACTERISTIC

This curve is to be used for application and coordination purposes only.  
All time/current characteristic curve data is based on 40°C ambient cold start.

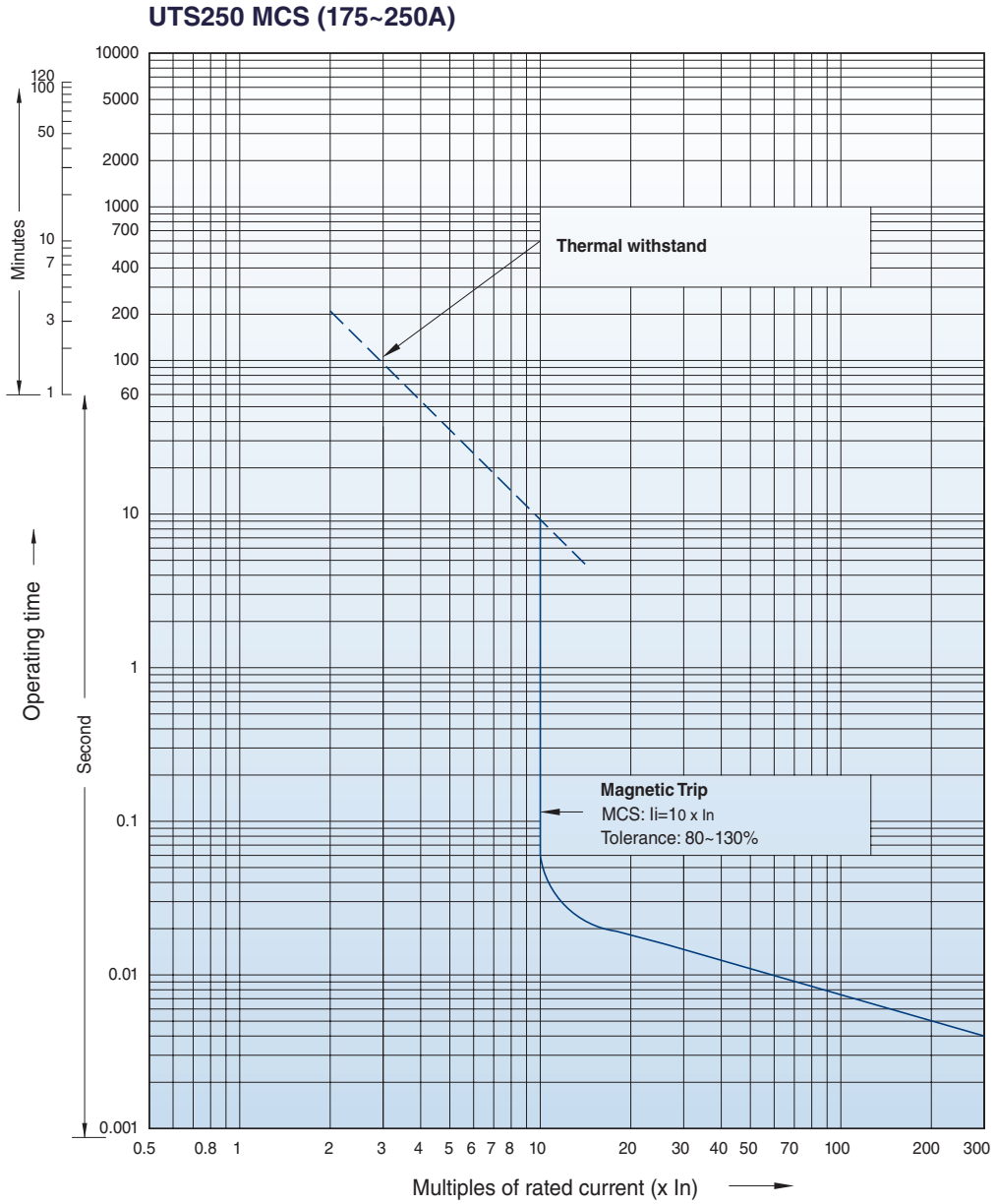

RATING UTS250	MCS (2P/3P)
	MAG TRIP (80%~130%) (10 x In)
175	1750A
250	2500A



**UTS250 MCP (220A)**

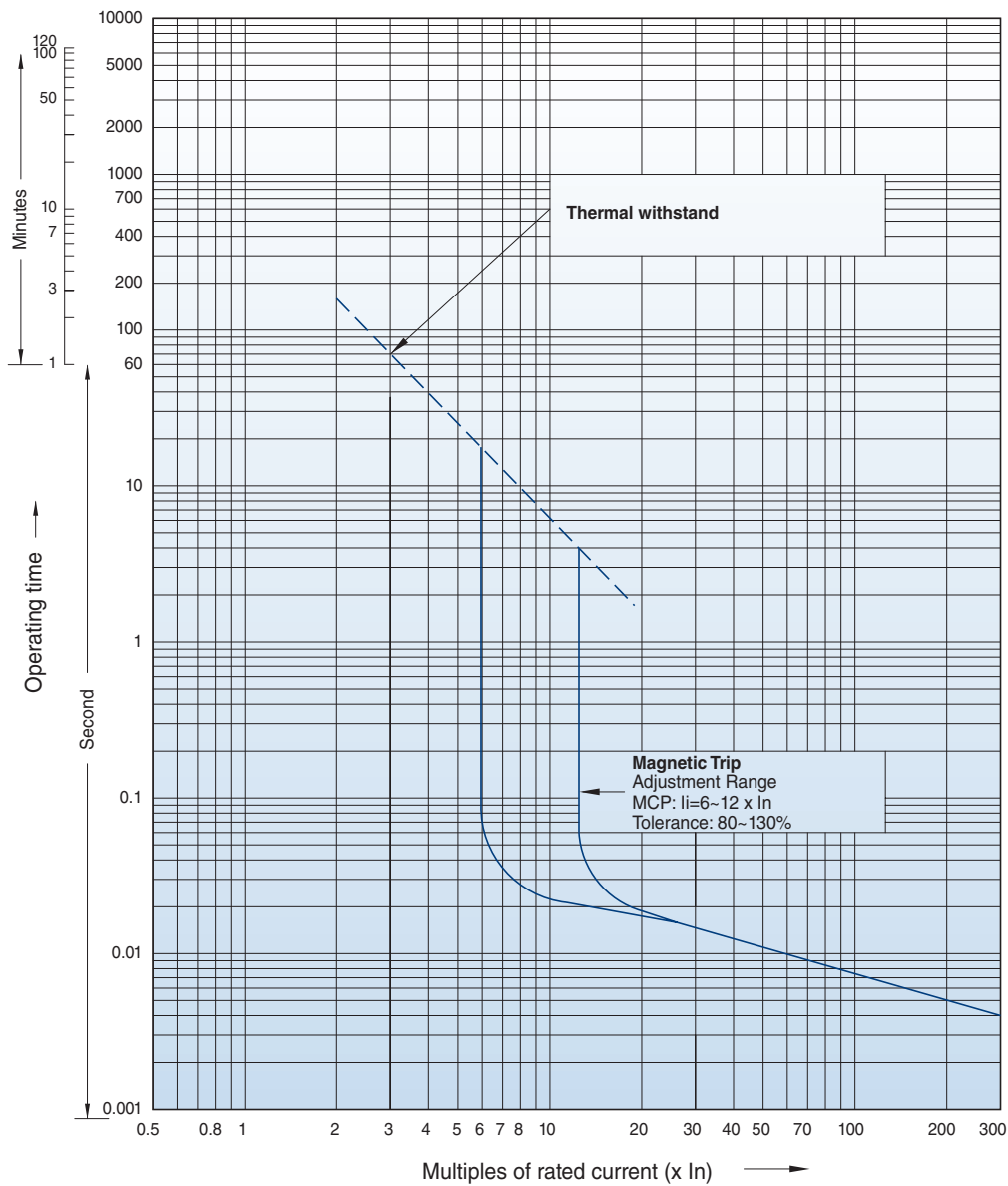

RATING UTS250	MCP (3P)
	MAG TRIP (80%~130%) (6~12 x $I_n$ )
220	1320~2640A

## UTS400 CHARACTERISTIC

This curve is to be used for application and coordination purposes only.  
All time/current characteristic curve data is based on 40°C ambient cold start.

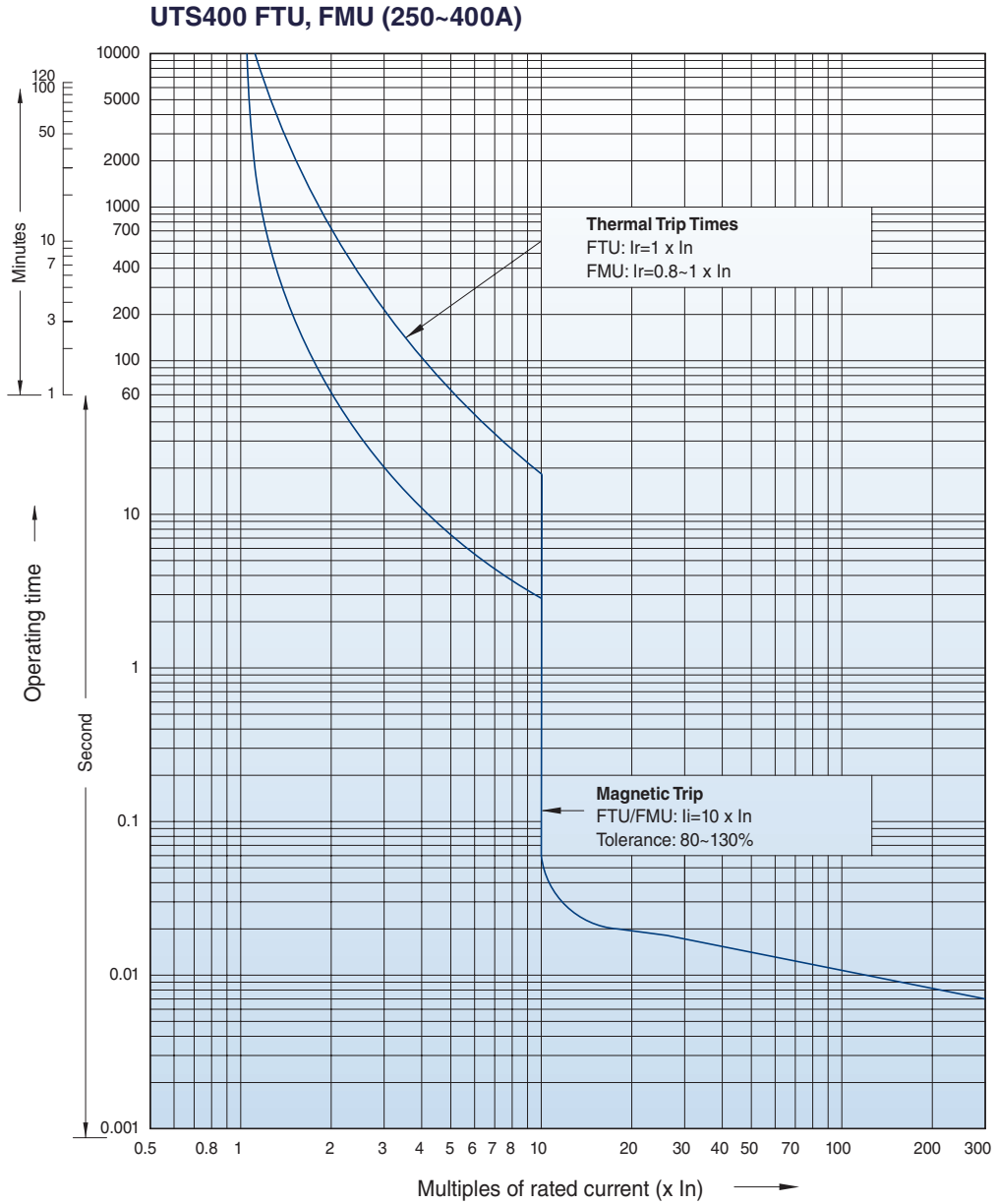

RATING UTS400	FTU	
	2P/3P	MAG TRIP (80%~130%)
250	○	2500A
300	○	3000A
350	○	3500A
400	○	4000A

RATING UTS400	FMU		
	2P/3P	RATING RANGE (0.8~1xIn)	MAG TRIP (80%~130%)
300	○	240~300A	3000A
400	○	320~400A	4000A

**UTS400 ATU (300~400A)**

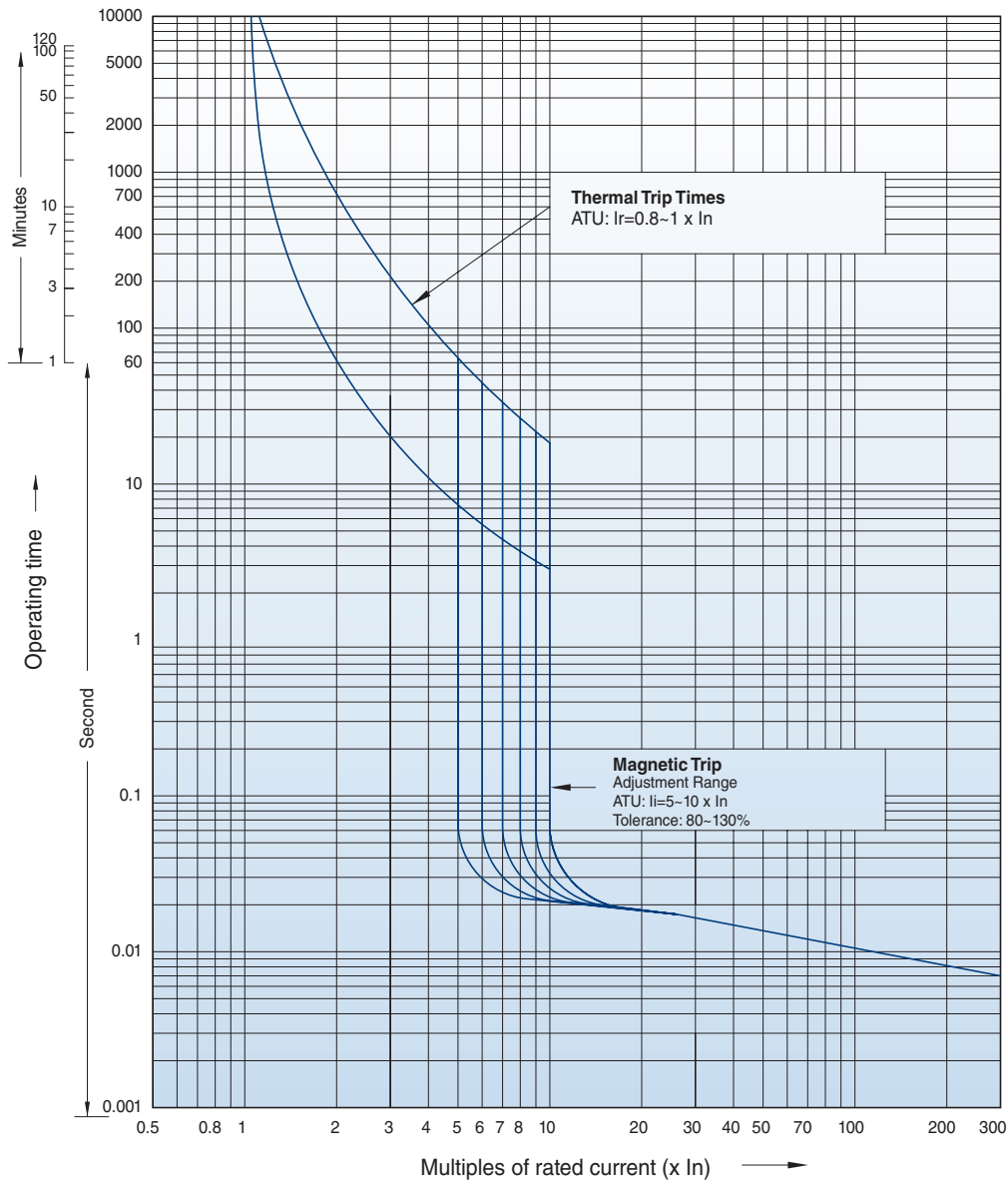

RATING UTS400	ATU		
	2P/3P	RATING RANGE (0.8~1 x In)	MAG TRIP (80%~130%) (5~10 x In)
300	○	240~300A	1500~3000A
400	○	320~400A	2000~4000A

## UTS400 CHARACTERISTIC

This curve is to be used for application and coordination purposes only.  
All time/current characteristic curve data is based on 40°C ambient cold start.

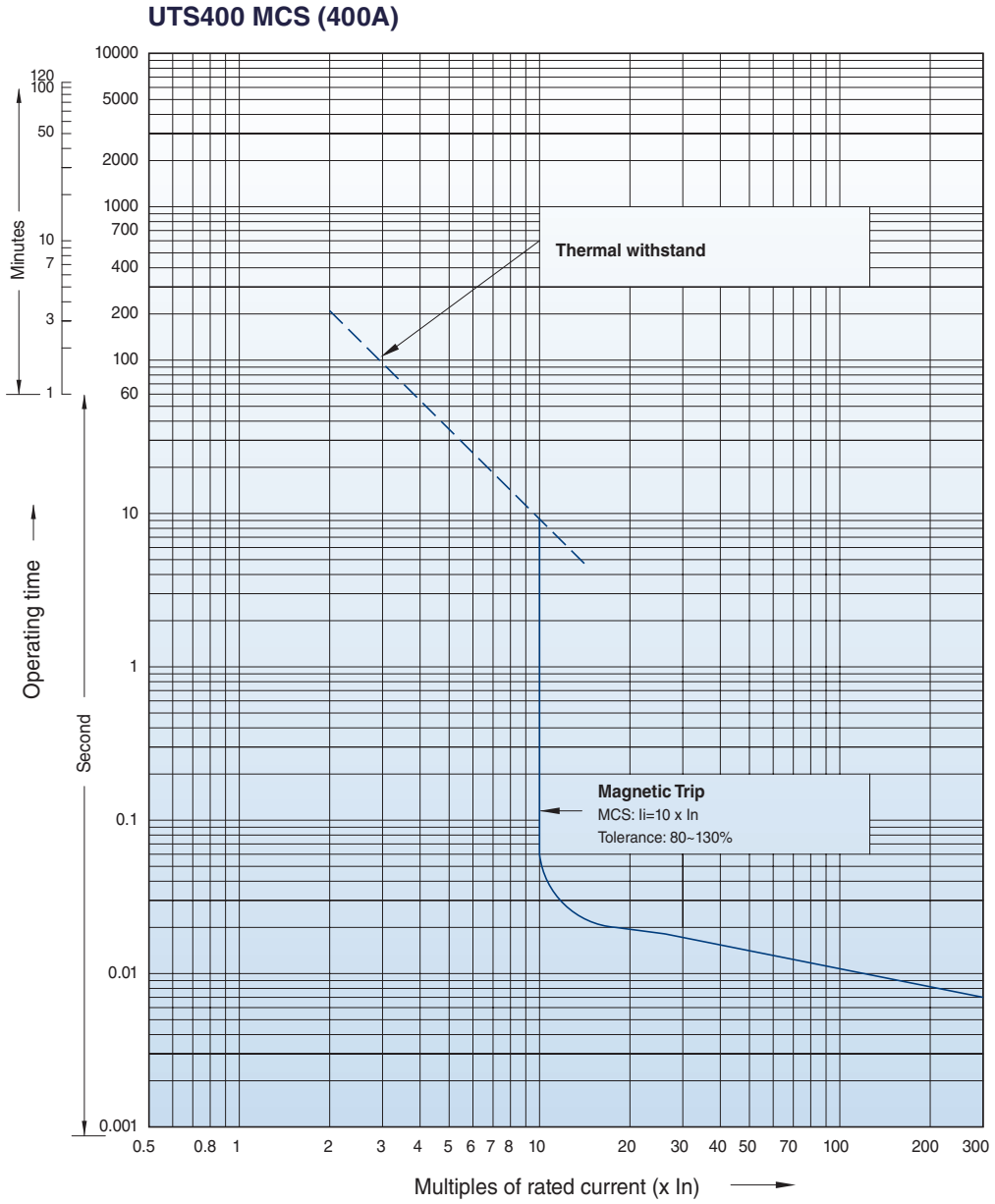

RATING UTS400	MCS (2P/3P)
	MAG TRIP (80%~130%) (10 x In)
400	4000A

**UTS400 MCP (320A)**

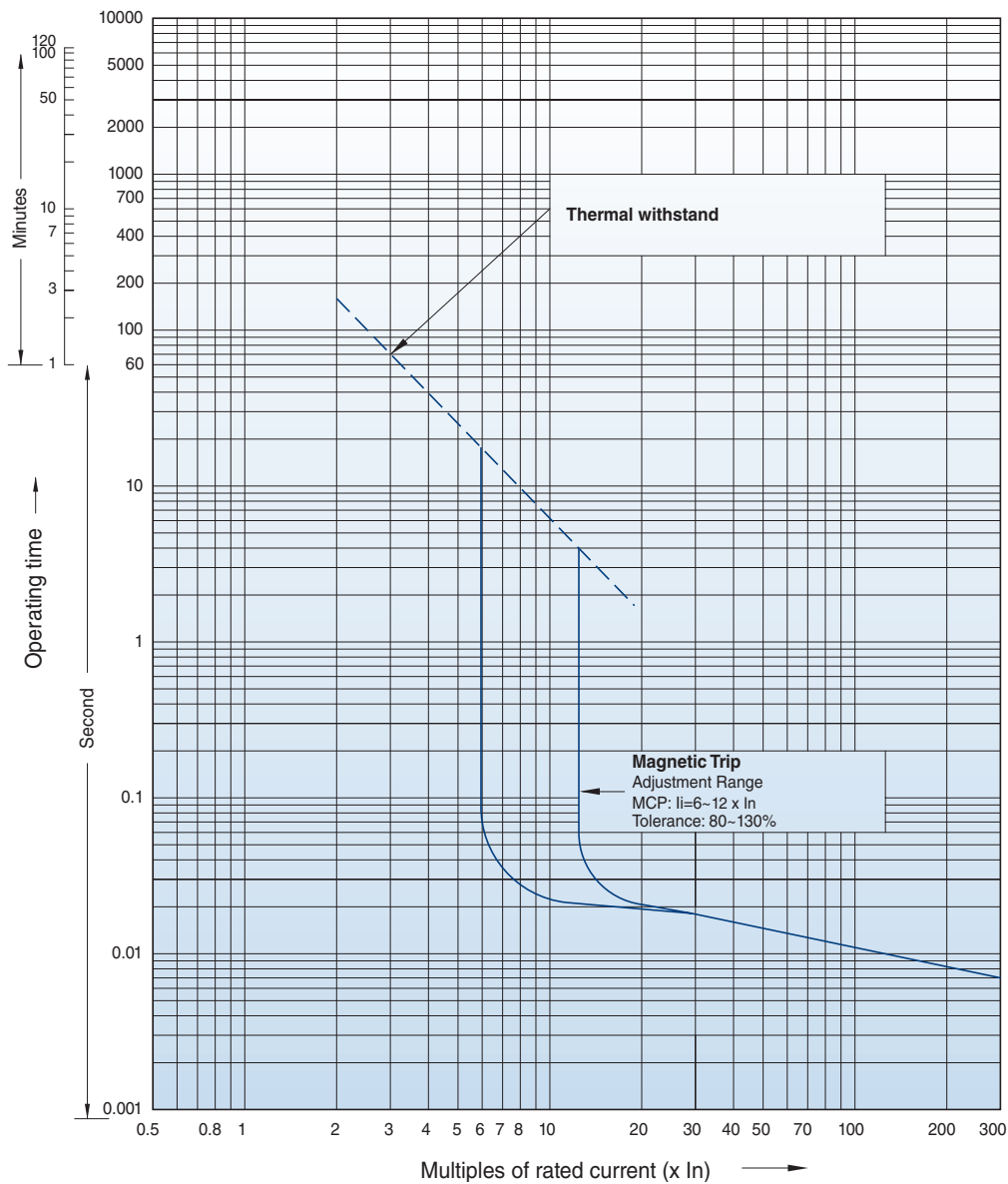

RATING UTS400	MCP (3P)
	MAG TRIP (80%~130%) (6~12 x $I_n$ )
320	1920~3840A

## UTS600 CHARACTERISTIC

This curve is to be used for application and coordination purposes only.  
All time/current characteristic curve data is based on 40°C ambient cold start.

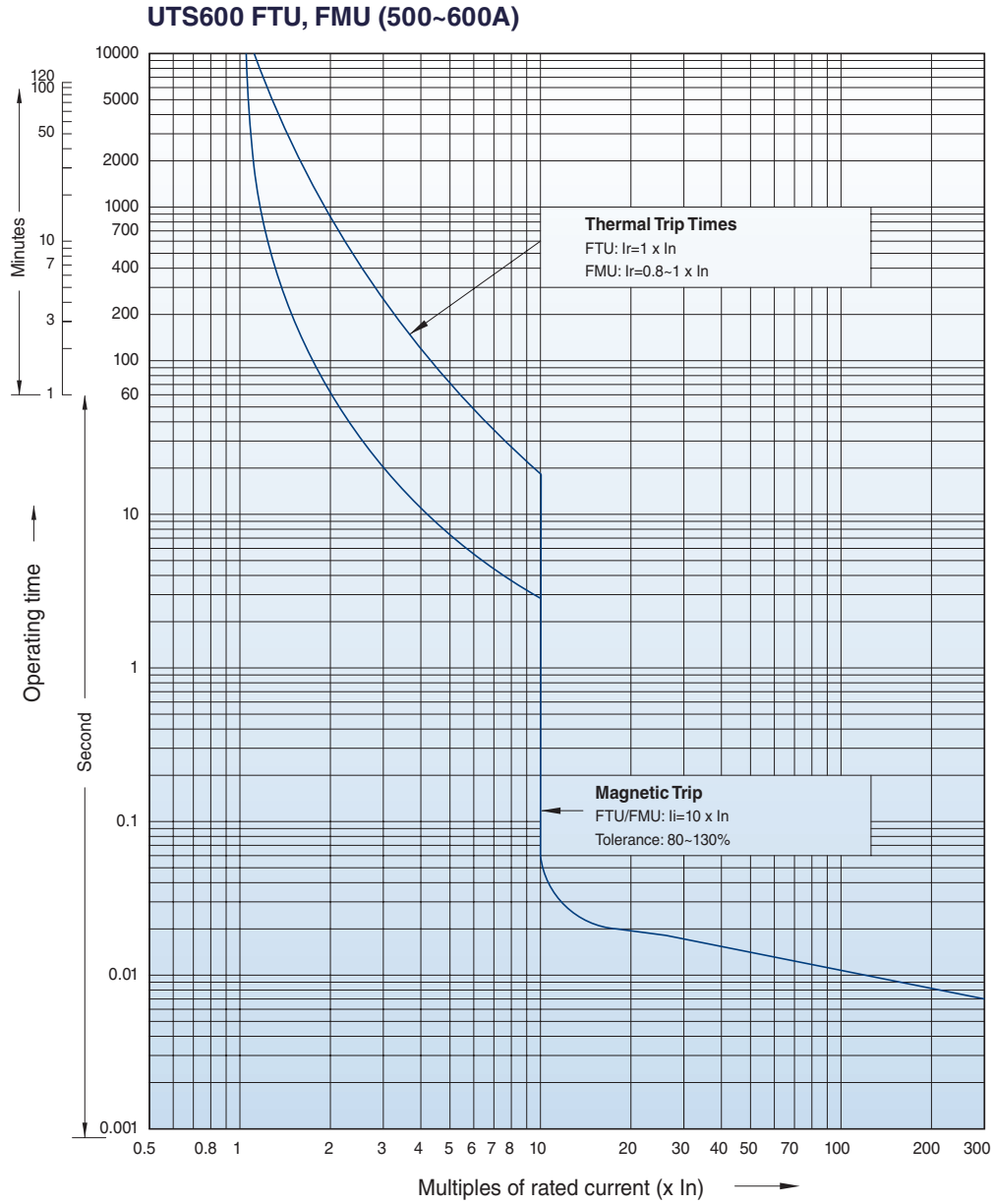

RATING UTS600	FTU	
	2P/3P	MAG TRIP (80%~130%)
500	○	5000A
600	○	6000A

RATING UTS600	2P/3P	FMU	
		RATING RANGE (0.8~1xIn)	MAG TRIP (80%~130%)
500	○	400~500A	5000A
600	○	480~600A	6000A

**UTS600 ATU (500~600A)**

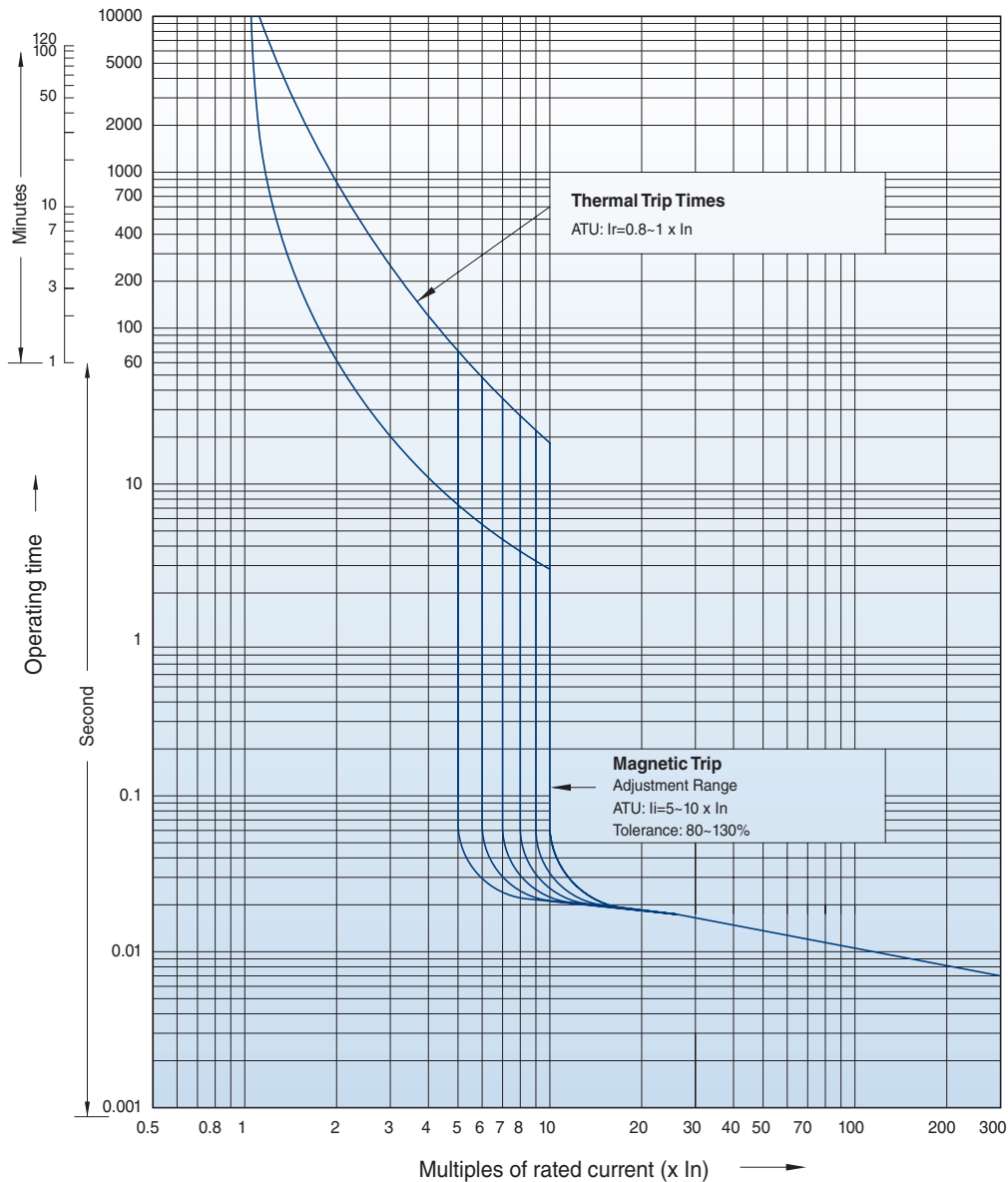

RATING UTS600	ATU		
	2P/3P	RATING RANGE (0.8~1 x $I_n$ )	MAG TRIP (80%~130%) (5~10 x $I_n$ )
500	○	400~500A	2500~5000A
600	○	480~600A	3000~6000A

## UTS600 CHARACTERISTIC

This curve is to be used for application and coordination purposes only.  
All time/current characteristic curve data is based on 40°C ambient cold start.

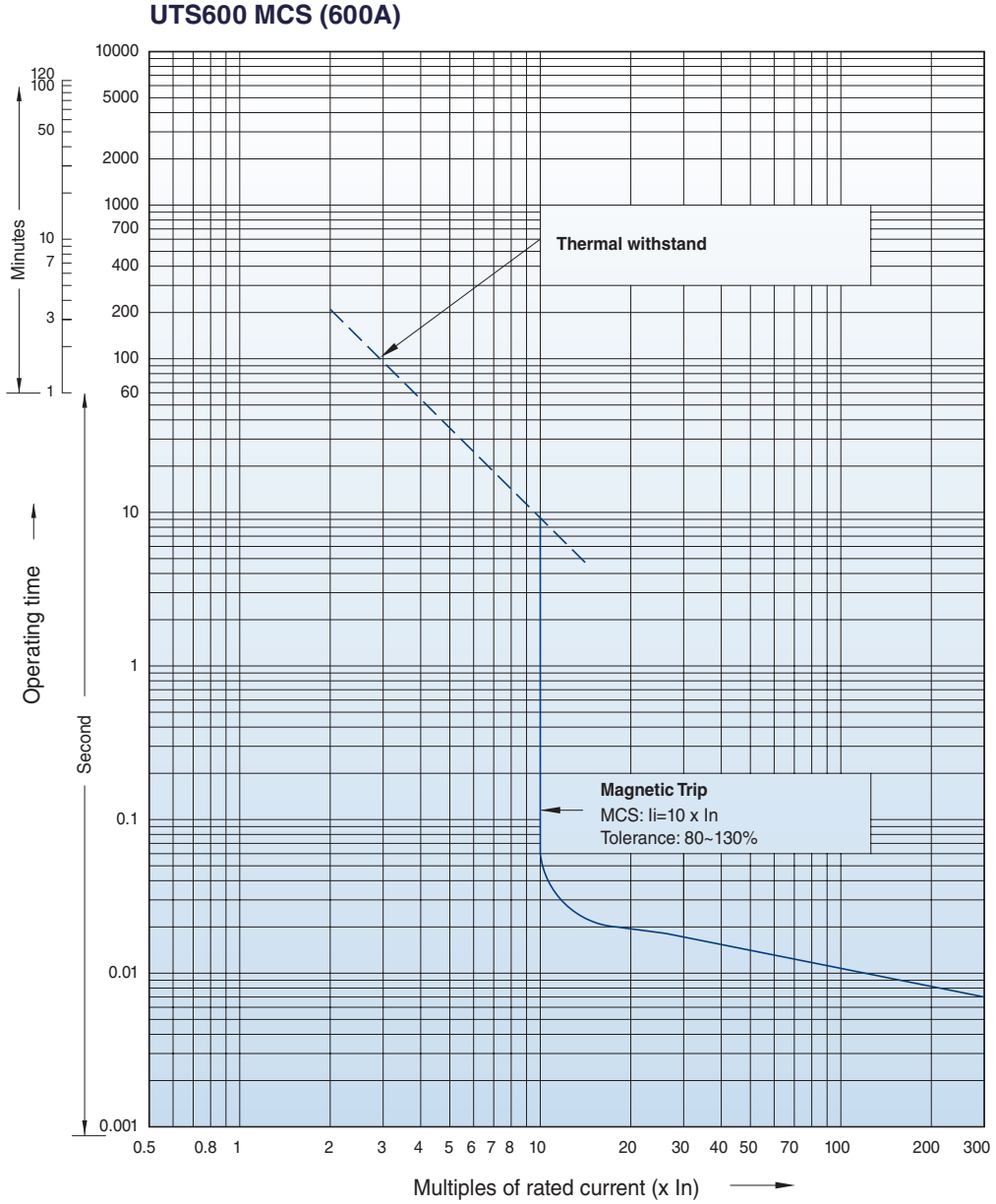

RATING UTS600	MCS (2P/3P)
	MAG TRIP (80%~130%) (10 x In)
600	6000A



**UTS600 MCP (500A)**

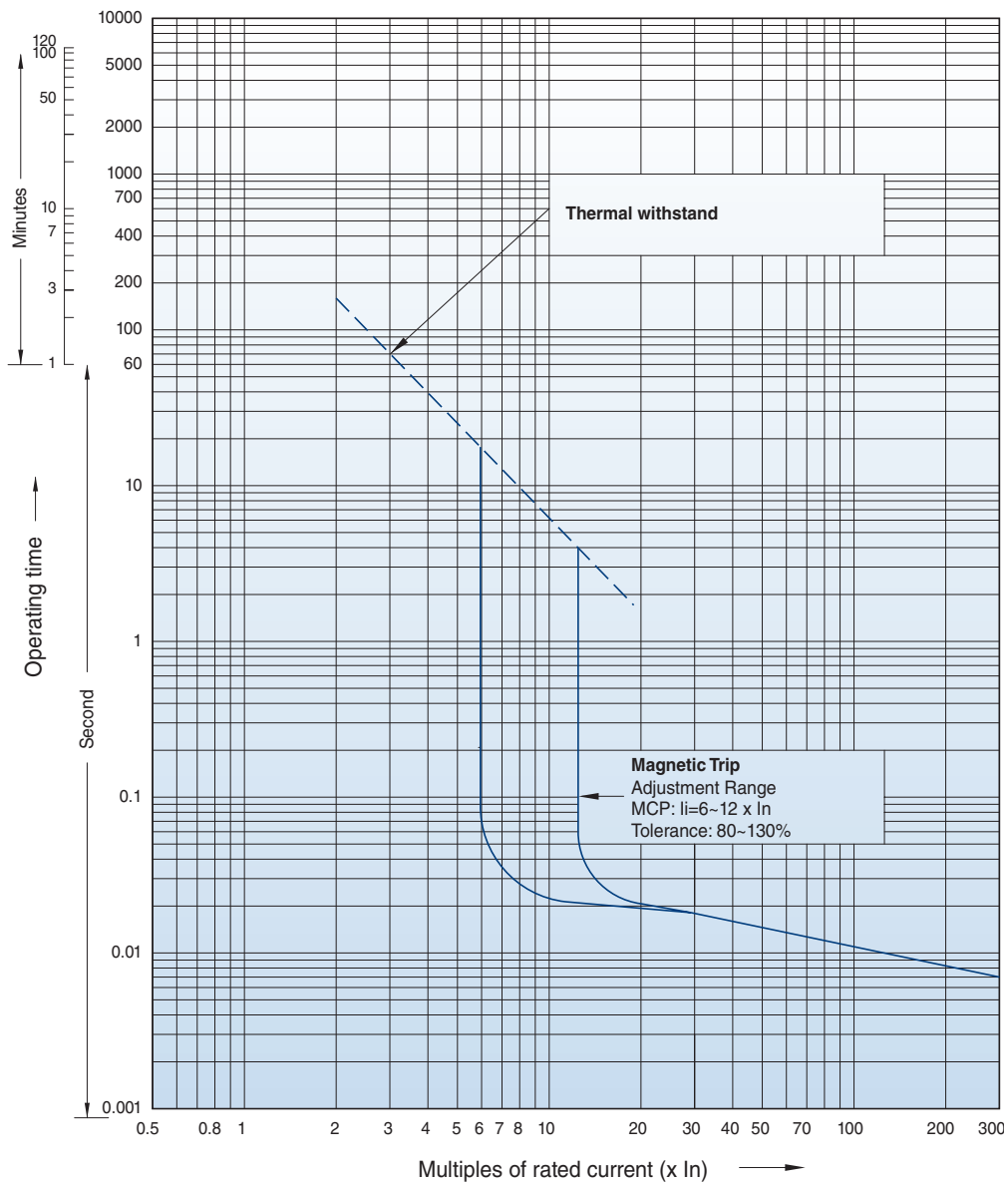

RATING UTS600	MCP (3P)
	MAG TRIP (80%~130%) (6~12xIn)
500	3000~6000A

## ELECTRONIC TRIP UNIT (ETS23, ETS33)

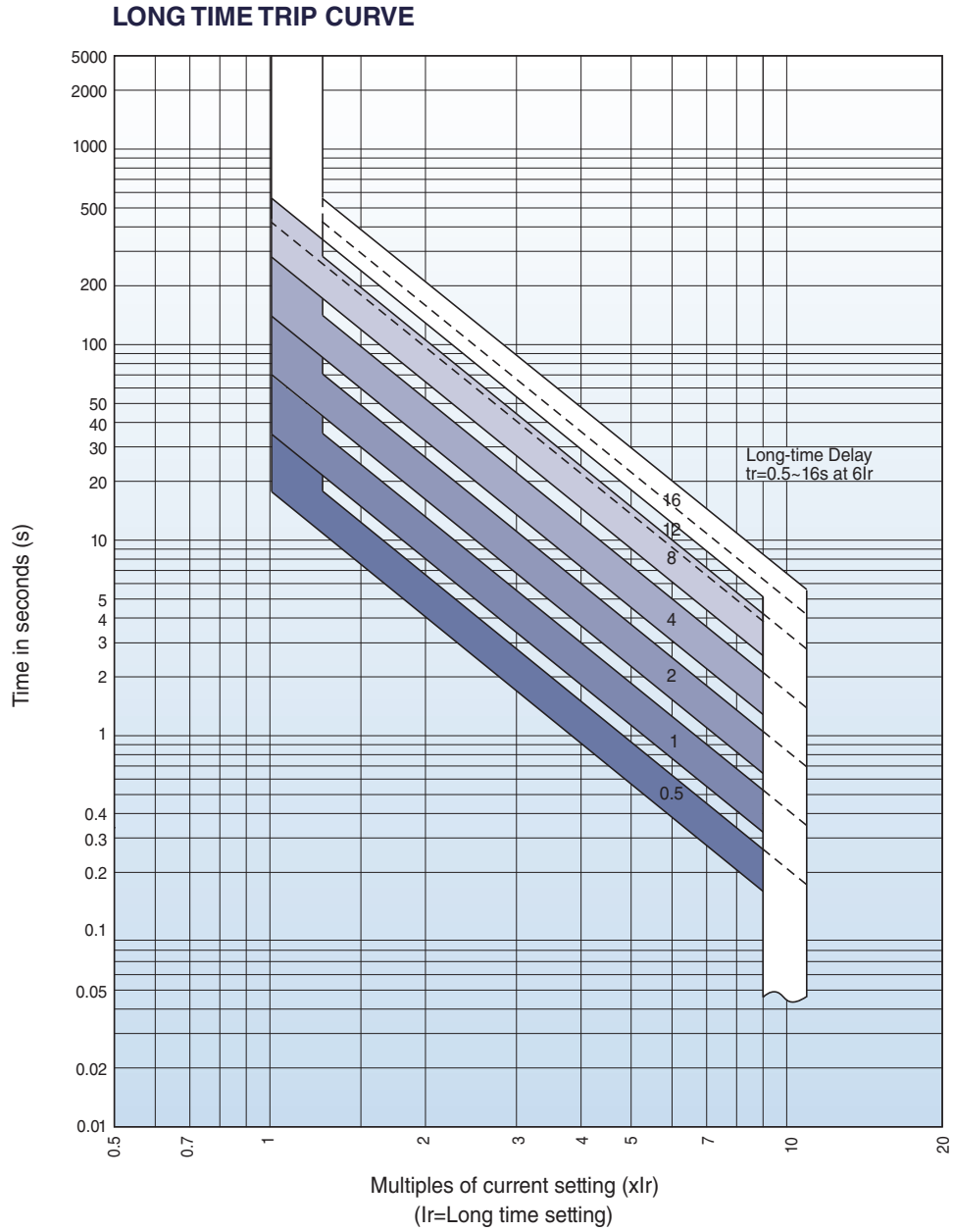

**SHORT TIME TRIP CURVE**

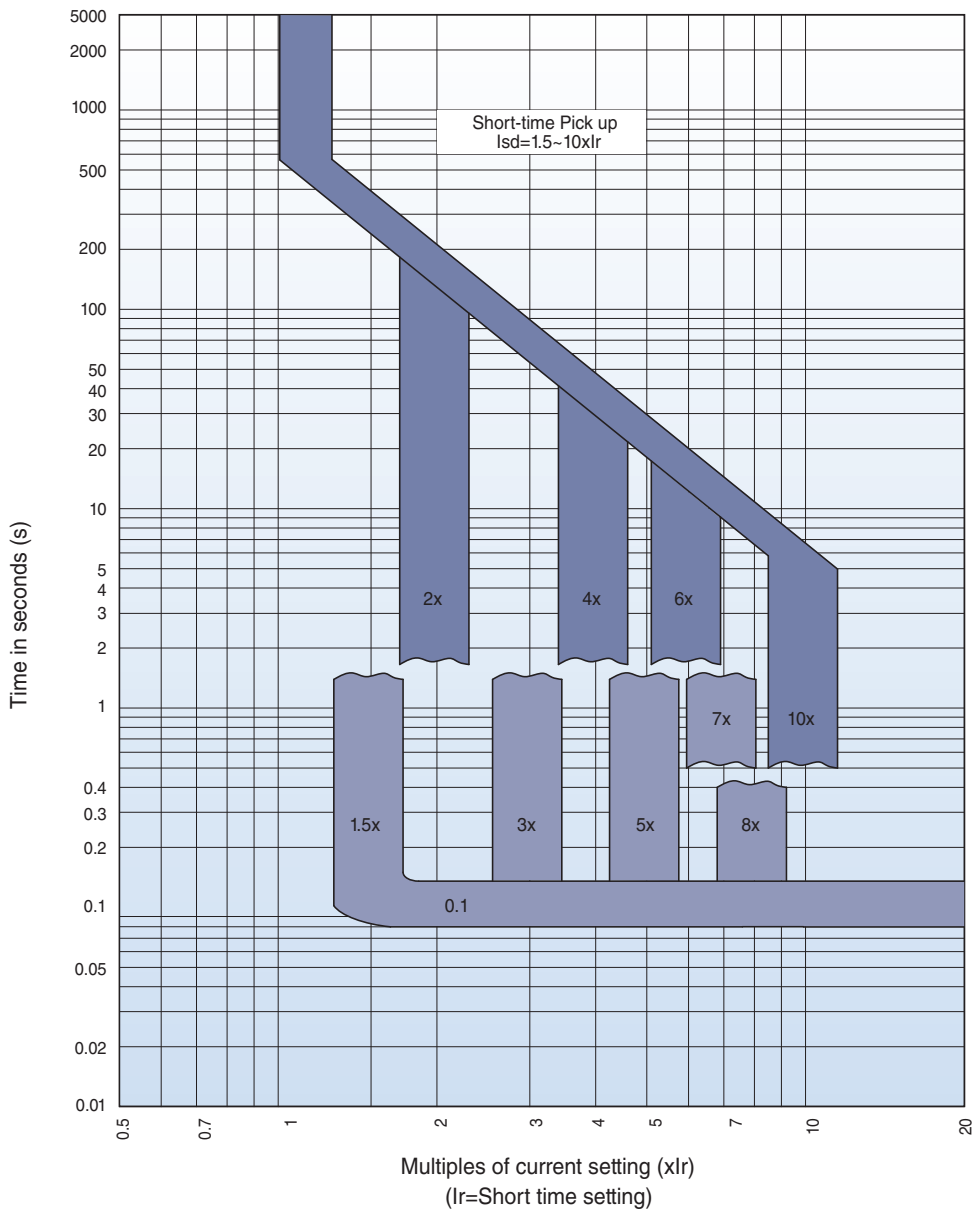

## ELECTRONIC TRIP UNIT (ETS23, ETS33)

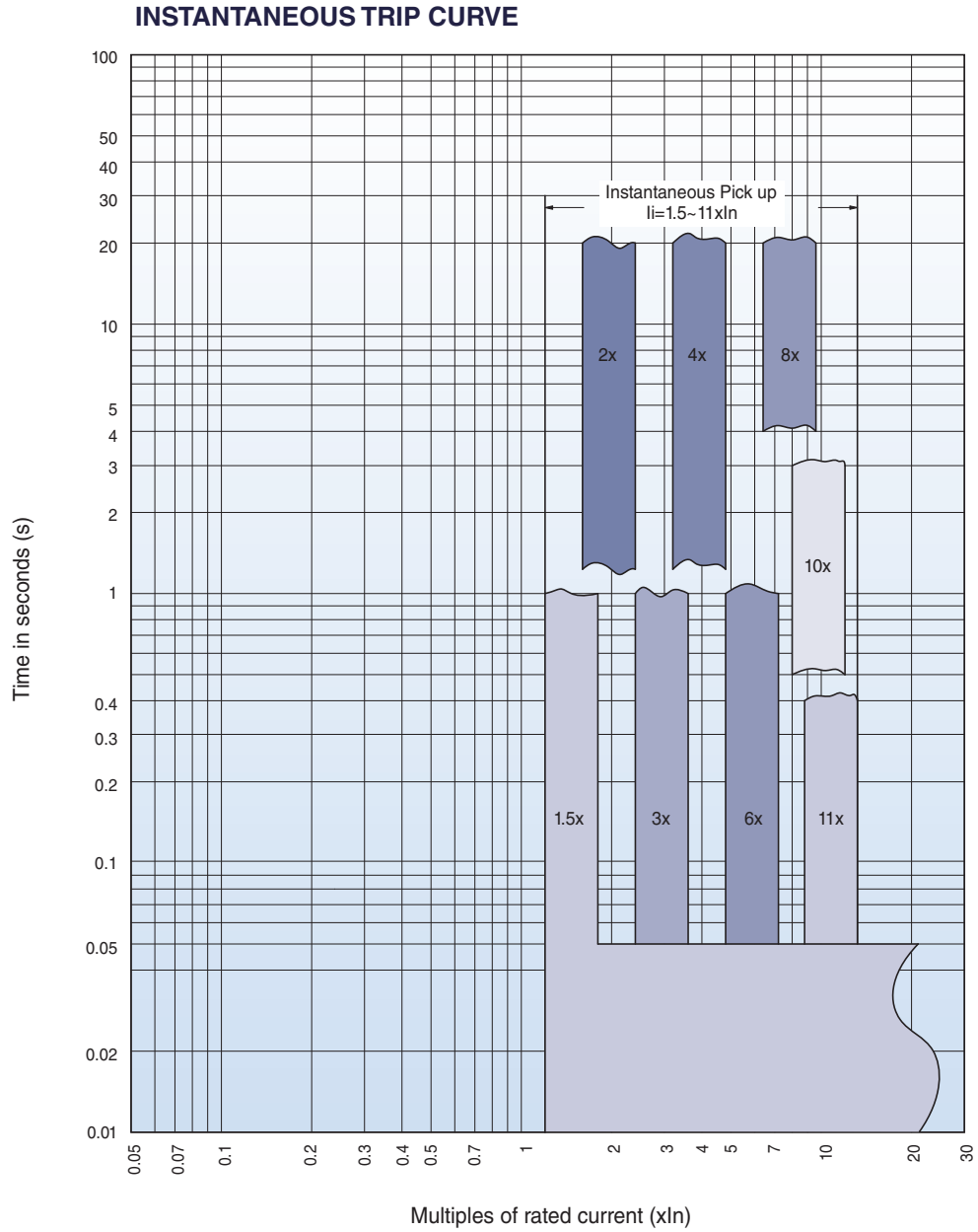

## ELECTRONIC TRIP UNIT (ETM33)

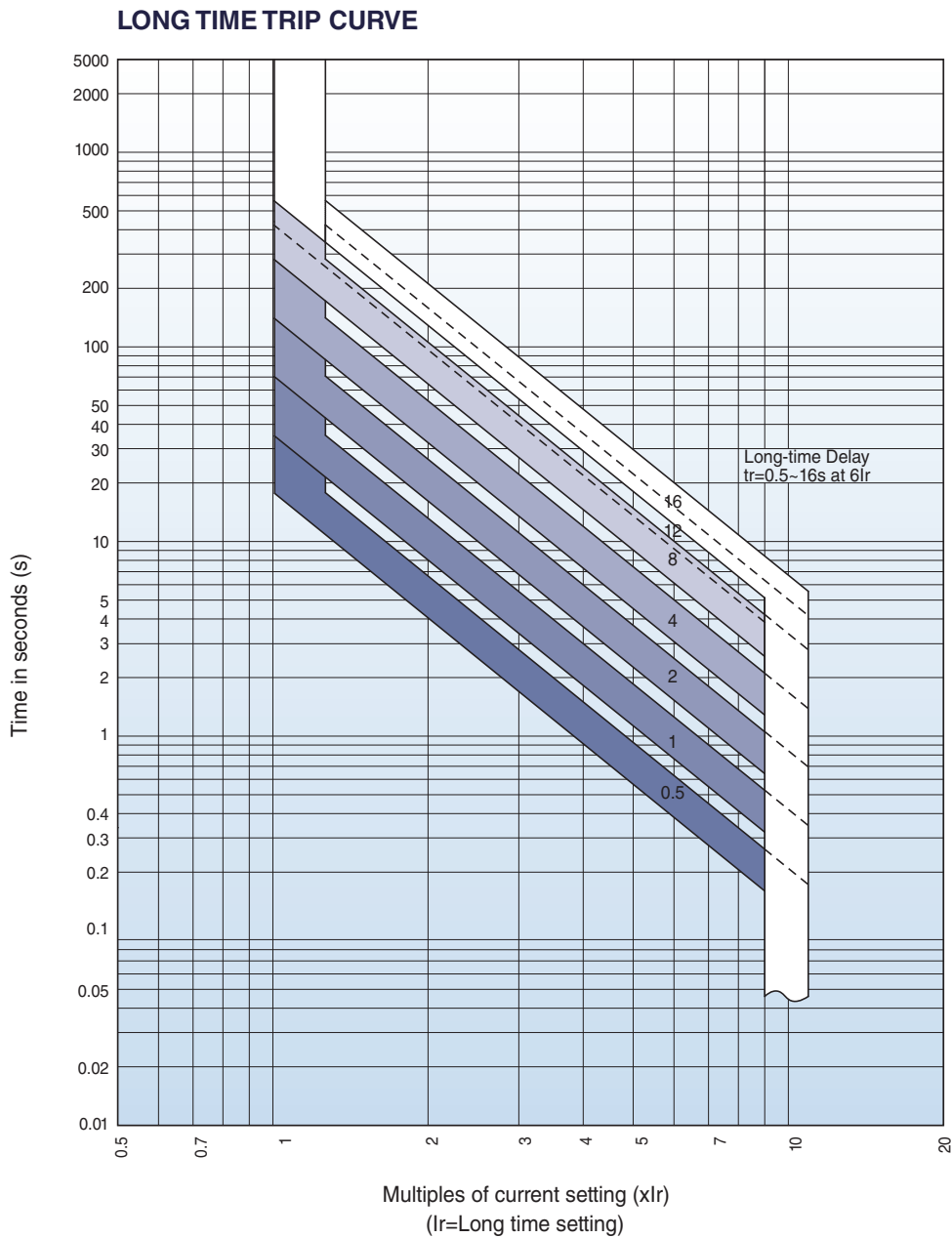

## ELECTRONIC TRIP UNIT (ETM33)

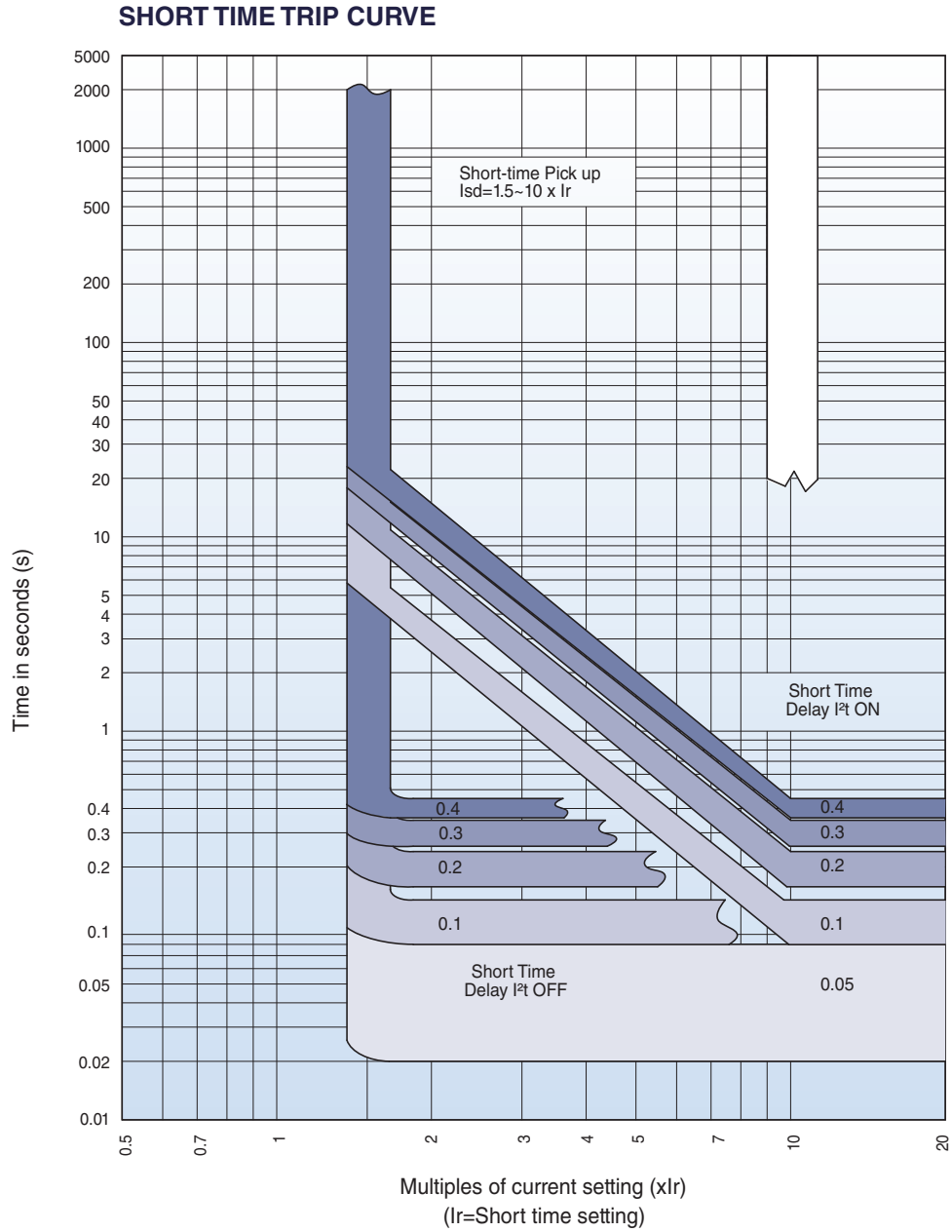

**INSTANTANEOUS AND GROUND FAULT CURVE**

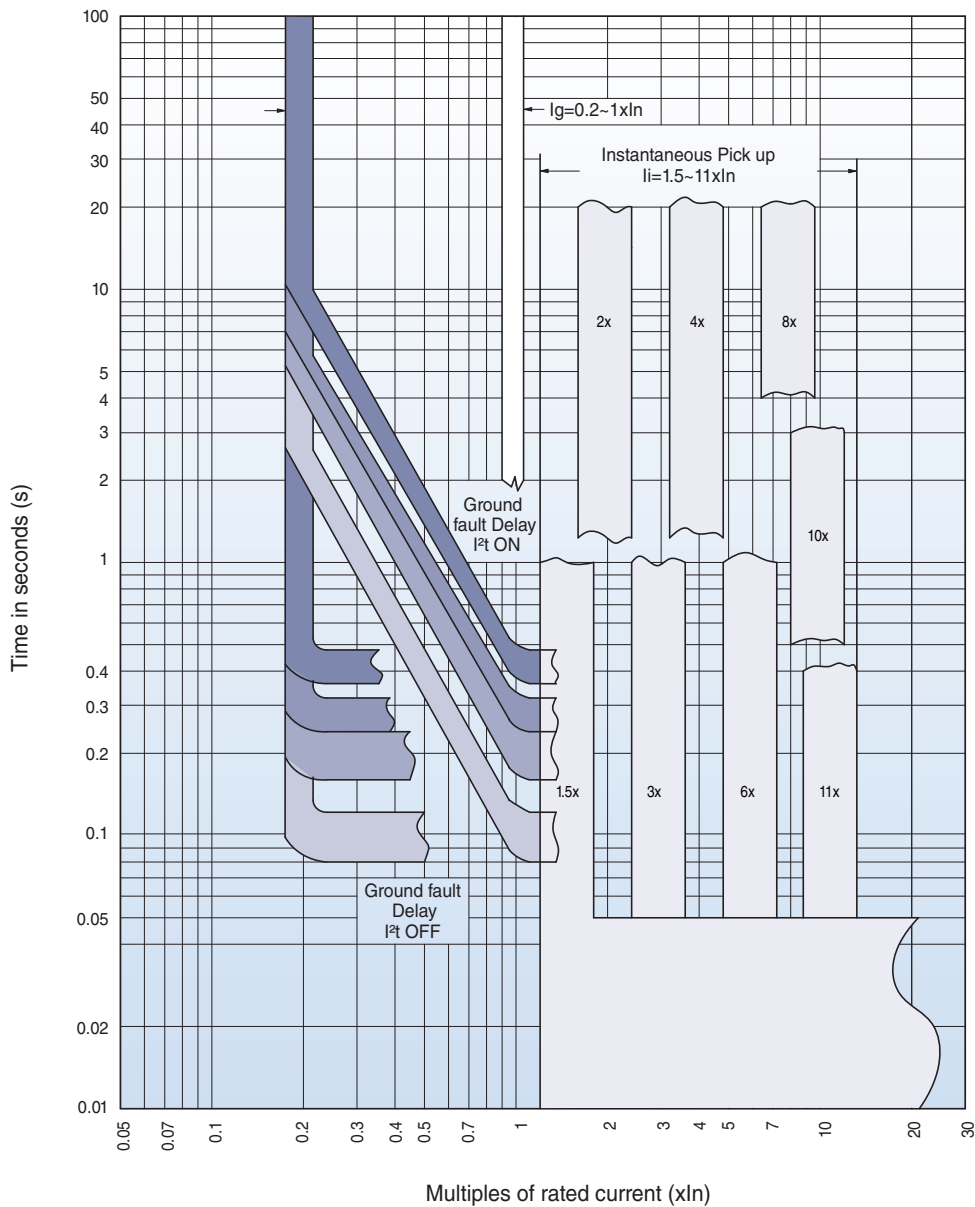

## UTS800/UTS1200 CHARACTERISTIC TRIP CURVES

This curve is to be used for application and coordination purposes only.

### LONG-TIME DELAY (400~1200A)

Long-time pickup  $0.4 \sim 1 \times I_r$   
and delay  $0.5 \sim 20s$

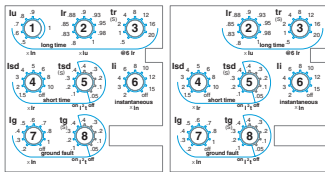

①, ②, ③ – Long-time setting

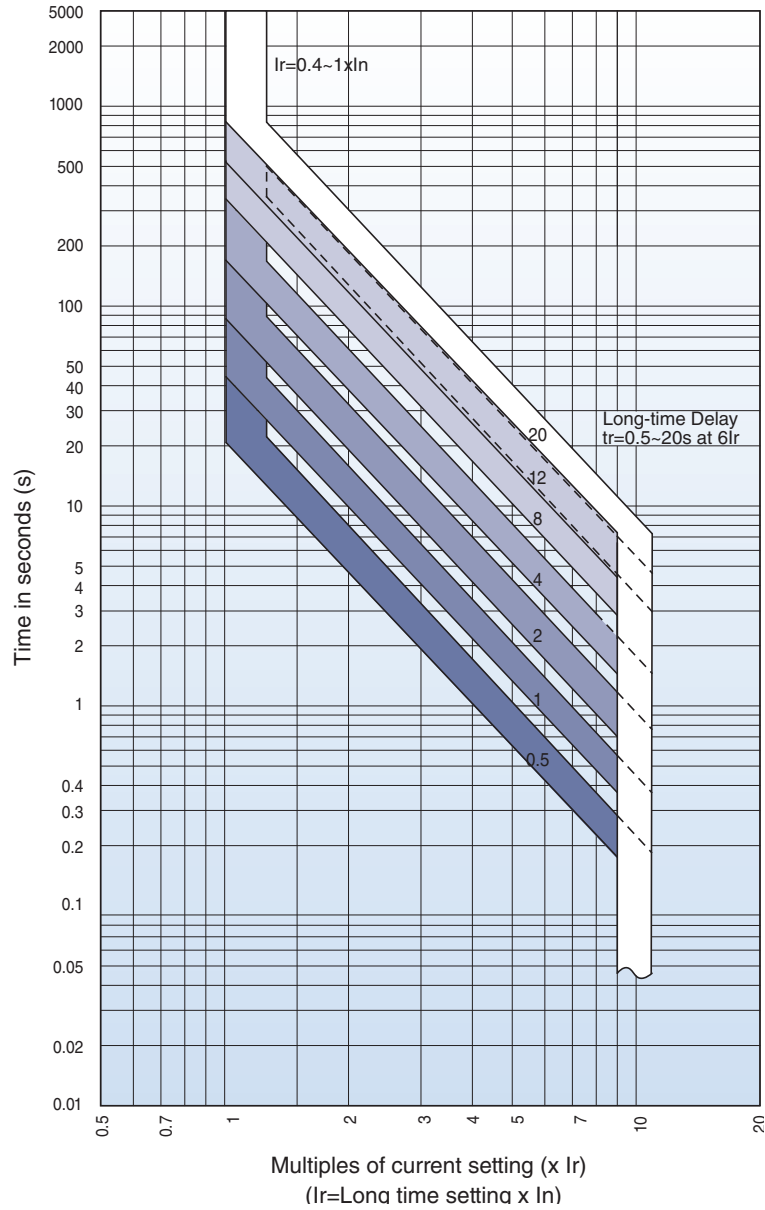

**Notes :**

1. There is a thermal-imaging effect that can act to shorten the long-time delay. The thermal imaging effect comes into play if a current above the long-time delay pickup value exists for a time and then is cleared by the tripping of a downstream device or the circuit breaker itself. A subsequent overload will cause the circuit breaker to trip in a shorter time than normal. The amount of time delay reduction is inverse to the amount of time that has elapsed since the previous overload.
2. Total clearing times shown include the response times of the trip unit, the circuit breaker opening, and the extinction of the current.



### SHORT-TIME DELAY (400~1200A)

Short-time pickup  $1.5 \sim 10 \times I_r$   
and delay  $0.1 \sim 0.4s$

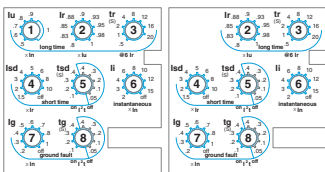

④, ⑤ – Short-time setting

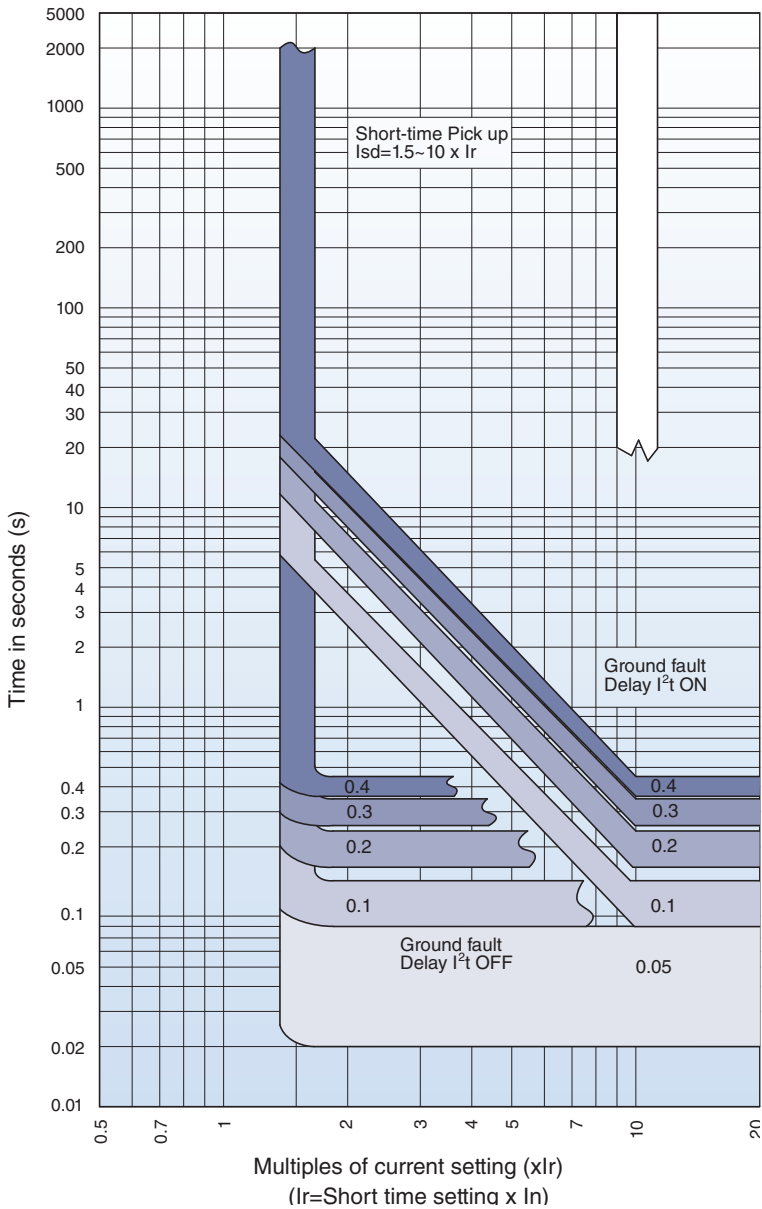

## UTS800/UTS1200 CHARACTERISTIC TRIP CURVES

This curve is to be used for application and coordination purposes only.

### INSTANTANEOUS AND GROUND FAULT (400~1200A)

Instantaneous pickup  $2 \sim 15 \times I_n$   
and Ground fault pickup  $0.2 \sim 1 \times I_n$   
and delay  $0.1 \sim 0.4s$

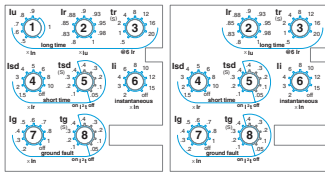

⑥, ⑦, ⑧ - Instantaneous and Ground fault setting

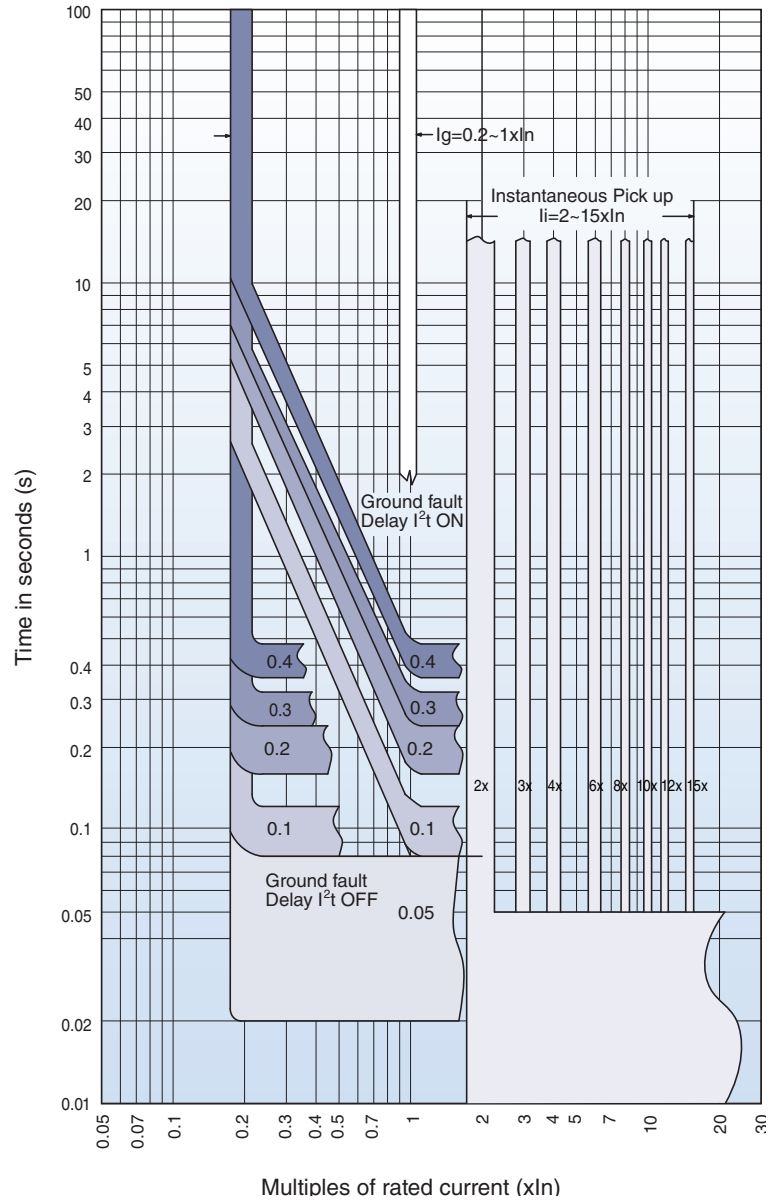

# MCP: ADJUSTABLE INSTANTANEOUS TRIP CURVE (800A)

## INSTANTANEOUS PICKUP 2~12 X I<sub>n</sub> AT 800A

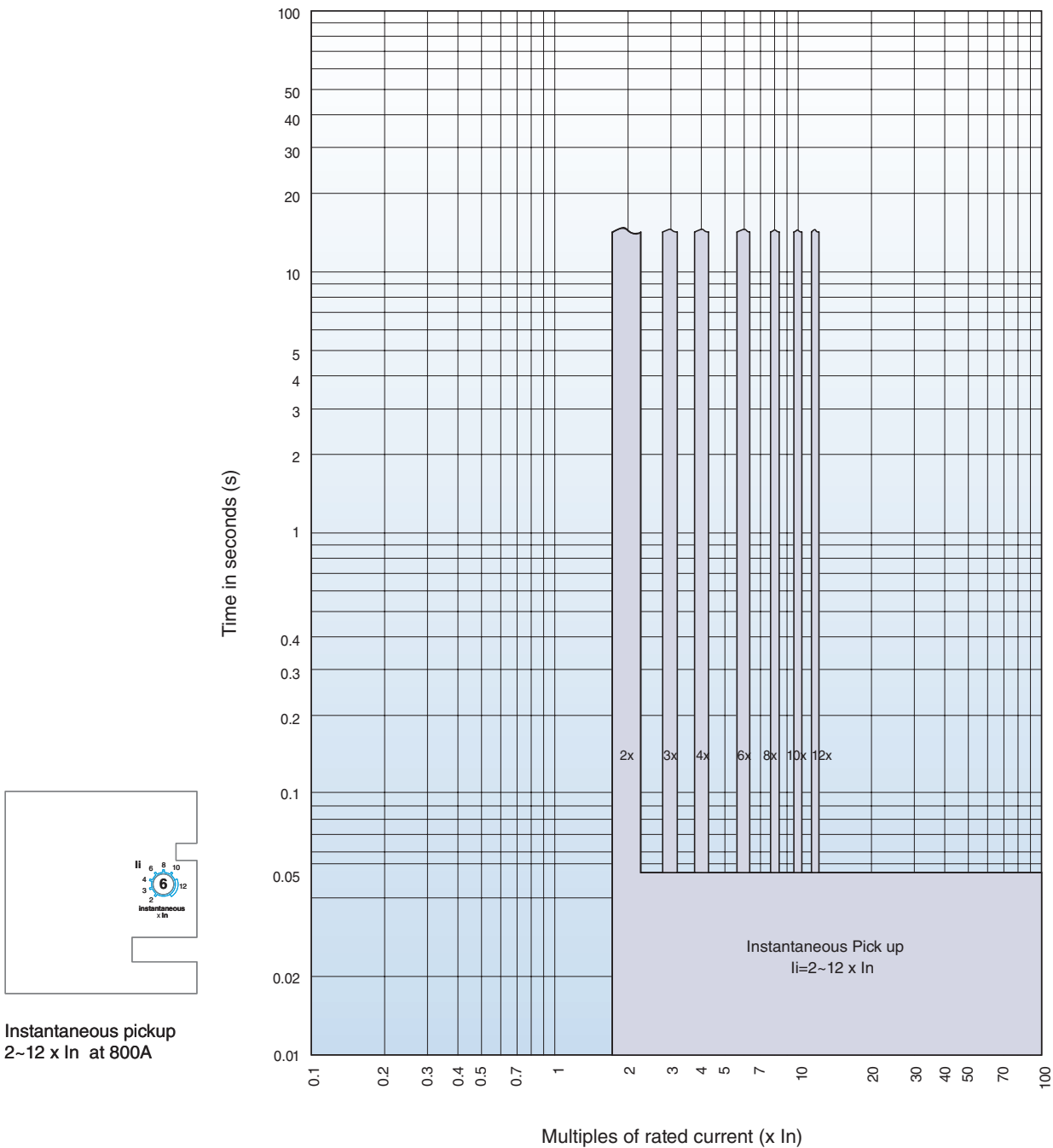

# MCP: ADJUSTABLE INSTANTANEOUS TRIP CURVE (1200A)

## INSTANTANEOUS PICKUP 2~8 X I<sub>n</sub> AT 1200A

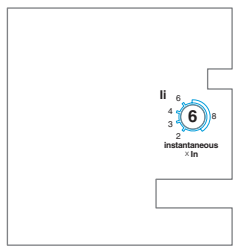

Instantaneous pickup  
2~8 x I<sub>n</sub> at 1200A

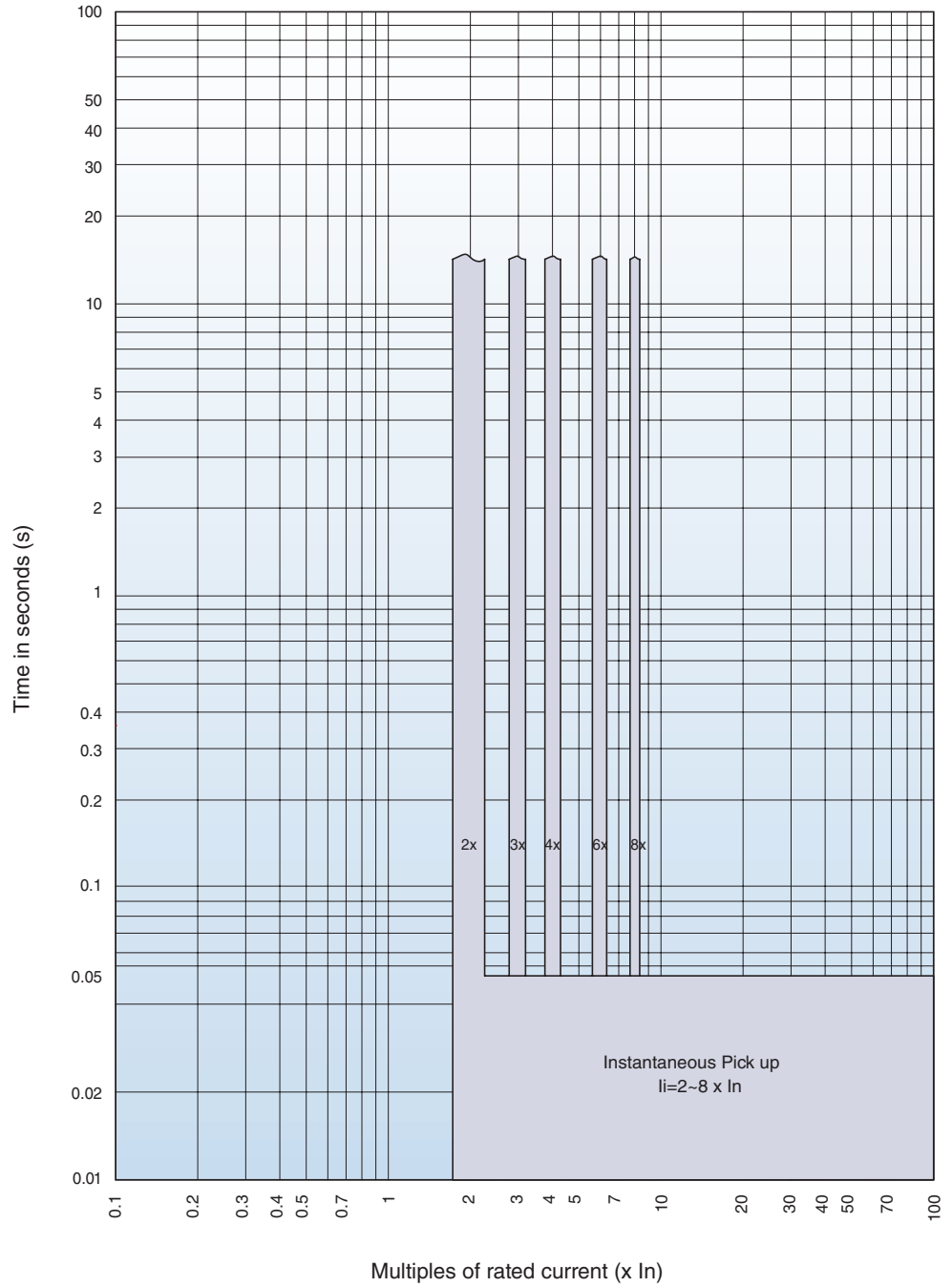

## MCS: FIXED INSTANTANEOUS TRIP CURVE (800~1200A)

### INSTANTANEOUS PICKUP 15 X $I_n$ AT 800A, 1200A

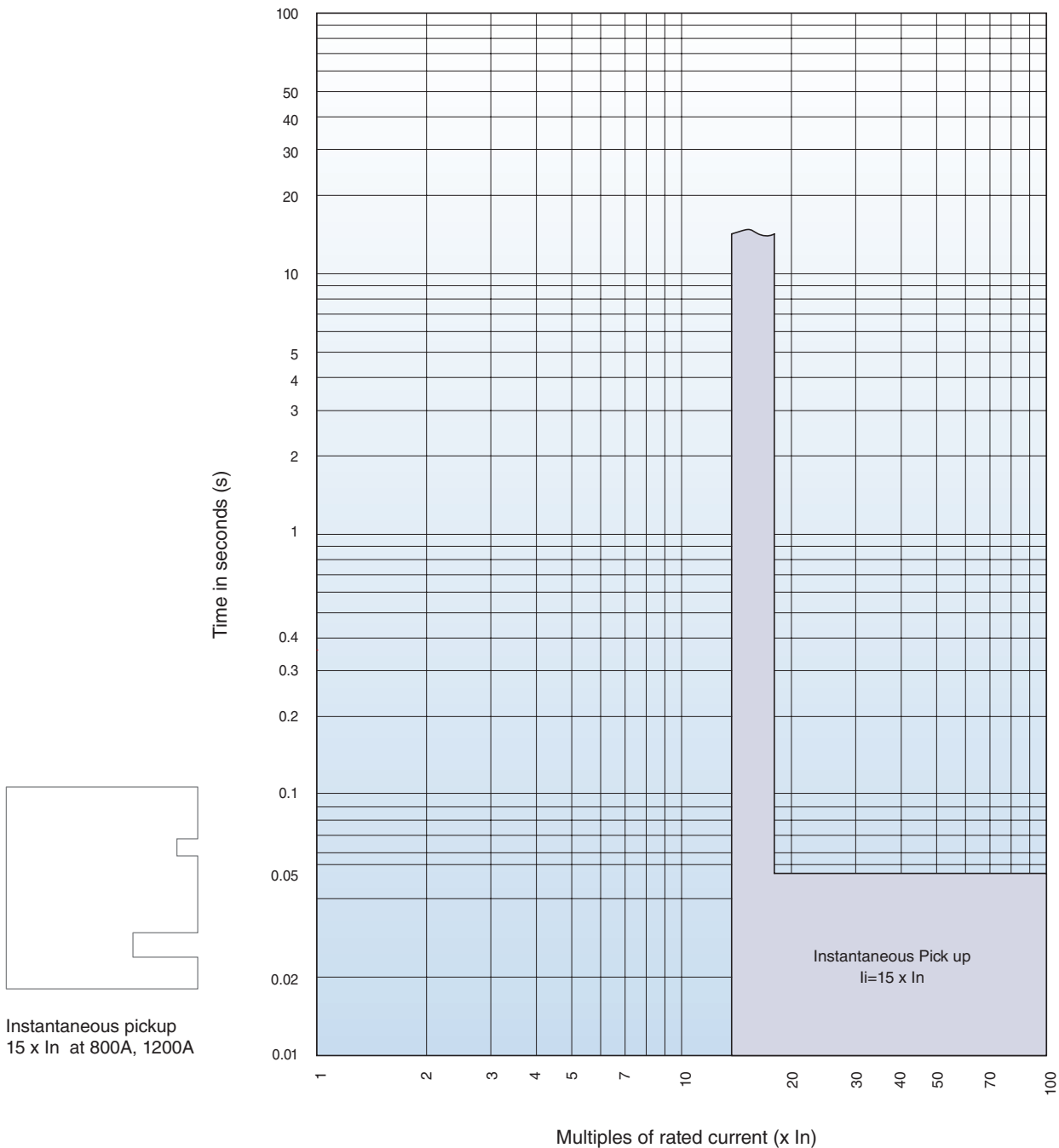

## UTE100 CHARACTERISTIC

Based on typical values obtained throughout the circuit breaker development and UL test programs.

### LET-THROUGH ENERGY $I^2t$ (240V, 480V AND 600V)

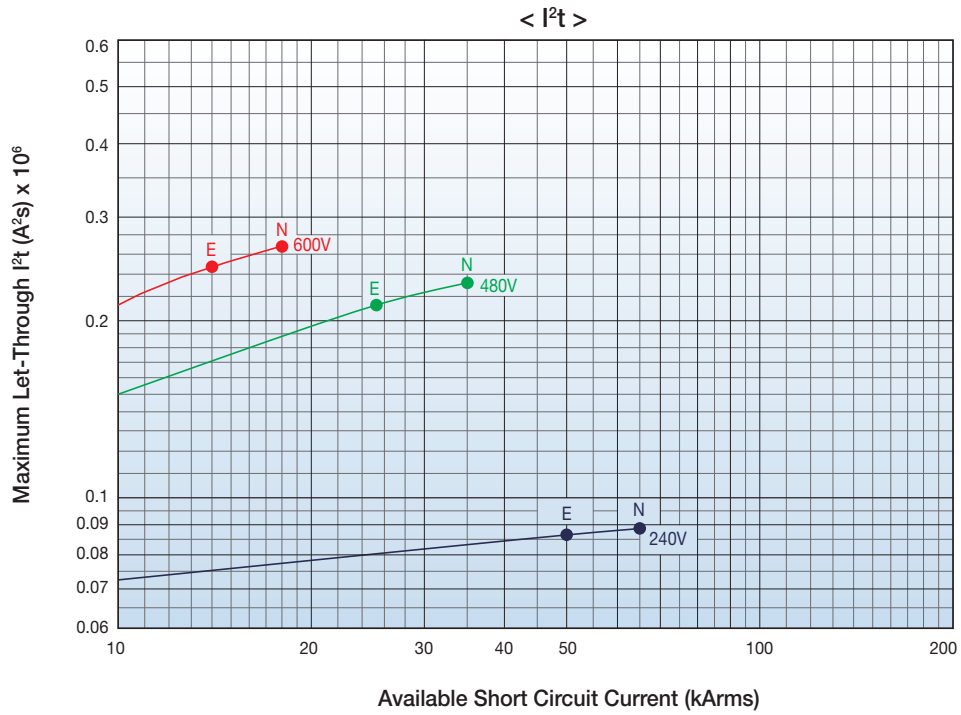

### PEAK LET-THROUGH CURRENT $I_p$ (240V, 480V AND 600V)

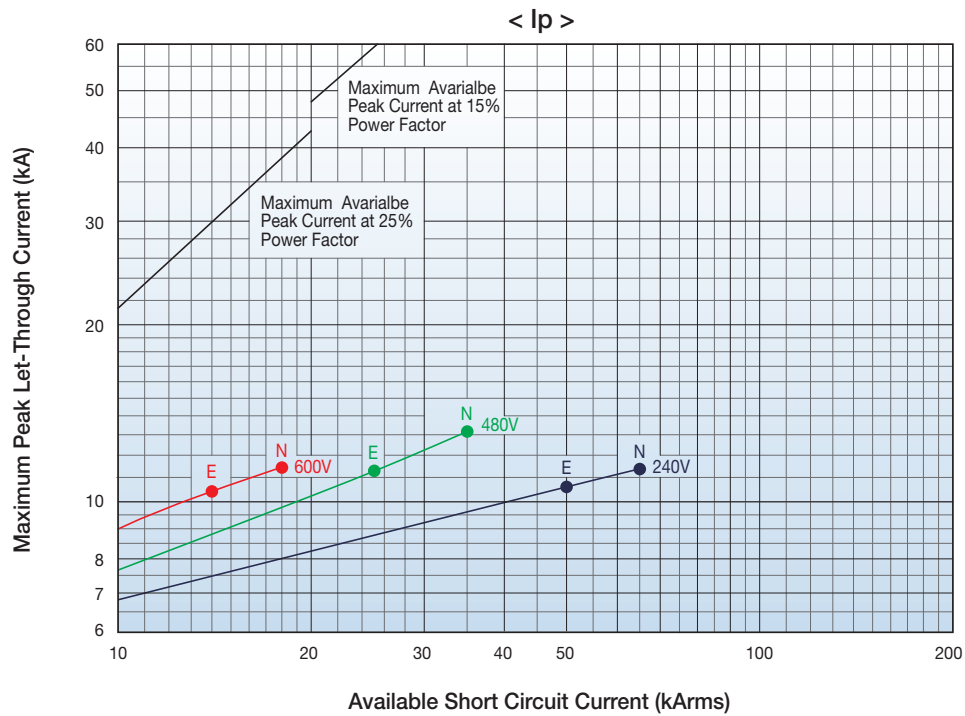

## UTS150 CHARACTERISTIC

Based on typical values obtained throughout the circuit breaker development and UL test programs.

### LET-THROUGH ENERGY $I^2t$ (240V, 480V AND 600V)

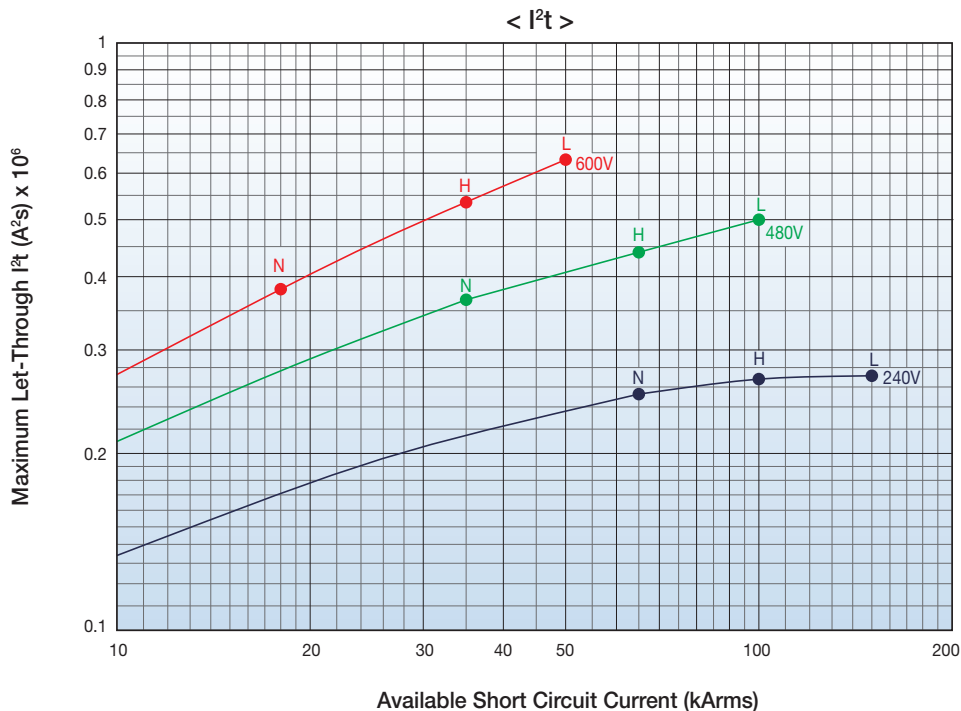

### PEAK LET-THROUGH CURRENT $I_p$ (240V, 480V AND 600V)

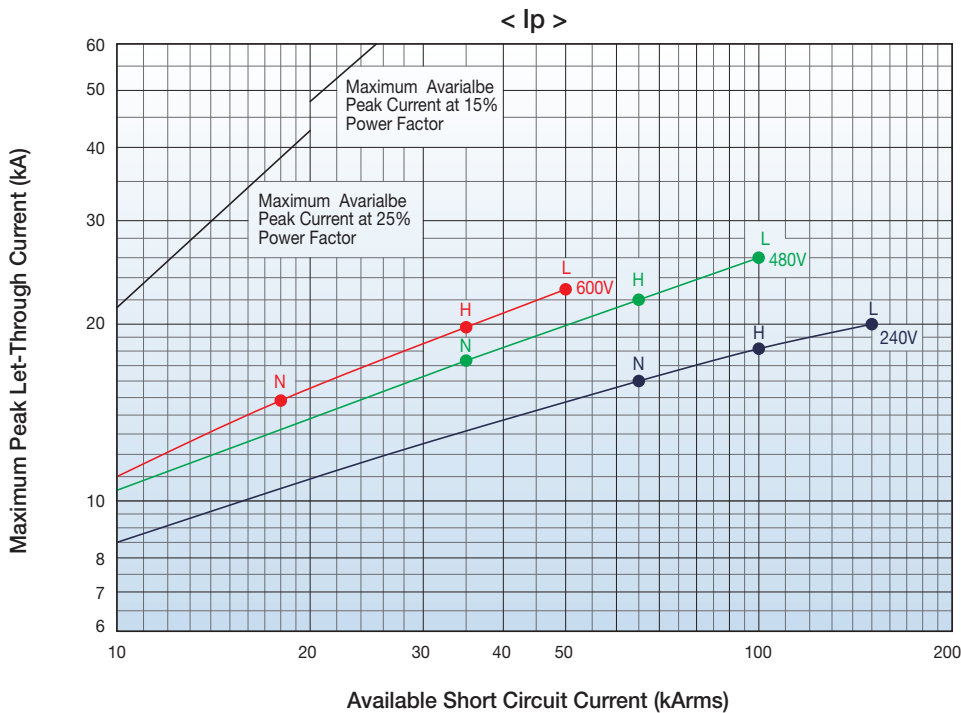

## UTS250 CHARACTERISTIC

Based on typical values obtained throughout the circuit breaker development and UL test programs.

### LET-THROUGH ENERGY $I^2t$ (240V, 480V AND 600V)

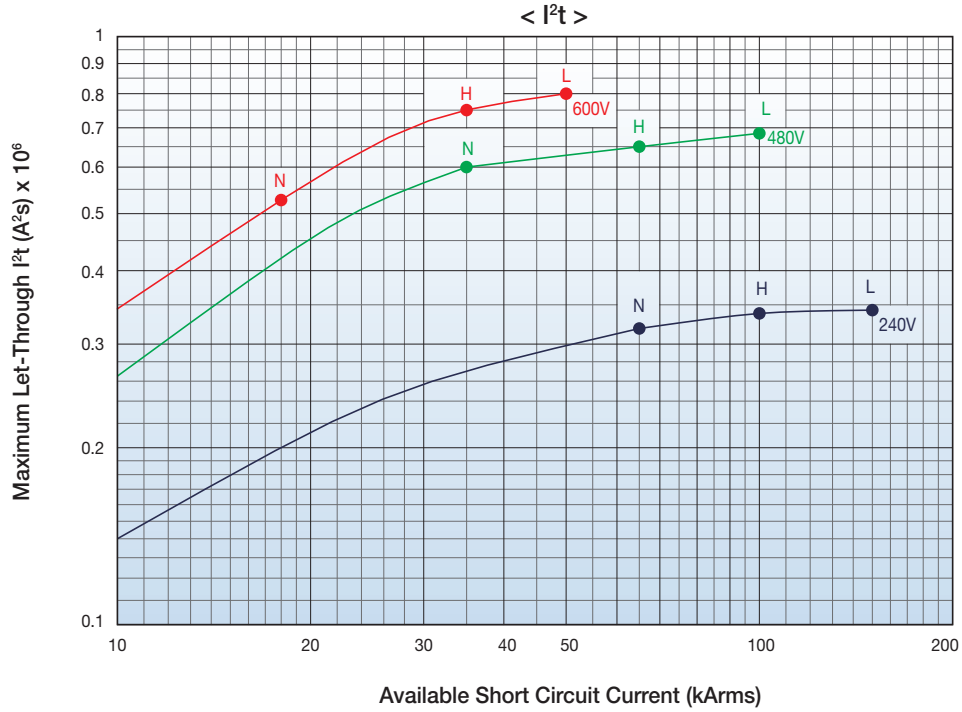

### PEAK LET-THROUGH CURRENT $I_p$ (240V, 480V AND 600V)

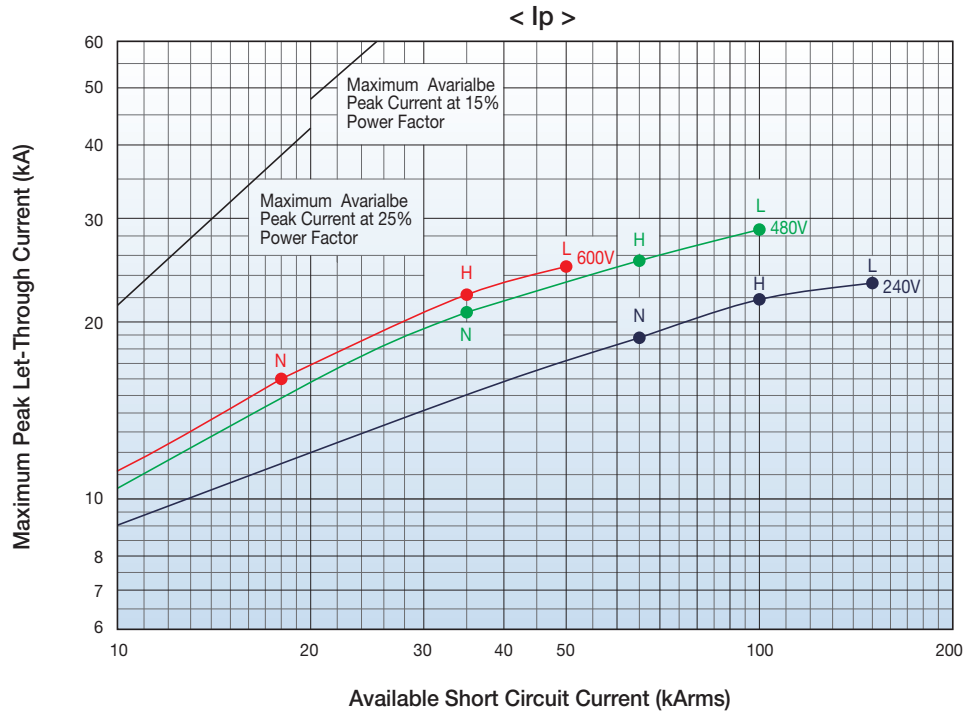



## UTS400 CHARACTERISTIC

Based on typical values obtained throughout the circuit breaker development and UL test programs.

### LET-THROUGH ENERGY $I^2t$ (240V, 480V AND 600V)

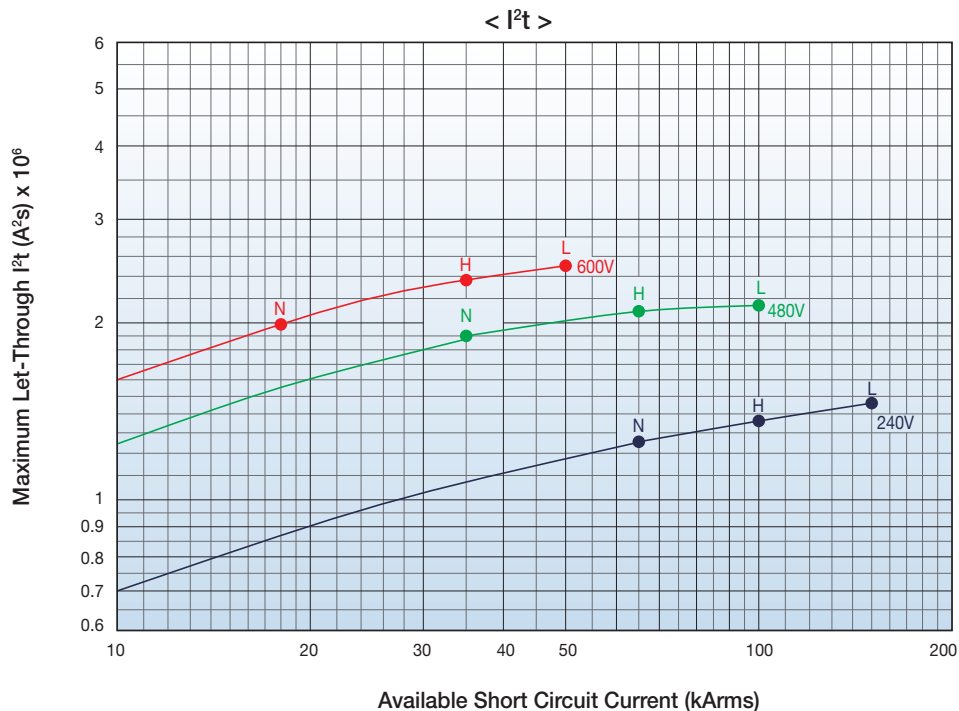

### PEAK LET-THROUGH CURRENT $I_p$ (240V, 480V AND 600V)

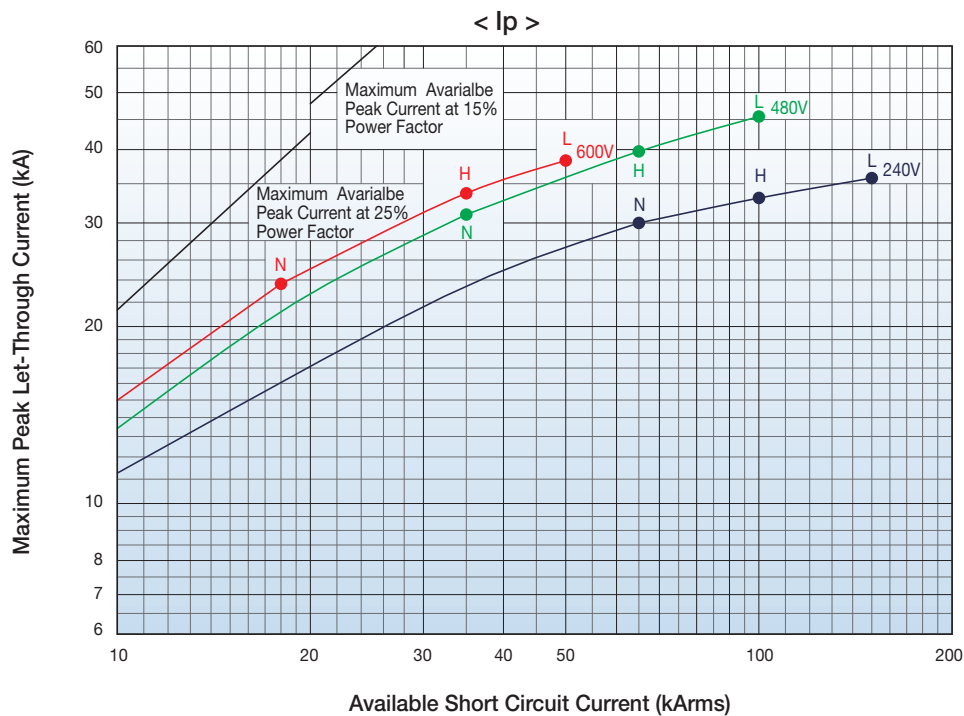

## UTS600 CHARACTERISTIC

Based on typical values obtained throughout the circuit breaker development and UL test programs.

### LET-THROUGH ENERGY $I^2t$ (240V, 480V AND 600V)

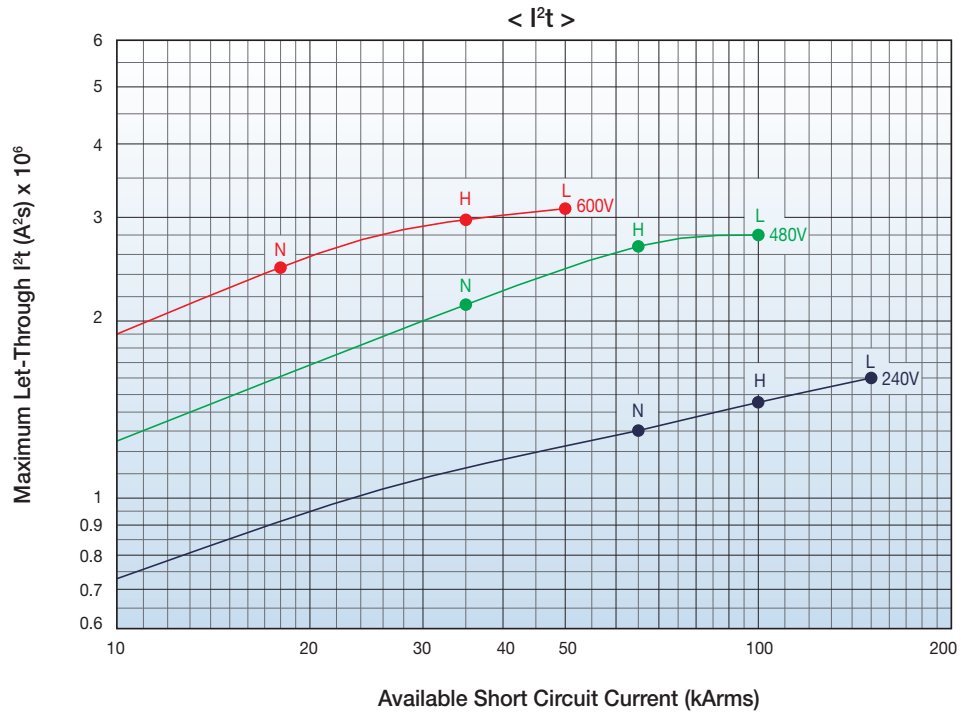

### PEAK LET-THROUGH CURRENT $I_p$ (240V, 480V AND 600V)

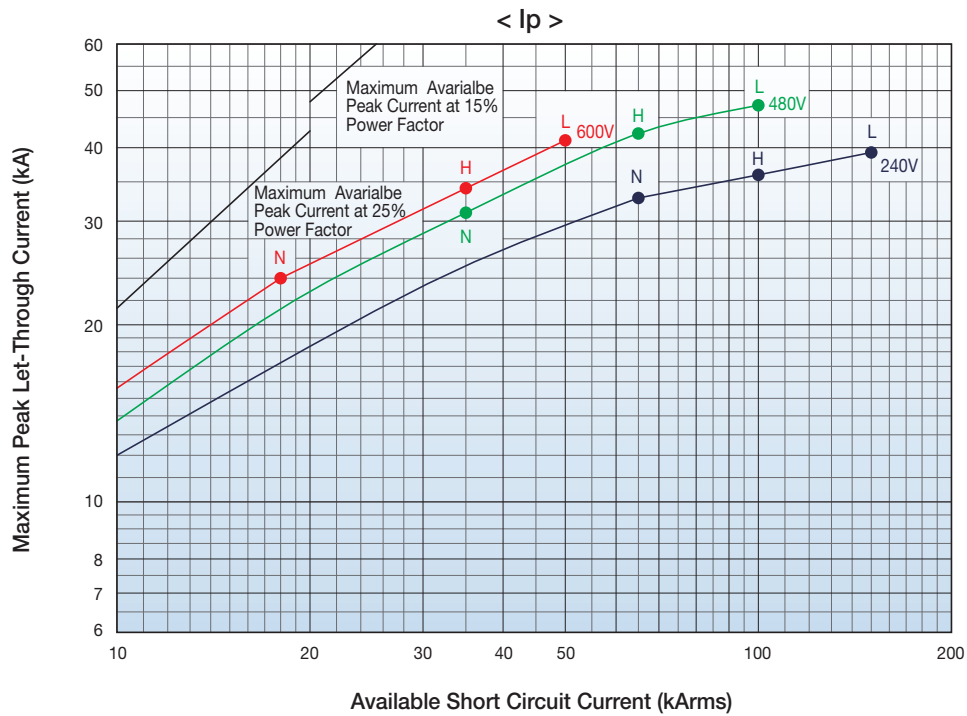

## UTS800 CHARACTERISTIC

Based on typical values obtained throughout the circuit breaker development and UL test programs.

### LET-THROUGH ENERGY $I^2t$ (240V, 480V AND 600V)

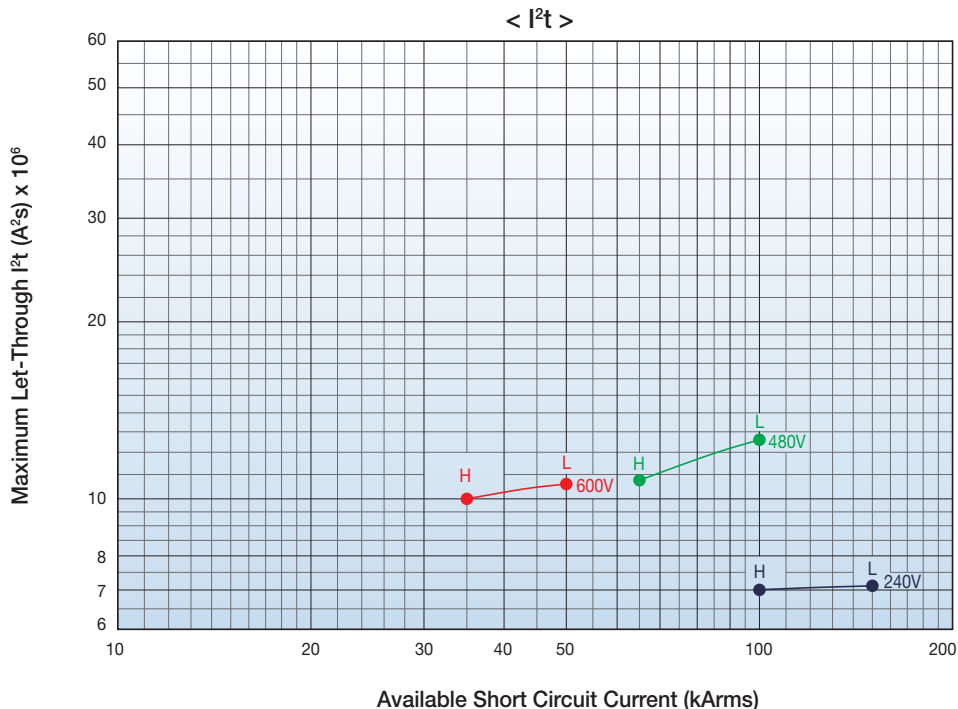

### PEAK LET-THROUGH CURRENT $I_p$ (240V, 480V AND 600V)

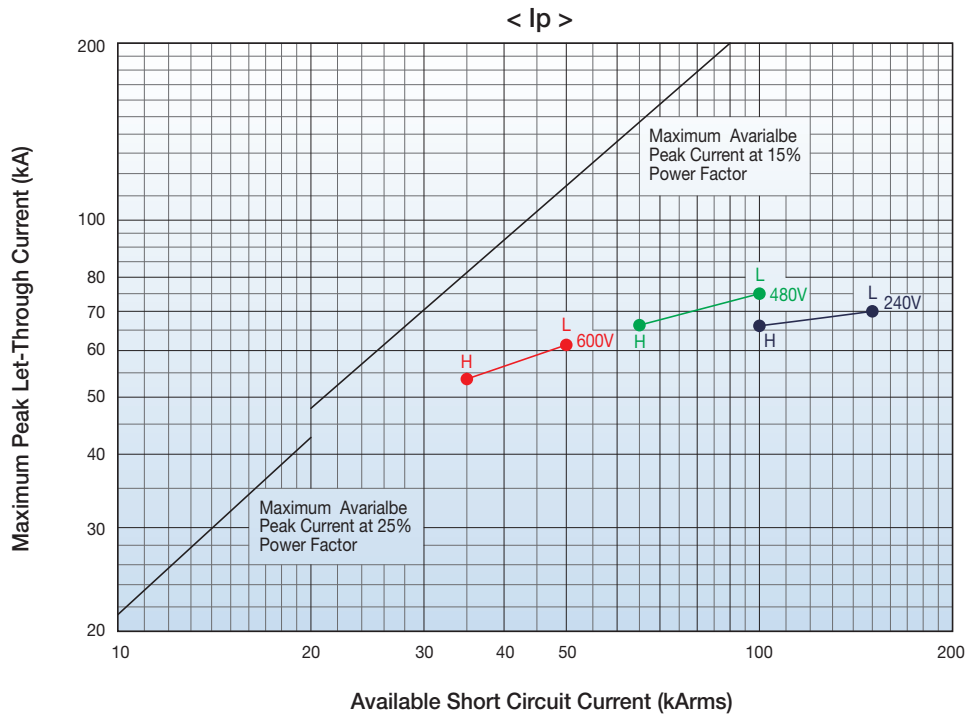

## UTS1200 CHARACTERISTIC

Based on typical values obtained throughout the circuit breaker development and UL test programs.

### LET-THROUGH ENERGY $I^2t$ (240V, 480V AND 600V)

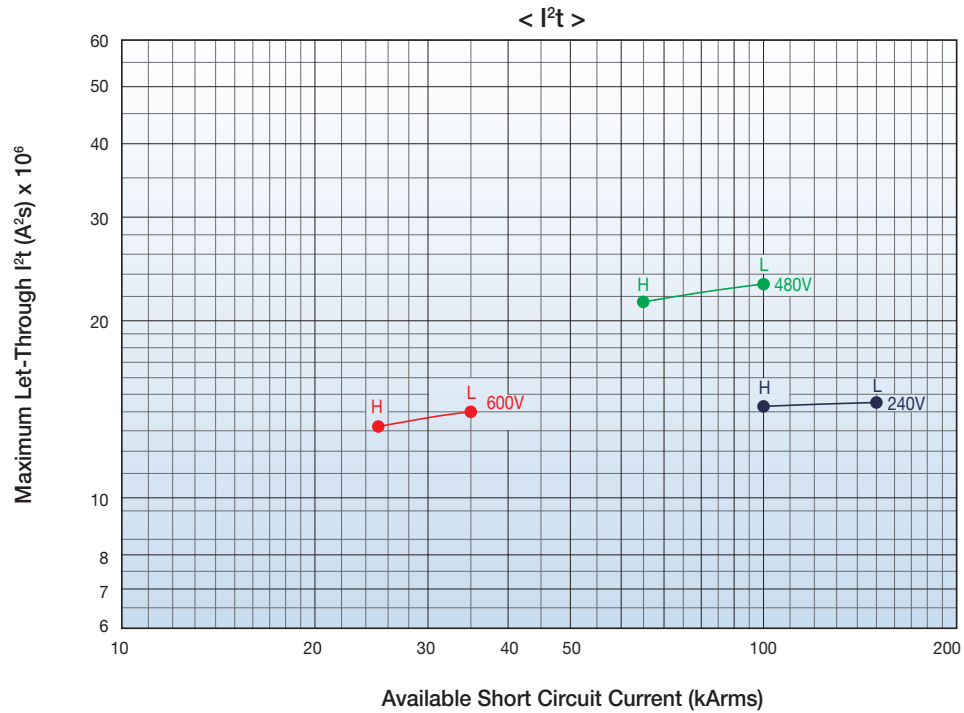

### PEAK LET-THROUGH CURRENT $I_p$ (240V, 480V AND 600V)

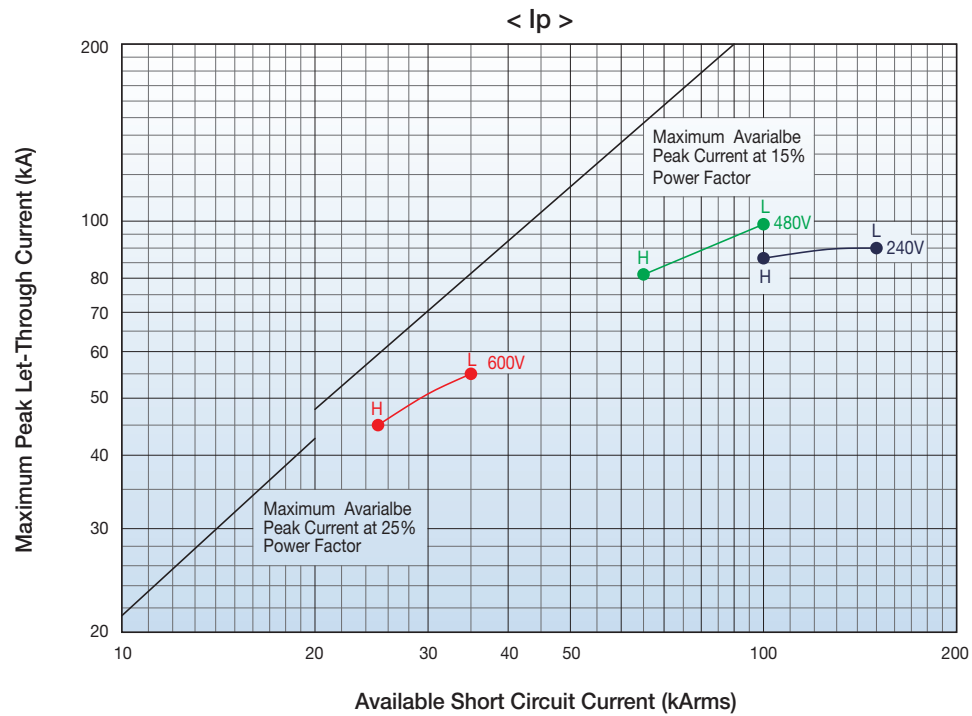

## DIMENSIONS

UTE100	152 page
UTS150	157 page
UTS250	157 page
UTS400	164 page
UTS600	164 page
UTS800	169 page
UTS1200	169 page

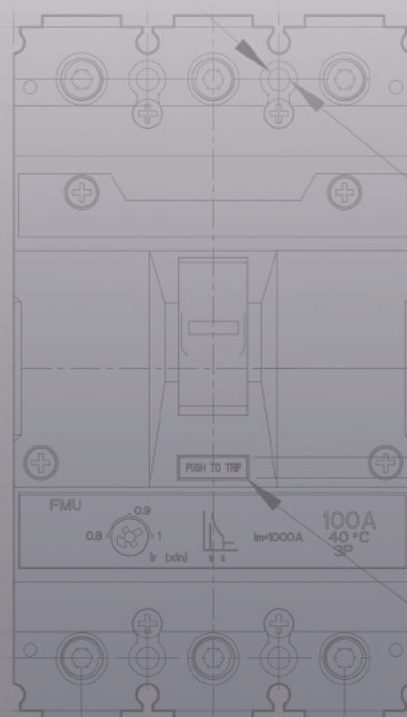

# DIMENSIONS UTE100 CIRCUIT BREAKERS

## UTE100 1P/2P Circuit Breaker [Lug type]

Dimension: inch[mm]

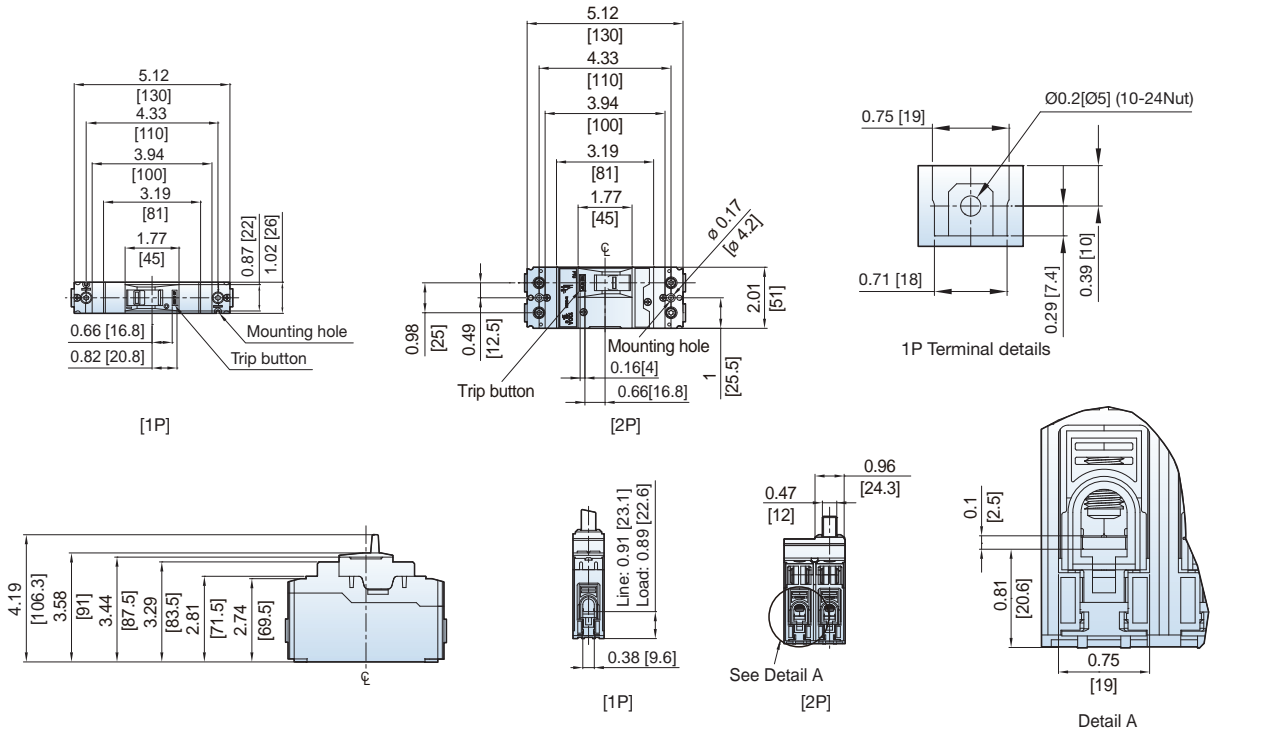

## UTE100 1P/2P Circuit Breaker [Bolt-on Type]

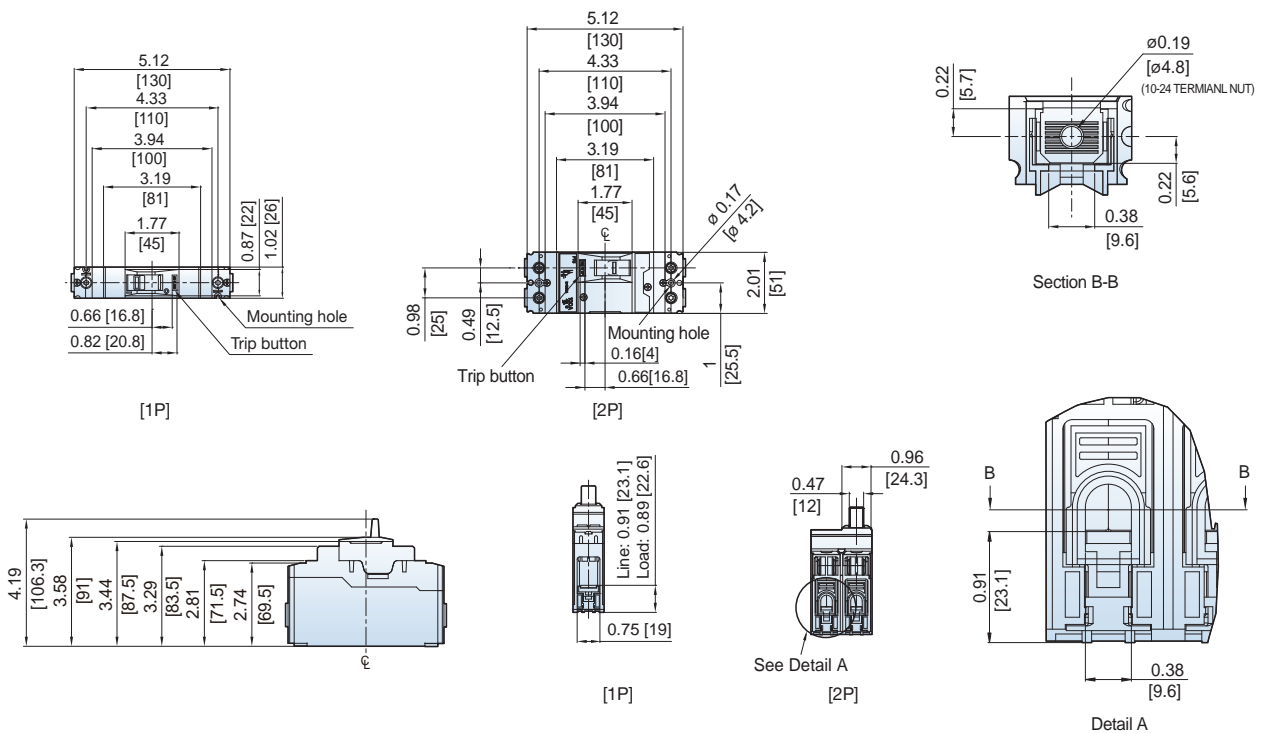

UTE100 3P Circuit Breaker [Lug type]

Dimension: inch[mm]

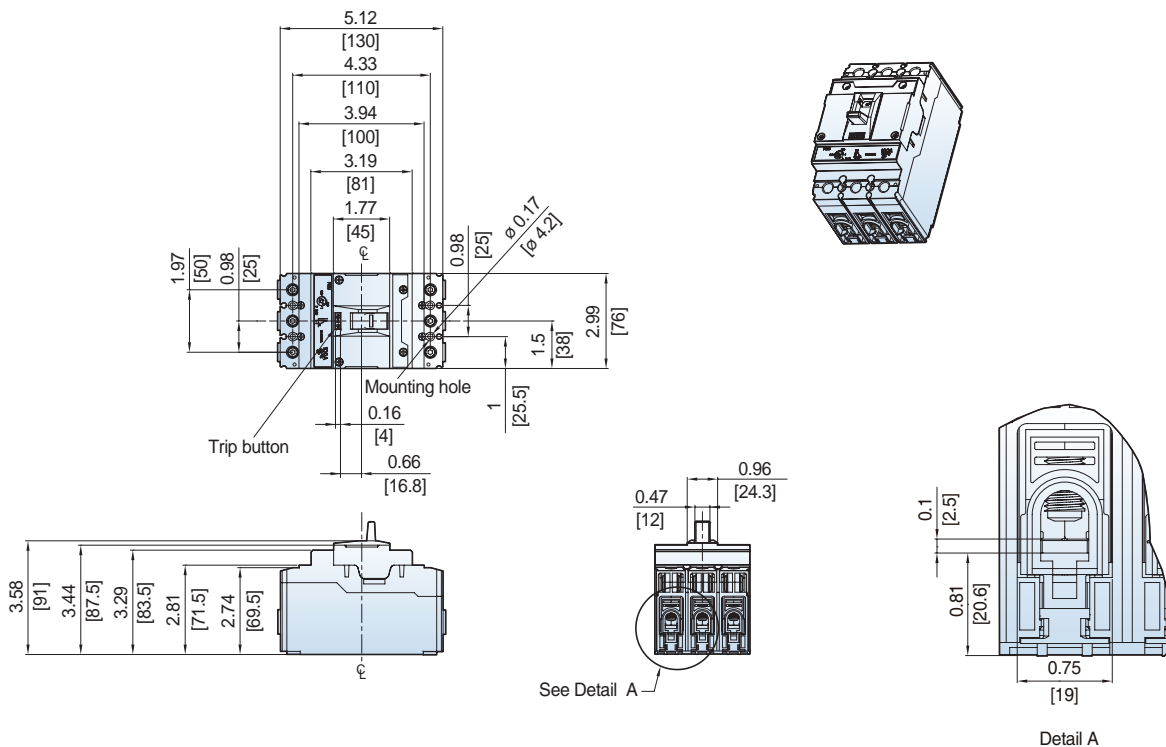

UTE100 3P Circuit Breaker [Bolt-on Type]

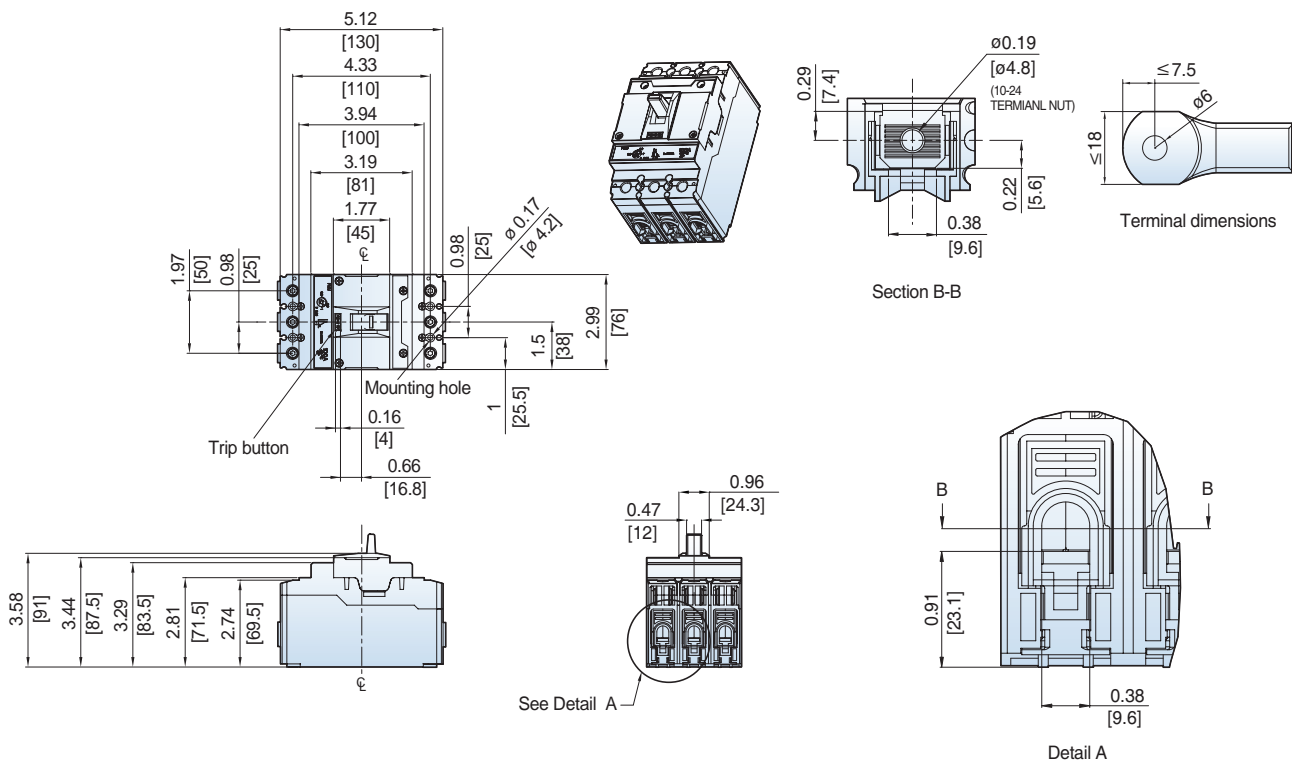

## DIMENSIONS UTE100 CIRCUIT BREAKERS

### UTE100 Circuit Breakers Mounting

Dimension: inch[mm]

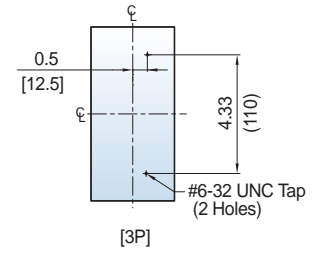
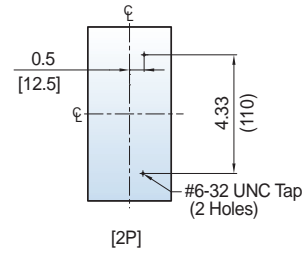
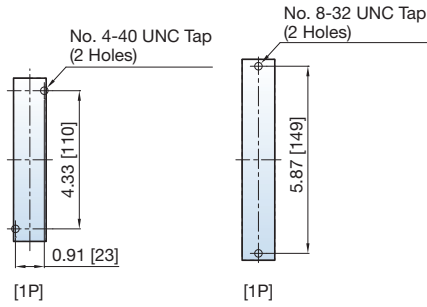

### UTE100 Circuit Breakers Door Cutouts

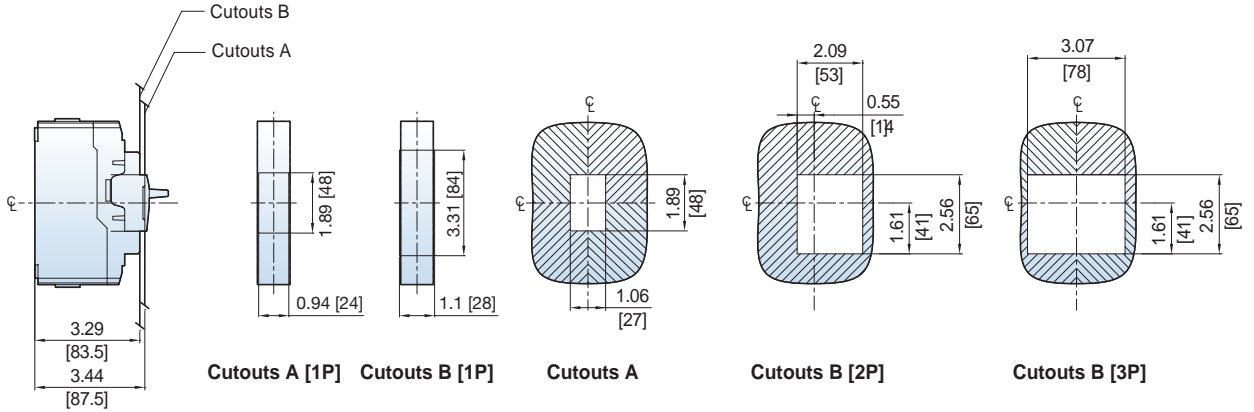

### UTE100 Directly Mounted Rotary Operating Handle [DH-0]

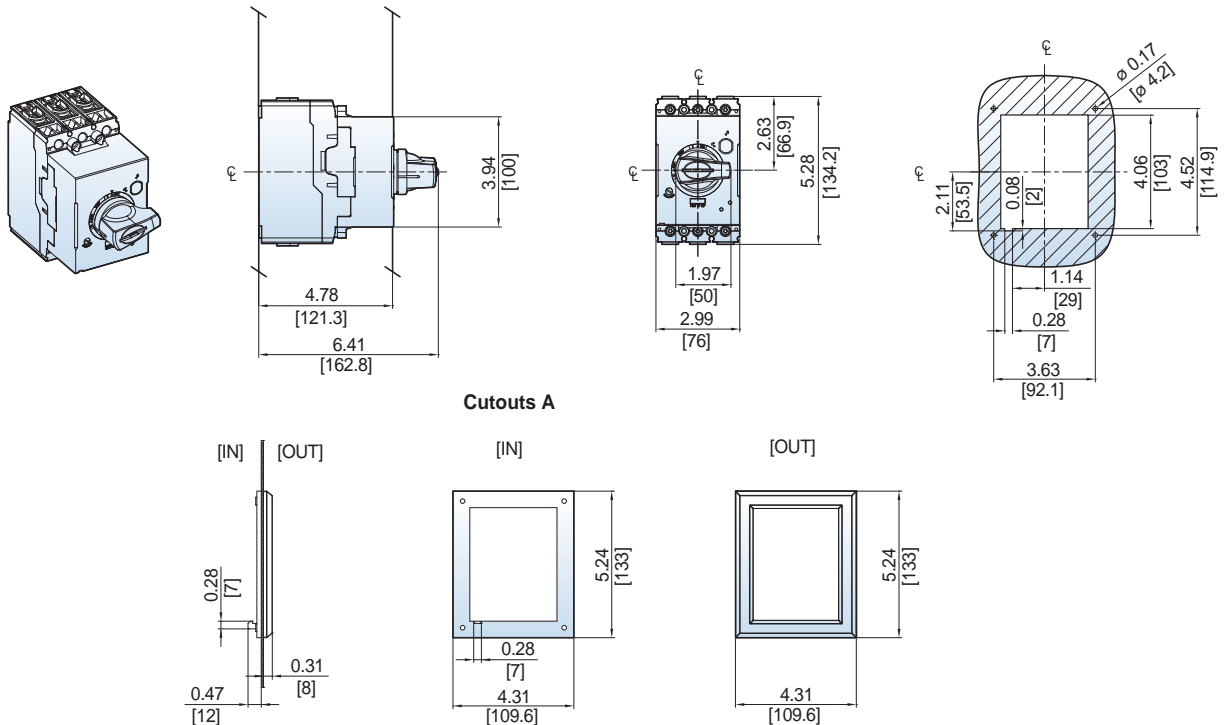



**UTE100 Door-Mounted Rotary Operating Handle [REH-0]**

Dimension: inch[mm]

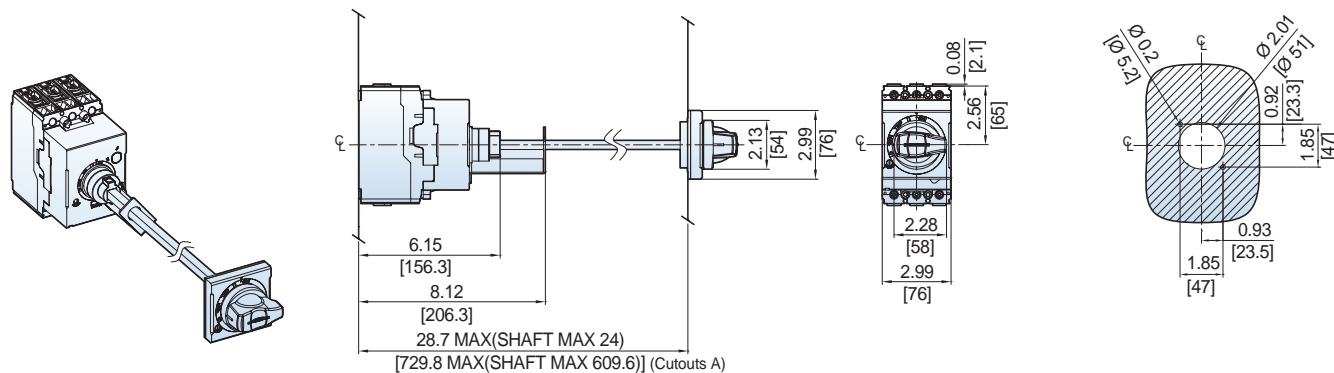

**UTE100 Door-Mounted Rotary Operating Handle [REH-0C]**

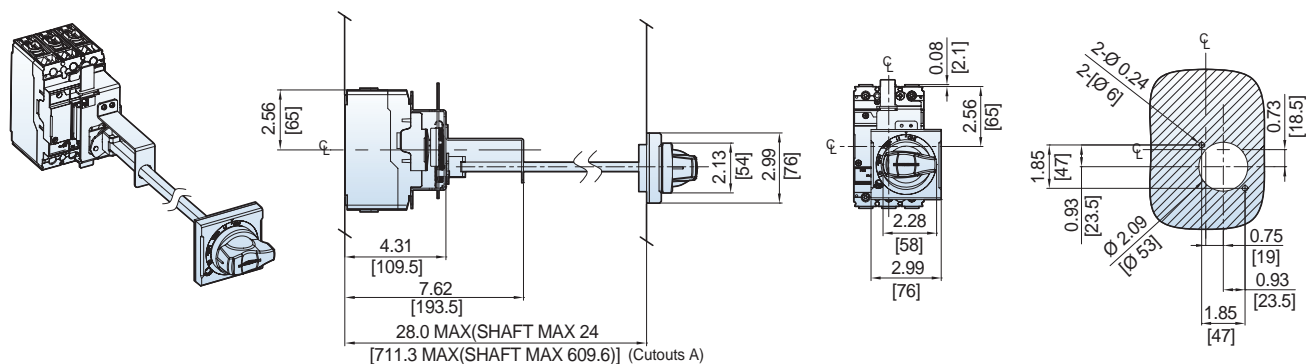

**UTE100 NEMA Door-Mounted Rotary Operating Handle [EHU-0, EHV-0, EHX-0]**

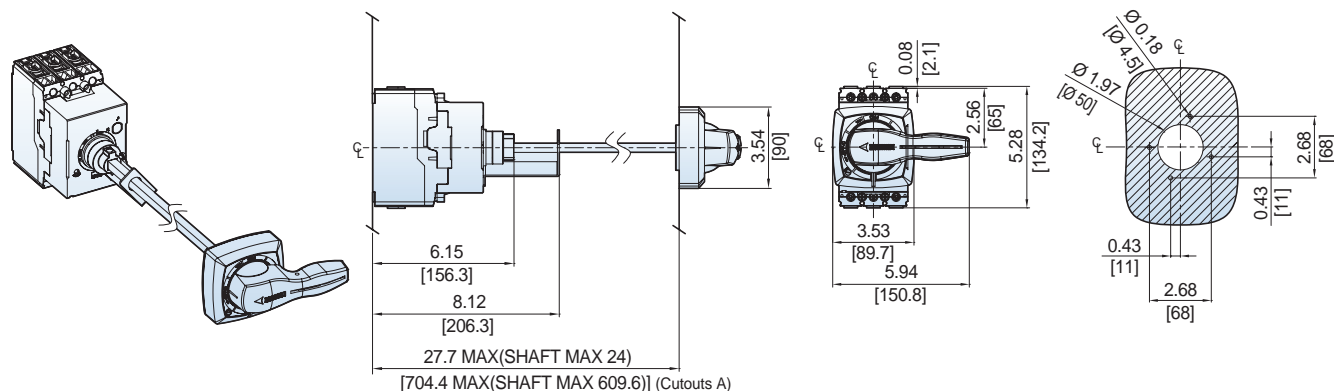

## DIMENSIONS UTE100 CIRCUIT BREAKERS

### UTE100 NEMA Door-Mounted Rotary Operating Handle [EHU-0C, EHX-0C]

Dimension: inch[mm]

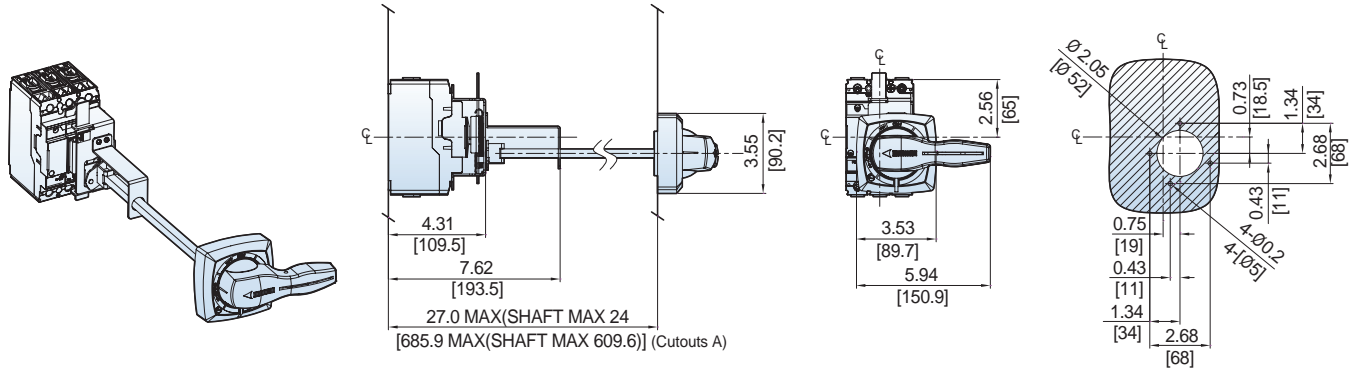

### UTE100 Flange-Mounted Cable Operating Handle [COM-0 + FHU, X-S + Cable]

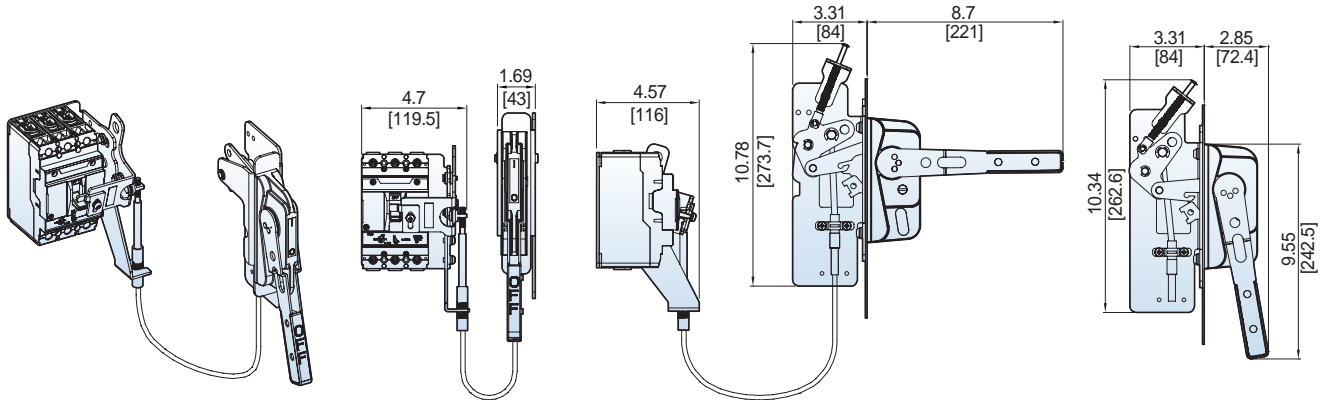

### UTE100 Flange-Mounted Variable-Depth Operating Handle [VDM-0 + FHU, X-S]

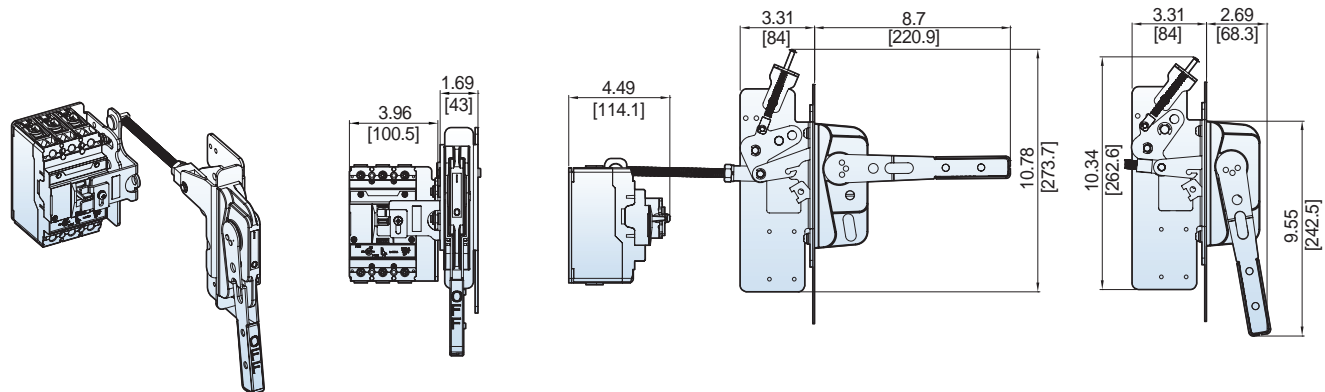

## DIMENSIONS UTS150/250 CIRCUIT BREAKERS

### UTS150 3P Circuit Breaker [Lug type]

Dimension: inch[mm]

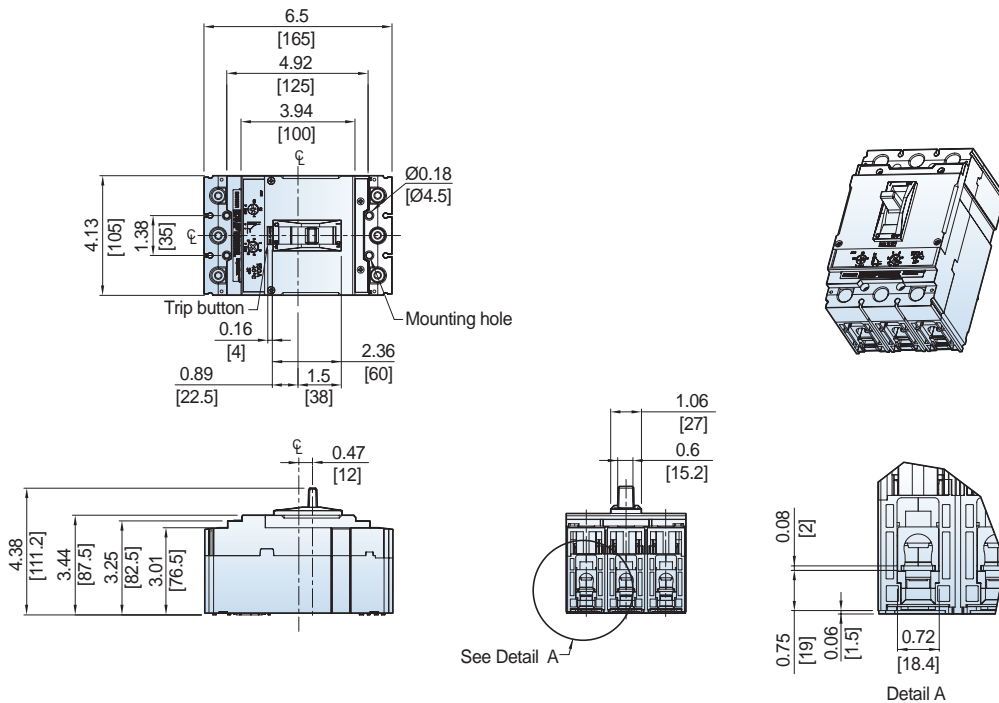

### UTS250 3P Circuit Breaker [Lug type]

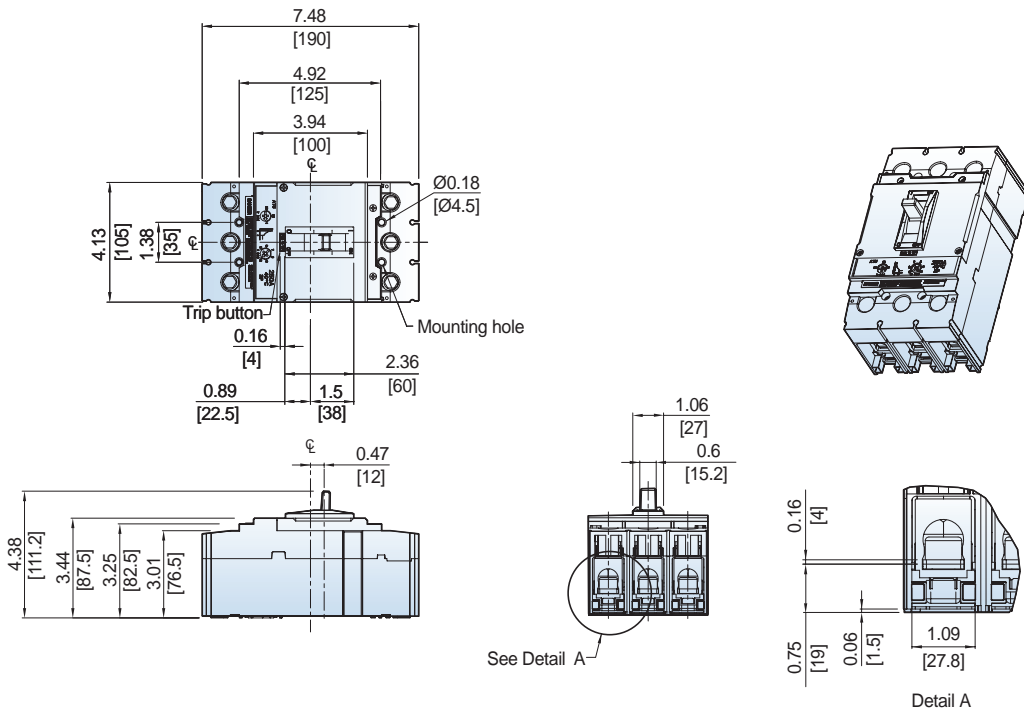

## DIMENSIONS UTS150/250 CIRCUIT BREAKERS

### UTS150 3P Circuit Breaker [Bolt-on Type]

Dimension: inch[mm]

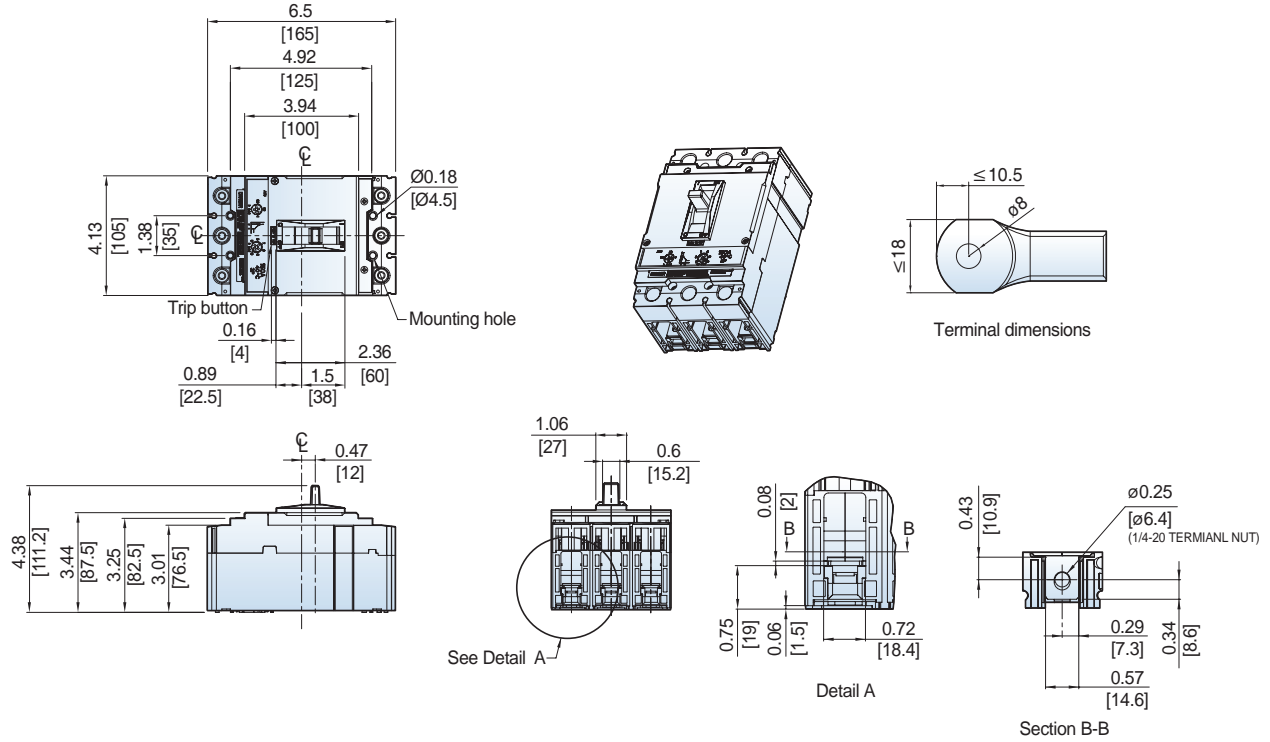

### UTS250 3P Circuit Breaker [Bolt-on Type]

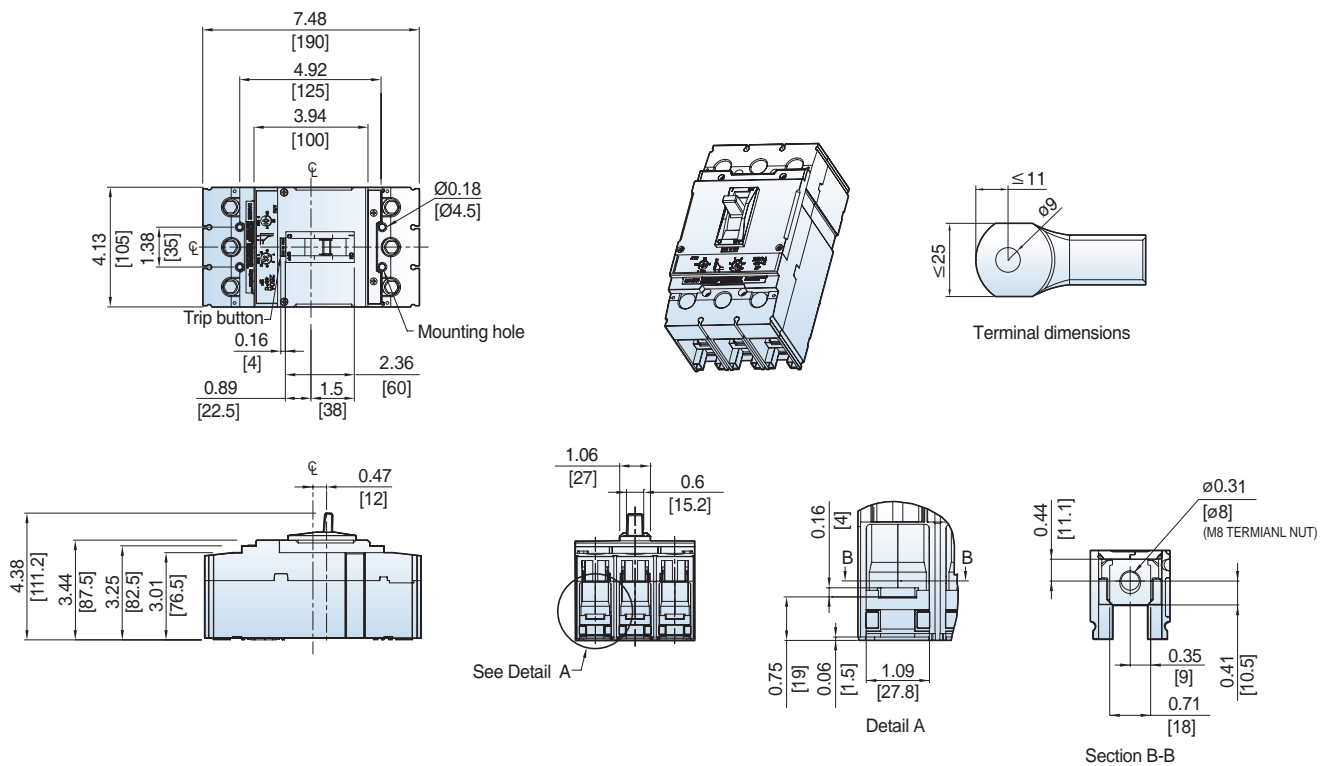

UTS150/250 Circuit Breaker & Accessory Mounting

Dimension: inch[mm]

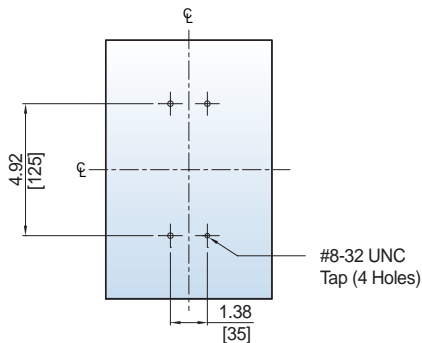

UTS150/250 Circuit Breaker Door Cutouts

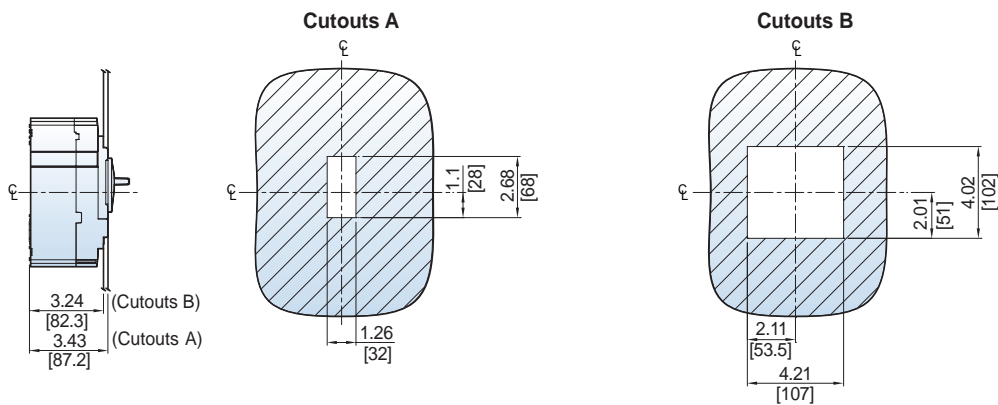

UTS150/250 Directly Mounted Rotary Operating Handle [DH-2]

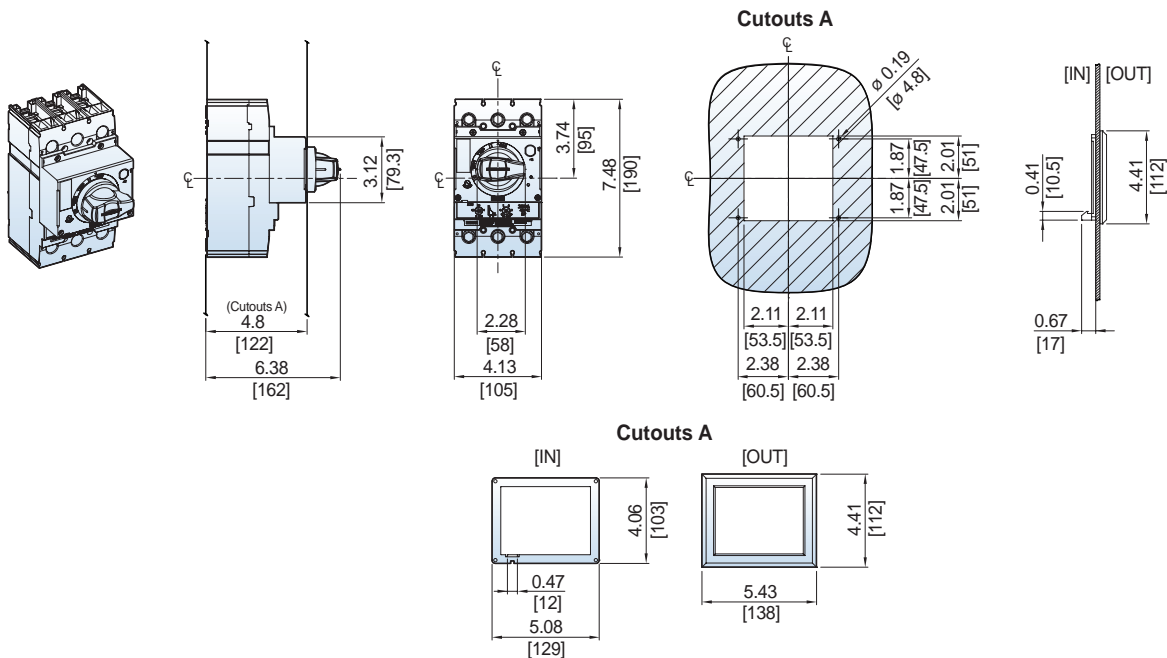

## DIMENSIONS UTS150/250 CIRCUIT BREAKERS

### UTS150/250 Door-Mounted Rotary Operating Handle [REH-2]

Dimension: inch[mm]

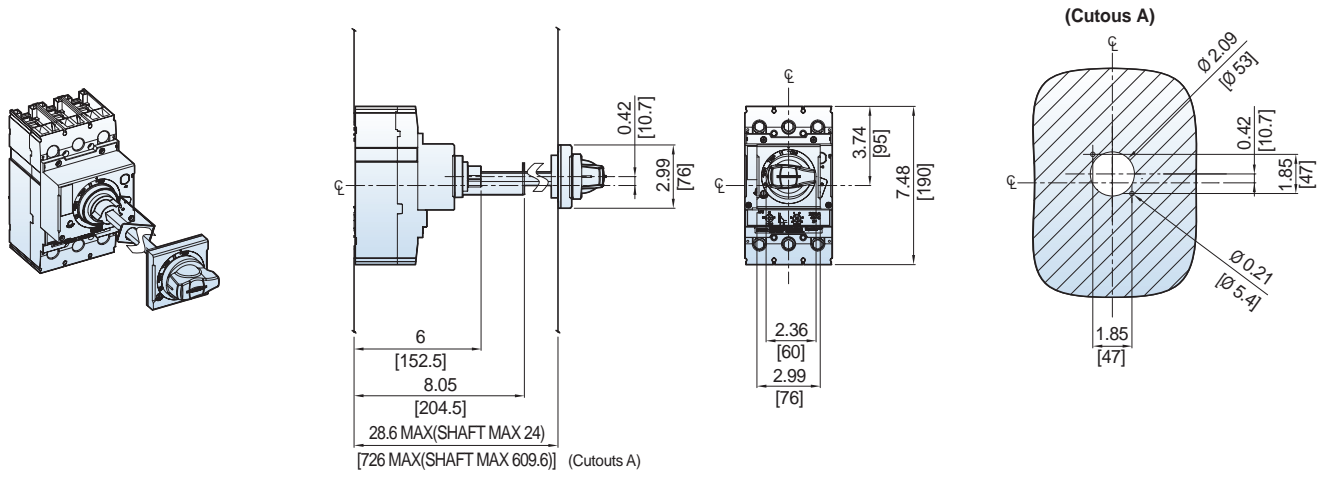

### UTS150/250 NEMA Door-Mounted Rotary Operating Handle [EHU-2, EHV-2, EHX-2]

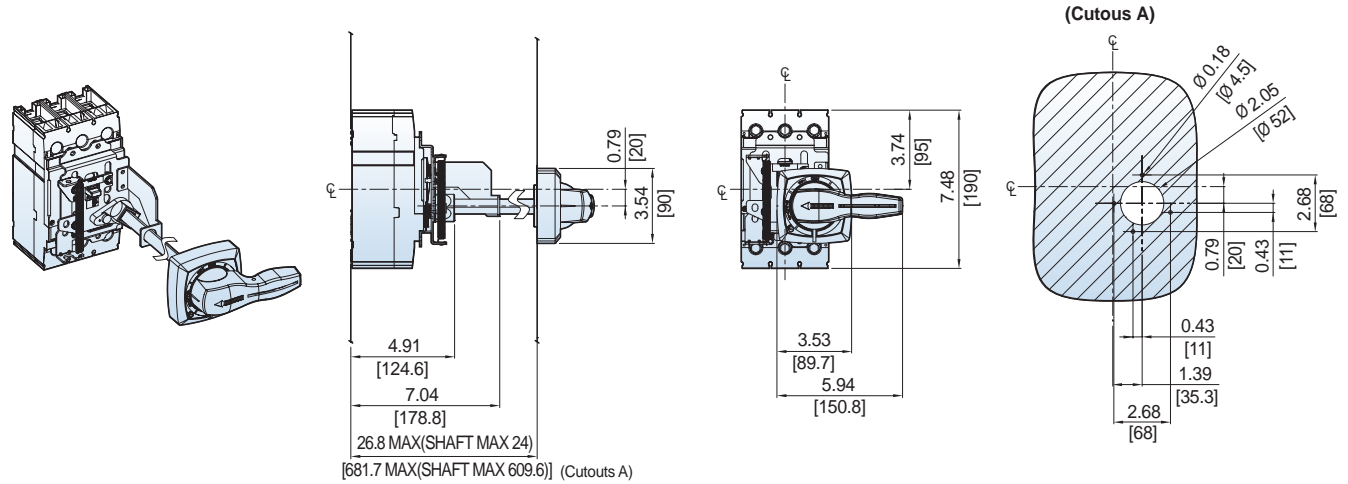

### UTS150/250 Flange-Mounted Cable Operating Handle [FHU-2, FHX-2 Type]

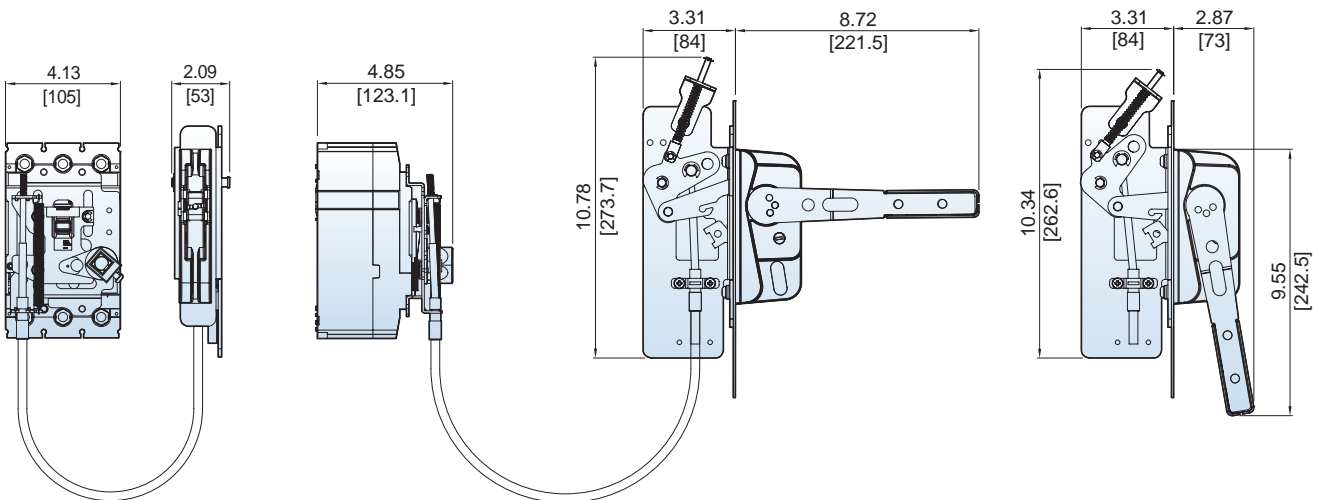

**UTS150/250 Flange-Mounted Cable Operating Handle [COM-2 + FHU, X-S + Cable]**

Dimension: inch[mm]

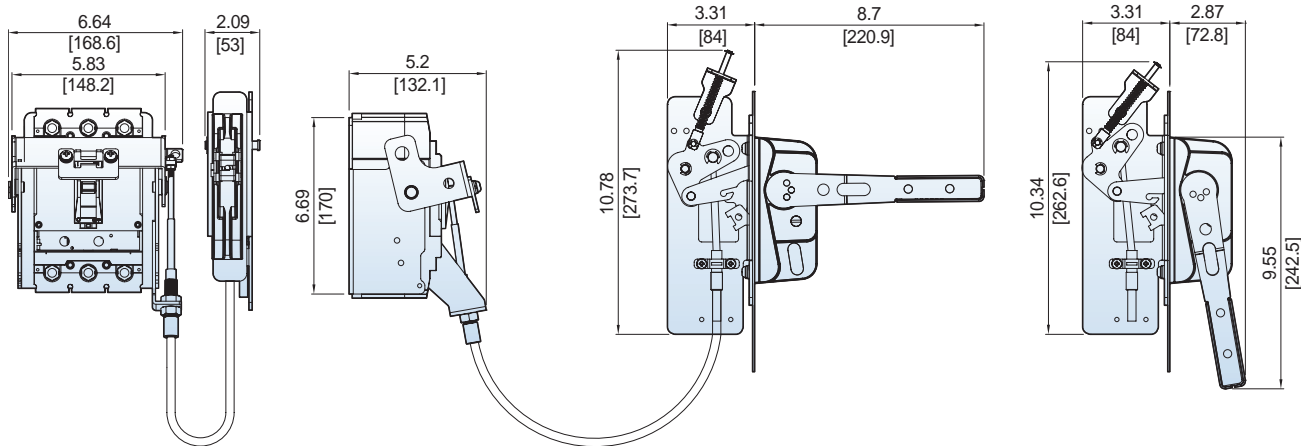

**UTS150/250 Flange-Mounted Variable-Depth Operating Handle [VDM-2 + FHU, X-S]**

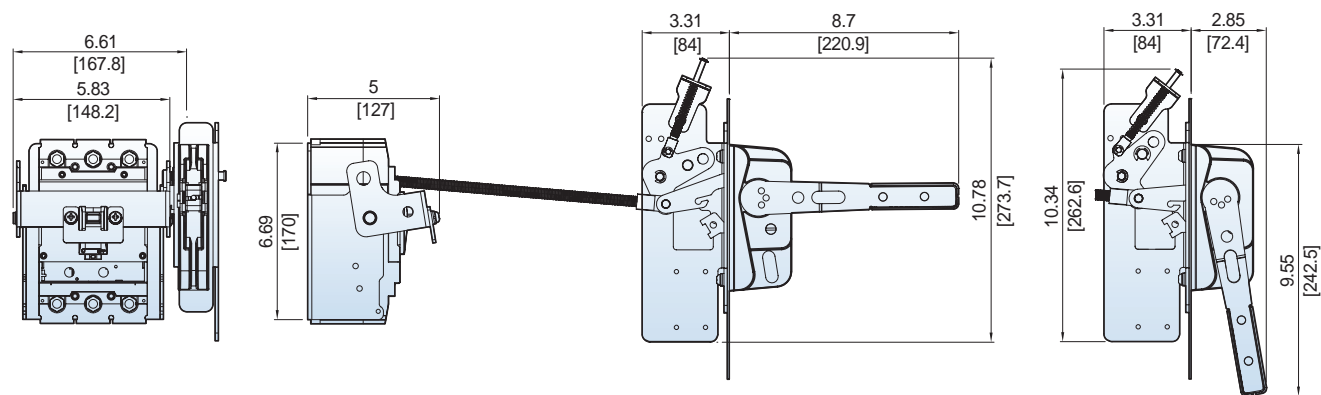

# DIMENSIONS UTS250(RCD) CIRCUIT BREAKERS

## RTU23U 3P [Lug type]

Dimension: inch[mm]

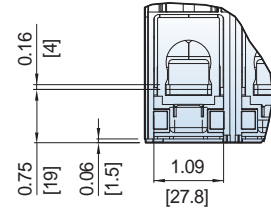
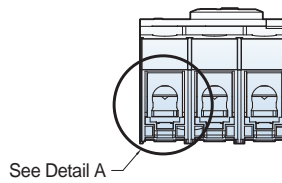
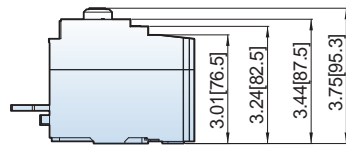
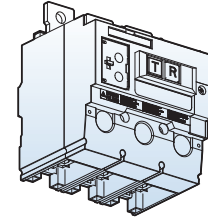
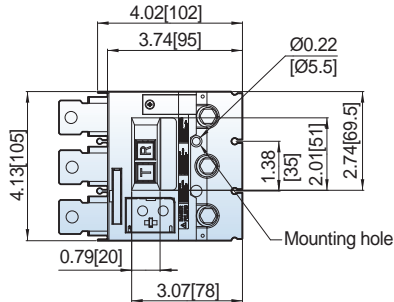

Detail A

## RTU23U 3P [Bolt-on type]

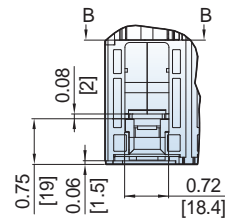
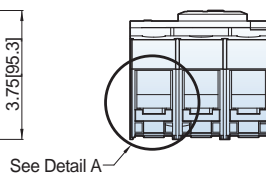
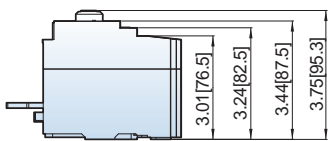
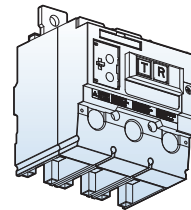
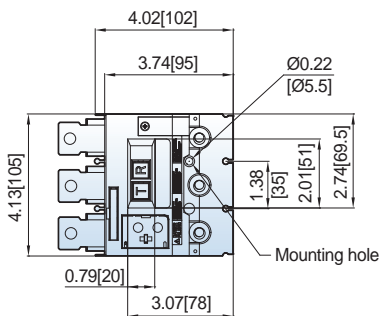

Detail A

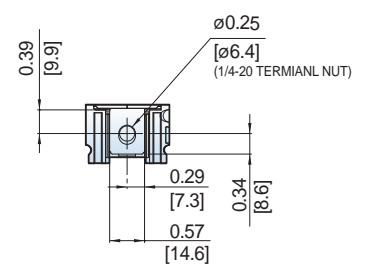

Section B-B



RTU23U Accessory Mounting

Dimension: inch[mm]

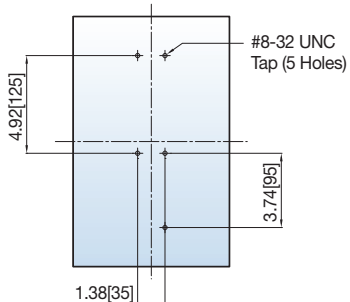

RTU23U Door Cutouts

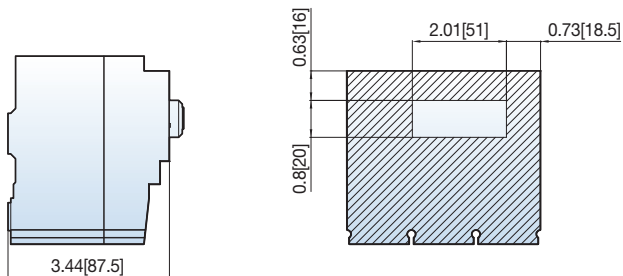

UTS250+RTU23U 3P

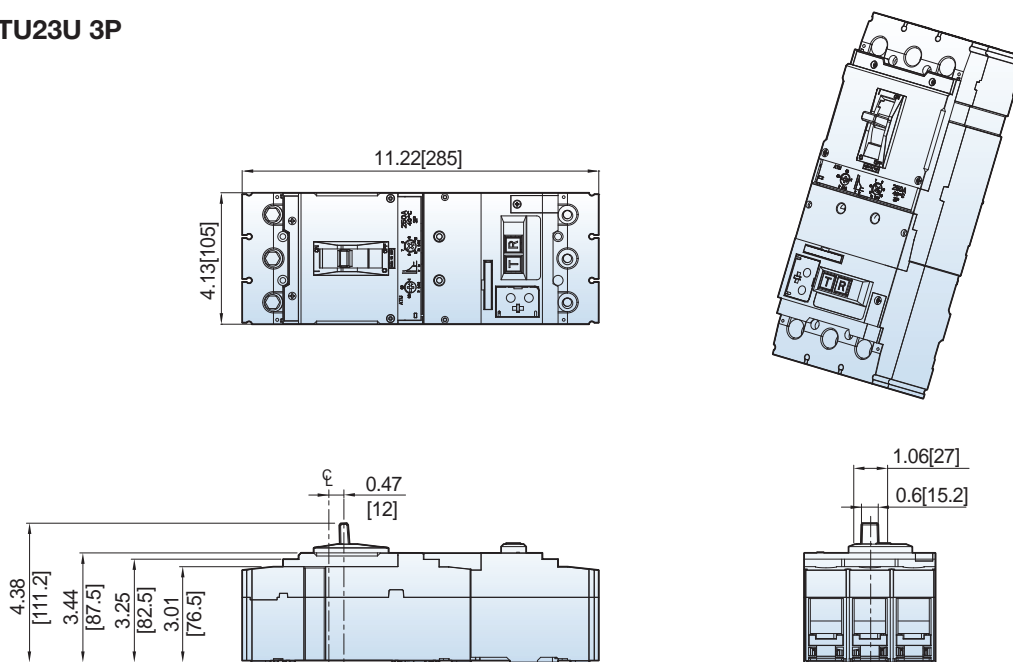

## DIMENSIONS UTS400/600 CIRCUIT BREAKERS

### UTS400 3P Circuit Breaker [Lug type]

Dimension: inch[mm]

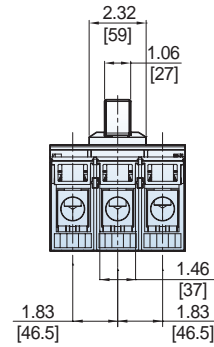
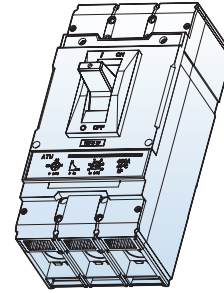
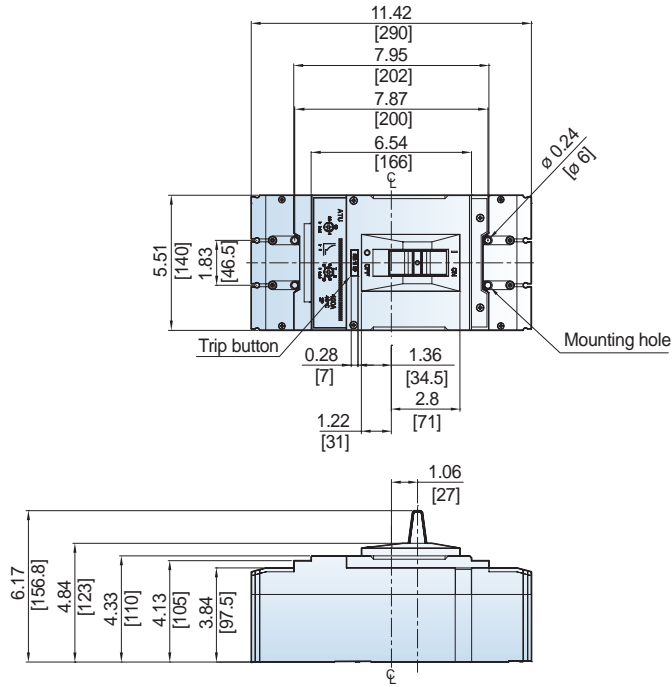

### UTS600 3P Circuit Breaker [Lug type]

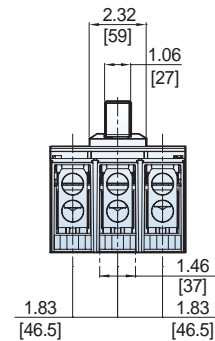
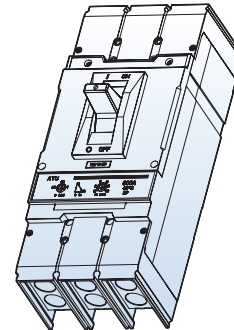
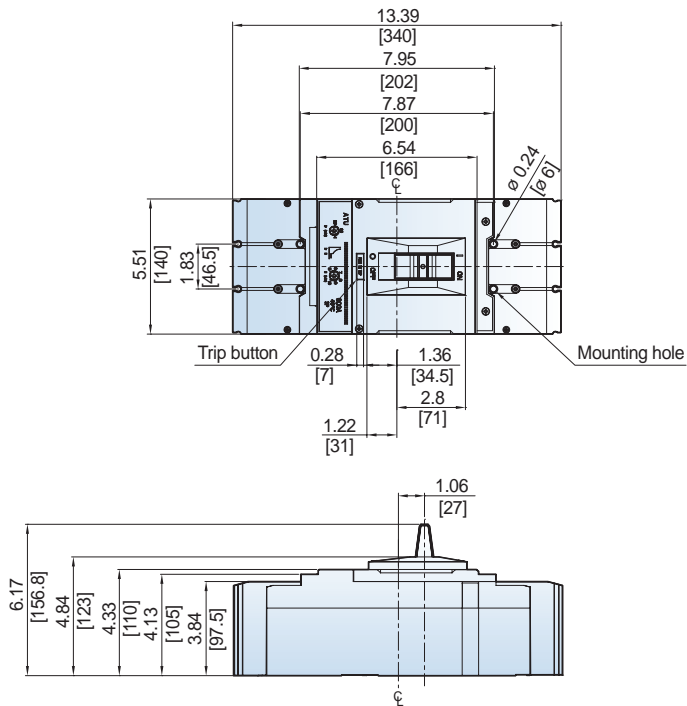

UTS400 3P Circuit Breaker [Bolt-on Type]

Dimension: inch[mm]

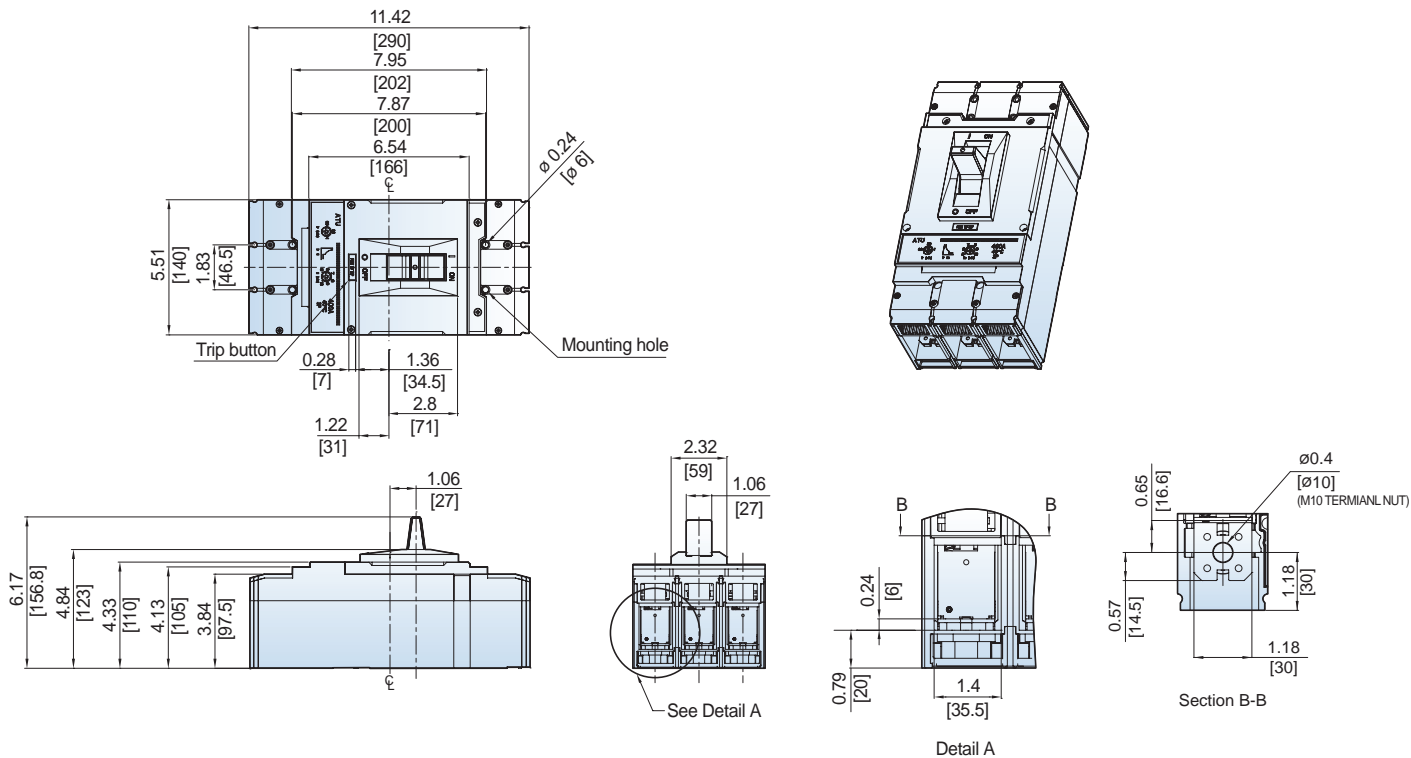

UTS600 3P Circuit Breaker [Bolt-on Type]

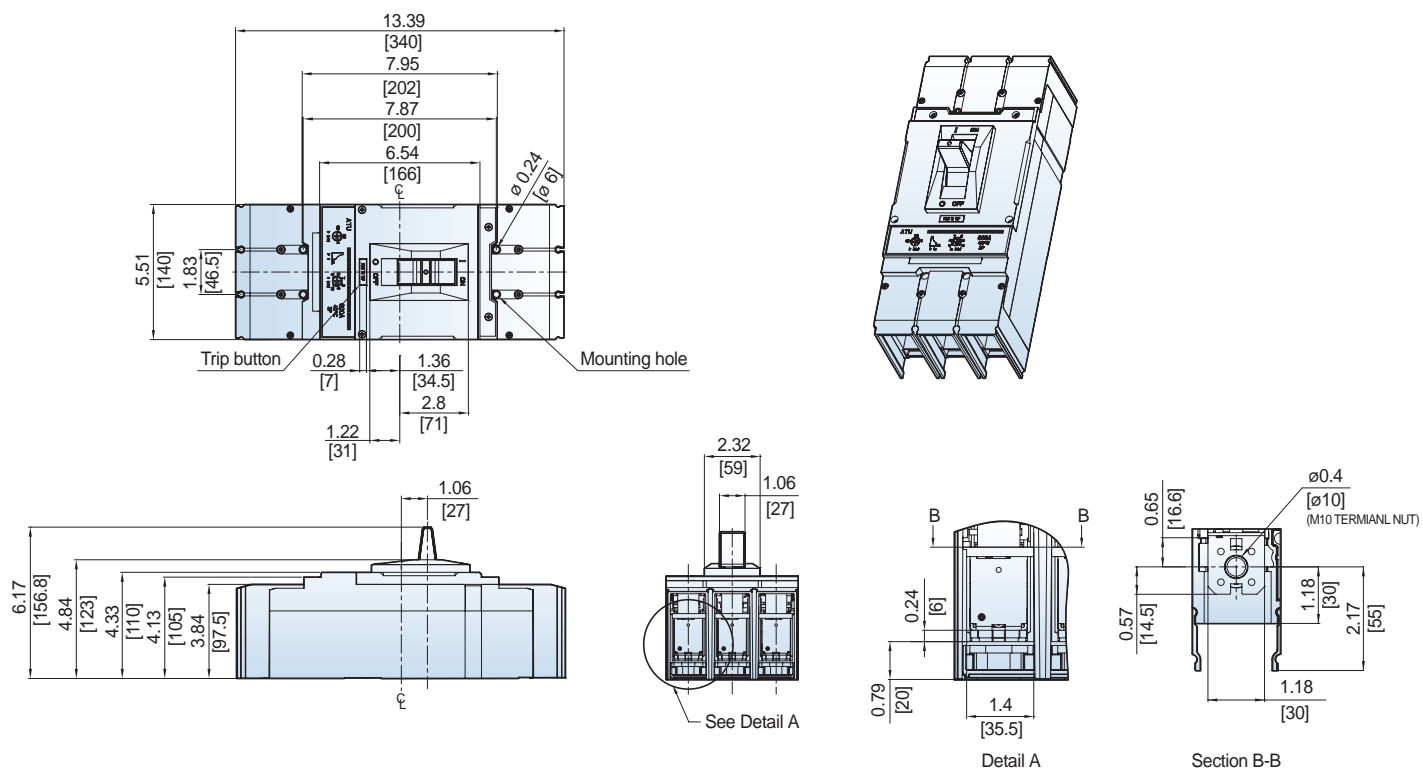

## DIMENSIONS UTS400/600 CIRCUIT BREAKERS

### UTS400/600 Circuit Breaker Mounting

Dimension: inch[mm]

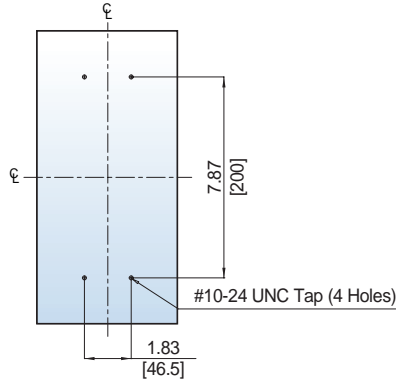

### UTS400/600 Circuit Breaker Door Cutouts

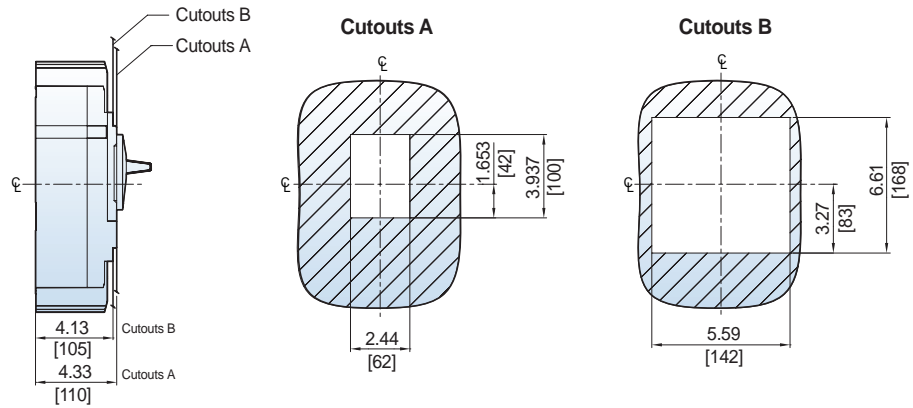

### UTS400/600 Directly Mounted Rotary Operating Handle [DH-3]

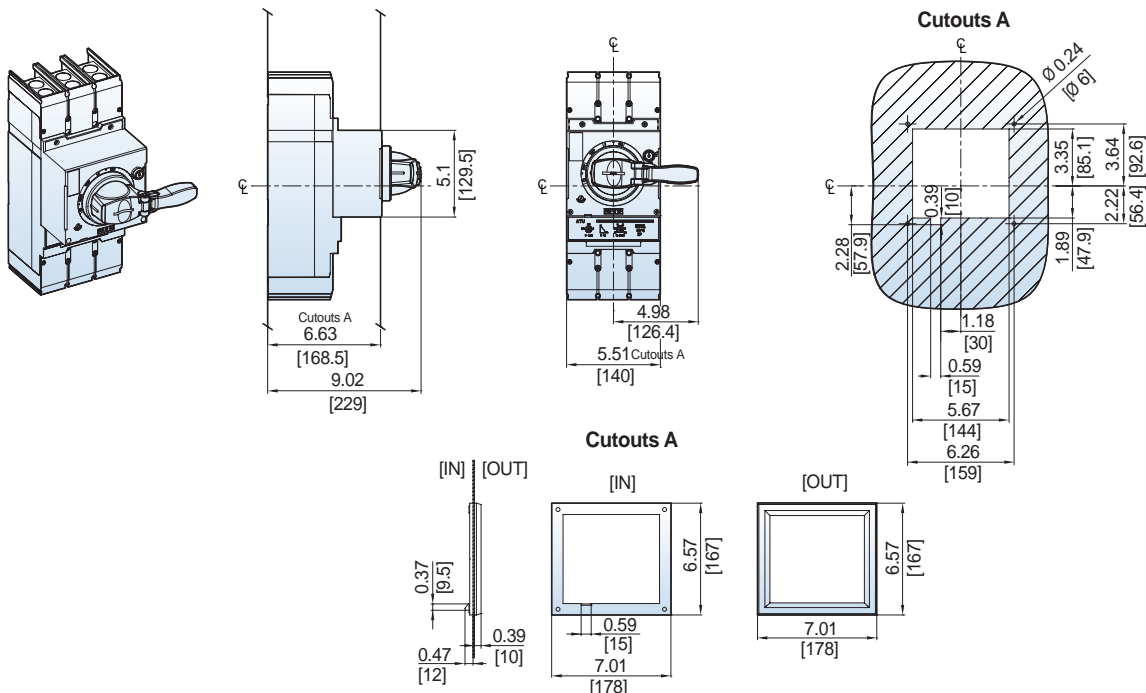

**UTS400/600 Door-Mounted Rotary Operating Handle [REH-3]**

Dimension: inch[mm]

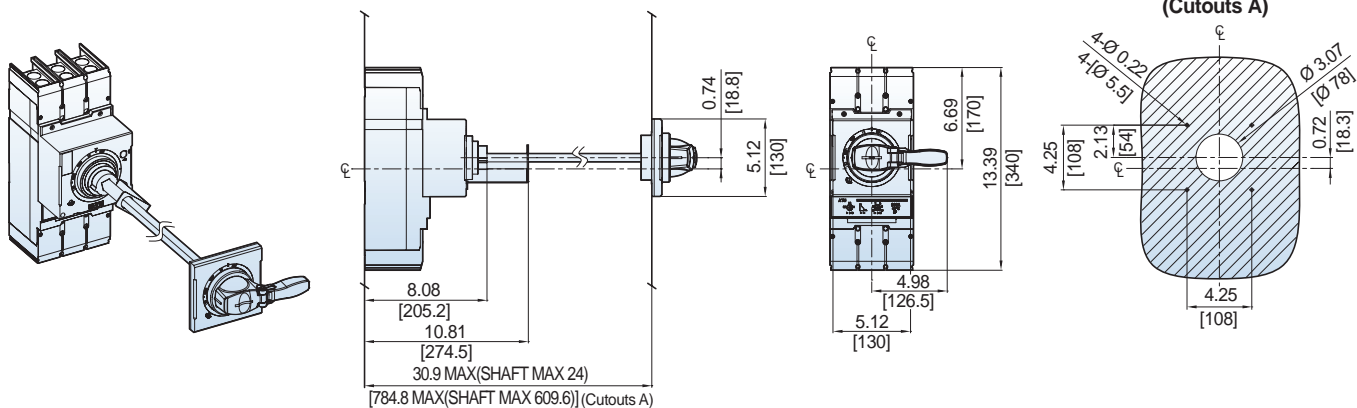

**UTS400/600 NEMA Door-Mounted Rotary Operating Handle [EHU-3, EHV-3, EHX-3]**

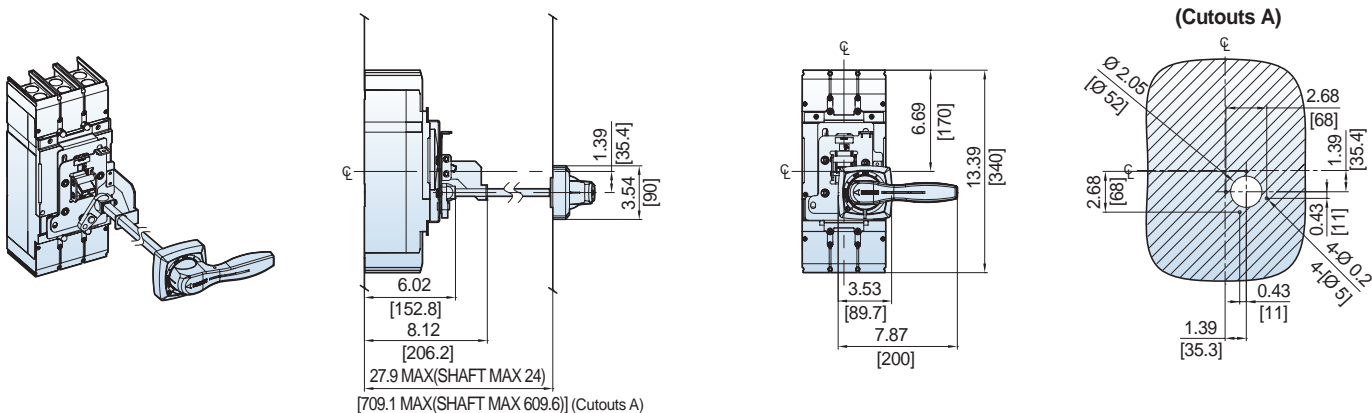

**UTS400/600 Flange-Mounted Cable Operating Handle [FHU-3, FHX-3]**

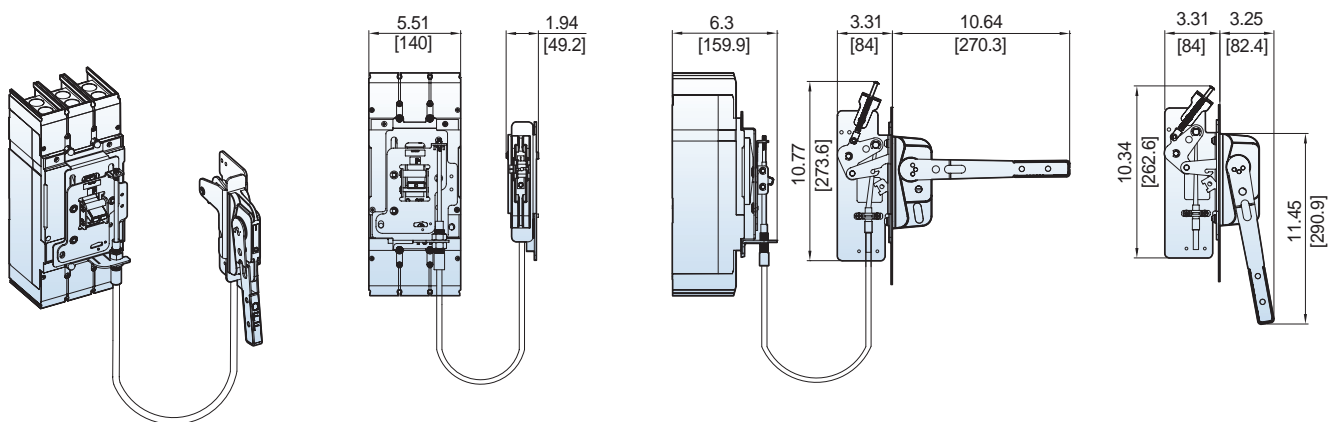

## DIMENSIONS UTS400/600 CIRCUIT BREAKERS

UTS400/600 Flange-Mounted Cable Operating Handle [COM-3 + FHU, X-L + Cable]

Dimension: inch[mm]

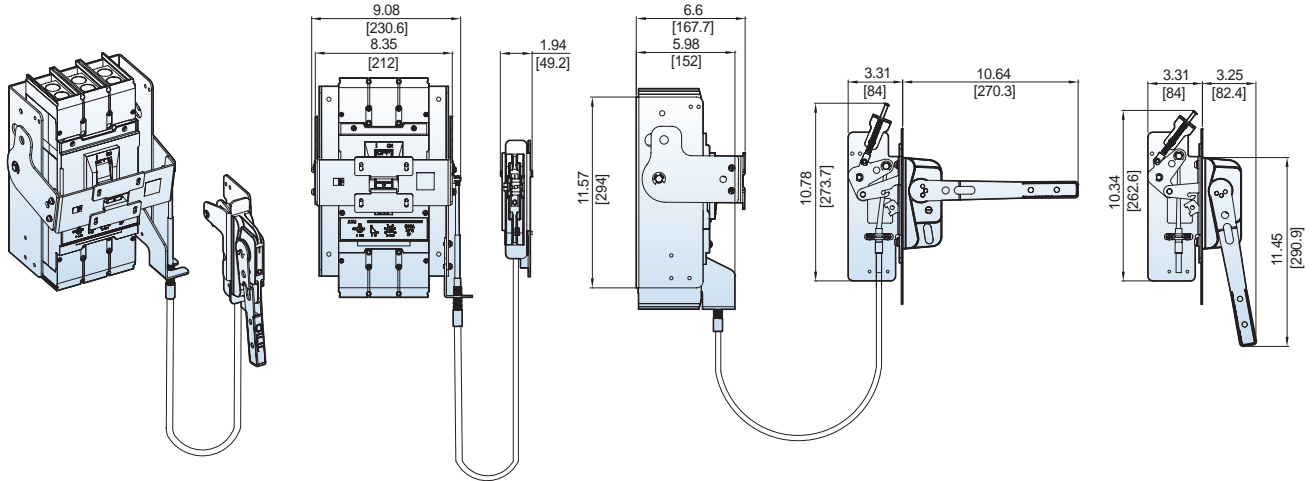

UTS400/600 Flange-Mounted Variable-Depth Operating Handle [VDM-3 +FHU, X-L]

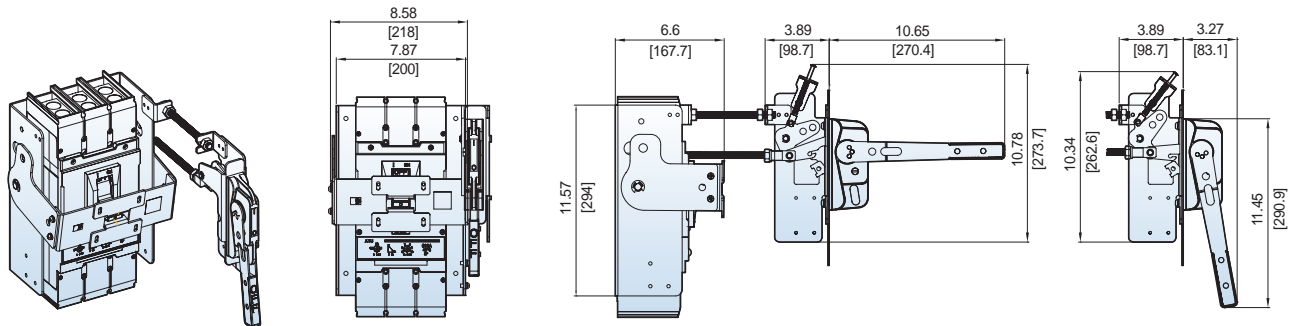

## DIMENSIONS UTS800/1200 CIRCUIT BREAKERS

### UTS800 3P Circuit Breaker [Lug type]

Dimension: inch[mm]

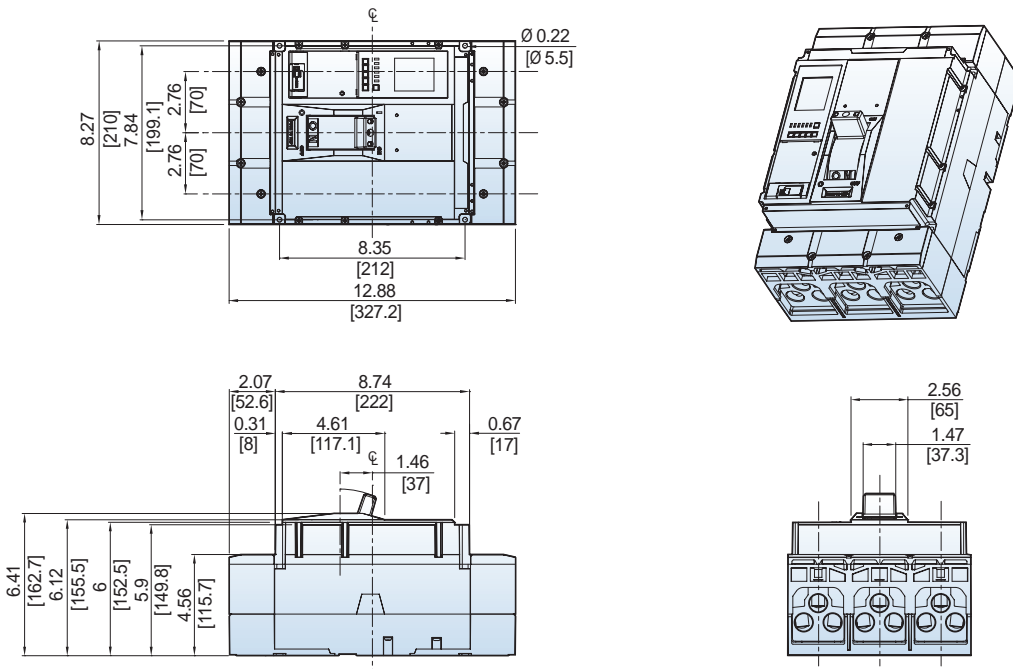

### UTS1200 3P Circuit Breaker [Lug type]

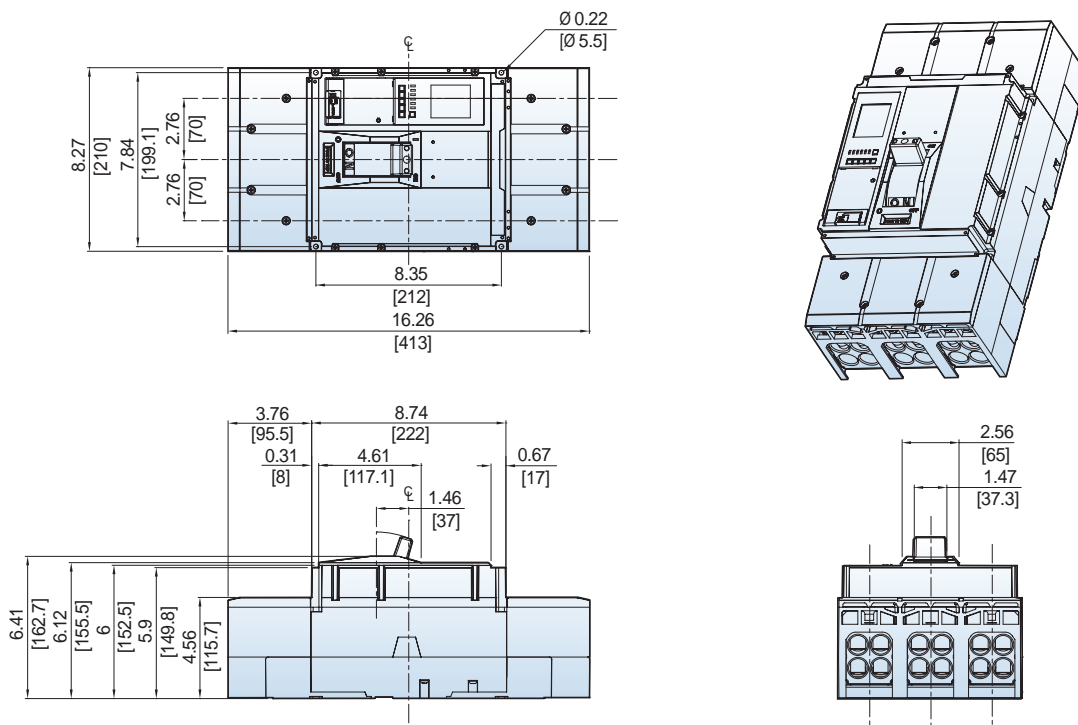

## DIMENSIONS UTS800/1200 CIRCUIT BREAKERS

### UTS800 3P Circuit Breaker [Bolt-on Type]

Dimension: inch[mm]

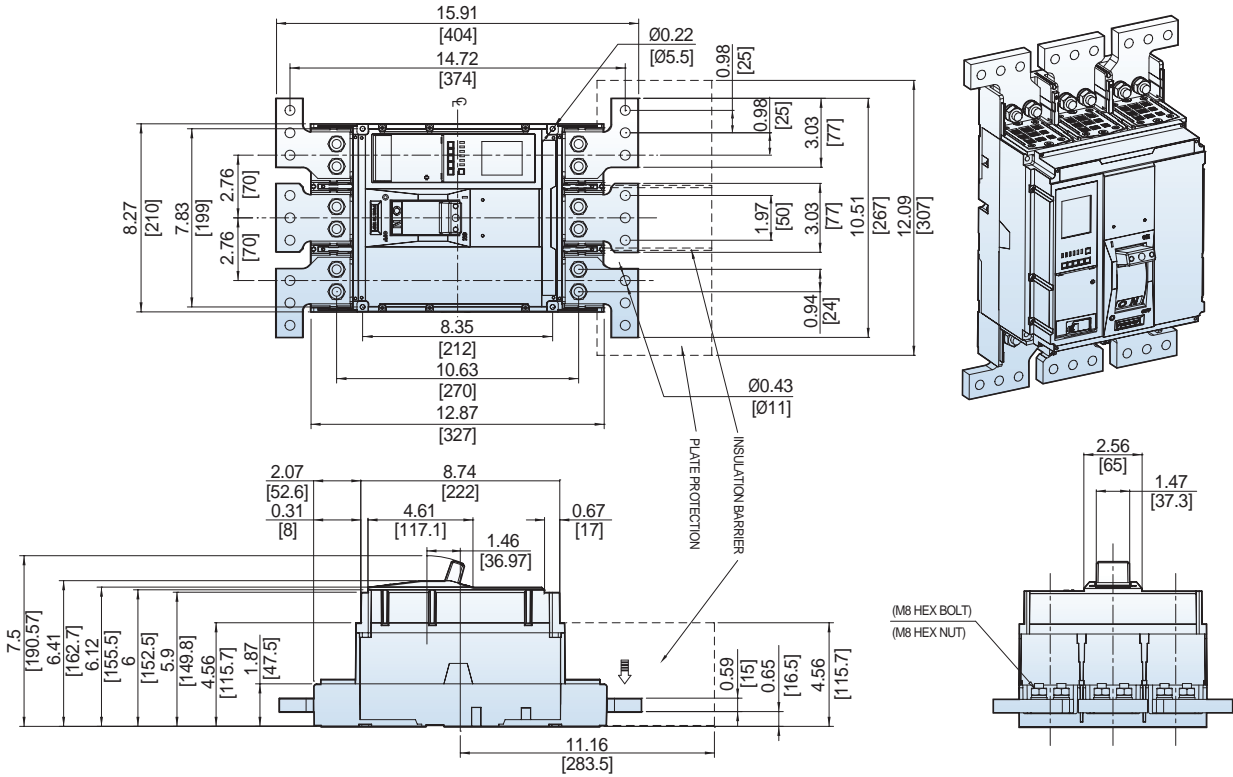

### UTS1200 3P Circuit Breaker [Bolt-on Type]

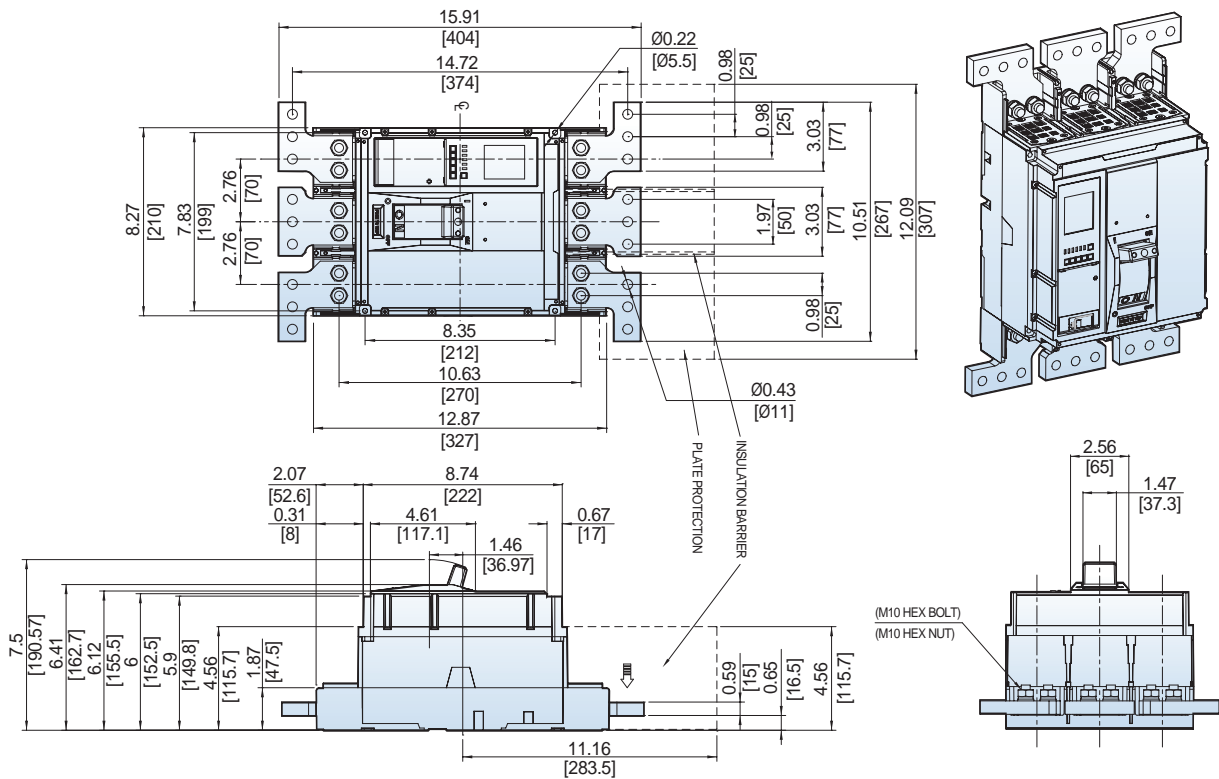



UTS800/1200 Circuit Breaker Mounting

Dimension: inch[mm]

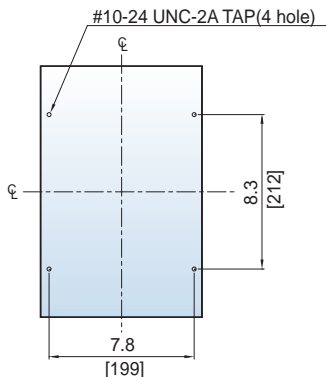

UTS800/1200 Circuit Breaker Door Cutouts

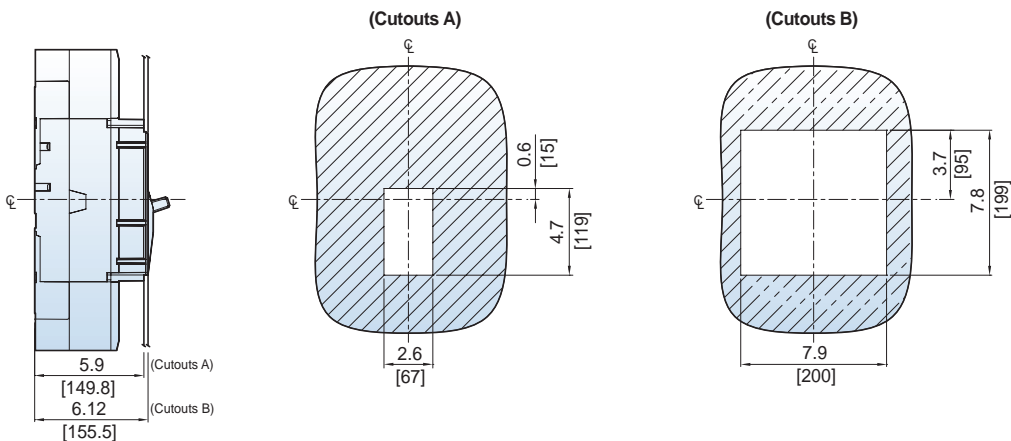

UTS800/1200 Directly Mounted Rotary Operating Handle [DH-5]

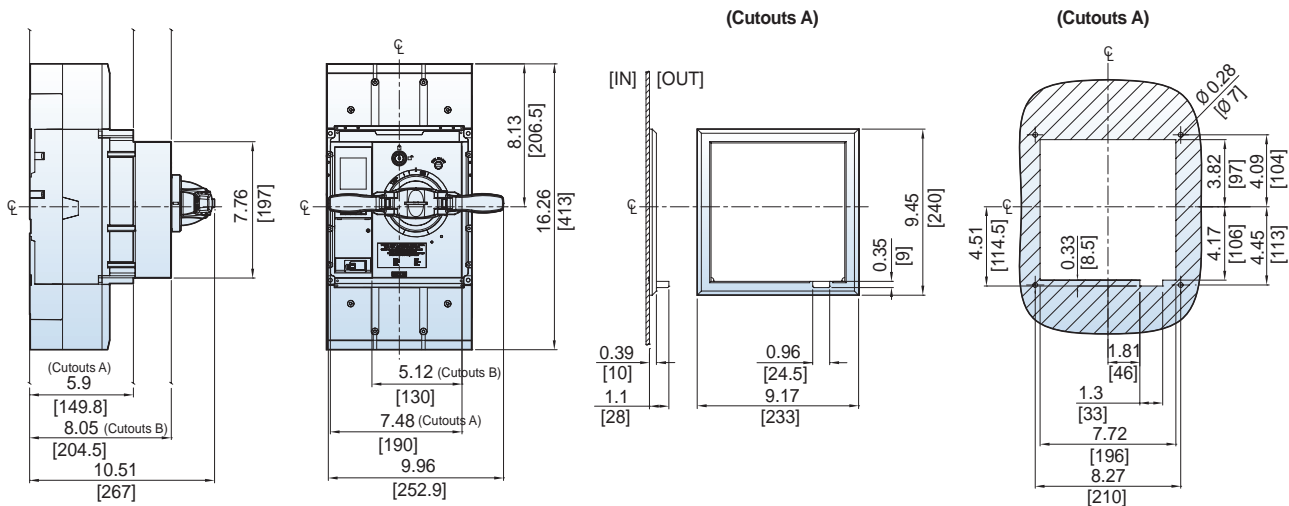

## DIMENSIONS UTS800/1200 CIRCUIT BREAKERS

### UTS800/1200 Directly Mounted Rotary Operating Handle [DH-5]

Dimension: inch[mm]

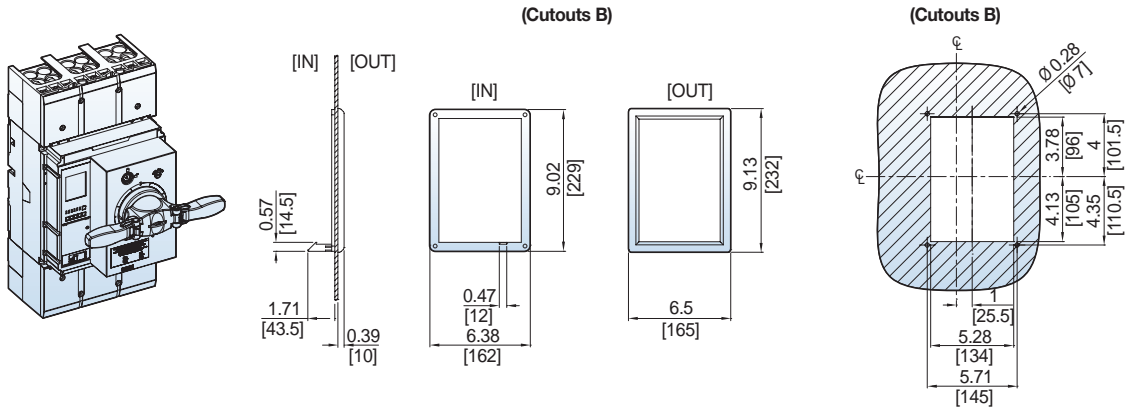

### UTS800/1200 Door-Mounted Rotary Operating Handle [REH-5]

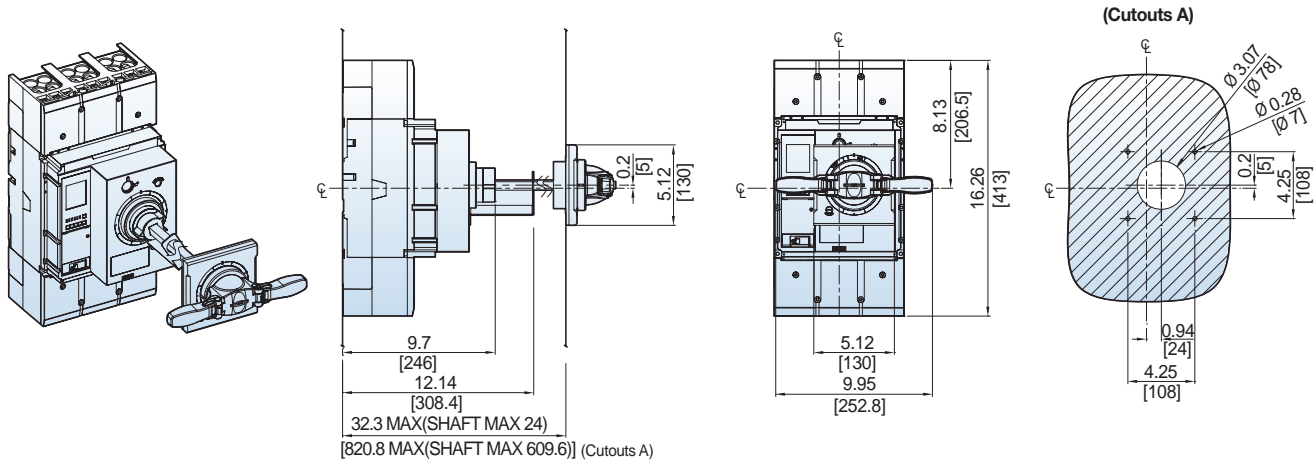

### UTS800/1200 NEMA Door-Mounted Rotary Operating Handle [EHU-5, EHV-5, EHX-5]

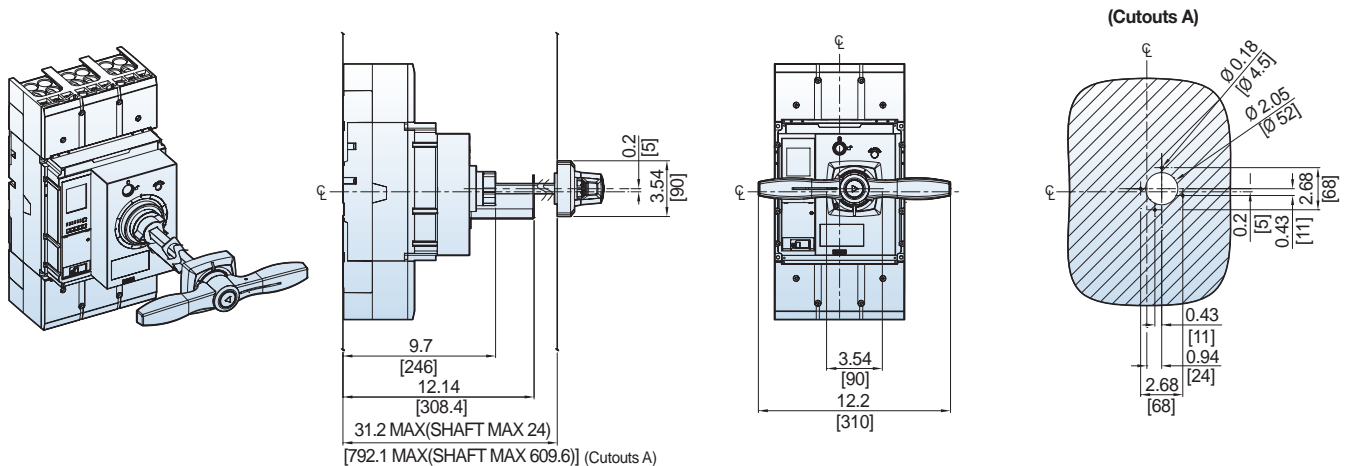

**UTS800/1200 Flange-Mounted Cable Operating Handle [COM-5 + FHU, X-L + Cable]**

Dimension: inch[mm]

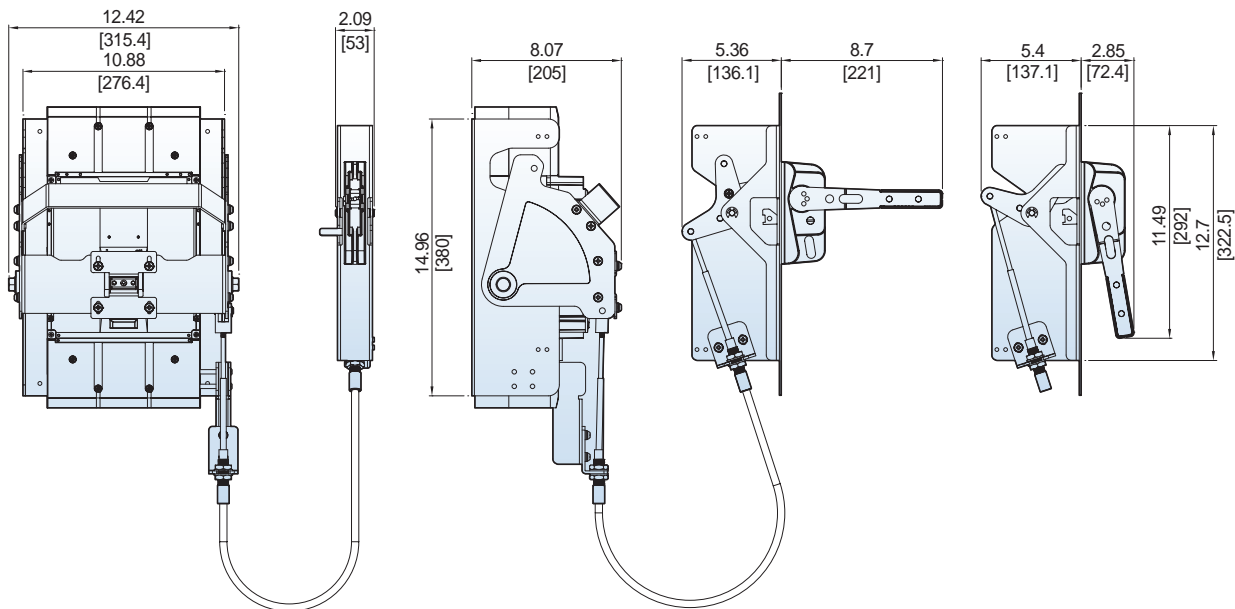

**UTS800/1200 Flange-Mounted Variable-Depth Operating Handle [VDM-5 + FHU, X-L]**

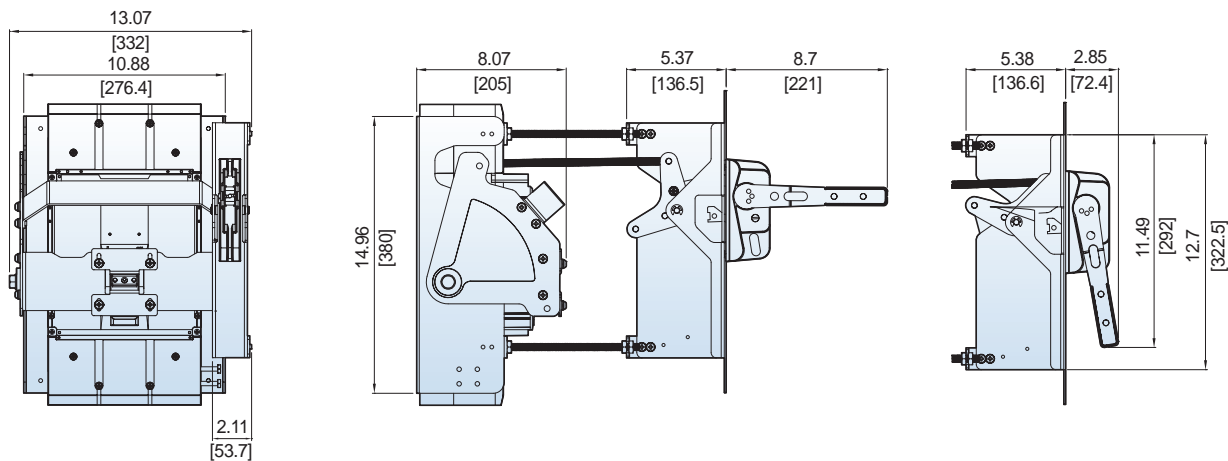

**MEMO**



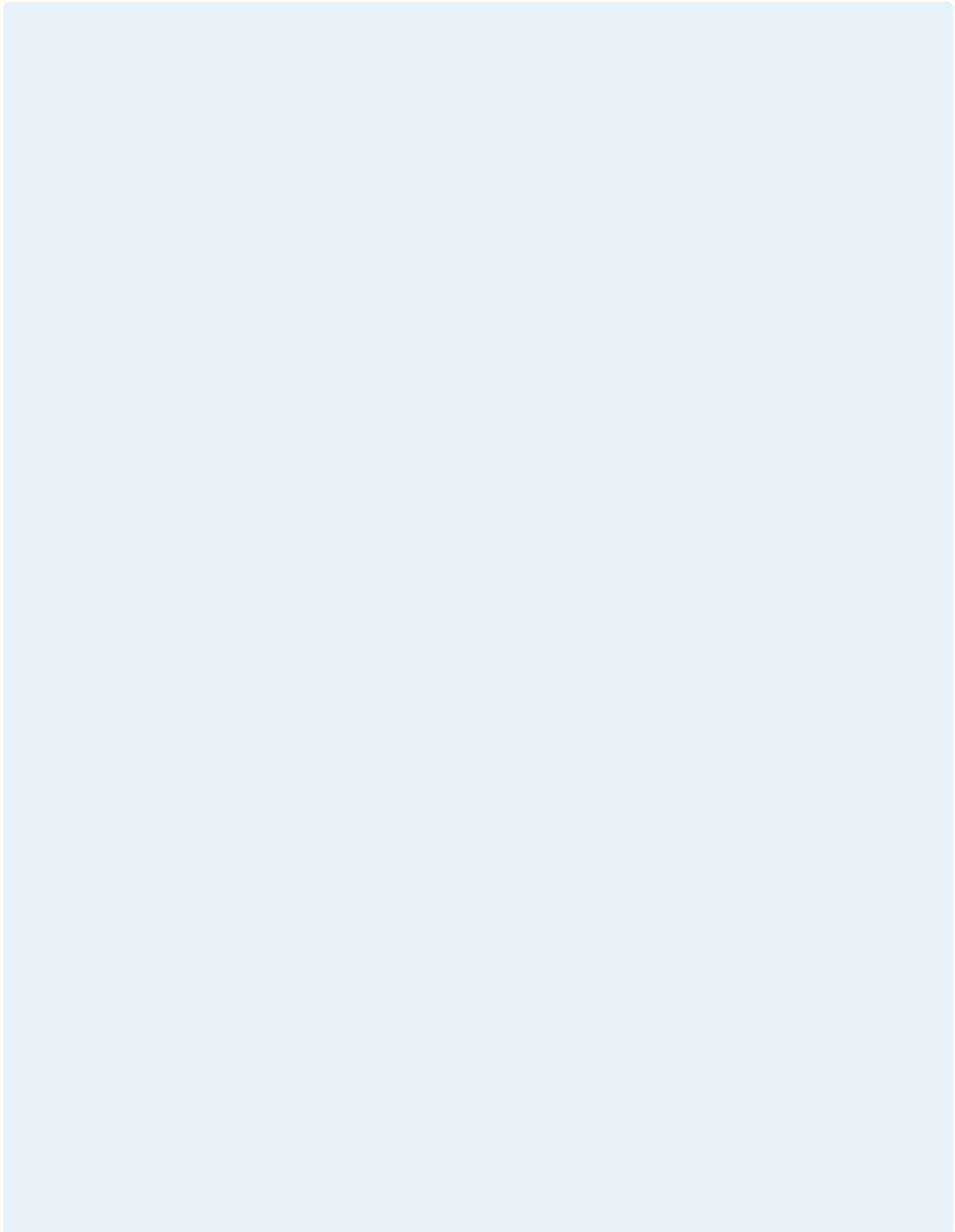



## Safety Instructions

- For your safety, please read user's manual thoroughly before operating.
- Contact the nearest authorized service facility for examination, repair, or adjustment.
- Please contact qualified service technician when you need maintenance.  
Do not disassemble or repair by yourself!
- Any maintenance and inspection shall be performed by the personnel having expertise concerned.



[www.LSElectricAmerica.com](http://www.LSElectricAmerica.com)

### ■ LS ELECTRIC America Inc. Chicago Head Office

980 Woodlands Parkway, Vernon Hills, IL 60061 USA  
Tel: 1-800-891-2941 E-Mail: sales.us@lselectricamerica.com

### ■ Headquarter

127 LS-ro (Hogye-dong) Dongan-gu, Anyang-si, Gyeonggi-Do, 14119, Korea

### ■ Seoul Office

LS Yongsan Tower, 92, Hangang-daero, Yongsan-gu, Seoul, 04386, Korea  
Tel: 82-2-2034-4916, 4684, 4429

### ■ Overseas Subsidiaries

#### • LS ELECTRIC Japan Co., Ltd. (Tokyo, Japan)

Tel: 81-3-6268-8241 E-Mail: japan@lselectric.com

#### • LS ELECTRIC (Dalian) Co., Ltd. (Dalian, China)

Tel: 86-411-8730-5872 E-Mail: china.dalian@lselectric.com.cn

#### • LS ELECTRIC (Wuxi) Co., Ltd. (Wuxi, China)

Tel: 86-510-6851-6666 E-Mail: china.wuxi@lselectric.com.cn

#### • LS ELECTRIC Vietnam Co., Ltd. (Hanoi, Vietnam)

Tel: 84-222-2221-110 E-Mail: vietnam@lselectric.com

#### • LS ELECTRIC Middle East FZE (Dubai, U.A.E.)

Tel: 971-4-886-5360 E-Mail: middleeast@ls-electric.com

#### • LS ELECTRIC Europe B.V. (Hoofddorp, Netherlands)

Tel: 31-20-654-1424 E-Mail: europartner@ls-electric.com

#### • LS ENERGY SOLUTIONS LLC (Charlotte, USA)

Tel: 1-704-587-4051 E-Mail: cmfeldman@ls-es.com

#### • LS ELECTRIC Türkiye Co., Ltd. (Istanbul, Türkiye)

Tel: 90-212-806-1252 E-Mail: turkiye@ls-electric.com

#### • LS ELECTRIC IBERIA S.L.U. (Madrid, Spain)

Tel: 34-910-28-02-74 E-Mail: iberia@ls-electric.com

### ■ Overseas Branches

#### • LS ELECTRIC Tokyo Office (Japan)

Tel: 81-3-6268-8241 E-Mail: tokyo@ls-electric.com

#### • LS ELECTRIC Beijing Office (China)

Tel: 86-10-5095-1631 E-Mail: china@lselectric.com.cn

#### • LS ELECTRIC Shanghai Office (China)

Tel: 86-21-5237-9977 E-Mail: china@lselectric.com.cn

#### • LS ELECTRIC Guangzhou Office (China)

Tel: 86-20-3818-2883 E-Mail: china@lselectric.com.cn

#### • LS ELECTRIC Chengdu Office (China)

Tel: 86-28-8670-3201 E-Mail: china@lselectric.com.cn

#### • LS ELECTRIC Qingdao Office (China)

Tel: 86-532-8501-2065 E-Mail: china@lselectric.com.cn

#### • LS ELECTRIC Nanjing Office (China)

Tel: 86-25-8467-0005 E-Mail: china@lselectric.com.cn

#### • LS ELECTRIC Bangkok Office (Thailand)

Tel: 66-90-950-9683 E-Mail: thailand@ls-electric.com

#### • LS ELECTRIC Jakarta Office (Indonesia)

Tel: 62-21-2933-7614 E-Mail: indonesia@ls-electric.com

#### • LS ELECTRIC Moscow Office (Russia)

Tel: 7-499-682-6130 E-Mail: info@lselectric-ru.com

#### • LS ELECTRIC America Western Office (Irvine, USA)

Tel: 1-949-333-3140 E-Mail: america@ls-electric.com

#### • LS ELECTRIC India Office (India)

Tel: 91-80-6142-9108 E-Mail: info\_india@ls-electric.com

#### • LS ELECTRIC Singapore Office (Singapore)

Tel: 65-6958-8162 E-Mail: singapore@ls-electric.com

#### • LS ELECTRIC Italy Office (Italy)

Tel: 39-030-8081-833 E-Mail: italia@ls-electric.com