

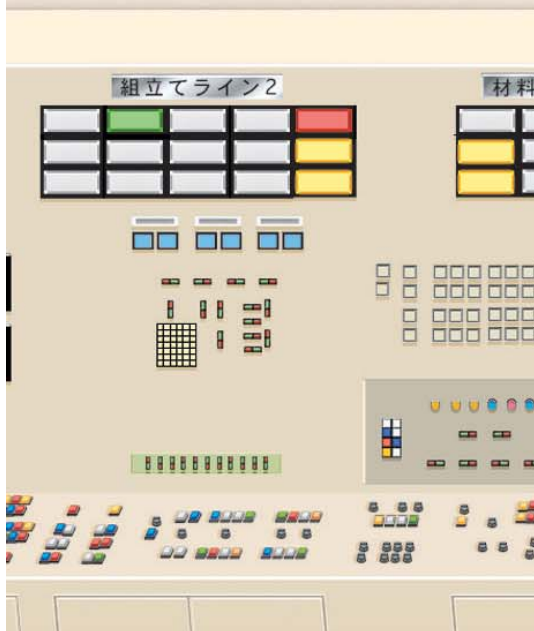









ø22mm LW Series





Control Units









ø22 LW Series Control Units (Selection Guide)

Function	Pushbutton				
Category	Round Flush	Square Flush	Round Flush with Square Bezel	Round Extended	Square Extended
	Momentary/Maintained				
Shape	 RU SP Δ CE	 RU SP Δ CE	 RU SP Δ CE	 RU SP Δ CE	 RU SP Δ CE
Type	LW1B-*1	LW2B-*1	LW3B-*1	LW1B-*2	LW2B-*2
Page	5	5	5	6	6

Function	Pushbutton		Pilot Light (Unibody/Separate Types)		
Category	Round Extended with Square Bezel	ø30mm Mushroom	Round Flush	Square Flush	Round Flush with Square Bezel
	Momentary/Maintained				
Shape	 RU SP Δ CE	 RU SP Δ CE	 RU SP Δ CE	 RU SP Δ CE	 RU SP Δ CE
Type	LW3B-*2	LW1B-*3	LW1P	LW2P	LW3P
Page	6	6	8	8	8

Function	Illuminated Pushbutton				
Category	Round Flush	Round Extended	Square Flush	Round Flush with Square Bezel	ø30mm Mushroom
	Momentary/Maintained				
Shape	 RU SP Δ CE	 RU SP Δ CE	 RU SP Δ CE	 RU SP Δ CE	 RU SP Δ CE
Type	LW1L-*1	LW1L-*2	LW2L-*1	LW3L-*1	LW1L-*3
Page	10	10	10	11	11

Function	Selector Switch		Key Selector Switch	
Category	Round	Round with Square Bezel	Round	Round with Square Bezel
	Shape	 RU SP Δ CE	 RU SP Δ CE	 RU SP Δ CE
Type	LW1S	LW3S	LW1K	LW3K
Page	13	13	14, 15	14, 16





Function	Illuminated Selector Switch		Buzzer	
Category	Round	Round with Square Bezel	Round	Square
			Continuous / Intermittent	
Shape	 RU SP Δ CE	 RU SP Δ CE		
Type	LW1F	LW3F	LW1Z	LW2Z
Page	18	18	19	19

ø22 LW series Control Units

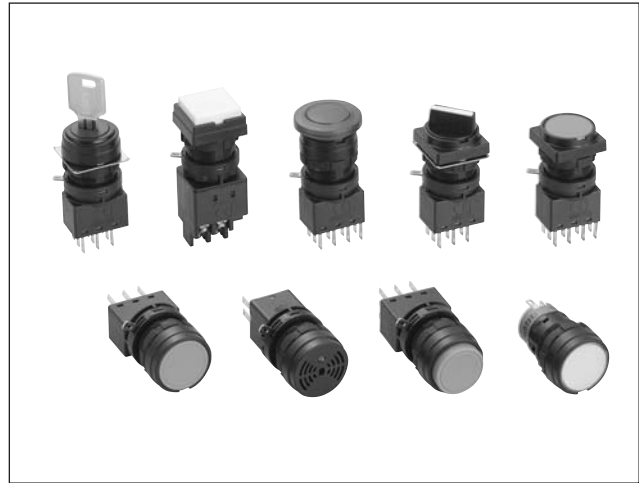
Light touch mechanism designed to reduce strain injuries
Endures repetitive operation suitable for food processing and packaging industries

- Light touch
- Collective mounting is possible.
- Separate type control unit with locking lever enables easy installation even when mounted collectively.
- Gold or silver contacts.
- Degree of protection: IP65 (IEC 60529)
(Buzzer: IP40)
- UL recognized and CSA certified. EN compliant.
(except buzzers)



Safety Standards	File No. or Organization
UL 	UL Recognition File No. E55996
CSA 	File No. LR21451
EN EN60947-1 EN60947-5-1	 TÜV Rheinland
	 EC Low Voltage Directive

Specifications and Ratings

Contact Ratings

• Gold Contact

Maximum Voltage	250V AC/DC	
Thermal Current	3A	
Operating Voltage	125V AC	30V DC
Operating Current (resistive load)	0.1A	0.1A
Contact Material	Gold-clad silver	

Minimum applicable load (reference value): 5V AC/DC, 1mA
 (Applicable range is subject to the operating condition and load.)

• Silver Contact

Operating Voltage		30V	125V	250V	
Operating Current	AC 50/60Hz	Resistive Load	–	3A	
		Inductive Load	–	2A	
	DC	Resistive Load	2A	0.4A	–
		Inductive Load	1A	0.2A	–
Thermal Current		5A			
Contact Material		Silver			

AC inductive load: PF = 0.6 to 0.7





DC inductive load: L/R = 7 msec max.

Specifications

Operating Temperature	–25 to +60°C (no freezing) Illuminated units: –25 to +50°C	
Storage Temperature	–40 to +80°C	
Operating Humidity	45 to 85% RH (no condensation)	
Contact Resistance	50 mΩ maximum (initial value)	
Insulation Resistance	100 MΩ minimum (500V DC megger)	
Dielectric Strength	Switch Unit	Between live part and ground: 2,500V AC, 1 minute Between terminals of different poles: 2,500V AC, 1 minute Between terminals of the same pole: 1,000V AC, 1 minute
	Illumination Unit	Between live part and ground: 2,500V AC, 1 minute
Vibration Resistance	Operating extremes: 5 to 55 Hz, amplitude 0.5 mm	
Shock Resistance	Damage limits: 1,000 m/s ² Operating extremes: 100 m/s ²	
Mechanical Life (minimum operations)	Momentary:	1,000,000
	Maintained:	500,000
	Selector switches:	250,000
	Key selector switches: Illuminated selector switches:	250,000
Electrical Life (minimum operations)	Momentary:	100,000 (*1)
	Maintained:	100,000 (*2)
	Selector switches:	100,000 (*2)
	*1 Switching frequency 1,800 operations/h *2 Switching frequency 900 operations/h	
Degree of Protection	IP65 (IEC 60529) (Buzzer: IP40)	
Terminal Style	Solder/tab terminal no. 110 PC board terminal Screw terminal	

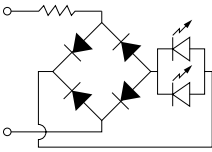
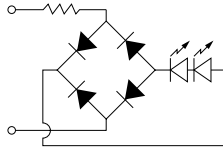
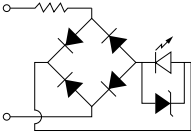
ø22 LW Series Control Units

LED Lamp Ratings (LSTD Type)

Type No.	LSTD-6②		LSTD-1②	LSTD-2②
Lamp Base	BA9S/13			
Rated Voltage	6V AC/DC		12V AC/DC	24V AC/DC
Voltage Range	6V AC/DC ±10%		12V AC/DC ±10%	24V AC/DC ±10%
Current Draw	AC	A, R, W, Y: 17 mA G, S: 8 mA	11 mA	11 mA
	DC	A, R, W, Y: 14 mA G, S: 5.5 mA	10 mA	10 mA
Color Code ②	A (amber), G (green), R (red), S (blue), W (white), Y (yellow)			
Lamp Base Color	Same as illumination color			
Voltage Marking	Die stamped on the base			
Life (reference value)	Approx. 50,000 hours (The luminance is reduced to 50% the initial intensity when used on complete DC.)			
Internal Circuit	A, R, W, Y			
				
	G, S			
		 LED Chip  Protection Diode  Zener Diode		

Mounting Hole Layout

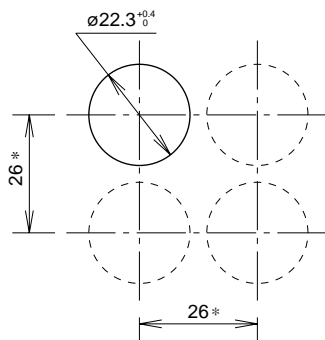

Note: Determine the mounting centers to ensure easy operation.







- ø30mm Mushroom: Vertical: 32 mm minimum
Horizontal: 32 mm minimum
- Solder/Tab Terminal
 - Without terminal cover: Vertical: 26 mm minimum
Horizontal: 26 mm minimum
 - With terminal cover: Vertical: 26 mm minimum
Horizontal: 27 mm minimum
- Screw terminal: Vertical: 40 mm minimum
Horizontal: 26 mm minimum
- PC board terminal: Vertical: 26 mm minimum
Horizontal: 26 mm minimum

Ordering Information

Standard Units









- Specify a button or lens color code in the Type No.
- All illuminated units are supplied with an LED lamp.
- All standard units are UL recognized, CSA certified, and EN compliant (TÜV Rheinland).

Flush Types

Shape	Operation Type	Contact Material	Contact	Type No.			① Button Color Code
				Solder/Tab Terminal	PC Board Terminal	Screw Terminal	
Round Flush LW1B-M1 LW1B-A1  	Momentary	Gold	SPDT	LW1B-M1C1①	LW1B-M1C1V①	—	Specify a button color code in place of ① in the Type No. B: black G: green R: red S: blue W: white Y: yellow
			DPDT	LW1B-M1C2①	LW1B-M1C2V①	LW1B-M1C2M①	
			3PDT	LW1B-M1C3①	LW1B-M1C3V①	—	
		Silver	SPDT	LW1B-M1C5①	—	—	
			DPDT	LW1B-M1C6①	—	LW1B-M1C6M①	
			3PDT	LW1B-M1C7①	—	—	
	Maintained	Gold	SPDT	LW1B-A1C1①	LW1B-A1C1V①	—	
			DPDT	LW1B-A1C2①	LW1B-A1C2V①	LW1B-A1C2M①	
			3PDT	LW1B-A1C3①	LW1B-A1C3V①	—	
		Silver	SPDT	LW1B-A1C5①	—	—	
			DPDT	LW1B-A1C6①	—	LW1B-A1C6M①	
			3PDT	LW1B-A1C7①	—	—	
Square Flush LW2B-M1 LW2B-A1  	Momentary	Gold	SPDT	LW2B-M1C1①	LW2B-M1C1V①	—	
			DPDT	LW2B-M1C2①	LW2B-M1C2V①	LW2B-M1C2M①	
			3PDT	LW2B-M1C3①	LW2B-M1C3V①	—	
		Silver	SPDT	LW2B-M1C5①	—	—	
			DPDT	LW2B-M1C6①	—	LW2B-M1C6M①	
			3PDT	LW2B-M1C7①	—	—	
	Maintained	Gold	SPDT	LW2B-A1C1①	LW2B-A1C1V①	—	
			DPDT	LW2B-A1C2①	LW2B-A1C2V①	LW2B-A1C2M①	
			3PDT	LW2B-A1C3①	LW2B-A1C3V①	—	
		Silver	SPDT	LW2B-A1C5①	—	—	
			DPDT	LW2B-A1C6①	—	LW2B-A1C6M①	
			3PDT	LW2B-A1C7①	—	—	
Round Flush with Square Bezel LW3B-M1 LW3B-A1  	Momentary	Gold	SPDT	LW3B-M1C1①	LW3B-M1C1V①	—	
			DPDT	LW3B-M1C2①	LW3B-M1C2V①	LW3B-M1C2M①	
			3PDT	LW3B-M1C3①	LW3B-M1C3V①	—	
		Silver	SPDT	LW3B-M1C5①	—	—	
			DPDT	LW3B-M1C6①	—	LW3B-M1C6M①	
			3PDT	LW3B-M1C7①	—	—	
	Maintained	Gold	SPDT	LW3B-A1C1①	LW3B-A1C1V①	—	
			DPDT	LW3B-A1C2①	LW3B-A1C2V①	LW3B-A1C2M①	
			3PDT	LW3B-A1C3①	LW3B-A1C3V①	—	
		Silver	SPDT	LW3B-A1C5①	—	—	
			DPDT	LW3B-A1C6①	—	LW3B-A1C6M①	
			3PDT	LW3B-A1C7①	—	—	

ø22 LW Series Pushbuttons

Extended / Mushroom Types

Shape	Operation Type	Contact Material	Contact	Type No.			① Button Color Code
				Solder/Tab Terminal	PC Board Terminal	Screw Terminal	
Round Extended LW1B-M2 LW1B-A2  	Momentary	Gold	SPDT	LW1B-M2C1①	LW1B-M2C1V①	—	Specify a button color code in place of ① in the Type No. B: black G: green R: red S: blue W: white Y: yellow
			DPDT	LW1B-M2C2①	LW1B-M2C2V①	LW1B-M2C2M①	
			3PDT	LW1B-M2C3①	LW1B-M2C3V①	—	
		Silver	SPDT	LW1B-M2C5①	—	—	
			DPDT	LW1B-M2C6①	—	LW1B-M2C6M①	
			3PDT	LW1B-M2C7①	—	—	
	Maintained	Gold	SPDT	LW1B-A2C1①	LW1B-A2C1V①	—	
			DPDT	LW1B-A2C2①	LW1B-A2C2V①	LW1B-A2C2M①	
			3PDT	LW1B-A2C3①	LW1B-A2C3V①	—	
		Silver	SPDT	LW1B-A2C5①	—	—	
			DPDT	LW1B-A2C6①	—	LW1B-A2C6M①	
			3PDT	LW1B-A2C7①	—	—	
Square Extended LW2B-M2 LW2B-A2  	Momentary	Gold	SPDT	LW2B-M2C1①	LW2B-M2C1V①	—	
			DPDT	LW2B-M2C2①	LW2B-M2C2V①	LW2B-M2C2M①	
			3PDT	LW2B-M2C3①	LW2B-M2C3V①	—	
		Silver	SPDT	LW2B-M2C5①	—	—	
			DPDT	LW2B-M2C6①	—	LW2B-M2C6M①	
			3PDT	LW2B-M2C7①	—	—	
	Maintained	Gold	SPDT	LW2B-A2C1①	LW2B-A2C1V①	—	
			DPDT	LW2B-A2C2①	LW2B-A2C2V①	LW2B-A2C2M①	
			3PDT	LW2B-A2C3①	LW2B-A2C3V①	—	
		Silver	SPDT	LW2B-A2C5①	—	—	
			DPDT	LW2B-A2C6①	—	LW2B-A2C6M①	
			3PDT	LW2B-A2C7①	—	—	
Round Extended with Square Bezel LW3B-M2 LW3B-A2  	Momentary	Gold	SPDT	LW3B-M2C1①	LW3B-M2C1V①	—	
			DPDT	LW3B-M2C2①	LW3B-M2C2V①	LW3B-M2C2M①	
			3PDT	LW3B-M2C3①	LW3B-M2C3V①	—	
		Silver	SPDT	LW3B-M2C5①	—	—	
			DPDT	LW3B-M2C6①	—	LW3B-M2C6M①	
			3PDT	LW3B-M2C7①	—	—	
	Maintained	Gold	SPDT	LW3B-A2C1①	LW3B-A2C1V①	—	
			DPDT	LW3B-A2C2①	LW3B-A2C2V①	LW3B-A2C2M①	
			3PDT	LW3B-A2C3①	LW3B-A2C3V①	—	
		Silver	SPDT	LW3B-A2C5①	—	—	
			DPDT	LW3B-A2C6①	—	LW3B-A2C6M①	
			3PDT	LW3B-A2C7①	—	—	
ø30mm Mushroom LW1B-M3 LW1B-A3  	Momentary	Gold	SPDT	LW1B-M3C1①	LW1B-M3C1V①	—	
			DPDT	LW1B-M3C2①	LW1B-M3C2V①	LW1B-M3C2M①	
			3PDT	LW1B-M3C3①	LW1B-M3C3V①	—	
		Silver	SPDT	LW1B-M3C5①	—	—	
			DPDT	LW1B-M3C6①	—	LW1B-M3C6M①	
			3PDT	LW1B-M3C7①	—	—	
	Maintained	Gold	SPDT	LW1B-A3C1①	LW1B-A3C1V①	—	
			DPDT	LW1B-A3C2①	LW1B-A3C2V①	LW1B-A3C2M①	
			3PDT	LW1B-A3C3①	LW1B-A3C3V①	—	
		Silver	SPDT	LW1B-A3C5①	—	—	
			DPDT	LW1B-A3C6①	—	LW1B-A3C6M①	
			3PDT	LW1B-A3C7①	—	—	

Dimensions

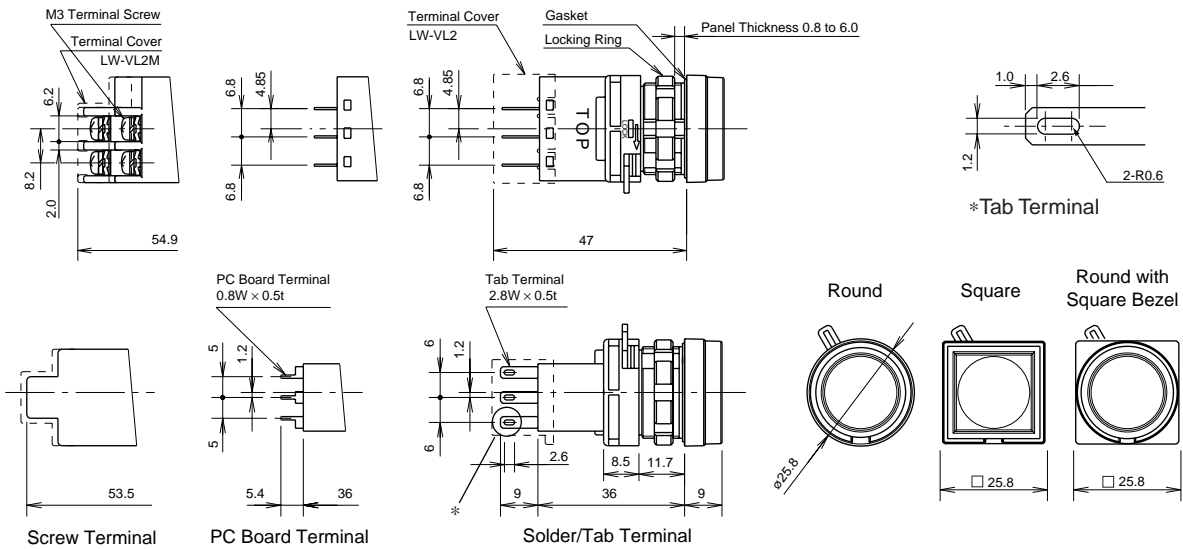

• Bottom View

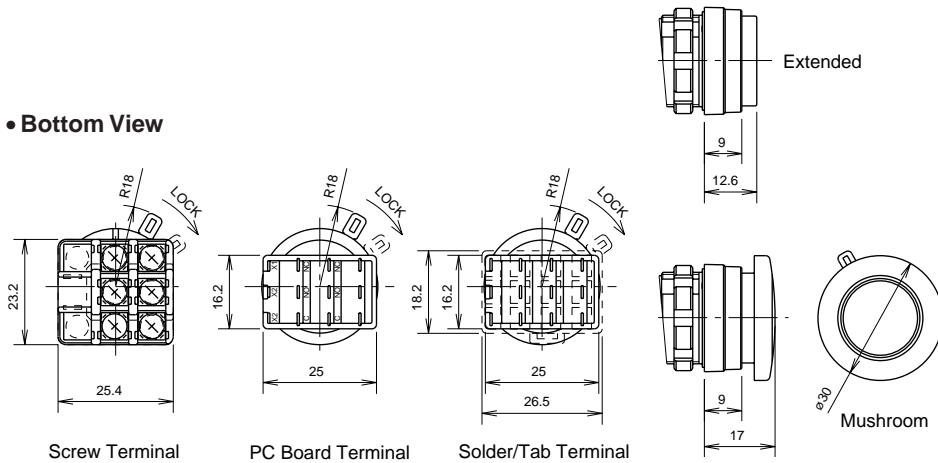

Terminal Arrangement (Bottom View)

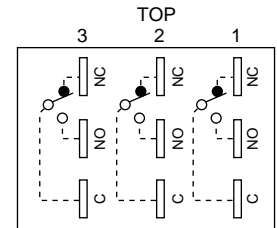

Note: SPDT has C, NO, and NC only in the center.
 DPDT has C, NO, and NC only on the right and left.
 Screw terminal type is DPDT.

PC Board Drilling Layout (Bottom View)

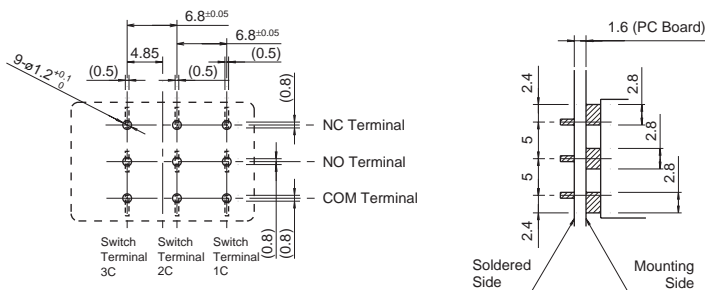







Pay attention to the pattern of the PC board as the terminals on the mounting surface are 2.8 mm wide.

All dimensions in mm.

ø22 LW Series Pilot Lights

Unibody / Separate Types

Shape	Operating Voltage	Type No			② Lens Color Code
		Solder/Tab Terminal (Unibody Type)	PC Board Terminal (Separate Type)	Screw Terminal (Unibody Type)	
Round Flush LW1P  	6V AC/DC±10%	LW1P-12②	LW1P-1C02V②	LW1P-12M②	Specify a lens color code in place of ② in the Type No. A: amber G: green R: red S: blue W: white Y: yellow
	12V AC/DC±10%	LW1P-13②	LW1P-1C03V②	LW1P-13M②	
	24V AC/DC±10%	LW1P-14②	LW1P-1C04V②	LW1P-14M②	
Square Flush LW2P  	6V AC/DC±10%	LW2P-12②	LW2P-1C02V②	LW2P-12M②	
	12V AC/DC±10%	LW2P-13②	LW2P-1C03V②	LW2P-13M②	
	24V AC/DC±10%	LW2P-14②	LW2P-1C04V②	LW2P-14M②	
Round Flush with Square Bezel LW3P  	6V AC/DC±10%	LW3P-12②	LW3P-1C02V②	LW3P-12M②	
	12V AC/DC±10%	LW3P-13②	LW3P-1C03V②	LW3P-13M②	
	24V AC/DC±10%	LW3P-14②	LW3P-1C04V②	LW3P-14M②	

• Every pilot light is supplied with an LED lamp (LSTD) of the specified color and voltage.

Dimensions

• Unibody Type

• Separate Type

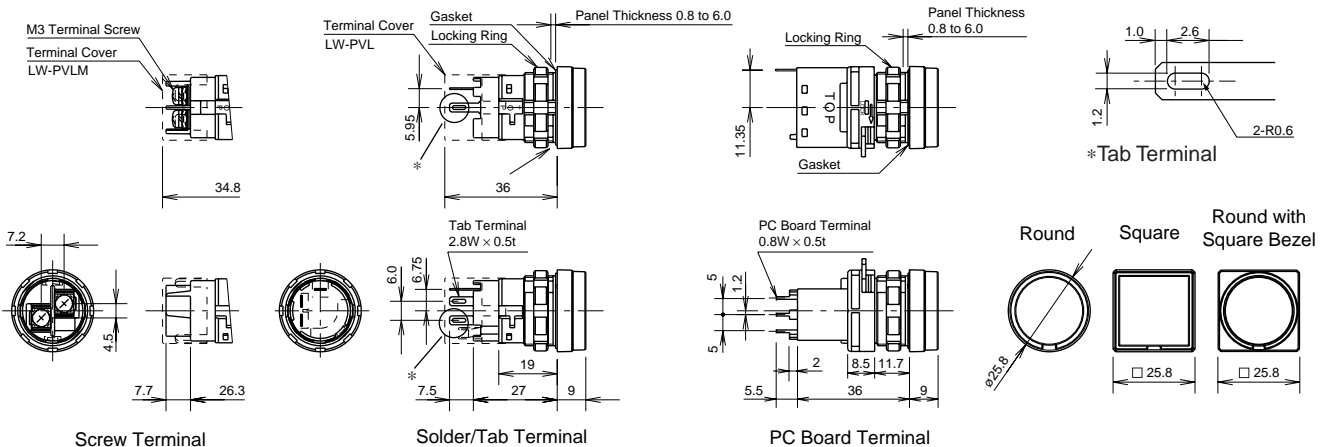

All dimensions in mm.

Terminal Arrangement

• Unibody Type

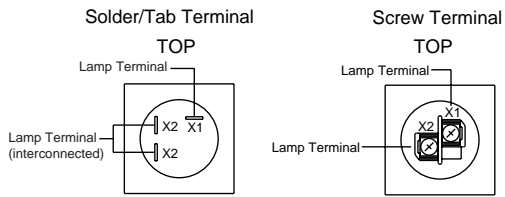

• Lamp terminals do not have any polarity.

• Separate Type

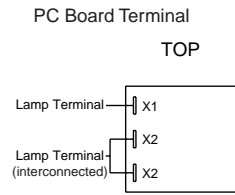

• Lamp terminals do not have any polarity.

PC Board Drilling Layout (Bottom View)

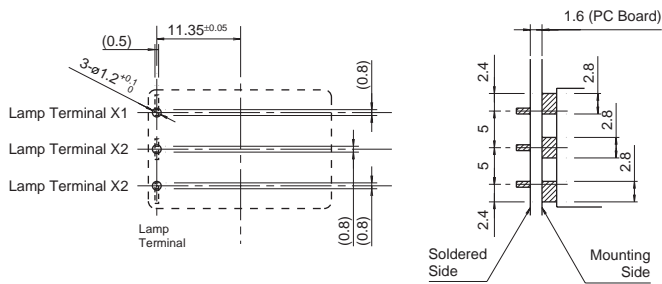







Pay attention to the pattern of the PC board as the terminals on the mounting surface are 2.8 mm wide.

All dimensions in mm.

ø22 LW Series Illuminated Pushbuttons

Flush / Extended Illuminated Pushbuttons





Shape	Lamp	Operation Type	Contact Material	Contact	Type No.		
					Solder/Tab Terminal	PC Board Terminal	Screw Terminal
Round Flush LW1L-M1 LW1L-A1  	LED	Momentary	Gold	SPDT	LW1L-M1C1③②	LW1L-M1C1③V②	—
				DPDT	LW1L-M1C2③②	LW1L-M1C2③V②	LW1L-M1C2③M②
				3PDT	LW1L-M1C3③②	LW1L-M1C3③V②	—
			Silver	SPDT	LW1L-M1C5③②	—	—
				DPDT	LW1L-M1C6③②	—	LW1L-M1C6③M②
				3PDT	LW1L-M1C7③②	—	—
		Maintained	Gold	SPDT	LW1L-A1C1③②	LW1L-A1C1③V②	—
				DPDT	LW1L-A1C2③②	LW1L-A1C2③V②	LW1L-A1C2③M②
				3PDT	LW1L-A1C3③②	LW1L-A1C3③V②	—
			Silver	SPDT	LW1L-A1C5③②	—	—
				DPDT	LW1L-A1C6③②	—	LW1L-A1C6③M②
				3PDT	LW1L-A1C7③②	—	—
Round Extended LW1L-M2 LW1L-A2  	LED	Momentary	Gold	SPDT	LW1L-M2C1③②	LW1L-M2C1③V②	—
				DPDT	LW1L-M2C2③②	LW1L-M2C2③V②	LW1L-M2C2③M②
				3PDT	LW1L-M2C3③②	LW1L-M2C3③V②	—
			Silver	SPDT	LW1L-M2C5③②	—	—
				DPDT	LW1L-M2C6③②	—	LW1L-M2C6③M②
				3PDT	LW1L-M2C7③②	—	—
		Maintained	Gold	SPDT	LW1L-A2C1③②	LW1L-A2C1③V②	—
				DPDT	LW1L-A2C2③②	LW1L-A2C2③V②	LW1L-A2C2③M②
				3PDT	LW1L-A2C3③②	LW1L-A2C3③V②	—
			Silver	SPDT	LW1L-A2C5③②	—	—
				DPDT	LW1L-A2C6③②	—	LW1L-A2C6③M②
				3PDT	LW1L-A2C7③②	—	—
Square Flush LW2L-M1 LW2L-A1  	LED	Momentary	Gold	SPDT	LW2L-M1C1③②	LW2L-M1C1③V②	—
				DPDT	LW2L-M1C2③②	LW2L-M1C2③V②	LW2L-M1C2③M②
				3PDT	LW2L-M1C3③②	LW2L-M1C3③V②	—
			Silver	SPDT	LW2L-M1C5③②	—	—
				DPDT	LW2L-M1C6③②	—	LW2L-M1C6③M②
				3PDT	LW2L-M1C7③②	—	—
		Maintained	Gold	SPDT	LW2L-A1C1③②	LW2L-A1C1③V②	—
				DPDT	LW2L-A1C2③②	LW2L-A1C2③V②	LW2L-A1C2③M②
				3PDT	LW2L-A1C3③②	LW2L-A1C3③V②	—
			Silver	SPDT	LW2L-A1C5③②	—	—
				DPDT	LW2L-A1C6③②	—	LW2L-A1C6③M②
				3PDT	LW2L-A1C7③②	—	—

• Color Code and Operating Voltage Code

② Lens/LED Color Code	③ Operating Voltage Code
Specify a Lens/LED color code in place of ② in the Type No.	Specify an operating voltage code in place of ③ in the Type No.
A: amber G: green R: red S: blue W: white Y: yellow	2: 6V AC/DC 3: 12V AC/DC 4: 24V AC/DC

• Every illuminated pushbutton contains an LED lamp (LSTD) of the specified color and voltage.

Flush / Mushroom Illuminated Pushbuttons

Shape	Lamp	Operation Type	Contact Material	Contact	Type No.				
					Solder/Tab Terminal	PC Board Terminal	Screw Terminal		
Round Flush with Square Bezel LW3L-M1 LW3L-A1  	LED	Momentary	Gold	SPDT	LW3L-M1C1③②	LW3L-M1C1③V②	—		
				DPDT	LW3L-M1C2③②	LW3L-M1C2③V②	LW3L-M1C2③M②		
				3PDT	LW3L-M1C3③②	LW3L-M1C3③V②	—		
			Silver	SPDT	LW3L-M1C5③②	—	—		
				DPDT	LW3L-M1C6③②	—	LW3L-M1C6③M②		
				3PDT	LW3L-M1C7③②	—	—		
		Maintained	Gold	SPDT	LW3L-A1C1③②	LW3L-A1C1③V②	—		
				DPDT	LW3L-A1C2③②	LW3L-A1C2③V②	LW3L-A1C2③M②		
				3PDT	LW3L-A1C3③②	LW3L-A1C3③V②	—		
			Silver	SPDT	LW3L-A1C5③②	—	—		
				DPDT	LW3L-A1C6③②	—	LW3L-A1C6③M②		
				3PDT	LW3L-A1C7③②	—	—		
		ø30mm Mushroom LW1L-M3 LW1L-A3  	LED	Momentary	Gold	SPDT	LW1L-M3C1③②	LW1L-M3C1③V②	—
						DPDT	LW1L-M3C2③②	LW1L-M3C2③V②	LW1L-M3C2③M②
3PDT	LW1L-M3C3③②					LW1L-M3C3③V②	—		
Silver	SPDT				LW1L-M3C5③②	—	—		
	DPDT				LW1L-M3C6③②	—	LW1L-M3C6③M②		
	3PDT				LW1L-M3C7③②	—	—		
Maintained	Gold			SPDT	LW1L-A3C1③②	LW1L-A3C1③V②	—		
				DPDT	LW1L-A3C2③②	LW1L-A3C2③V②	LW1L-A3C2③M②		
				3PDT	LW1L-A3C3③②	LW1L-A3C3③V②	—		
	Silver			SPDT	LW1L-A3C5③②	—	—		
				DPDT	LW1L-A3C6③②	—	LW1L-A3C6③M②		
				3PDT	LW1L-A3C7③②	—	—		

• Color Code and Operating Voltage Code

② Lens/LED Color Code	③ Operating Voltage Code
Specify a Lens/LED color code in place of ② in the Type No.	Specify an operating voltage code in place of ③ in the Type No.
A: amber G: green R: red S: blue W: white Y: yellow	2: 6V AC/DC 3: 12V AC/DC 4: 24V AC/DC

- Every illuminated pushbutton contains an LED lamp (LSTD) of the specified color and voltage.

ø22 LW Series Illuminated Pushbuttons

Dimensions

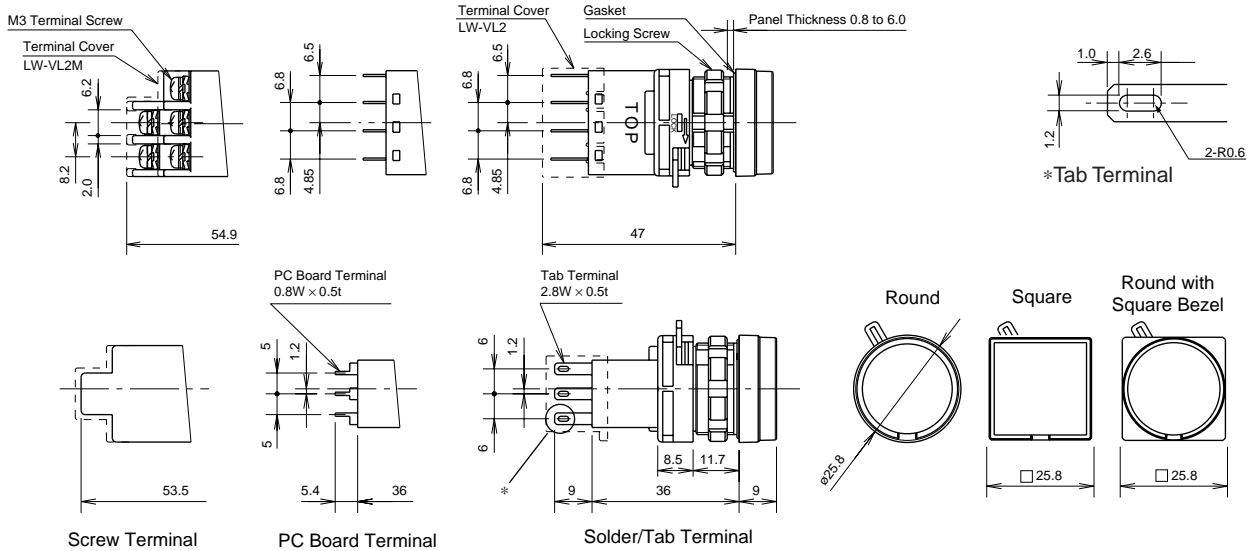

• Bottom View

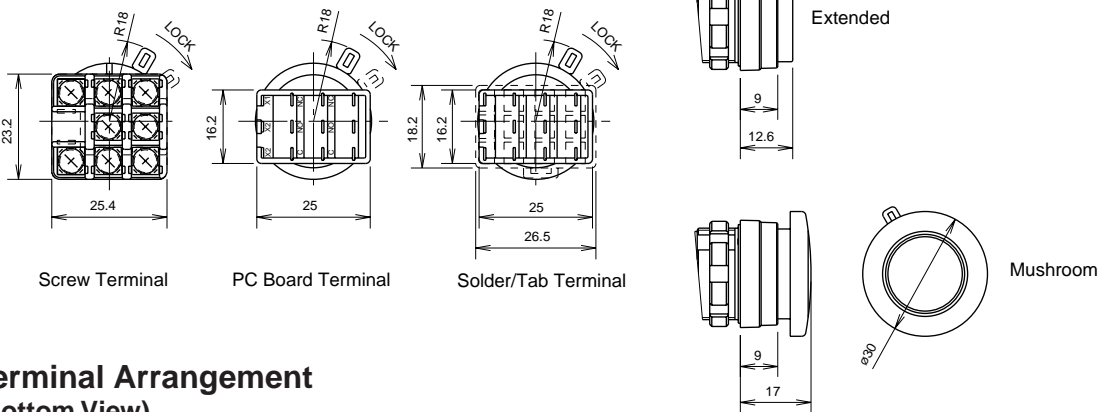

Terminal Arrangement (Bottom View)

• Solder/Tab Terminal

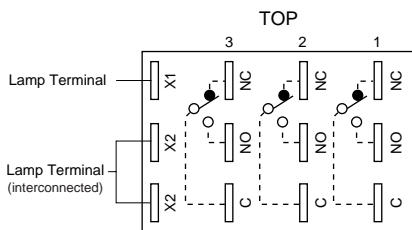

• Screw Terminal

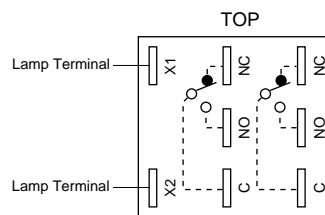

Note: SPDT has C, NO, and NC only in the center.
 DPDT has C, NO, and NC only on the right and left.
 Lamp terminals do not have any polarities.



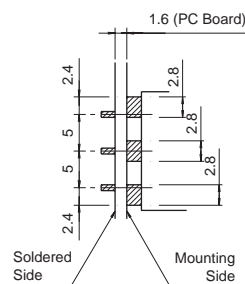
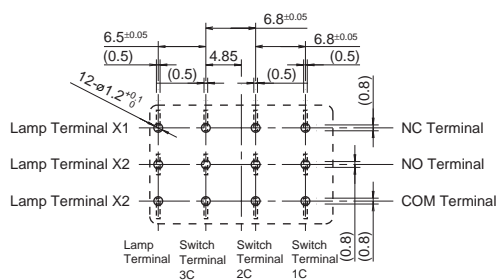





PC Board Drilling Layout (Bottom View)





All dimensions in mm.

Pay attention to the pattern of the PC board as the terminals on the mounting surface are 2.8 mm wide.

Selector Switches



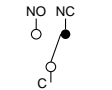
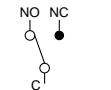
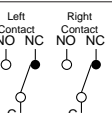
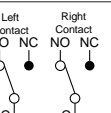
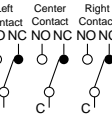
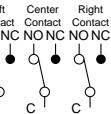

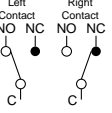
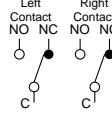
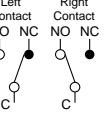
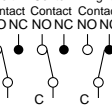
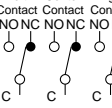
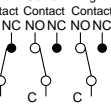
Shape	Operation Type	Position	Contact Material	Contact	Type No.					
					Solder/Tab Terminal	PC Board Terminal	Screw Terminal			
Round LW1S  	90° 2-position Maintained		Gold	SPDT	LW1S-2C1	LW1S-2C1V	—			
				DPDT	LW1S-2C2	LW1S-2C2V	LW1S-2C2M			
				3PDT	LW1S-2C3	LW1S-2C3V	—			
			Silver	SPDT	LW1S-2C5	—	—			
				DPDT	LW1S-2C6	—	LW1S-2C6M			
				3PDT	LW1S-2C7	—	—			
	45° 3-position Maintained		Gold	DPDT	LW1S-3C2	LW1S-3C2V	LW1S-3C2M			
				3PDT	LW1S-3C3	LW1S-3C3V	—			
				DPDT	LW1S-3C6	—	LW1S-3C6M			
			Silver	3PDT	LW1S-3C7	—	—			
Round with Square Bezel LW3S  				90° 2-position Maintained		Gold	SPDT	LW3S-2C1	LW3S-2C1V	—
							DPDT	LW3S-2C2	LW3S-2C2V	LW3S-2C2M
	3PDT	LW3S-2C3	LW3S-2C3V				—			
	Silver	SPDT	LW3S-2C5			—	—			
		DPDT	LW3S-2C6			—	LW3S-2C6M			
		3PDT	LW3S-2C7			—	—			
	45° 3-position Maintained		Gold	DPDT	LW3S-3C2	LW3S-3C2V	LW3S-3C2M			
				3PDT	LW3S-3C3	LW3S-3C3V	—			
				DPDT	LW3S-3C6	—	LW3S-3C6M			
			Silver	3PDT	LW3S-3C7	—	—			

Contact Operation

Operation Type	Contact	Operator Position and Contact Position (Top View)		
		Left	Center	Right
 90° 2-Position Maintained	SPDT		—	
	DPDT		—	
	3PDT		—	
 45° 3-position Maintained	DPDT			
	3PDT			

ø22 LW Series Selector Switches

Key Selector Switches (2-Position)



Shape	Operation Type	Key retained at ●	Contact Material	Contact	Type No.			
					Solder/Tab Terminal	PC Board Terminal	Screw Terminal	
Round LW1K-2  	90° 2-position Maintained	A	○	Gold	SPDT	LW1K-2C1A	LW1K-2C1VA	—
					DPDT	LW1K-2C2A	LW1K-2C2VA	LW1K-2C2MA
					3PDT	LW1K-2C3A	LW1K-2C3VA	—
			Silver	SPDT	LW1K-2C5A	—	—	
				DPDT	LW1K-2C6A	—	LW1K-2C6MA	
				3PDT	LW1K-2C7A	—	—	
		B	○	Gold	SPDT	LW1K-2C1B	LW1K-2C1VB	—
					DPDT	LW1K-2C2B	LW1K-2C2VB	LW1K-2C2MB
					3PDT	LW1K-2C3B	LW1K-2C3VB	—
			Silver	SPDT	LW1K-2C5B	—	—	
				DPDT	LW1K-2C6B	—	LW1K-2C6MB	
				3PDT	LW1K-2C7B	—	—	
		C	●	Gold	SPDT	LW1K-2C1C	LW1K-2C1VC	—
					DPDT	LW1K-2C2C	LW1K-2C2VC	LW1K-2C2MC
					3PDT	LW1K-2C3C	LW1K-2C3VC	—
			Silver	SPDT	LW1K-2C5C	—	—	
				DPDT	LW1K-2C6C	—	LW1K-2C6MC	
				3PDT	LW1K-2C7C	—	—	
Round with Square Bezel LW3K-2  	90° 2-position Maintained	A	○	Gold	SPDT	LW3K-2C1A	LW3K-2C1VA	—
					DPDT	LW3K-2C2A	LW3K-2C2VA	LW3K-2C2MA
					3PDT	LW3K-2C3A	LW3K-2C3VA	—
			Silver	SPDT	LW3K-2C5A	—	—	
				DPDT	LW3K-2C6A	—	LW3K-2C6MA	
				3PDT	LW3K-2C7A	—	—	
		B	○	Gold	SPDT	LW3K-2C1B	LW3K-2C1VB	—
					DPDT	LW3K-2C2B	LW3K-2C2VB	LW3K-2C2MB
					3PDT	LW3K-2C3B	LW3K-2C3VB	—
			Silver	SPDT	LW3K-2C5B	—	—	
				DPDT	LW3K-2C6B	—	LW3K-2C6MB	
				3PDT	LW3K-2C7B	—	—	
		C	●	Gold	SPDT	LW3K-2C1C	LW3K-2C1VC	—
					DPDT	LW3K-2C2C	LW3K-2C2VC	LW3K-2C2MC
					3PDT	LW3K-2C3C	LW3K-2C3VC	—
			Silver	SPDT	LW3K-2C5C	—	—	
				DPDT	LW3K-2C6C	—	LW3K-2C6MC	
				3PDT	LW3K-2C7C	—	—	

- Key is retained in ● position and removable in ○ position.
- Two keys are supplied.
- Key cylinder face (plastic): Black

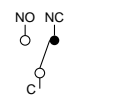
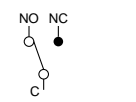
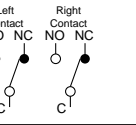
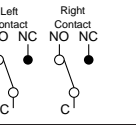
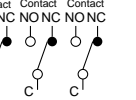
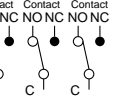
Contact Operation

Operation Type	Contact	Operator Position and Contact Position (Top View)	
		Left	Right
L 90° 2-Position Maintained R	SPDT		
	DPDT		
	3PDT		

Key Selector Switches (3-Position)

Shape	Operation Type	Key Retained at ●	Contact Material	Contact	Type No.				
					Solder/Tab Terminal	PC Board Terminal	Screw Terminal		
Round LW1K-3  	45° 3-position Maintained	A	●	Gold	DPDT	LW1K-3C2A	LW1K-3C2VA	LW1K-3C2MA	
				Silver	3PDT	LW1K-3C3A	LW1K-3C3VA	—	
			○	Gold	DPDT	LW1K-3C6A	—	LW1K-3C6MA	
				Silver	3PDT	LW1K-3C7A	—	—	
			B	●	Gold	DPDT	LW1K-3C2B	LW1K-3C2VB	LW1K-3C2MB
					Silver	3PDT	LW1K-3C3B	LW1K-3C3VB	—
		○		Gold	DPDT	LW1K-3C6B	—	LW1K-3C6MB	
				Silver	3PDT	LW1K-3C7B	—	—	
		C		●	Gold	DPDT	LW1K-3C2C	LW1K-3C2VC	LW1K-3C2MC
					Silver	3PDT	LW1K-3C3C	LW1K-3C3VC	—
			○	Gold	DPDT	LW1K-3C6C	—	LW1K-3C6MC	
				Silver	3PDT	LW1K-3C7C	—	—	
			D	●	Gold	DPDT	LW1K-3C2D	LW1K-3C2VD	LW1K-3C2MD
					Silver	3PDT	LW1K-3C3D	LW1K-3C3VD	—
		○		Gold	DPDT	LW1K-3C6D	—	LW1K-3C6MD	
				Silver	3PDT	LW1K-3C7D	—	—	
		E		●	Gold	DPDT	LW1K-3C2E	LW1K-3C2VE	LW1K-3C2ME
					Silver	3PDT	LW1K-3C3E	LW1K-3C3VE	—
			○	Gold	DPDT	LW1K-3C6E	—	LW1K-3C6ME	
				Silver	3PDT	LW1K-3C7E	—	—	
			G	●	Gold	DPDT	LW1K-3C2G	LW1K-3C2VG	LW1K-3C2MG
					Silver	3PDT	LW1K-3C3G	LW1K-3C3VG	—
		○		Gold	DPDT	LW1K-3C6G	—	LW1K-3C6MG	
				Silver	3PDT	LW1K-3C7G	—	—	
H	●	Gold		DPDT	LW1K-3C2H	LW1K-3C2VH	LW1K-3C2MH		
		Silver		3PDT	LW1K-3C3H	LW1K-3C3VH	—		
	○	Gold	DPDT	LW1K-3C6H	—	LW1K-3C6MH			
		Silver	3PDT	LW1K-3C7H	—	—			

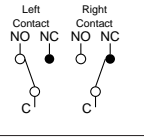
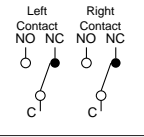
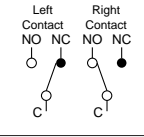
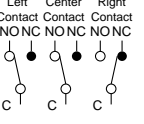
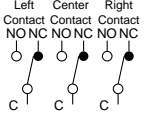
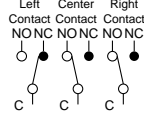

- Key is retained in ● position and removable in ○ position.
- Two keys are supplied.
- Key cylinder face (plastic): Black

Contact Operation

Operation Type	Contact	Operator Position and Contact Position (Top View)		
		Left	Center	Right
45° 3-position Maintained 	DPDT			
	3PDT			

ø22 LW Series Selector Switches

Key Selector Switches (3-Position)

Shape	Operation Type	Key Retained at ●	Contact Material	Contact	Type No.			
					Solder/Tab Terminal	PC Board Terminal	Screw Terminal	
Round with Square Bezel LW3K-3  	45° 3-position Maintained	A	Gold	DPDT	LW3K-3C2A	LW3K-3C2VA	LW3K-3C2MA	
				3PDT	LW3K-3C3A	LW3K-3C3VA	—	
				Silver	DPDT	LW3K-3C6A	—	LW3K-3C6MA
			3PDT	LW3K-3C7A	—	—		
			B	Gold	DPDT	LW3K-3C2B	LW3K-3C2VB	LW3K-3C2MB
					3PDT	LW3K-3C3B	LW3K-3C3VB	—
		Silver			DPDT	LW3K-3C6B	—	LW3K-3C6MB
		3PDT		LW3K-3C7B	—	—		
		C		Gold	DPDT	LW3K-3C2C	LW3K-3C2VC	LW3K-3C2MC
					3PDT	LW3K-3C3C	LW3K-3C3VC	—
			Silver		DPDT	LW3K-3C6C	—	LW3K-3C6MC
			3PDT	LW3K-3C7C	—	—		
			D	Gold	DPDT	LW3K-3C2D	LW3K-3C2VD	LW3K-3C2MD
					3PDT	LW3K-3C3D	LW3K-3C3VD	—
		Silver			DPDT	LW3K-3C6D	—	LW3K-3C6MD
		3PDT		LW3K-3C7D	—	—		
		E		Gold	DPDT	LW3K-3C2E	LW3K-3C2VE	LW3K-3C2ME
					3PDT	LW3K-3C3E	LW3K-3C3VE	—
			Silver		DPDT	LW3K-3C6E	—	LW3K-3C6ME
			3PDT	LW3K-3C7E	—	—		
			G	Gold	DPDT	LW3K-3C2G	LW3K-3C2VG	LW3K-3C2MG
					3PDT	LW3K-3C3G	LW3K-3C3VG	—
		Silver			DPDT	LW3K-3C6G	—	LW3K-3C6MG
		3PDT		LW3K-3C7G	—	—		
H	Gold	DPDT		LW3K-3C2H	LW3K-3C2VH	LW3K-3C2MH		
		3PDT		LW3K-3C3H	LW3K-3C3VH	—		
		Silver	DPDT	LW3K-3C6H	—	LW3K-3C6MH		
	3PDT	LW3K-3C7H	—	—				

- Key is retained in ● position and removable in ○ position.
- Two keys are supplied.
- Key cylinder face (plastic): Black

Contact Operation

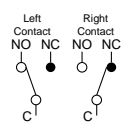
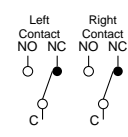
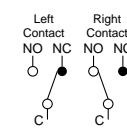
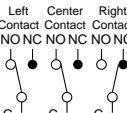
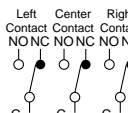
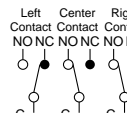
Operation Type	Contact	Operator Position and Contact Position (Top View)		
		Left	Center	Right
45° 3-position Maintained 	DPDT			
	3PDT			

Dimensions

• Selector Switch

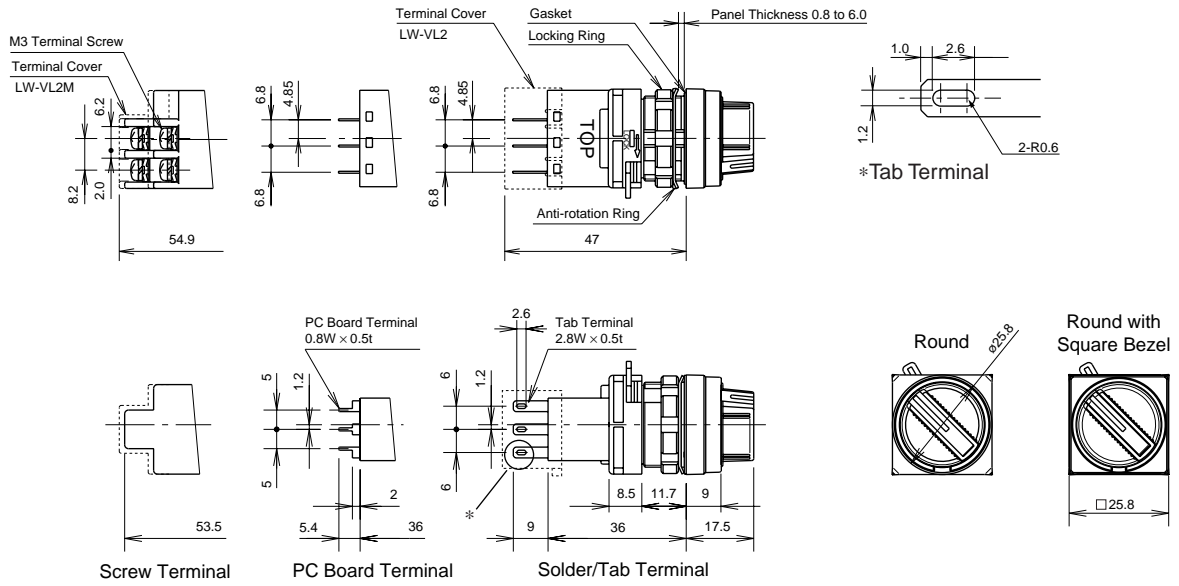

• Bottom View

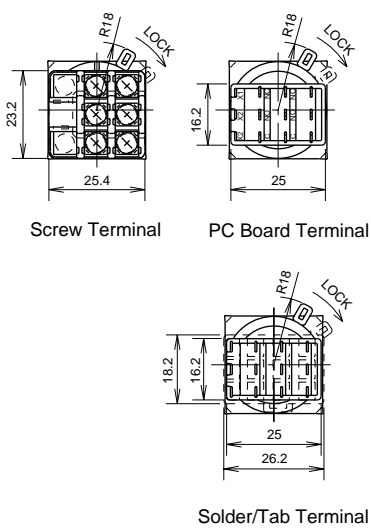

• Key Selector Switch

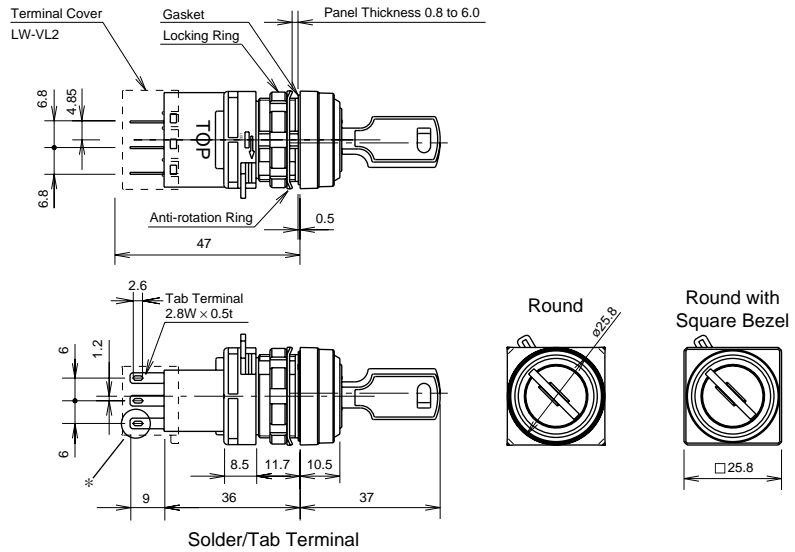

Terminal Arrangement (Bottom View)

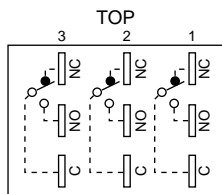

Note: SPDT has C, NO, and NC only in the center. DPDT has C, NO, and NC only on the right and left.

PC Board Drilling Layout (Bottom View)

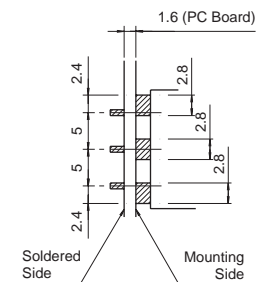
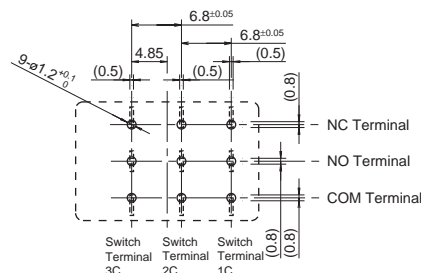



Pay attention to the pattern of the PC board as the terminals on the mounting surface are 2.8 mm wide.

All dimensions in mm.

ø22 LW Series Illuminated Selector Switches

Illuminated Selector Switches

Shape	Lamp	Operation Type	Contact Material	Contact	Type No.		
					Solder/Tab Terminal	PC Board Terminal	Screw Terminal
Round LW1F-2C LW1F-3C  Ⓡ Ⓢ ⓐ Ⓜ Ⓜ Ⓜ Ⓜ	LED	90° 2-position Maintained L R	Gold	SPDT	LW1F-2C1②③	LW1F-2C1③V②	—
				DPDT	LW1F-2C2③②	LW1F-2C2③V②	LW1F-2C2③M②
				3PDT	LW1F-2C3③②	LW1F-2C3③V②	—
			Silver	SPDT	LW1F-2C5③②	—	—
				DPDT	LW1F-2C6③②	—	LW1F-2C6③M②
				3PDT	LW1F-2C7③②	—	—
	LED	45° 3-position Maintained L C R	Gold	DPDT	LW1F-3C2③②	LW1F-3C2③V②	LW1F-3C2③M②
				3PDT	LW1F-3C3③②	LW1F-3C3③V②	—
				Silver	DPDT	LW1F-3C6③②	—
3PDT	LW1F-3C7③②	—	—				
Round with Square Bezel LW3F-2C LW3F-3C  Ⓡ Ⓢ ⓐ Ⓜ Ⓜ Ⓜ Ⓜ	LED	90° 2-position Maintained L R	Gold	SPDT	LW3F-2C1②③	LW3F-2C1③V②	—
				DPDT	LW3F-2C2③②	LW3F-2C2③V②	LW3F-2C2③M②
				3PDT	LW3F-2C3③②	LW3F-2C3③V②	—
			Silver	SPDT	LW3F-2C5③②	—	—
				DPDT	LW3F-2C6③②	—	LW3F-2C6③M②
				3PDT	LW3F-2C7③②	—	—
	LED	45° 3-position Maintained L C R	Gold	DPDT	LW3F-3C2③②	LW3F-3C2③V②	LW3F-3C2③M②
				3PDT	LW3F-3C3③②	LW3F-3C3③V②	—
				Silver	DPDT	LW3F-3C6③②	—
3PDT	LW3F-3C7③②	—	—				

• Color Code and Operating Voltage Code

② Lens/LED Color Code	③ Operating Voltage Code
Specify a Lens/LED color code in place of ② in the Type No. A: amber G: green R: red S: blue W: white Y: yellow	Specify an operating voltage code in place of ③ in the Type No. 2: 6V AC/DC 3: 12V AC/DC 4: 24V AC/DC

• Every illuminated selector switch contains an LED lamp (LSTD) of the specified color and voltage.

Dimensions

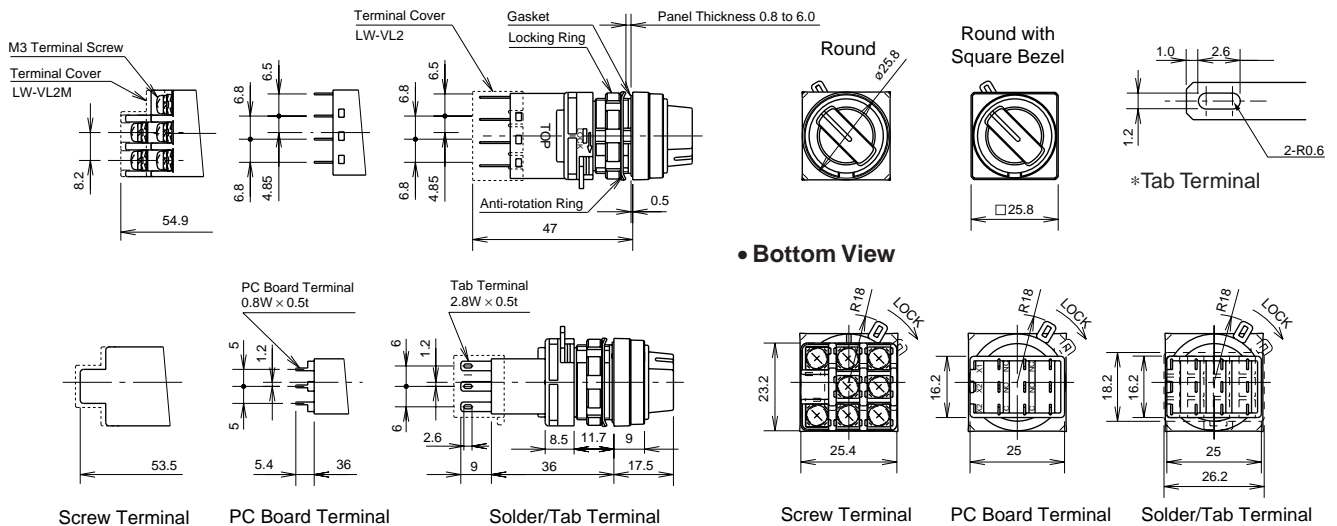

• For terminal arrangement and PC board dimensions, see page 12.



Buzzers

Continuous / intermittent (long) / intermittent (short) sounds can be selected with a built-in slide switch

- Collective mounting possible.
- Separate type control unit with locking lever, easy installation even when mounted collectively.
- Round and square types available.
- Solder/tab and PC board terminal types available.
- Single board mounting possible.
- Equipped with an LED indicator which lights (steady)/flashes with the buzzer sound.

Specifications

Insulation Voltage	60V AC/DC
Operating Voltage	6V, 12 to 24V AC/DC ±10%
Current Draw	DC: 7 mA, AC: 20 mA
Sound Pressure (at 0.1m)	Steady sound: 80 dB minimum (at the rated voltage)
Sound Frequency	2 kHz ±500Hz
Flickering Cycle	Slow intermittent sound: 55 cycles per minute ±10% Quick intermittent sound: 600 cycles per minute ±10%
Operating Temperature	-20 to +55°C (no freezing)
Operating Humidity	45 to 85% RH (no condensation)
Insulation Resistance	100 MΩ minimum (500V DC megger)
Dielectric Strength	Between live and metal parts: 1,000V AC, 1 minute
Vibration Resistance	Operating extremes: 5 to 55 Hz, amplitude 0.5 mm
Shock Resistance	Damage limits: 1,000 m/s ²
Life	1,000 hours minimum
Degree of Protection	IP40
Terminal Style	Solder/tab terminal no. 110 PC board terminal

Shape	Operating Voltage	LED	Type No.	
			Solder/Tab Terminal	PC Board Terminal
Round LW1Z 	6V AC/DC ±10%	Without	LW1Z-1X2	LW1Z-1X2V
		With	LW1Z-1X2D	LW1Z-1X2DV
	12 to 24V AC/DC ±10%	Without	LW1Z-1X4	LW1Z-1X4V
		With	LW1Z-1X4D	LW1Z-1X4DV
Square LW2Z 	6V AC/DC ±10%	Without	LW2Z-1X2	LW2Z-1X2V
		With	LW2Z-1X2D	LW2Z-1X2DV
	12 to 24V AC/DC ±10%	Without	LW2Z-1X4	LW2Z-1X4V
		With	LW2Z-1X4D	LW2Z-1X4DV

Dimensions

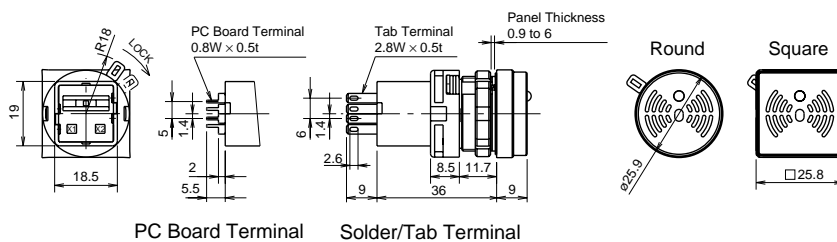

Terminal Arrangement (Bottom View)

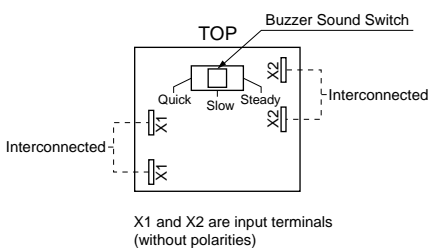

PC Board Layout (Bottom View)

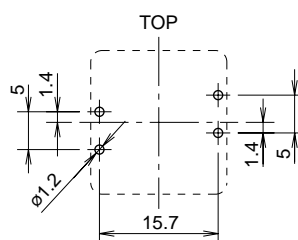



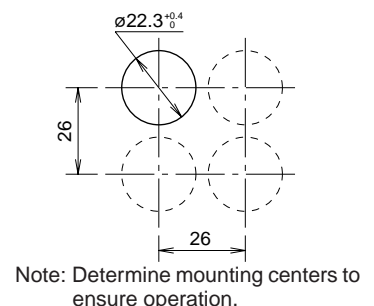







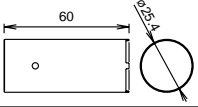



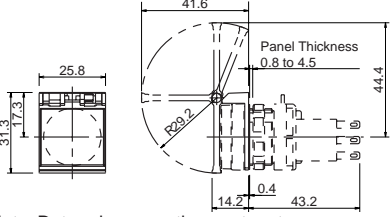

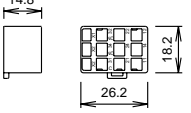
Panel Cut-out

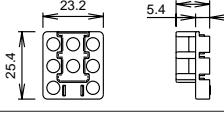

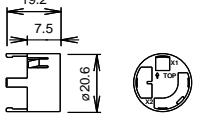

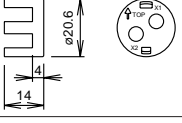

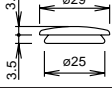
All dimensions in mm.

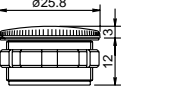
ø22 LW series Accessories and Replacement Parts













Accessories

Shape	Material	Type No. (Ordering Type No.)	Package Quantity	Dimensions (mm)
	Nickel-plated brass	LW9Z-T1	1	<ul style="list-style-type: none"> Used to tighten the locking ring when installing the LW control unit onto a panel. Tightening torque: 1.2 N-m 
	Rubber	OR-55	1	<ul style="list-style-type: none"> Used to install and remove LED lamps. 
	Spring Return Guard (polyarylate) Base (polyacetal)	LW9Z-K1	1	<ul style="list-style-type: none"> Used to protect flush pushbuttons and illuminated pushbuttons from inadvertent operation. Degree of protection: IP65.  <p>Note: Determine mounting centers to ensure easy operation.</p>
Maintained	LW9Z-K11	1		
	Plastic (translucent)	LW-VL2	1	<ul style="list-style-type: none"> For separate type control units only. 
	Plastic (black)	LW-VL2M	1	<ul style="list-style-type: none"> For separate type control units only. 
	Plastic (translucent)	LW-PVL	1	<ul style="list-style-type: none"> For unibody type pilot lights only. 
	Plastic (translucent)	LW-PVLM	1	<ul style="list-style-type: none"> For unibody type pilot lights only. 
	Nitril rubber (black)	OB-31PN05	5	<ul style="list-style-type: none"> Degree of protection: IP65 
	Metal (diecast) Locking nut (plastic)	LW9Z-BM	1	<ul style="list-style-type: none"> Degree of protection: IP66 Panel thickness: 0.8 to 6 mm 

Maintenance Parts

Shape	For Use On	Material	Type No.	Ordering Type No.	Package Quantity	Color Code
	Round Flush	Polyarylate	LW9Z-L1②	LW9Z-L1②PN05	5	Specify a lens color code in place of ② in the Ordering Type No.
	Round Flush with Square Bezel					
	Round Extended	Polyarylate	LW9Z-L12②	LW9Z-L12②PN05	5	A: amber C: clear G: green R: red S: blue Y: yellow
	Square Flush	Polyarylate	LW9Z-L2②	LW9Z-L2②PN05	5	
	ø30mm Mushroom	AS	LW9Z-L13②	LW9Z-L13②	1	

Maintenance Parts

Shape	For Use On	Material	Type No.	Ordering Type No.	Package Quantity	Color Code	
Button 	Round Flush	Polyacetal	LW1A-B1①	LW1A-B1①PN05	5	Specify a button color code in place of ① in the Ordering Type No. B: black G: green R: red S: blue W: white Y: yellow	
	Round Flush with Square Bezel						
Button 	Extended	Polyacetal	LW1A-B2①	LW1A-B2①PN05	5		
	Round Extended with Square Bezel						
Button 	Square Flush	Polyacetal	LW2A-B1①	LW2A-B1①PN05	5		
Button 	Square Extended	Polyacetal	LW2A-B2①	LW2A-B2①PN05	5		
Button 	ø30mm Mushroom	AS	LW1A-B3①	LW1A-B3①	1		
Marking Plate 	Round	Acryl	LW9Z-P1W	LW9Z-P1WPN05	5		• White
	Round with Square Bezel						
Marking Plate 	Square	Acryl	LW9Z-P2W	LW9Z-P2WPN05	5		
Marking Plate 	Round Extended	Acryl	LW9Z-P12W	LW9Z-P12WPN05	5		
Marking Plate 	Mushroom	Acryl	ALW3B	ALW3BPN05	5		
Knob 	Illuminated Selector	Plastic	LW1A-F②	LW1A-F②	1	A (amber), G (green), R (red), S (blue), W (white), Y (yellow)	
Locking Ring 	All LW Control Units	Plastic	LW9Z-LN	LW9Z-LNPN05	5	• Black	
Anti-rotation Ring 	Selector Switch	Stainless Steel	LW9Z-L	LW9Z-LPN10	10		
Spare Key 	Key Selector Switch	Metal	KG9Z-SK-231	KG9Z-SK-231PN02	2		

LED Lamps

Operating Voltage	Current Draw		Type No.	Ordering Type No.	Illumination Color Code	Package Quantity	Base
	AC	DC					
6V AC/DC ±10%	17 mA (A, R, W, Y) 8 mA (G, S)	14 mA (A, R, W, Y) 5.5 mA (G, S)	LSTD-6②	LSTD-6②	Specify a color code in place of ② in the Ordering Type No.	1	BA9S/13
				LSTD-6②PN10		10	
12V AC/DC ±10%	11 mA	10 mA	LSTD-1②	LSTD-1②	A: amber G: green R: red S: blue W: white Y: yellow	1	
				LSTD-1②PN10		10	
24V AC/DC ±10%	11 mA	10 mA	LSTD-2②	LSTD-2②		1	
				LSTD-2②PN10		10	

Transformer

Separate Mounting Type	Primary Voltage	Secondary Voltage	Type No.
For 1W 	100/110V AC	5.5V AC	TWR516
	200/220V AC		TWR526
	400/440V AC		TWR546

Safety Precautions

- Turn off the power to the LW series control units before starting installation, removal, wiring, maintenance, and inspection of the products. Failure to turn power off may cause electrical shocks or fire hazard.
- To avoid burning your hand, use the lamp holder tool when replacing lamps.
- For wiring, use wires of a proper size to meet the voltage and current requirements. Solder correctly according to the instructions on "Wiring" and "Notes on Terminal Cover" on page 23. Tighten the M3 terminal screws to a torque of 0.6 to 1.0 N·m. Failure to tighten terminal screws may cause overheating and fire.

Instructions

Panel Mounting

Remove the contact block from the operator. Insert the operator into the panel cut-out from the front, then install the contact block.

• Removing the Contact Block

Turn the locking lever on the contact block in the direction opposite to the arrow on the housing. Then the contact can be removed.

• Installing the Contact Block

Insert the contact block, with the TOP markings on the contact block and the operator placed in the same direction. Then lock the units, turning the locking lever in the direction of the arrow.

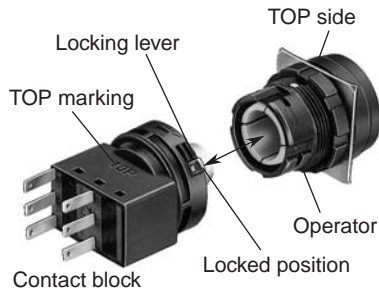

• Notes on Mounting

Use the optional ring wrench (LW9Z-T1) to mount the operator onto the panel. Tightening torque should not exceed 1.2 N·m. Do not use pliers. Excessive tightening will damage the locking ring.

• Collective Mounting

As the locking lever can be turned easily from the rear of the units using a screwdriver, the contact blocks can be removed even when mounted collectively.

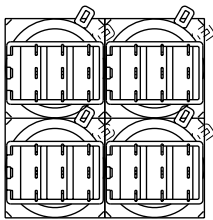

Replacement of Lens and Marking Plate

• Removing

1. Remove the operator (lens, marking plate, and lens holder) by inserting a screwdriver into the recess of the lens through the bezel.

[Removing the Operator]



2. Remove the marking plate by pushing the lens from the rear to disengage the latches between the lens and the lens holder, using the screwdriver as shown below.

[Removing the lens]



Note: The translucent filter in the lens holder cannot be removed because the filter is sealed to make the unit waterproof.

• Installing

For round lens types, place the marking plate on the lens holder with the anti-rotation projection engaged and press the lens onto the lens holder to engage the latches. For square lens types, insert the marking plate into the lens, and press the lens onto the holder to engage the latches.

Note: Make sure of correct orientation of the marking plate.

[Round Lens Type]

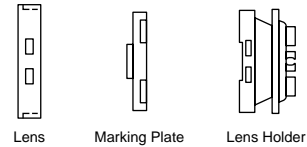

[Square Lens Type]

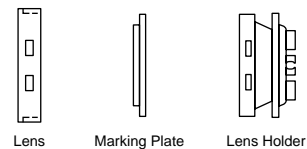

Marking Plate and Films

For LW series illuminated pushbuttons and pilot lights, legends and symbols can be engraved on the marking plates, or printed marking film can be inserted under the lens for labelling purposes.

• Marking Plate and Marking Film Size

Lens	Round Lens	Square Lens
Built-in Marking Plate	<p>Engraving Area ø17.8 0.85</p> <ul style="list-style-type: none"> • Engraving must be made on the engraving area within 0.5mm deep. • The marking plate is made of white acrylic resin. 	<p>Engraving Area 17.5 17.5 0.8</p>
Applicable Marking Film	<p>19.8 17.7</p> <ul style="list-style-type: none"> • Two 0.1mm-thick films or one 0.2mm-thick film can be installed in the lens. • Marking film is not included. • Recommended marking film: Polyester film 	<p>19.8</p>

Instructions

• Insertion Order of Marking Plate and Film

[Round Lens Type]

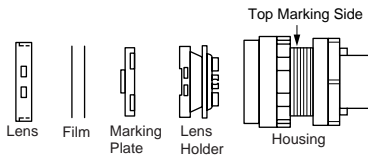

• Note: Film is not included

[Square Lens Type]

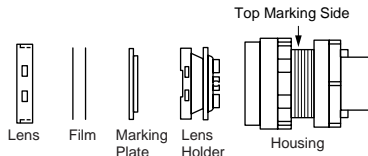

• Note: Film is not included
Make sure of correct orientation of the marking plate.

Replacement of Lamps

Lamps can be replaced using the lamp holder tool (OR-55) from the front of the panel, or by removing the contact block from the operator.

• How to Remove

To remove, slip the lamp holder tool onto the lamp head. Then push slightly, and turn the lamp holder tool counter-clockwise.



Lamp Holder Tool
OR-55



• How to Install

1. To install, insert the lamp head into the lamp holder tool, and hold the lamp as shown in the figure below.

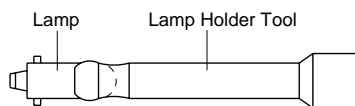

2. Insert the pins on the lamp base into the grooves in the lamp socket. Insert the lamp and turn it clockwise.

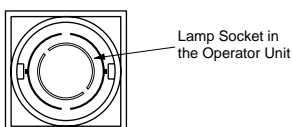

Wiring

1. Solder the terminals within 20W/5 sec or 260°C/3 sec without exerting external force to the terminals. While soldering, do not touch the soldering iron to the housing. While wiring, prevent tension from being applied to the terminals. Do not bend or raise the terminals, nor exert excessive force to terminals.
2. Use non-corrosive liquid flux.
3. For tab terminals, Positive Lock Connectors and Easy Lock Connectors can be used.
4. Tighten the terminal screw of the screw terminal type to a torque of 0.6 to 1.0 N·m.

Notes on Terminal Cover

[Solder/Tab Terminal]

Insert the terminal cover into the contact block with the TOP markings on the contact block and the terminal cover in the same direction.

Note: When wiring, insert the lead wires into the terminal cover holes before soldering.



• Notes on Wiring

When installing a terminal cover onto the solder/tab terminal contact block, solder the inside of lamp terminal (toward the switch terminals) and wire.

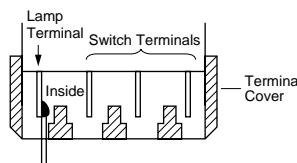

[Screw Terminal Type]

Terminal cover must be installed on the control unit before wiring.

Note 1: After wiring, terminal covers cannot be installed.

Note 2: When terminal covers are installed, do not use round crimping terminals.

(Wire the terminal by using fork terminals or lead wires directly.)

Single Board Mounting

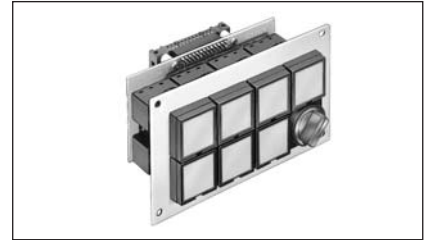

Mounting the control units on a single PC board offers the following features.

1. Reduced installation labor, easy wiring, space saving, and standardization.
2. Since the contact blocks on the PC board can be removed easily using a locking lever, LW series control units are easy to maintain.
3. Because the LW series control units require no studs for fastening the control unit to a PC board, special preparation of operation panel is not needed.
4. For details on single board mounting, contact IDEC.

Specifications and other descriptions in this catalog are subject to change without notice.



IDEC IZUMI CORPORATION

7-31, Nishi-Miyahara 1-Chome, Yodogawa-ku, Osaka 532-8550, Japan
Tel: +81-6-6398-2571, Fax: +81-6-6392-9731
www.idec.com

IDEC CORPORATION (USA)

1175 Elko Drive, Sunnyvale, CA 94089-2209, USA
Tel: +1-408-747-0550, Toll Free: (800) 262-IDECE, Fax: +1-408-744-9055
E-mail: opencontact@idec.com, www.idec.com

IDEC CANADA LIMITED

Unit 22-151, Brunel Road Mississauga, Ontario, L4Z 1X3, Canada
Tel: +1-905-890-8561, Toll Free: (888) 317-4332, Fax: +1-905-890-8562

IDEC ELECTRONICS LIMITED

Unit 2, Beechwood, Chineham Business Park, Basingstoke, Hampshire
RG24 8WA, UK
Tel: +44-1256-321000, Fax: +44-1256-327755

E-mail: idec@uk.idec.com

IDEC ELEKTROTECHNIK GmbH

Wendenstrasse 331, D-20537 Hamburg, Germany
Tel: +49-40-25 30 54 10, Fax: +49-40-25 30 54 24
E-mail: service@idec.de, www.idec.de

IDEC AUSTRALIA PTY. LTD.

2/3 Macro Court, Rowville, Victoria 3178, Australia
Toll Free: 1-800-68-4332, Fax: +61-3-9763-3255
E-mail: sales@au.idec.com

IDEC IZUMI ASIA PTE. LTD.

No. 31, Tannery Lane #05-01, Dragon Land Building, Singapore 347788
Tel: +65-6746-1155, Fax: +65-6844-5995
E-mail: generalinfo@idecasia.com.sg

IDEC IZUMI (H.K.) CO., LTD.

Unit 1505-07, DCH Commercial Centre No. 25, Westlands Road,
Quarry Bay, Hong Kong
Tel: +852-2803-8989, Fax: +852-2565-0171
E-mail: idec@idechk.com

IDEC IZUMI (Shanghai) Co., Ltd.

Room E, 15F, Majesty Building, No. 138 Pudong Avenue,
Shanghai 200120, P.R.C.
Tel: +86-21-5887-9181, Fax: +86-21-5887-8930
E-mail: idec@cn.idec.com

IDEC TAIWAN CORPORATION

8F, No. 79, Hsin Tai Wu Road, Sec. 1, Hsi-Chih, Taipei County, Taiwan
Tel: +886-2-2698-3929, Fax: +886-2-2698-3931
E-mail: service@idectwn.com.tw