

DG Series — Easy to Read Large Character Display

Compact 0.314" (8mm) Wide
Available in 3 Operator Styles
Choice of 6 Output Codes

Key features of the DG series include:

- Standard size, dustproof construction
- Glass-epoxy PC boards for reliability, long life
- Easy to read large character display 0.27"H x 0.13"W (7mm x 3.4mm)
- Units available in three operator styles: set-lock, dual button, and thumbwheel
- Variety of output codes: 2-position repeat, decimal, BCD, complementary BCD, hexadecimal, and duodecimal
- Solder mount terminals
- Easy to assemble snap-fit construction
- A stop mechanism can be incorporated to restrict wheel rotation to user-defined limits; see page C-22 for instructions on how to specify the stop mechanism in the part number designation



C

Specifications	Front Size (H x W)	1.287" x 0.314" (33 x 8mm)
	Character Size (H x W)	Decimal unit: 0.273" x 0.133" (7 x 3.4mm)
	Operator Style	Set-lock, dual button, and thumbwheel
	Assembly Method	Snap-fit
	Mounting Method	Snap-fit
	Housing Color	Black
	Character Color	White characters on black background
	Terminal Style	Solder
	Output	2-position repeat, decimal, binary coded decimal (BCD), duodecimal, and hexadecimal setting, and complementary BCD
	Connector Types	Solder
	Operating Voltage	50V AC, 28V DC
	Operating Current	0.1A (resistive load)
	Thermal Current	1A (non-switching)
	Dielectric Strength	Between live and dead parts: 1,000V AC, 1 minute Between live parts: 500V AC, 1 minute
	Insulation Resistance	Between live and dead parts: 1,000MΩ min Between live parts: 10MΩ min
	Contact Resistance	200mΩ maximum
Vibration Resistance	50m/sec ² (approximately 5G) maximum	
Shock Resistance	100m/sec ² (approximately 10G) maximum	
Life Expectancy (operations)	Electrical: 100,000 minimum Mechanical: 1,000,000 minimum	
Operating Temperature	-20 to +60°C (do not freezing)	

Part Numbers

Part Numbers: DG Series

Operator Style	Output Code	Part No.	Comments
Set-lock	2-position repeat	DGAN-001-B	—
		DGAN-001D-B*	Connecting diodes
	Decimal	DGAN-010-B	—
	BCD	DGAN-031-B	—
		DGAN-031D-B*	Connecting diodes
		DGAN-031P-B	Odd parity
	Complementary BCD	DGAN-131-B	—
	Duodecimal	DGAN-032-B	—
		DGAN-032D-B*	Connecting diodes
	Hexadecimal	DGAN-036-B	—
DGAN-036D-B*		Connecting diodes	
Thumbwheel	2-position repeat	DGCN-001-B	—
		DGCN-001D-B*	Connecting diodes
	Decimal	DGCN-010-B	—
	BCD	DGCN-031-B	—
		DGCN-031D-B*	Connecting diodes
	DGCN-031P-B	Odd parity	
Complementary BCD	DGCN-131-B	—	
Dual button	2-position repeat	DGBN-001-B	—
		DGBN-001D-B*	Connecting diodes
	Decimal	DGBN-010-B	—
	BCD	DGBN-031-B	—
		DGBN-031D-B*	Connecting diodes
		DGBN-031P-B	Odd parity
	Complementary BCD	DGBN-131-B	—
	Duodecimal	DGBN-032-B	—
		DGBN-032D-B*	Connecting diodes
	Hexadecimal	DGBN-036-B	—
DGBN-036D-B*		Connecting diodes	

DG Series

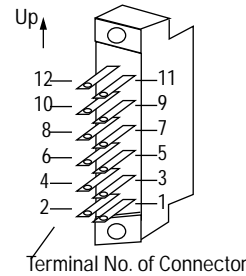

5. The DG series has connector terminals. The terminal numbers of the switch do not coincide with those of the connector.



- * Extended PC boards for installing diodes. Diodes must be purchased separately.
- For dimensions, see page C-19.
- For output codes, see page C-12.
- For terminal arrangements, see page C-21.

Accessories

Part Numbers: DG Series Accessories

Description	Used On	Part No.
Spare Unit	DGAN, DGBN	DGNY-1-B
	DGCN	DGCY-1-B
Connector	With solder terminals	DMC-1
	With PC board terminals	DMC-2



Description	Used On	Part No.
End Plate (in pairs)	DGAN, DGBN 0.078" (2mm) thick	DGNW-1-B
	DGCN 0.078" (2mm) thick	DGCW-1-B
	DGAN, DGBN 0.156" (4mm) thick	DGNW-2-B
	DGCN 0.156" (4mm) thick	DGCW-2-B

Output Codes

2-Position Repeat Unit

Do not connect any wiring to the unused terminals.

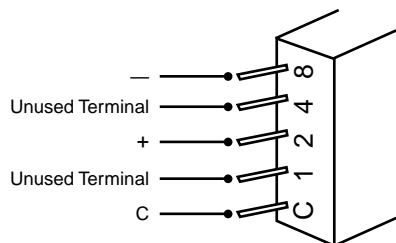

		Contact Condition		
Code No.		C	+	-
Contact Configuration and Switch Unit				
Terminal No.		C	0	1
Connector Terminal No.	DL	-	-	-
	DE	-	-	-
	DF	7	9	5
	DG	6	4	8
Preset Position	+		•	
	-			•
	+		•	
	-			•
	+		•	
	-			•
	+		•	
	-			•
	+		•	
	-			•

Applicable Units

DL series (001)
DE series (001)
DF series (001)
DG series (001)

BCD (Binary Coded Decimal)

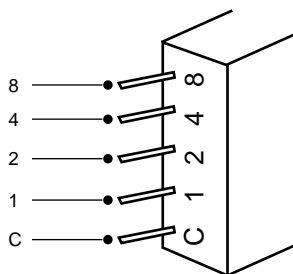

		Contact Condition				
Code No.		C	1	2	4	8
Contact Configuration and Switch Unit						
Terminal No.		C	1	2	4	8
Connector Terminal No.	DL	-	-	-	-	-
	DE	-	-	-	-	-
	DF	7	11	9	5	3
	DG	6	2	4	8	10
Preset Position	0					
	1		•			
	2			•		
	3		•	•		
	4				•	
	5		•		•	
	6				•	•
	7		•	•	•	
	8					•
	9		•			•

Applicable Units

DL series (431)
DE series (031)
DF series (031)
DG series (031)

Complementary BCD

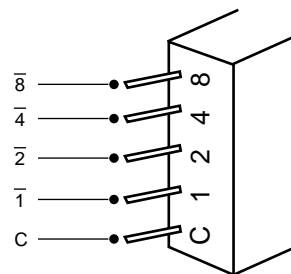

		Contact Condition				
Code No.		C	1	2	4	8
Contact Configuration and Switch Unit						
Terminal No.		C	1	2	4	8
Connector Terminal No.	DL	-	-	-	-	-
	DF	7	11	9	5	3
	DG	-	-	-	-	-
Preset Position	0		•	•	•	•
	1			•	•	•
	2		•		•	•
	3				•	•
	4		•	•		•
	5			•		•
	6		•			•
	7					•
	8		•	•	•	
	9			•	•	

Applicable Units

DF series (131)
DG series (131)

Output Codes, continued

Decimal

Code No.		Contact Condition										
		C	0	1	2	3	4	5	6	7	8	9
Contact Configuration and Switch Unit												
Terminal No.		C	0	1	2	3	4	5	6	7	8	9
Connector Terminal No.	DE	—	—	—	—	—	—	—	—	—	—	—
	DF	6	11	10	9	8	7	5	4	3	2	1
	DG	6	2	3	4	5	7	8	9	10	11	12
Preset Position	0		•									
	1			•								
	2				•							
	3					•						
	4						•					
	5							•				
	6								•			
	7									•		
	8										•	
	9											•

Applicable Units

DE series (010)
DF series (010)
DG series (010)



The DL and DE series do not have connector terminals. The DF and DG series have connector terminals.

BCD with Odd Parity

Code No.		Contact Condition					
		C	1	2	4	8	P
Contact Configuration and Switch Unit							
Terminal No.		C	1	2	4	8	P
Connector Terminal No.	DF	7	11	9	5	3	1
	DG	6	2	4	8	10	12
Preset Position	0						•
	1		•				
	2			•			
	3		•	•			•
	4				•		
	5		•		•		•
	6			•	•		•
	7		•	•	•		
	8					•	
	9		•			•	•

Applicable Units

DF series (031P)
DG series (031P)



Output Codes, continued

Duodecimal

Code No.		Contact Condition				
		C	1	2	4	8
Contact Configuration and Switch Unit						
Terminal No.		C	1	2	4	8
Connector Terminal No.	DF	7	11	9	5	3
	DG	6	2	4	8	10
Preset Position		0				
		1	•			
		2		•		
		3	•	•		
		4			•	
		5	•		•	
		6		•	•	
		7	•	•	•	
		8				•
		9	•			•
		10		•		•
		11	•	•		•

Applicable Units

DF series (032)
DG series (032)

Hexadecimal

Code No.		Contact Condition				
		C	1	2	4	8
Contact Configuration and Switch Unit						
Terminal No.		C	1	2	4	8
Connector Terminal No.	DF	7	11	9	5	3
	DG	6	2	4	8	10
Preset Position		0				
		1	•			
		2		•		
		3	•	•		
		4			•	
		5	•		•	
		6		•	•	
		7	•	•	•	
		8				•
		9	•			•
		A		•		•
		B	•	•		•
		C			•	•
		D	•		•	•
		E		•	•	•
		F	•	•	•	•

Applicable Units

DF series (036)
DG series (036)

C

Dimensions and Mounting Hole Layouts

DL Series

Front Mount 0.195" (5mm) Wide

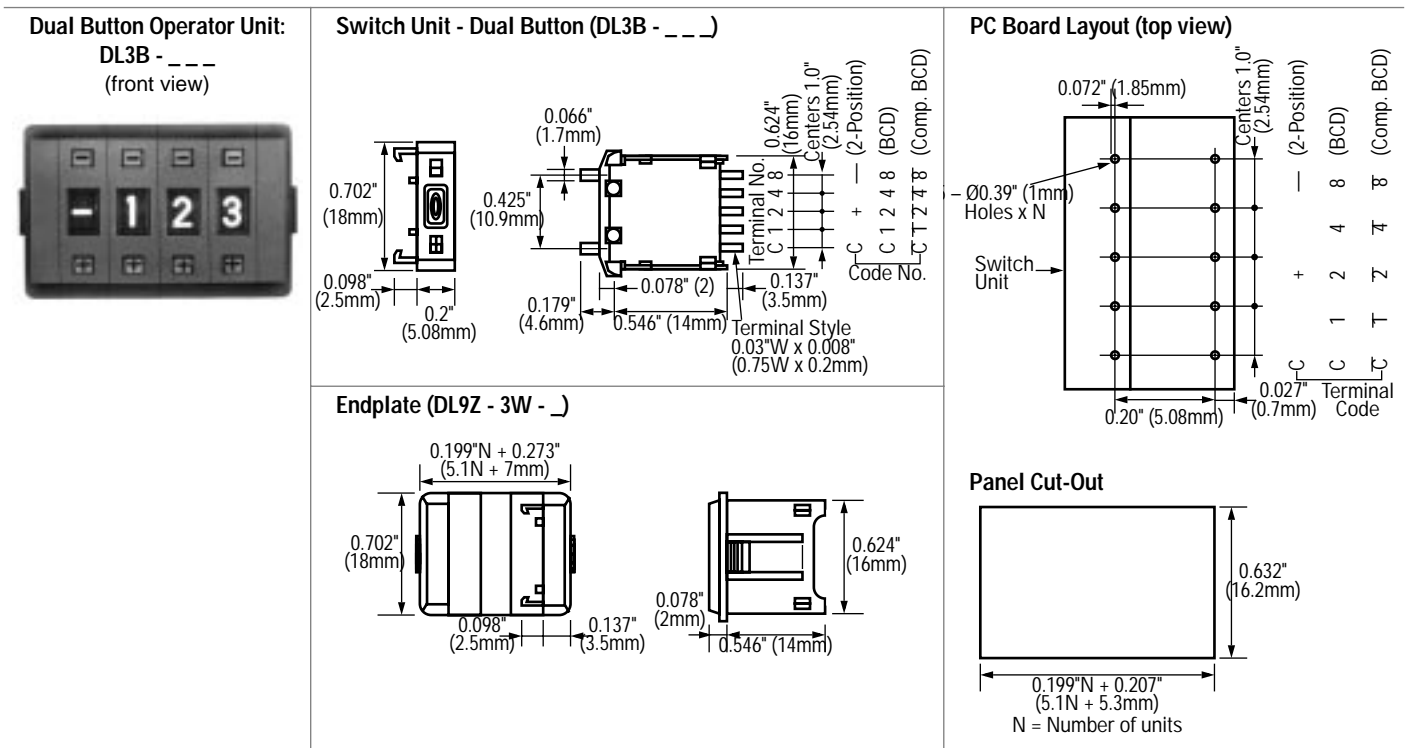
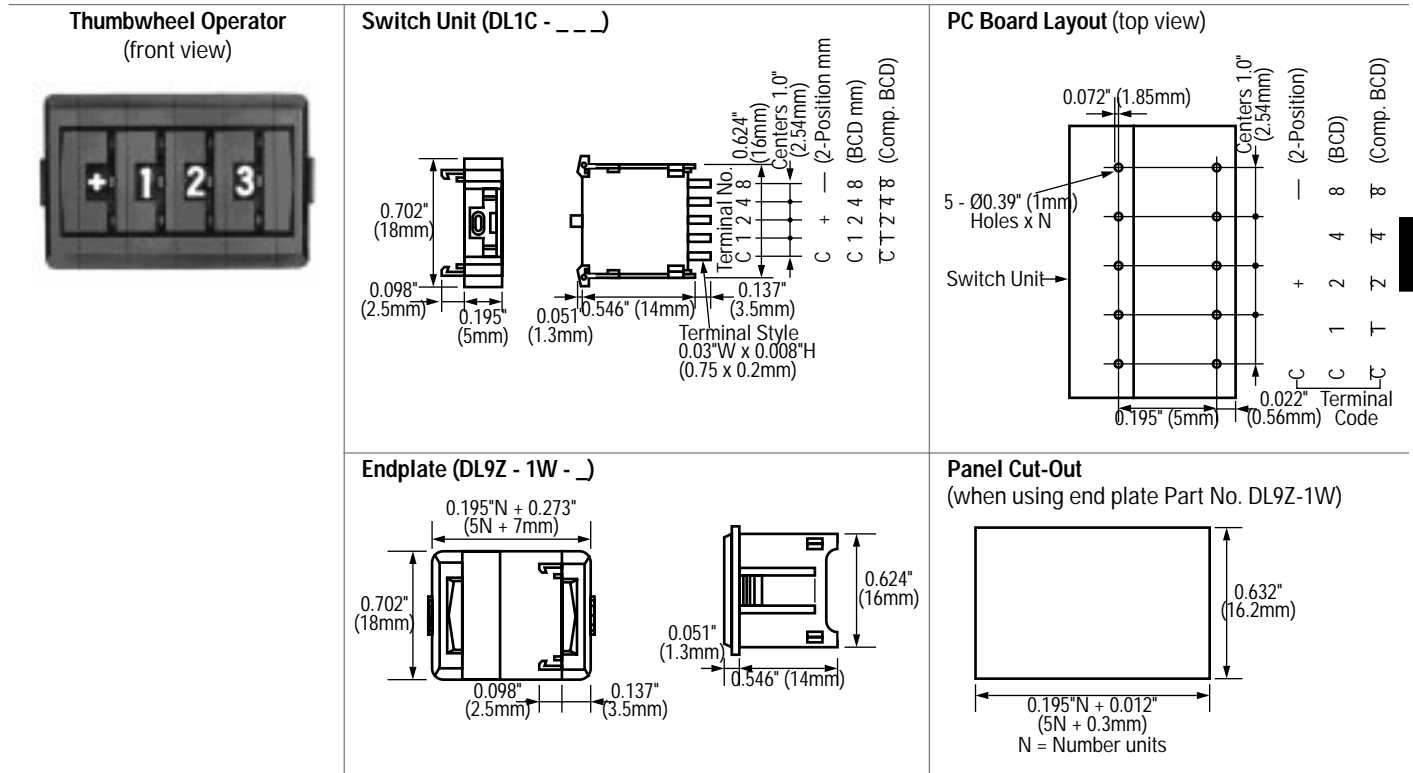

1. N=The number of switch and spare units. Panel thickness = 0.078" (2mm).

2. The width of the panel cut-out applies to a maximum of 10 switch units mounted (including spare units).

Dimensions and Mounting Hole Layout, continued

DL Series

Front Mount 0.234" (6mm) Wide

**Dual Button Operator Unit:
DL5B - ____**
(front view)



Switch Unit – Dual Button (DL5B - ____)

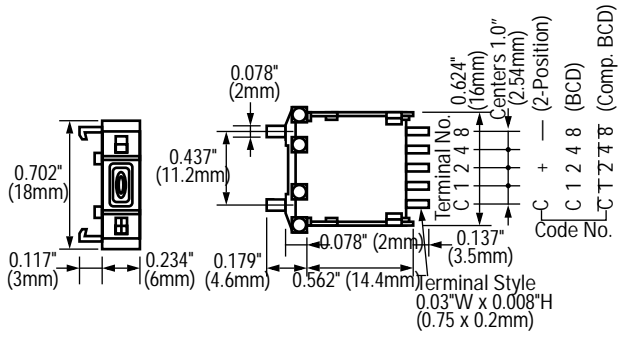

PC Board Layout (top view)

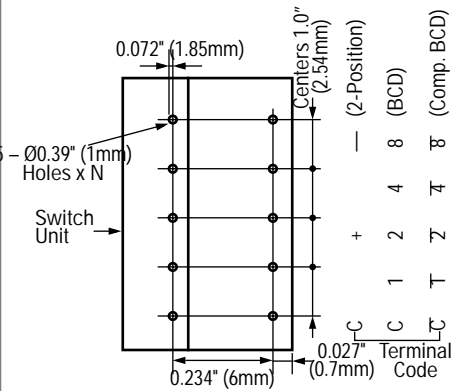

Enplate (DL9Z - 5W - _)

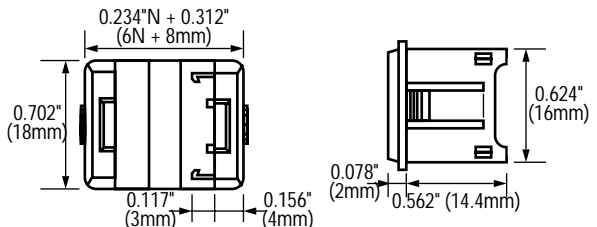

Panel Cut-Out
(when using end plate Part No. DL9Z-5W)

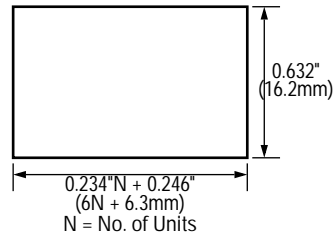

1. N = the number of switch and spare units. Panel thickness = 0.078" (2mm).
2. The width of the panel cut-out applies to a maximum of 10 switch units mounted (including spare units).

Dimensions and Mounting Hole Layout, continued

DE Series

Front Mount 0.234" (6mm) Wide

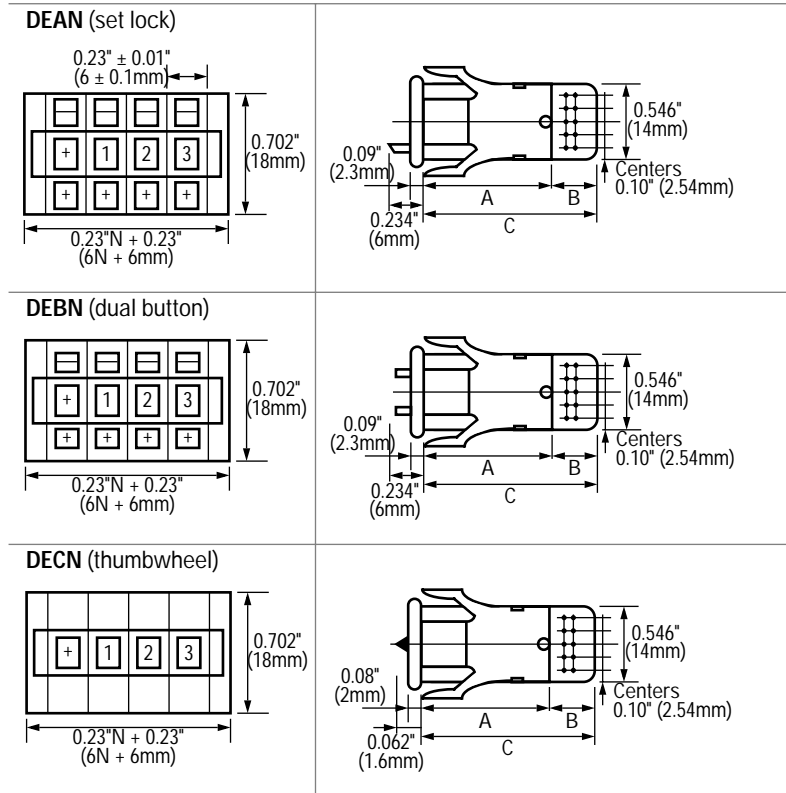

Front Mount (DE _)

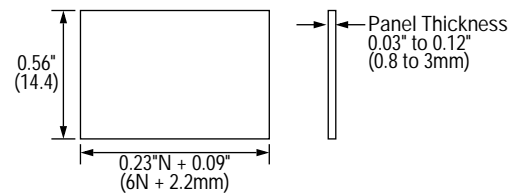

Panel Cut-Out Dimensions (DE)

	Standard	With Diode Extension
A	0.59" (15mm)	0.66" (16mm)
B	0.312" (8mm)	0.74" (18.5mm)
C	0.9" (23mm)	1.4" (34.5mm)
D	0.9" (23mm)	1.3" (33.5mm)



N = the number of switch units and spare units mounted, excluding endplates.



Dimensions and Mounting Hole Layout, continued

DF Series

DFAN (set-lock)

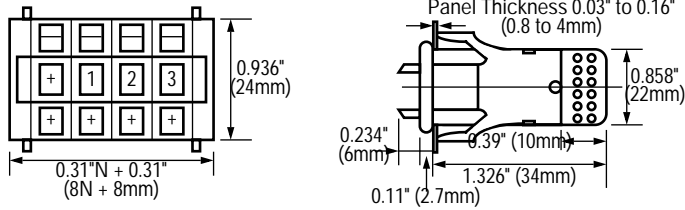

Panel Cut-Out Dimensions (DF)

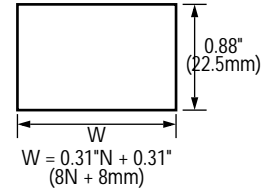

N = Number of Units

C

DFBN (dual button) 0.312" (8mm)

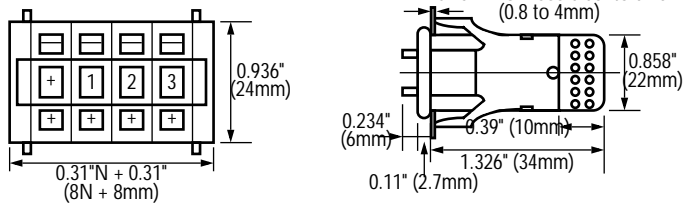

DFCN (thumbwheel) 0.312" (8mm)

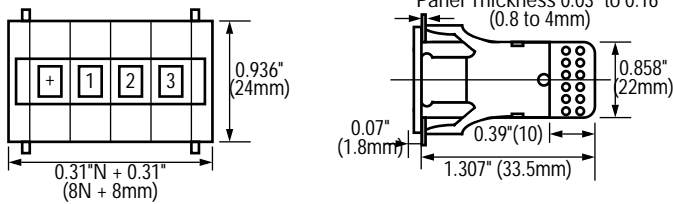

N = the number of switch units and spare units mounted, excluding endplates.

Solder Terminal (switch unit)

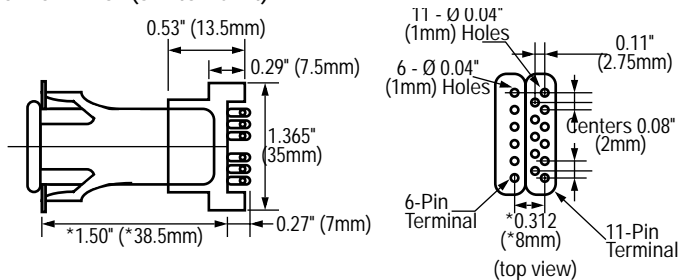

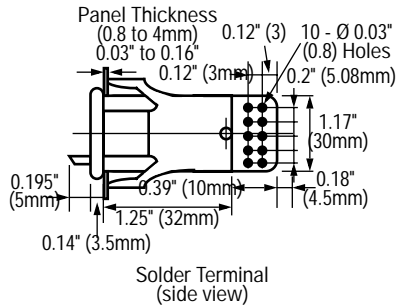
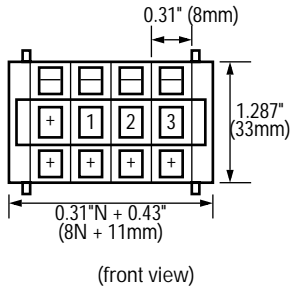
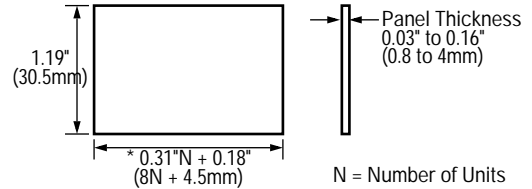
Dimensions and Mounting Hole Layout, continued
DG Series)
DGAN (set-lock)

Panel Cut-Out

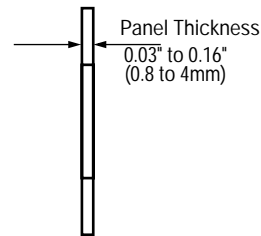
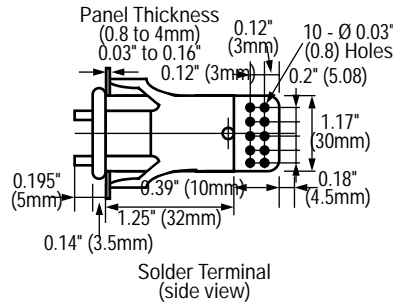
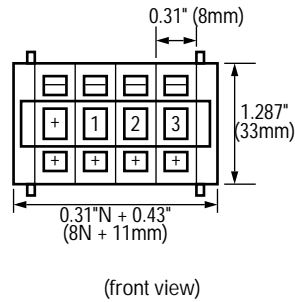
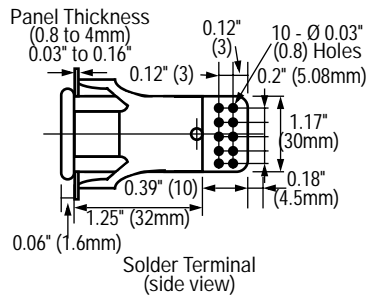
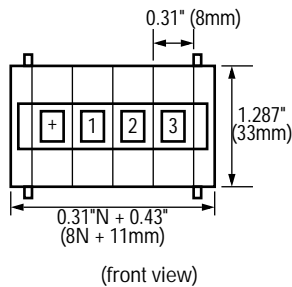
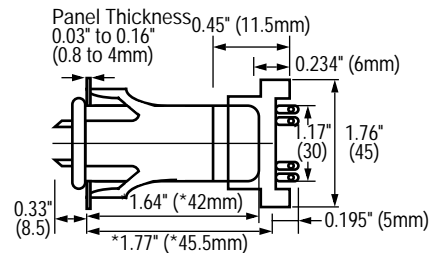
*When using End Plates DGNW-1 or DGCW-1
 **When using End Plates DGNW-2 or DGCW-2

DGBN (dual button)

DGCN (thumbwheel)

Solder Terminal Connector Dimensions

The width of the panel cut-out applies to a maximum of 10 switch units mounted (including spare units).

DE Terminal Arrangements

DF Terminal Arrangements

Dimensions in inches (mm).

Dimensions in inches (mm).

2-Position Repeat

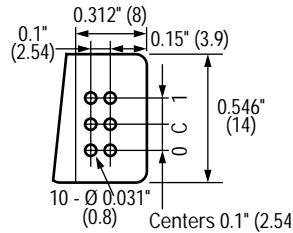

Decimal Unit

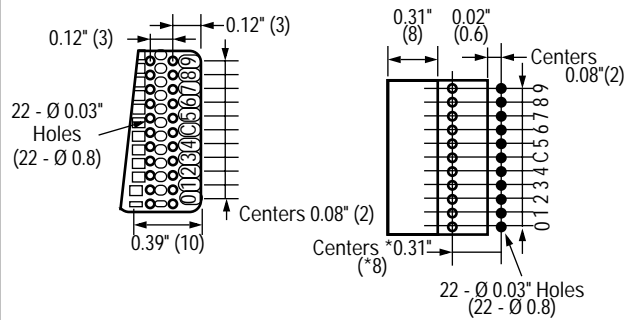

BCD

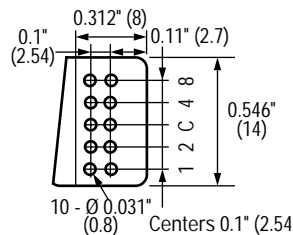

BCD with Odd Parity

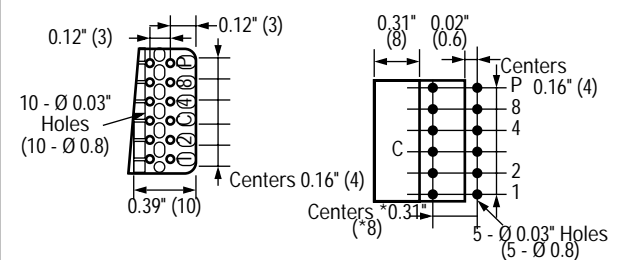

BCD with Connecting Diodes

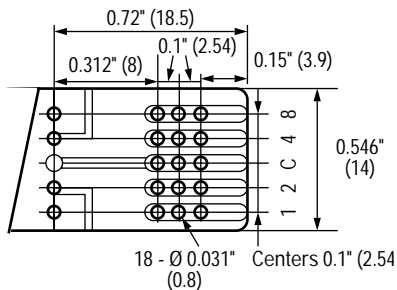

BCD with Connecting Diodes

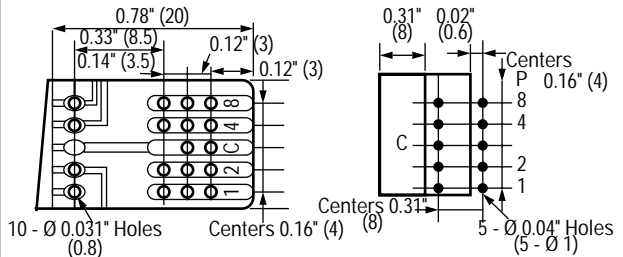

Decimal

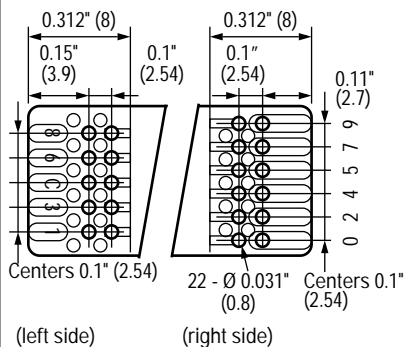

2-Position Repeat

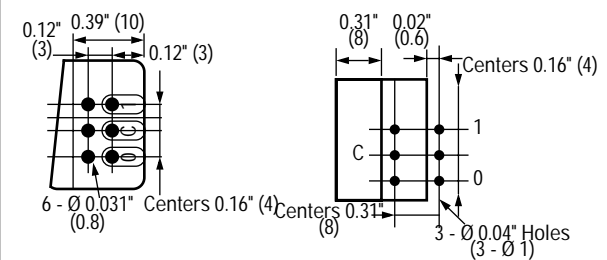

DG Terminal Arrangements

Dimensions in inches (mm).

<p>2-Position Repeat — Diode Connection</p>	
<p>2-Position Repeat</p>	
<p>Decimal</p>	
<p>BCD, Duodecimal, Hexadecimal (diode connection)</p>	
<p>BCD, Duodecimal, Hexadecimal</p>	



General Instructions

Instructions

With the dual button units, the lower button is for incrementing and the upper button is for decrementing. Rotating the thumbwheel down increments the number, and rotating the thumbwheel up decrements the number.

Set-Lock Type

The button should be made accessible only when rotating the thumbwheel. Return the button to the recessed position when not used to prevent inadvertent actuation.

Installation and Maintenance

C Since the units snap together with hooks, no hardware is necessary for assembly. When mounting the switches into a panel cut-out, hold the assembly at the end plates and insert it from the front of the panel.

Use rubbing alcohol to clean the surfaces of the switch units, the soldered parts on the terminals, and the other molded parts. Do not use thinner or acids. Make sure that no solvent enters the switch housing.

When soldering, prevent the soldering flux and detergent from entering the switch housing.

To disassemble the switch units in the DL series, pull the units apart from the front. When using a flat screwdriver to disassemble, insert the screwdriver under the latch and turn gently.

Specifying Units with a Stop Mechanism

Example: Digital switch units with a stop mechanism to restrict wheel rotation within 0 and 3:

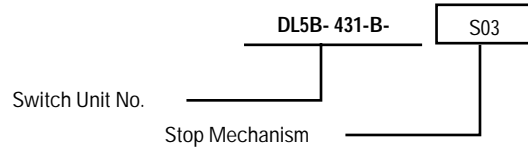

A stop mechanism can be actuated to restrict wheel rotation within 9 positions; -S09 or -S10 is not available. The wheel cannot be prevented from rotating between adjoining positions such as between 0 and 1 or between 9 and 0.

Ordering Information

When ordering, specify the part numbers and quantity of the switch units and accessories as shown in the following examples.

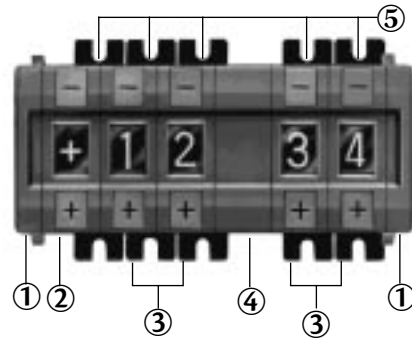

Specification Examples, Mounted Units

Unit	Item	Part No.	Qty. Req'd	Qty. in Pkg.
①	End plates	DL9Z-5W-B	2	2
②	Switch unit	DL5B-001-B	1	1
③	Switch unit	DL5B-431-B	3	1
④	Spare unit	DL9Z-5Y-B	1	1

Specification Examples, DFAN Assembly

Unit	Item	Part No.	Qty. Req'd	Qty. in Pkg.
①	End plates	DFNW-1-B	2	2
②	Switch unit	DFAN-001-B	1	1
③	Switch unit	DFNY-1-B	1	1
④	Spare unit	DFAN-031-B	4	1
⑤	Connector	DAC-061	5	1