



# **MC88C**

## **Safety magnetic sensors**

**Instruction manual**

**Manuale d'istruzione**

**Betriebsanleitung**

**Manuel d'instructions**

**Manual de instrucciones**

**Brugervejledning**

**使用手册**



# Table of contents

<b>1. Introduction</b>	<b>5</b>
<b>2. Product description</b>	<b>6</b>
<b>3. Mounting and mechanical dimensions</b>	<b>7</b>
<b>4. Operating mode</b>	<b>7</b>
<b>5. Installation</b>	<b>8</b>
<b>6. Operating and alignment direction</b>	<b>9</b>
<b>7. Electrical connections</b>	<b>10</b>
<b>8. Maintenance and disposal</b>	<b>11</b>
<b>9. Technical data</b>	<b>12</b>
9.1 Electrical data	12
9.2 Outputs	12
9.3 Actuating characteristics	12
9.4 Switching distances	12
9.5 Environmental conditions	12
9.6 Approvals / tests	12
9.7 Safety classification	13
9.8 Mechanical data	13
9.9 Cable version	13
9.10 Plug version	13
9.11 Pigtail version	13

# MC88C safety magnetic sensors - Instruction manual

## Ownership

Copyright © 2020, CARLO GAVAZZI Industri. All rights reserved in all countries.

CARLO GAVAZZI reserves the right to modify or make improvements to this document without advance notice.

## Safety messages

The following symbols are used in this document to indicate warning concerning the user and/or the safety device:



**Warning:** indicates actions that if not observed may lead to damage to the device.



**Attention:** only CARLO GAVAZZI technical service personnel are authorized to open the safety device.

## General information



**Note:** This manual should be consulted for all situations related to installation and use. It must be kept in good condition and in a clean location accessible to all operators.

## Service and warranty

In the event of malfunction or requests for information please contact the CARLO GAVAZZI branch or distributor in your country.

# 1. Introduction

This user manual must be read and understood completely, prior to carrying out any operation on the MC88CH safety sensors, by personnel dealing with all the activities related to the sensors.

All the operations described in this manual must be carried out exclusively by specialized personnel carefully following all the indications given.

## Ordering code

This user manual applies to the following types:

Code	Option	Description
<b>M</b>	-	Magnetic
<b>C</b>	-	Rectangular size
<b>88</b>	-	88mm length
<b>C</b>	-	Plastic
<b>H</b>	-	Reed contact
<input type="checkbox"/>	<b>2O</b>	Contacts: 2 normally open
	<b>1O1C</b>	Contacts: 1 normally open and 1 normally closed
	<b>2O1C</b>	Contacts: 2 normally open and 1 normally closed
<input type="checkbox"/>	<b>L</b>	Left exit
	<b>R</b>	Right exit
<input type="checkbox"/>	<b>A2</b>	Connection type: PVC cable 2m
	<b>M5</b>	Connection type: M8 integrated connector
	<b>T1</b>	Connection type: pig tail with M12 connector
<input type="checkbox"/>	<b>Null</b>	No LED
	<b>L</b>	With LED indicator

## Magnetic actuator

**MC88CM1 (5mm)**

**MC88CM2 (8mm)**

**MC88CM3 (18mm)**



**Note:** the technical data of this manual are applicable also to the MC88CH models with different cable length. The special products, that are products having a cable length which varies with regards to the standard models, will be identified by one or 2 numbers after the letter "A" in the code. Example: MC88CH2OL with 2 x NO contacts, left exit, without LED and with a cable of 5 meter long: MC88CH2OLA5.

## 2. Product description

The MC88CH safety sensor features one or more reed contacts that are activated without contact through the coded magnetic field of the actuator MC88CM.

The MC88CH safety sensors are suited for gate/door monitoring applications and can reach PL e, safety category 4 according to EN ISO 13849-1.

The sensors are only a subset of the safety-related parts of the machine: the safety level of the entire system depends also on all the other safety components and devices of the system set.

As application example, if a door is opened, the actuator moves away from the sensor which is positioned on the stationary part of the guard.

If the new position of the actuator reaches the safe switch-off distance (Sar), the switching status can be communicated to a connected safety relay.

The sensors have onboard N.O. and/or N.C. safety contacts, operated when the corresponding MC88CM actuator is close to the sensor.

All the MC88CH/MC88CM pairs described in this manual make up a multiple flow redundant Type 4 coded system with low-level coding, as defined in the standard EN ISO 14119. The design of the MC88CH sensors and of the MC88CM actuators results in MC88CH/MC88CM pairs which cannot be easily operated by readily available instruments, increasing the safety level of the application.

The user is responsible for the risks evaluation of the safety system; he decides with complete responsibility if the products described in the user manual are suitable for his application.

The MC88CH/MC88CM sensors do not require internal maintenance: if they are tampered with, they lose their safety functions and the guarantee is annulled.



**Note:** the meanings of “Normally Open” and “Normally Closed” contact throughout this manual are the following:

N.O.: contact is open and non-conductive when sensor is not operated with actuator magnet MC88CM away from the sensor.

N.C.: contact is closed and conductive when sensor is not operated with actuator magnet MC88CM away from the sensor.

### 3. Mounting and mechanical dimensions

The MC88CH/MC88CM pairs can be mounted using the holes on both sides of the enclosure, suitable for M4 screws. It is recommended to use brass or non-magnetic steel screws to avoid reducing the operating distance of the sensor.

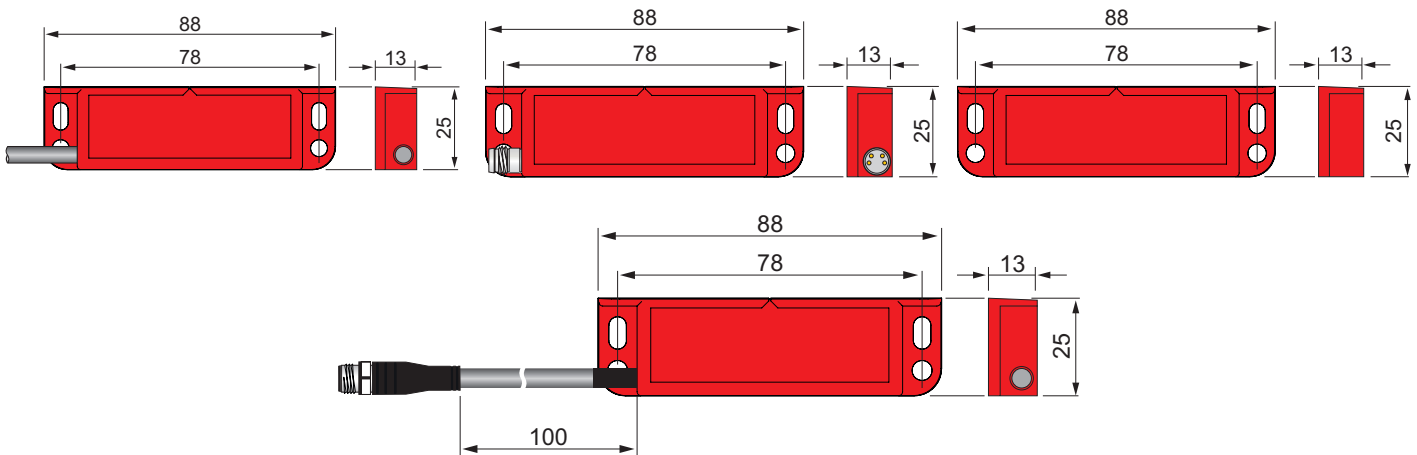

Fig. 1 - Dimensions

### 4. Operating mode

MC88CH sensor is "operated" when all its safety contacts have changed their open/close condition when the MC88CM actuator is close to the sensor (see section Technical Data for operating distances).

The magnetic coding of the MC88CH sensor requires magnet MC88CM to be correctly aligned with sensor to ensure correct functionality.

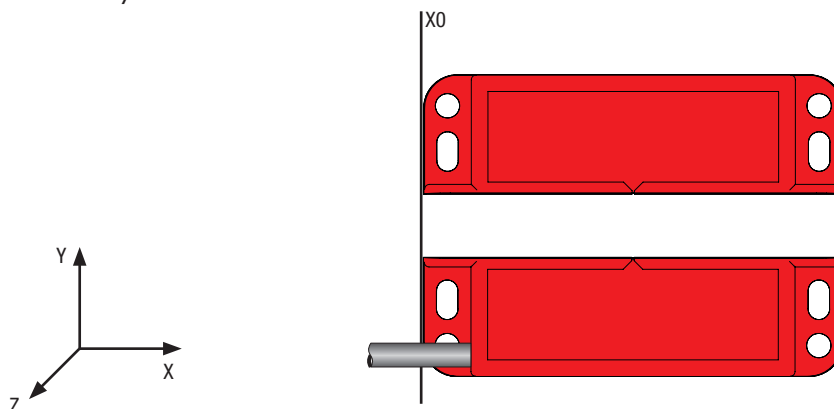

Fig. 2 - Operating and alignment direction of the sensors

The alignment is achieved moving the MC88CM actuator towards the MC88CH sensor along the X axis (side alignment, e.g. sliding door) or Y axis (frontal alignment e.g. hinged gate/door or slide) or perpendicularly to the XY plane (Z axis, e.g. hinged gate/door).

A correct alignment is achieved when the MC88CH sensor and the MC88CM actuator lay on the same XY plane, aligned to the same position X0 (see fig. 2).

In that position, if the Y distance between the sensor and the magnetic unit is less than the Operating Distance (Sao, see Technical Data), the sensor is correctly operated.

Different alignments can lead to wrong operating conditions (e.g. none or only one internal contact changes its status). It should always be the goal to achieve optimal alignment between sensor and magnet during installation. However the MC88CH does allow some misalignment while still keeping correct operation. The typical maximum allowed displacement between sensor and magnet in the XZ-plane can be seen in figure 3. Notice that any misalignment in this plane will reduce the switching distance in the Y-axis.

## 5. Installation

The MC88CM actuator must be mounted on the moving guard of the machine, and the MC88CH magnetic sensor must be fixed on a stationary part of the machine, by using two screws each (M4), on both sides of the enclosure.

All the screws and nuts must be properly blocked, in compliance with EN ISO 14119, e.g. by using self-locking screws, rivets or similar.

The position of the MC88CH sensors must avoid any possibility for the operator to reach dangerous parts of the machine. It must be difficult for operators to access to the safety switches when the guard is open, and they must be protected against tampering or unintentional switching.

The connections of all the MC88CH sensors are listed in tables 9.9 and 9.10; the pin-out of the connectorized models is shown in chapter 7.

Fitting the sensor and/or the actuator directly on ferromagnetic parts (or very close to ferromagnetic parts) would lead to a reduction of the operating distances.

It is recommended to use brass or non-magnetic fixing screws and to fit the sensor and/or the actuator on non-ferromagnetic parts.

If fitted on ferromagnetic material, it is necessary to place a non-ferromagnetic material (min. thickness of 6 mm) between the MC88CH/MC88CM pair and the ferromagnetic parts of the machine closest to them.

To avoid mutual interactions between different magnetic sensors, when using more than one pair of MC88CH/MC88CM in the same application, every pair of sensor-actuator must be placed at least 50 mm away from the adjacent sensor-actuator pair in any direction.

At the end of the installation, the machine installation procedure must be carried out to check for correct wiring and, in particular, to check that the machine stop time is less than the operator access to the machine time, once the guard is open.



**Note:** the MC88CH sensors with LED make available a signalling LED in series to the N.O. contact: this contact is not voltage free, but it is polarized; it needs and forces a voltage drop when not operated. If the wires are connected with the wrong polarity, the LED is permanently OFF (however the sensor still works properly).

ISO 14119:2013 standard states that the magnetic type of protection devices associated to the guard cannot be easily eluded through the use of easily available instruments or objects such as screws, nails, pieces of metal, keys and generally through objects or tools related to the normal machine working operations. Based on the indication of the standard, a multiple flow coded magnet, such as the MC88CH + MC88CM systems, is a device difficult to be eluded. Nevertheless, due to the impossibility of guaranteeing non elusion through any substituted magnetic actuator for the coded magnetic unit, the machine manufacturer must carry out an installation that includes mechanical obstacles which do not allow the insertion of a substitution actuator in front of the sensor (with the guard open).



### Attention:

- The MC88CH safety sensor and the MC88CM actuator must be installed according to the standards in force in the country of use, when the machine is not powered and with no danger for the operator.
- Mount the sensor and the actuator on a flat surface. Excessive shocks and vibrations, over the limits specified in the "Technical Data" section, must be avoided, otherwise proper function of the sensor cannot be guaranteed. The contacts have to be protected from overcurrents.
- It is recommended to keep the connection cables separate from power supply loads cables of other devices.
- Ensure that there are no conductors, cables or loose materials that can come into contact with the sensor and/or with the actuator.
- Ensure that the conductors are not excessively tight, that their positioning avoids potential cuts or squashing and that they are not in the way of people or things.
- Ensure that the machine can operate according to all the technical data in this manual.
- Avoid using the sensor and the actuator as mechanical backstop and avoid installation during storms. Do not dispose of the packaging in the environment.
- Maximum current must be limited by external circuit (e.g. with a resistor in series with the sensor wires)



## 6. Operating and alignment direction

In case of horizontal and vertical misalignment between the sensor and the actuator, the sensor remains active within the tolerance range.

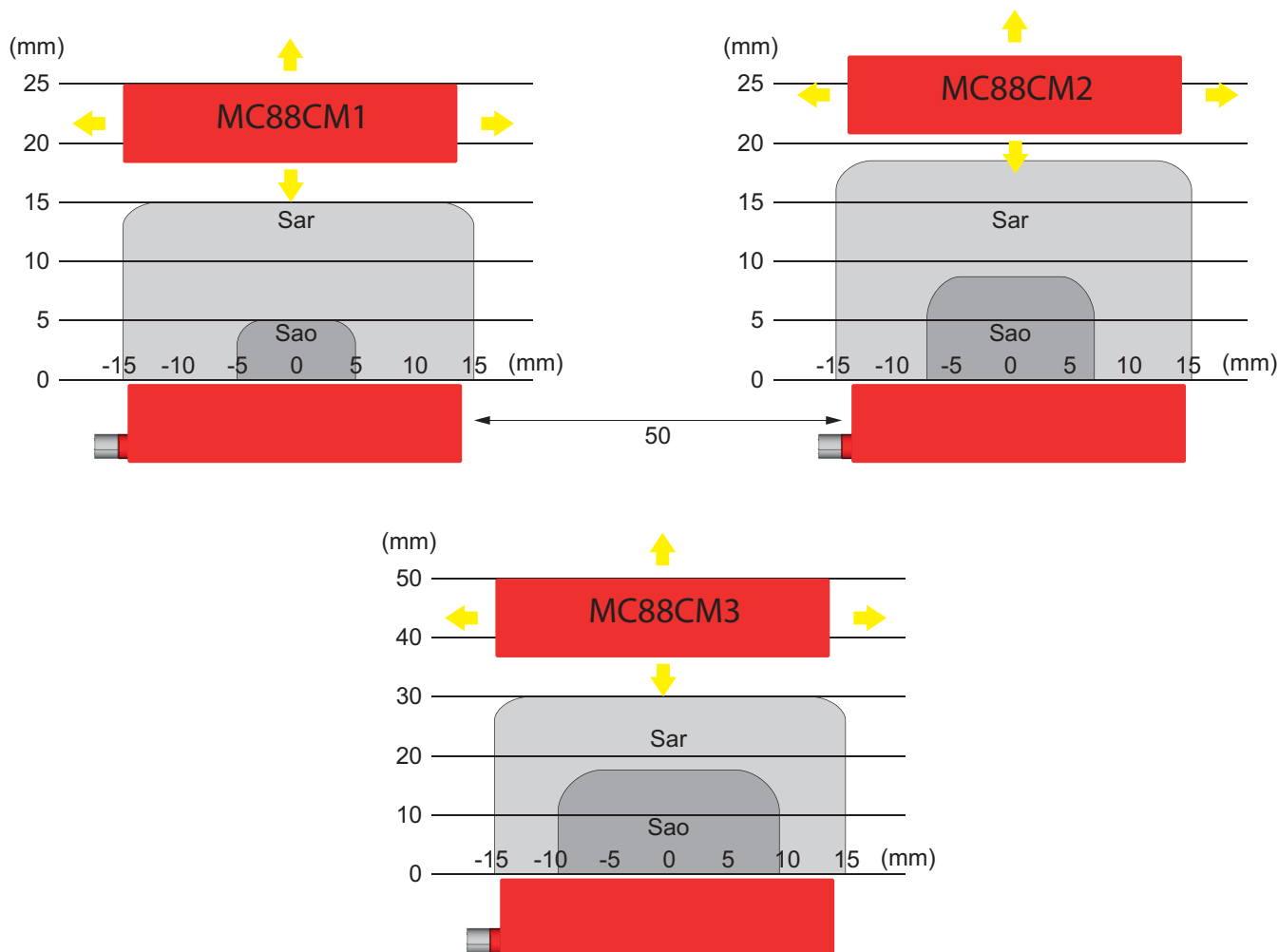

**Fig. 3** - Distance

The Assured switching distance  $S_{ao}$  is the one in which all safety contacts have switched their status.  
The Assured switch-off distance  $S_{ar}$  is the one in which, when the actuator moves away from the sensor, all safety contacts have released and return to the rest position.



**Note:** the typical detection characteristic shown in Fig. 3 may vary from sensor to sensor.

## 7. Electrical connections

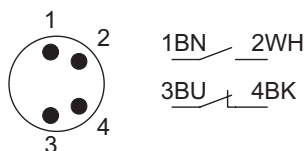

1NC + 1NO, plug M8

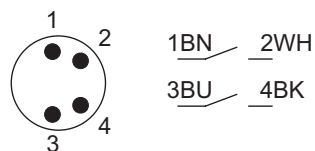

2NO, plug M8

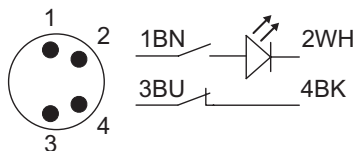

1NC + 1NO, plug M8 with LED

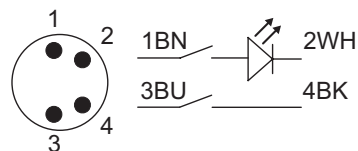

2NO, plug M8 with LED

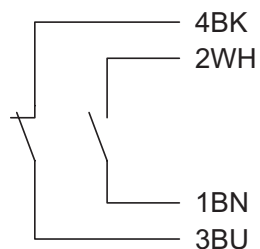

1NC + 1NO, cable

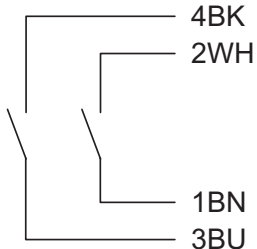

2NO, cable

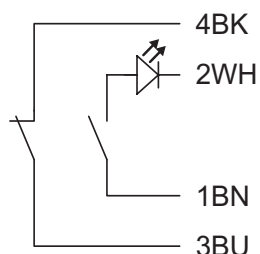

1NC + 1NO, cable with LED

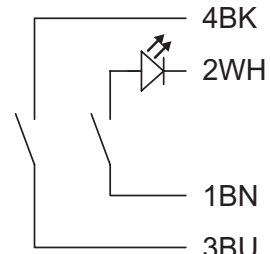

2NO, cable with LED

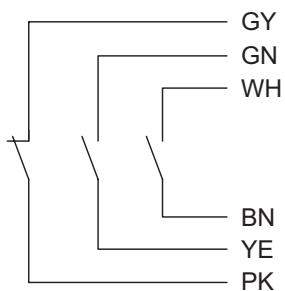

1NC + 2NO, cable

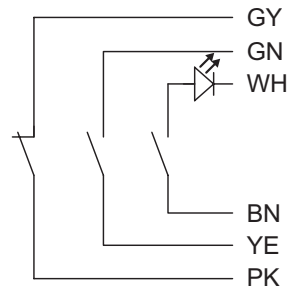

1NC + 2NO, cable with LED

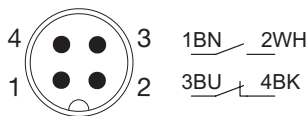

1NC + 1NO, M12

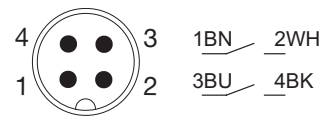

2NO, M12

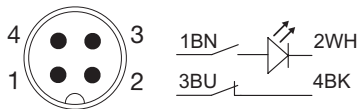

1NC + 1NO, M12 with LED

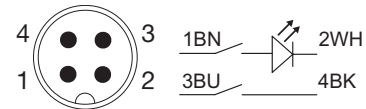

2NO, M12 with LED



**Warning:** when sensor contacts are used without the related safety modules, installer should ensure that external circuit limits the maximum load current to no more than 250 mA, e.g. with a resistor in series with the sensor wires.

## 8. Maintenance and disposal

The integrity of the MC88CH/MC88CM sensors and all the parts connected to them must be checked regularly by specialized personnel. It must be possible to inspect and replace the safety switches, by qualified personnel only. Keep the spare actuators in a safe place.

The frequency of the inspections is part of the machine risks evaluation and it is under the complete responsibility of the person in charge of such evaluations.

Operator safety can be compromised by the lack of regular inspections or maintenance, or if they are carried out incorrectly, or by non specialized personnel, or at lower intervals than prescribed.

Regular inspections consist of carrying out an inspection of the wiring, of the installation, of the tightening and of the integrity of the MC88CH/MC88CM pair, and in repeating, for each sensor / actuator pair, all the operations concerning the machine start-up procedure.

Maintenance consists of a regular cleaning of the sensor and the actuator and of all the connected devices: dust and other substances must be removed from the devices and it must be dried of liquids or any condensation.

All cleaning operations must be carried out whilst the machine is rigorously not powered.

Dispose of the device in accordance with the national environmental regulations when it is no longer used.



**Warning:** The operating time of the device is restricted to T10D.  
After that period, the device must be replaced.  
T10D=B10D/Nop (refer to EN ISO 13849-1)

## 9. Technical data

All the distances involved are referred to a sample MC88CM device, with MC88CH/MC88CM pairs mounted far away from other magnetic parts or devices, and with MC88CH frontally operated (see Fig. 2).

### 9.1 Electrical data

<b>Rated operational voltage U<sub>e</sub></b>	12-24 V AC/DC
<b>Rated insulation voltage U<sub>i</sub></b>	Cable version / M12: 120 Vac M8 connector version: 60 Vac / 75 Vdc
<b>Rated impulse withstand voltage U<sub>imp</sub> Line-to-ground (1.2/50 µs) R<sub>i</sub> 500 Ω</b>	6 kV / 1.5 kV (with M8 connector)
<b>Protection class</b>	III
<b>Reverse polarity protection</b>	Yes

### 9.2 Outputs

<b>Output function</b>	2 x NO, 1 x NO + 1 x NC, 2 x NO + 1 x NC
<b>Voltage drop</b>	3.5 V for sensors with LED 0.5 V for sensors without LED
<b>Rated operational current I<sub>e</sub></b>	0.25 A (resistive load)
<b>Short circuit proof</b>	No
<b>Switching frequency</b>	100 Hz
<b>Max switching load</b>	6W (resistive load)

### 9.3 Actuating characteristics

<b>Operating principle</b>	Magnetic
<b>Actuator</b>	MC88CM <sub>y</sub> coded
<b>Coding level according to EN ISO 14119</b>	Low

### 9.4 Switching distances

<b>Assured switching distance S<sub>ao</sub></b>	MC88CM1: 5 mm*; MC88CM2: 8 mm*; MC88CM3: 18 mm*
<b>Assured switch-off distance S<sub>ar</sub></b>	MC88CM1: 15 mm*; MC88CM2: 18 mm*; MC88CM3: 30 mm*
<b>Repeat accuracy</b>	≤ 10%
<b>Distance between two sensors</b>	Min. 50 mm

### 9.5 Environmental conditions

<b>Application (according to EN 60654-1)</b>	Class C
<b>Operating temperature</b>	-25...80 °C (-13...176 °F)
<b>Max. perm. Relative humidity</b>	Short time: 5...95% Permanent: 5...70%
<b>Protection class (IEC 60529)</b>	IP67
<b>Pollution degree</b>	3

### 9.6 Approvals / tests

<b>EMC</b>	IEC 60947-5-2
<b>Shock resistance (EN 60068-2-27)</b>	30 g (11 ms)
<b>Vibration resistance (EN 60068-2-6)</b>	10 g (10...150 Hz)

## 9.7 Safety classification

### B10D for each channel

700 000 operations (@ 250mA resistive load)  
Mechanical endurance 80 millions operations

## 9.8 Mechanical data

<b>Installation</b>	Non flush mountable
<b>Housing material</b>	Glass-fiber reinforced thermoplastic
<b>Tightening torque (for M8 connector)</b>	Max 1.5 Nm
<b>Weight</b>	85 g
<b>Potential-free</b>	Yes
<b>Type of connection</b>	PVC cable 4x0.25 mm <sup>2</sup> M8 connector Pig tail: PVC cable 0.1 m, Ø 5mm, with M12 connector

## 9.9 Cable version

Model	Output contact	Associated actuator	Usage category
MC88CH2OxA2	2 NO	MC88CMy	max. 4
MC88CH2OxA2L	2 NO	MC88CMy	max. 4
MC88CH1O1CxA2	1NO + 1NC	MC88CMy	max. 4
MC88CH1O1CxA2L	1NO + 1NC	MC88CMy	max. 4
MC88CH2O1CxA2	2NO + 1NC	MC88CMy	max. 4
MC88CH2O1CxA2L	2NO + 1NC	MC88CMy	max. 4

## 9.10 Plug version

Model	Output contact	Associated actuator	Usage category
MC88CH2OxM5	2 NO	MC88CMy	max. 4
MC88CH2OxM5L	2 NO	MC88CMy	max. 4
MC88CH1O1CxM5	1NO + 1NC	MC88CMy	max. 4
MC88CH1O1CxM5L	1NO + 1NC	MC88CMy	max. 4

## 9.11 Pigtail version

Model	Output contact	Associated actuator	Usage category
MC88CH2OxT1	2 NO	MC88CMy	max. 4
MC88CH2OxT1L	2 NO	MC88CMy	max. 4
MC88CH1O1CxT1	1NO + 1NC	MC88CMy	max. 4
MC88CH1O1CxT1L	1NO + 1NC	MC88CMy	max. 4

x:

- L= left exit
- R= right exit

y:

- 1= Sao: 5mm; Sar: 15mm
- 2= Sao: 8mm; Sar: 18mm
- 3= Sao: 18mm; Sar: 30mm

\*assuming a correct alignment between sensor and actuator