

SECTION A-A

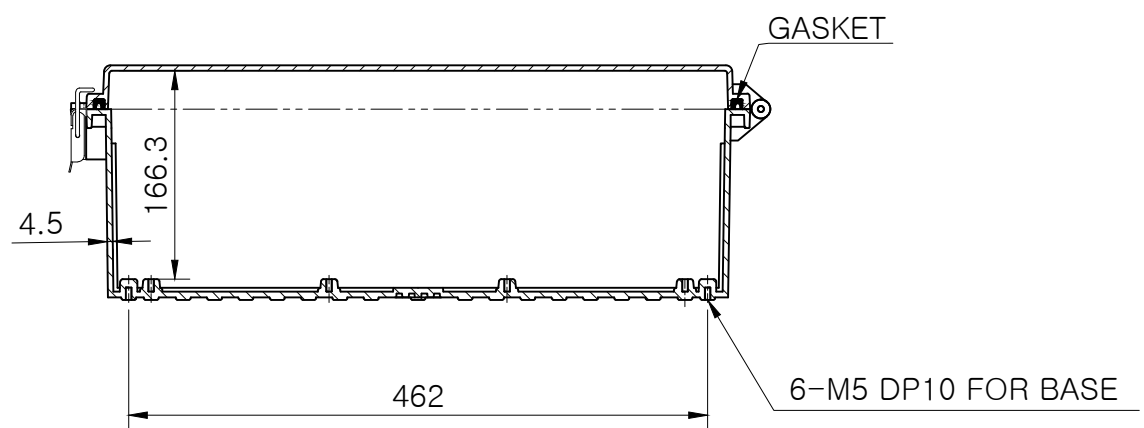
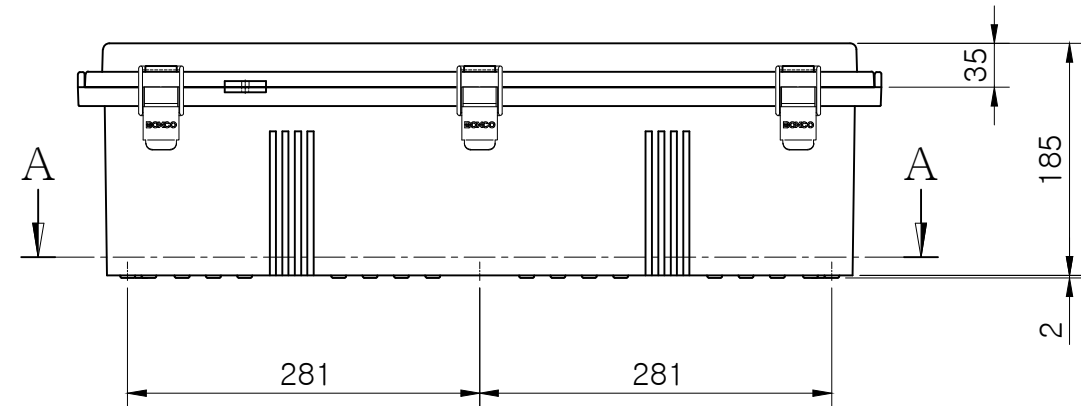

SECTION B-B

Note.

MODEL (모델)	BC-□□P-506018			D R (재도)	JUNG, Y.J.	16.05.09	UNIT (단위)	mm
ASSY (완성 규격)	530 * 630 * 185			C K (검도)	PARK, Y.J.	16.05.09	SCALE (척도)	1:6
DWG NO (도번)	P-506018-03	MATERIAL (재질)		A P (승인)	KIM, D.S.	16.05.10	REV. (개정)	0

