

SECTION A-A

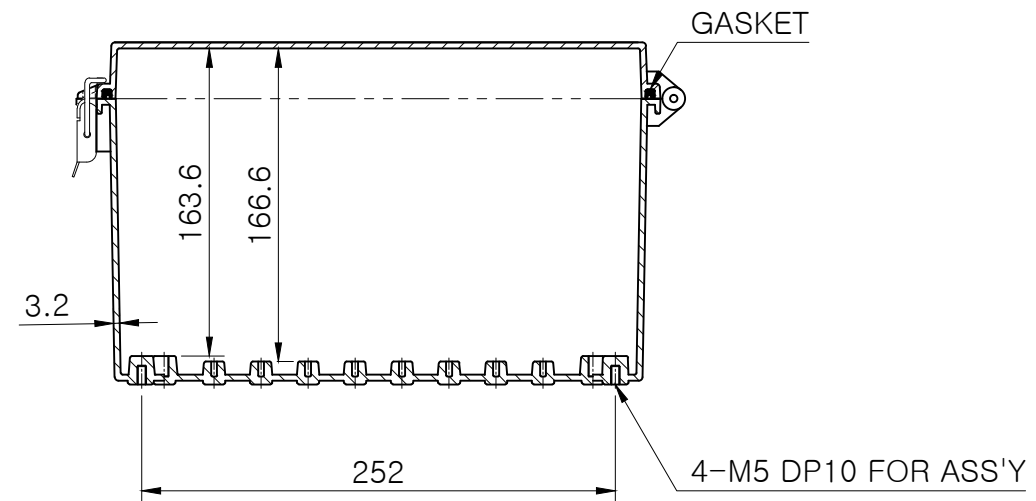
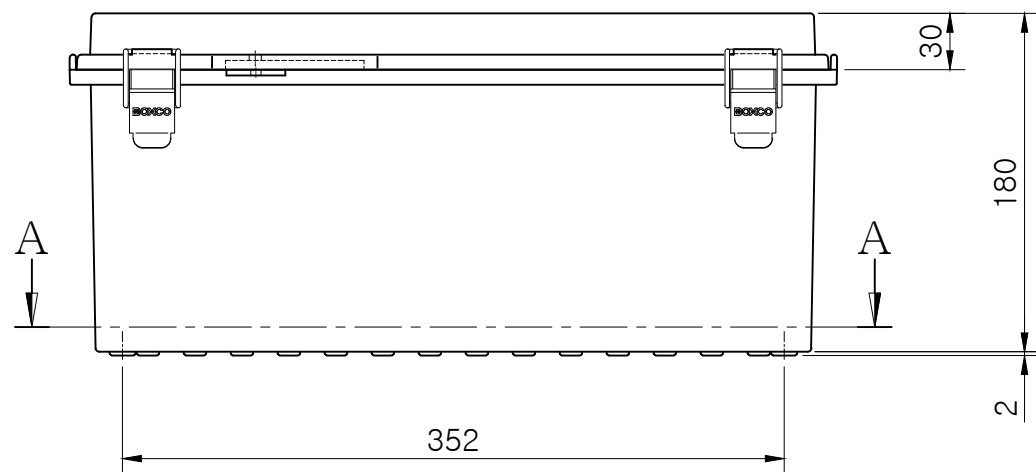

SECTION B-B

Note.

MODEL (모델)	BC-□□P-304018		D R (재도)	JUNG,Y.J.	16.04.13	UNIT (단위)	mm
ASSY (완성 규격)	300 * 400 * 180		C K (검도)	PARK,Y.J.	16.04.13	SCALE (척도)	1:4
DWG NO (도번)	P-304018-03	MATERIAL (재질)	A P (승인)	KIM,D.S.	16.04.14	REV. (개정)	0

BOXCO[®]