

SECTION A-A

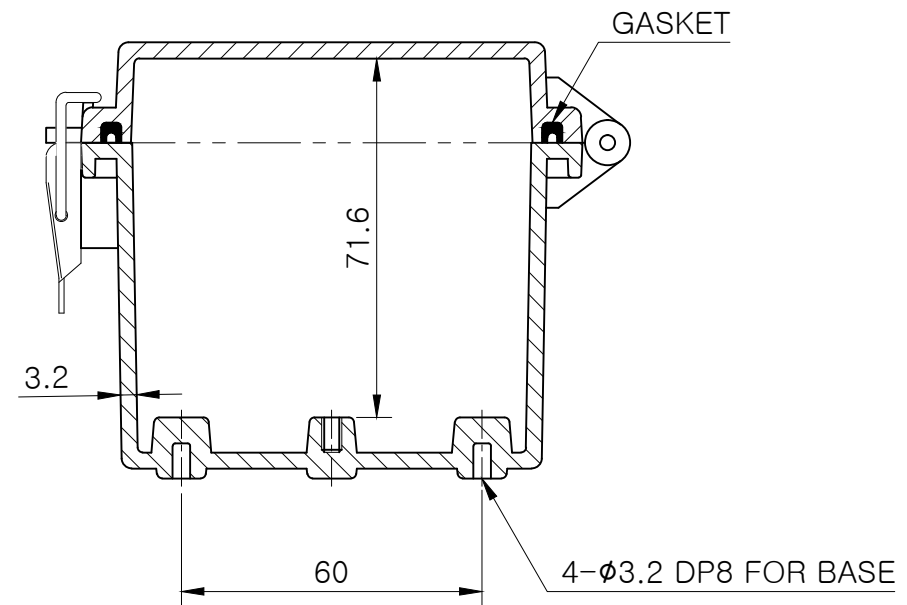
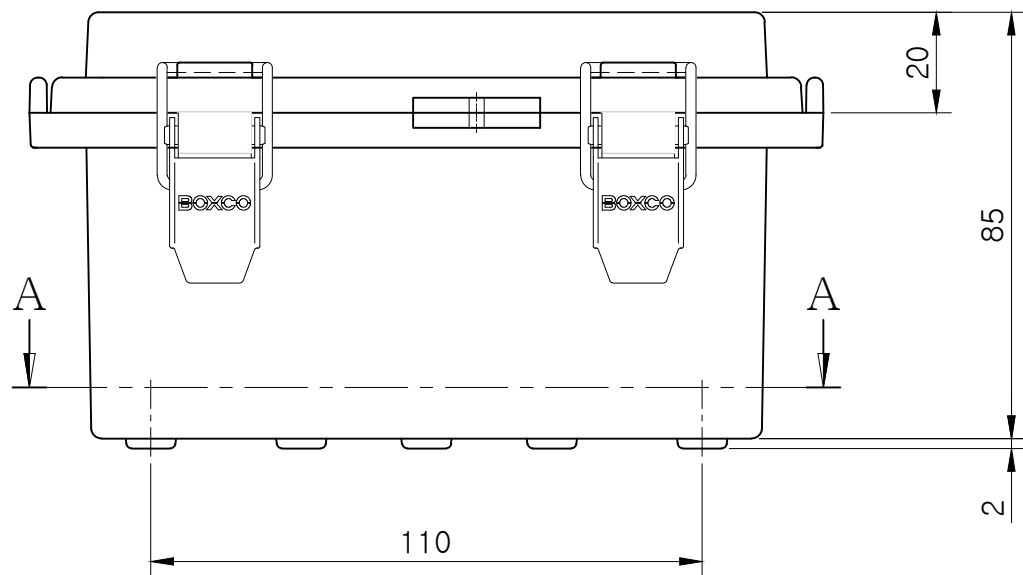

SECTION B-B

Note.

MODEL (모델)	BC-□□P-101508			D R (제 도)	JUNG, Y.J.	16.03.16	UNIT (단 위)	mm
ASSY (완성 규격)	100 * 150 * 85			C K (검 도)	PARK, Y.J.	16.03.16	SCALE (척 도)	1:1.5
DWG NO (도 번)	P-101508-03	MATERIAL (재 질)		A P (승 인)	KIM, D.S.	16.03.19	REV. (개 정)	0

BOXCO[®]