

# Altech Corp.® IN Modular Limit Switches

by  BERNSTEIN

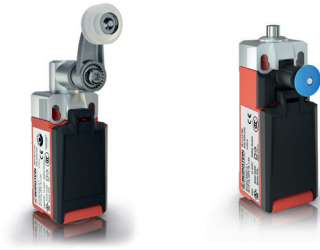

## Advantages

- Metal mounting and actuators components offer the benefits of a metal switch at plastic switch prices
- Actuators can be changed or adjusted without tools
- Modular switch bodies, contact blocks and actuators allow better utilization of stock
- Protection Class IP67
- Highly reliable at low current switching (1 mA)
- Mechanical service life up to 30 million switching cycles

**Easy to assemble components all sold separately.**

## Housings

(Without Actuator or Contact Block)



608.3000.248  
M20 SWITCH BODY



608.3000.252  
LATCHING SWITCH BODY  
WITH RESET BUTTON

## Contact Blocks

(snaps into housing without tools)

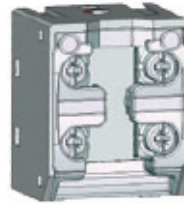

1NC/1NO Slow Action	600.5101.156 C14-EB U1Z
------------------------	----------------------------

1NC/1NO Snap Action	600.5151.157 C14-EB SU1Z
------------------------	-----------------------------

2NC Slow Action	600.5801.159 C14-EB A2
--------------------	---------------------------

## Actuators

(Mounts into switch body without Tools)

### PLUNGER



391.8052.341  
SM Actuator

### ROLLER PLUNGER



391.8172.342  
RK Actuator

### ROLLER LEVER



391.8202.343  
HK Actuator

### SIDE MOUNT ROLLER LEVER



391.8352.345  
AHK Actuator

### SWIVEL POINT LEVER



391.8202.344  
DGHK Actuator

### SWIVEL KNEE LEVER



391.8202.348  
DGKK Actuator

### SIDE MOUNTED ROLLER

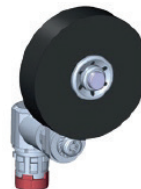

391.8352.359  
AGSGU RO50 Actuator

### ADJUSTABLE HEIGHT ROLLER

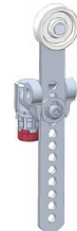

391.8362.358  
AVK Actuator

## Dimensions

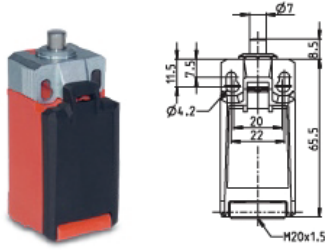

IN65...SM

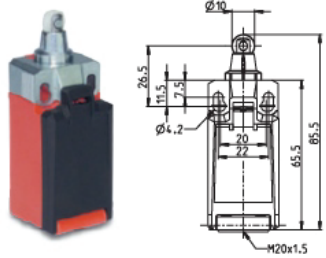

IN65...KR

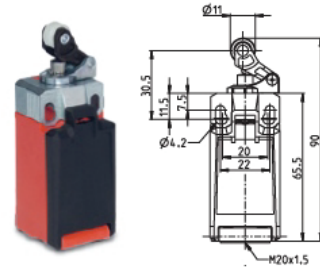

IN65...HK

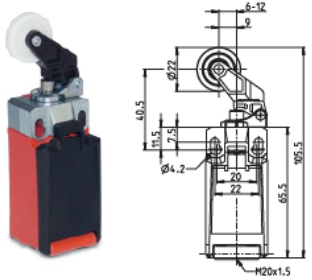

IN65...DGHK

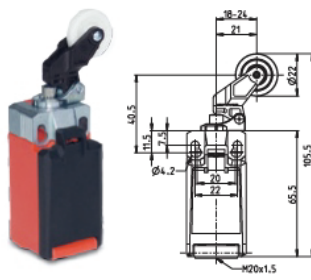

IN65...DGKK

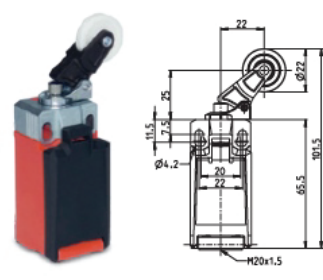

IN65...KNK

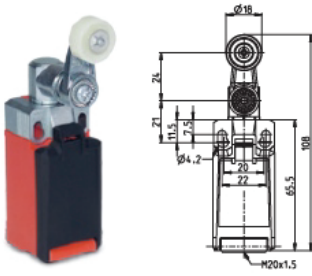

IN65...AHK

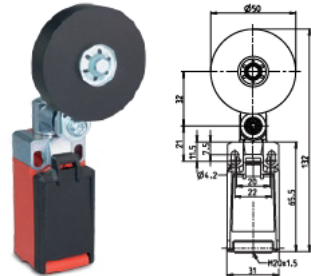

IN65...AHSU RO50

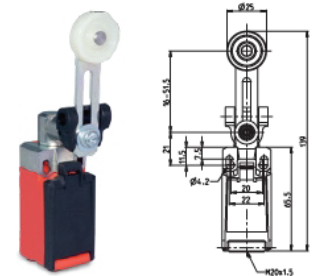

IN65...AVK

## Actuator Installation & Rotation

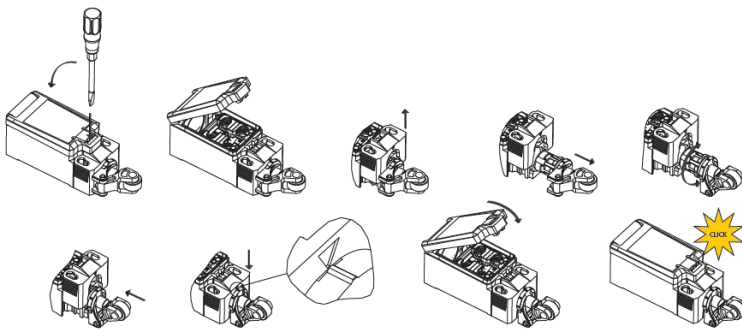

## Technical Information

Rated operating voltage	240VAC / 24VDC
Conv. thermal current	5 A
Minimum current	1 mA
Rated AC frequency	50/60 Hz
Utilization category	AC15, Ue/Ie 240V/1.5A DC13, Ue/Ie 24V/1.5A
Conductor sizes	22AWG - 16AWG
Cover & Enclosure	Thermoplastic (UL94-V0)
Operating temperature	-30°C...+75°C
Protection rating	IP66 / IP67 acc. EN60529
Contact material	Silver
B10d N.C.	30x10 <sup>6</sup> cycles Tbd (check acc. to DIN EN 6-947-5-1)
B10d N.O	1x10 <sup>6</sup> cycles (Tbd contact with reduced power use for resistive load).

# Learn More @

[www.altechcorp.com/bernstein/LimitSwitches.html](http://www.altechcorp.com/bernstein/LimitSwitches.html)

Altech Corporation  
35 Royal Road  
Flemington, NJ 08822-6000  
P 908.806.9400 • F 908.806.9490  
www.altechcorp.com

Altech Corp.® 580-2000  
Printed November 2015