

**Ultrasonic proximity sensors**

**UNAM 12N1912/S14**

**dimension drawing**

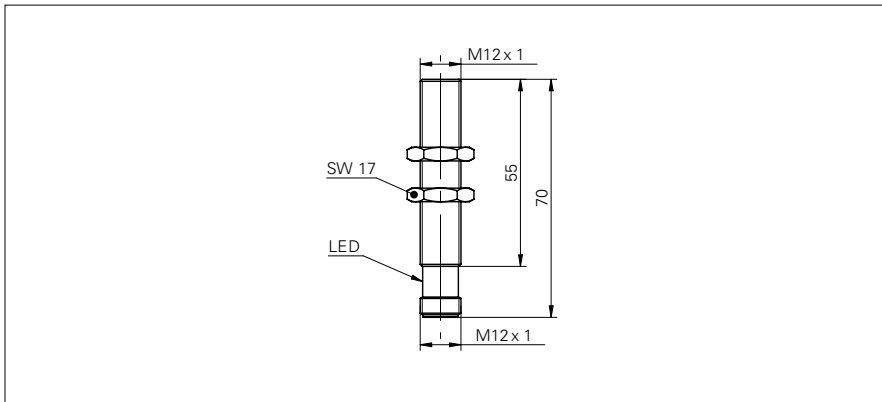

**general data**

scanning range Sd	40 ... 400 mm
scanning range far limit Sde	60 ... 400 mm
hysteresis typ.	4 % Sde
repeat accuracy	< 0,5 mm
temperature drift	< 0,18 % Sde/K
response time ton	< 25 ms
release time toff	< 25 ms
sonic frequency	290 kHz
adjustment	external Teach-in
alignment aid	target indication flashing
output indicator	LED green

**electrical data**

voltage supply range +Vs	12 ... 30 VDC
current consumption max. (no load)	35 mA
output circuit	NPN make function (NO)
output current	< 200 mA
voltage drop Vd	< 2 VDC
residual ripple	< 10 % Vs
short circuit protection	yes
reverse polarity protection	yes

**mechanical data**

type	cylindrical threaded
housing material	brass nickel plated
width / diameter	12 mm
height / length	70 mm
connection types	connector M12

**ambient conditions**

operating temperature	-10 ... +60 °C
protection class	IP 67

**photo**



**connection diagram**

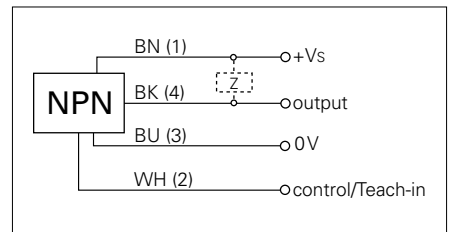

- external Teach-in
- miniature housing

# Ultrasonic proximity sensors

# UNAM 12N1912/S14

typical sonic cone profile

