

Operating instructions.

PosCon OXH7 – Clever height measurement.

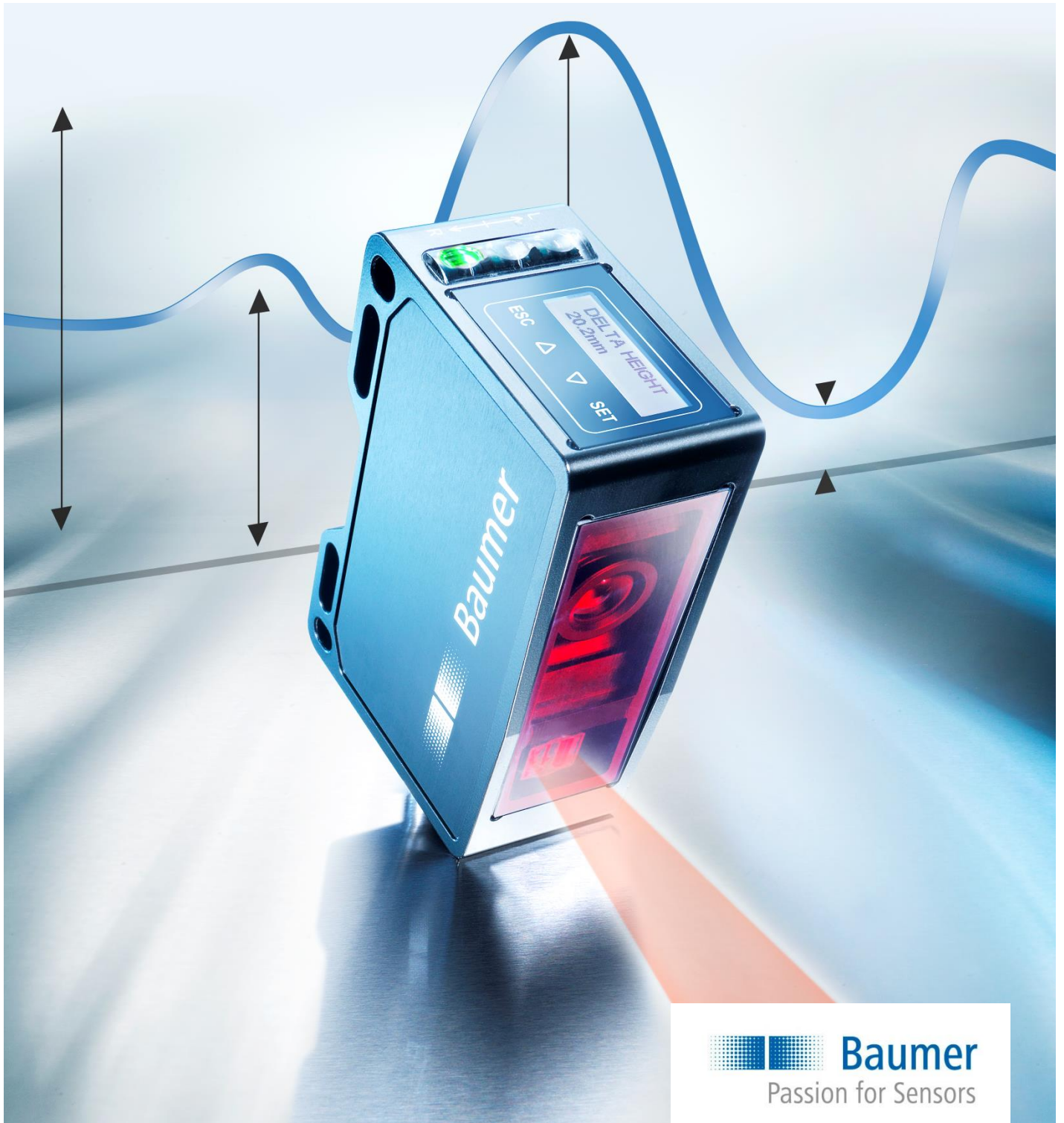

Contents

1	General information.....	4
1.1	Concerning the contents of this document	4
1.2	Intended use	4
1.3	Safety.....	4
2	Commissioning.....	5
3	Connection	9
3.1	Connection cable	9
3.2	Pin assignment and connection diagram.....	10
4	Installation	11
4.1	Mounting	11
4.2	Sensor reference levels	11
4.3	The reference surface.....	12
4.4	Measuring field definition	13
4.5	Mounting:	15
4.6	Installation accessories.....	17
5	Configuration	19
5.1	Overview of control elements	19
5.2	Function tree	22
5.3	LIVE MONITOR	23
5.4	MEAS TYPE	26
5.5	FLEX MOUNT (Function HEIGHT).....	27
5.6	OBJECT.....	32
5.7	PRECISION	32
5.8	FIELD OF VIEW	35
5.9	ANALOG OUT	37
5.10	DIGITAL OUT.....	39
5.11	SYSTEM	41
5.12	SETTING	43
6	Function and definition	44
6.1	Sensors data sheet.....	44
6.2	Functional principle.....	48
6.3	Measuring repetition time and response time.....	50
6.4	Hysteresis	51
6.5	Object to be measured	53
6.6	Interfaces and outputs	54
6.7	Touch panel.....	62
6.8	Memory.....	62
6.9	Standard deviation.....	63
7	Safety instructions and maintenance.....	64
7.1	General safety instructions	64
7.2	Part Identification	64
7.3	Influence of ambient light.....	66
7.4	Front (optics).....	66
7.5	Cleaning the sensors	66
7.6	Disposal	66

8	Error correction and tips	67
8.1	Examples of sensor setup	67
8.2	Error correction	68
9	Revision history	69

1 General information

1.1 Concerning the contents of this document

This manual contains information about the installation and initial setup of Baumer PosCon OXH7 sensors. It is a supplement to the mounting instructions supplied with each sensor.



Read these operating instructions carefully and follow the safety instructions!

1.2 Intended use

The Baumer PosCon OXH7 sensor measures heights of objects. It was especially developed for easy handling, flexible use, and precise measurement.

1.3 Safety



NOTE

Provides helpful operation instructions or other general recommendations.



ATTENTION!

Indicates a possibly hazardous situation. If it is not avoided, minor or slight injuries can occur or the device can be damaged.

2 Commissioning

After the sensor is connected and installed, configure it via the display. The sensor is then ready for operation and outputs the measuring value in mm to the screen. Optionally, the measuring field can be limited or the switching output can be configured.

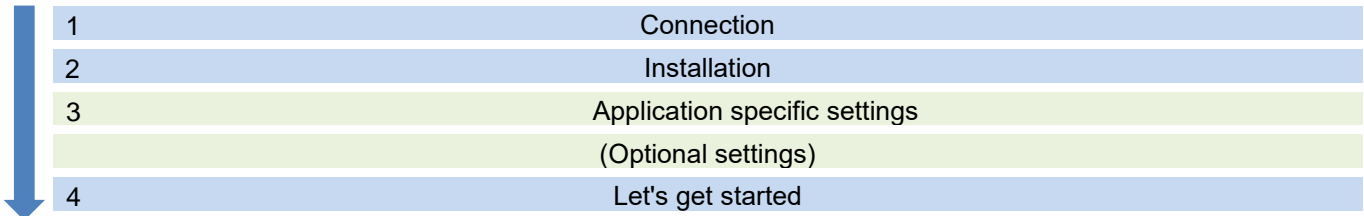

1 Connection

Connect the sensor according to the connection diagram. A shielded connection cable (8-pole M12) must be used.

When everything is correctly connected, the sensor starts up.

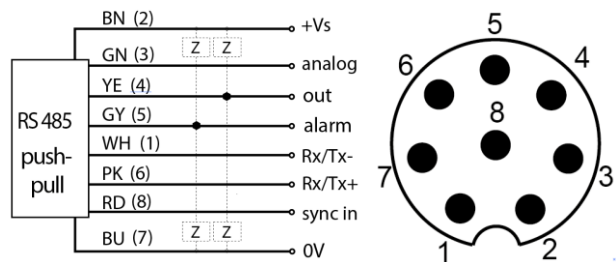

Key functions

ESC	= Back
ESC 2 sec.	= Run mode
UP	= Up/increase value
DOWN	= Down/decrease value
SET	= OK
SET 2 sec.	= Save value

Slide over all 4 keys:

---->	= Enables the panel if locked
<----	= Jump to run mode



Setting the language

The language is selected and confirmed by pressing SET for 2 seconds.

English
Deutsch
Italiano
Français

2 Installation

Function HEIGHT

At the function HEIGHT, the reference surface will be teachted-in with FLEX MOUNT.

The sensor can be mounted angled with up to $\pm 30^\circ$ to the reference surface.

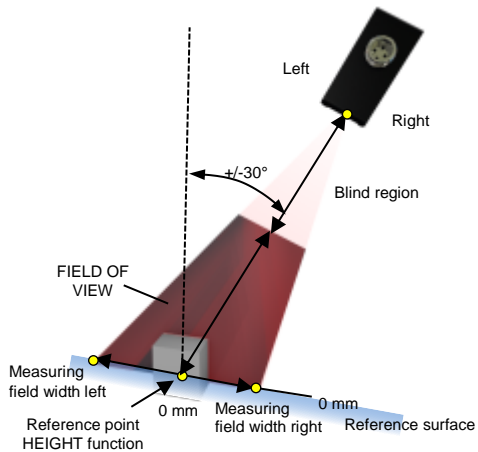

The sensor may be mounted at an angle inclined maximally 30° to the left or to the right of the reference surface (background). Reference surface (background) and object must lie within the measuring field.

3 Application specific settings

3b HEIGHT *Height of an object*

For a height measurement, the required MEAS TYPE (average value, maximum, minimum or delta). The reference surface (0) is the maximum measuring range of the sensor, or if present, the FLEX MOUNT teached reference surface.

- Avg HEIGHT** = Distance of the average value of the object from the reference surface
- Max HEIGHT** = Distance of the furthest measuring point from the reference surface
- Min HEIGHT** = distance of the closest measuring point from the reference surface
- Delta HEIGHT¹** = Difference between the closest and furthest measuring point

LIVE MONITOR	▽		
MEAS TYPE	△ ▽	Avg HEIGHT Max HEIGHT Min HEIGHT Delta HEIGHT	
FLEX MOUNT	△ ▽	No Yes	TEACH REF CORRECTION
OBJECT	△ ▽	Bright Dark	
PRECISION	△ ▽	Standard High Very High	
FIELD OF VIEW	△ ▽	LIMIT LEFT	Value in mm
		LIMIT RIGHT	Value in mm
		Set max values	
ANALOG OUT	△ ▽	SCALE OUT	Offset Value in mm Height Value in mm Set max values
		ANALOG OUT	Current / Voltage
		CHARACTERISTIC	Pos. slope / Neg. slope
	DIGITAL OUT	△ ▽	DIGITAL OUT
		SWITCH POINT	Value in mm
		WINDOW P1	Value in mm
		WINDOW P2	Value in mm
		OUTPUT LEVEL	Active high / Active low

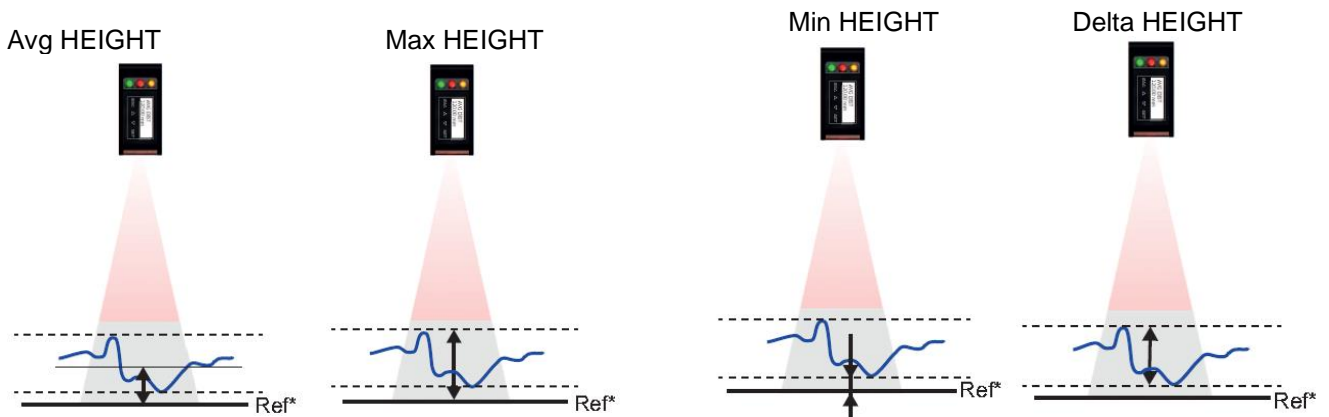

¹ In the factory settings Delta HEIGHT is predefined

Optional settings

FLEX MOUNT

If the sensor is mounted at an angle or the reference surface is not at the End of the measuring range Sde, FLEX MOUNT must be activated and the reference surface taught in.

If FLEX MOUNT is activated, the following settings are reset: SCALE OUT, FIELD OF VIEW and DIGITAL OUT.

OBJECT

Selection of bright or dark objects to optimize the measurement results.

PRECISION

To achieve better precision and resolution, it is possible to alternate between Standard, High and Very High by filtering the output values.

SCALE OUT

Start of measuring range Sdc and end of measuring range Sde can be changed with SCALE OUT. 0V or 4mA then apply for the start of measuring range Sdc. 10V or 20 mA apply for the point at the end of measuring range Sde.

FIELD OF VIEW

The width of the measuring field can be changed with FIELD OF VIEW. Separate configuration of the single points of the field: LIMIT LEFT, LIMIT RIGHT.

This function is required when there are objects in the measuring field that should not be detected.

ANALOG OUT

Start of measuring range Sdc (Offset) and end of measuring range Sde (Height) can be changed with SCALE OUT. 0V or 4mA then apply for the start of measuring range Sdc. 10V or 20 mA apply for the point at the end of measuring range Sde. Voltage and current output is selected under ANALOG OUT. In addition, the output curve can be inverted under OUTP. SLOPE.

DIGITAL OUT

The sensor is equipped with a switching output that can be configured as a threshold or as a window via the DIGITAL OUTPUT function.

Threshold: As soon as the measuring value is greater than the entered threshold, the switching output will be changed.

Window: As soon as the measuring value is outside the entered window, the switching output will be changed.

4 Let's get started

The sensor continuously outputs the measuring value in mm to the display and transmits it via the analog output to the control. Alternatively, the measuring value can also be retrieved from the RS485 interface.

3 Connection

ATTENTION!

Incorrect supply voltage will destroy the device!

ATTENTION!

Connection, installation and commissioning may only be performed by qualified personnel.

ATTENTION!

The IP protection class is valid only if all connections are connected as described in the technical documentation.

ATTENTION!

Laser class 1 laser beam according to EN 60825-1:2007. This product can be operated safely without any additional safety precautions. Nevertheless direct contact between the eye and beam should be avoided.

3.1 Connection cable

An 8-pole, shielded connection cable (connector) is required.

Baumer connection cables with the following order codes are recommended:

- 10127844 ESG 34FH0200G (length 2 m, straight plug)
- 11053961 ESW 33FH0200G (length 2 m, angled plug)
- 10129333 ESG 34FH1000G (Länge 10 m, straight plug)
- 10170054 ESW 33FH1000G (Länge 10 m, angled plug)

Other cable lengths are available.

When using the analogue output, the cable length has an influence on the signal noise. The longer the cable, the greater the signal noise.

Analog output I_OUT

Noise: 5.92 μ A (1 Sigma) (10 m cable and 680 ohm)
 3.59 μ A (1 sigma) (2m cable and 680 ohm)

Analog output U_OUT

Noise: 4.80 mV (1 Sigma) (10m cable and 100 kOhm)
 3:03 mV (1 Sigma) (2m cable and 100 kOhm)

For high-precision applications, the use of the RS485 interface is recommended.

3.2 Pin assignment and connection diagram

Pin	Color	Function	Description
Pin 1	WH = white	Rx/Tx-	RS 485 receive/transmit- (B)
Pin 2	BN = brown	+ Vs	Voltage supply (+15...+28 VDC)
Pin 3	GN = green	analog	Analog output (4...20 mA or 0...10V)
Pin 4	YE = yellow	out	Switching output, push-pull
Pin 5	GY = gray	alarm	Alarm output, push-pull
Pin 6	PK = pink	Rx/Tx+	RS485 receive/transmit+ (A)
Pin 7	BU = blue	0V	Ground GND
Pin 8	RD = red	sync in	Input synchronization

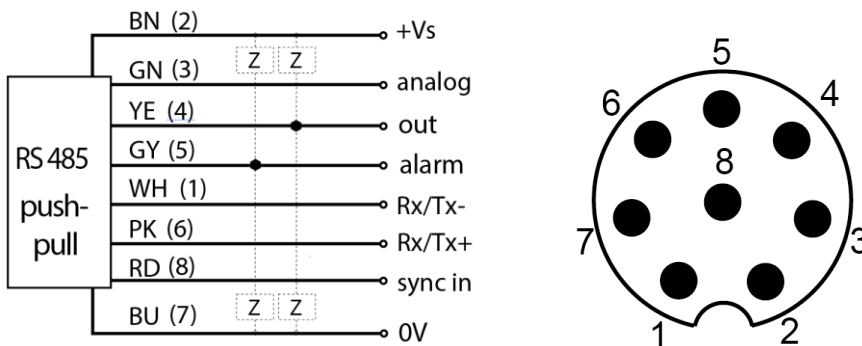

NOTE

It is recommended to connect unused inputs to GND (0V).

4 Installation



ATTENTION!

Connection, installation and commissioning may only be performed by qualified personnel. Protect optical surfaces from moisture and dirt.

4.1 Mounting

The sensor has four mounting holes for flexible alignment and mounting. The use of 2 M4x35 screws is recommended for mounting. The tightening torque is max. 1.2 Nm.

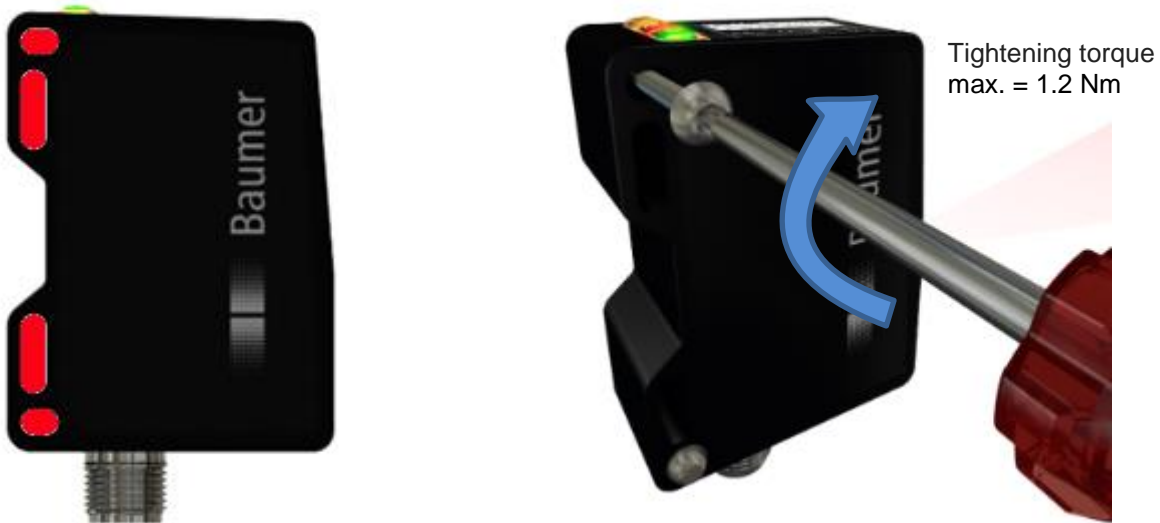

4.2 Sensor reference levels

To ensure easy alignment of the sensor during installation, the surfaces defined here are available: The laser beam of the sensor runs parallel (//) to level R3 and is at a right angle to levels R1 and R2. Levels R1, R2, and R3 serve as references for sensor alignment during installation. "Left" and "Right" designations are also important.

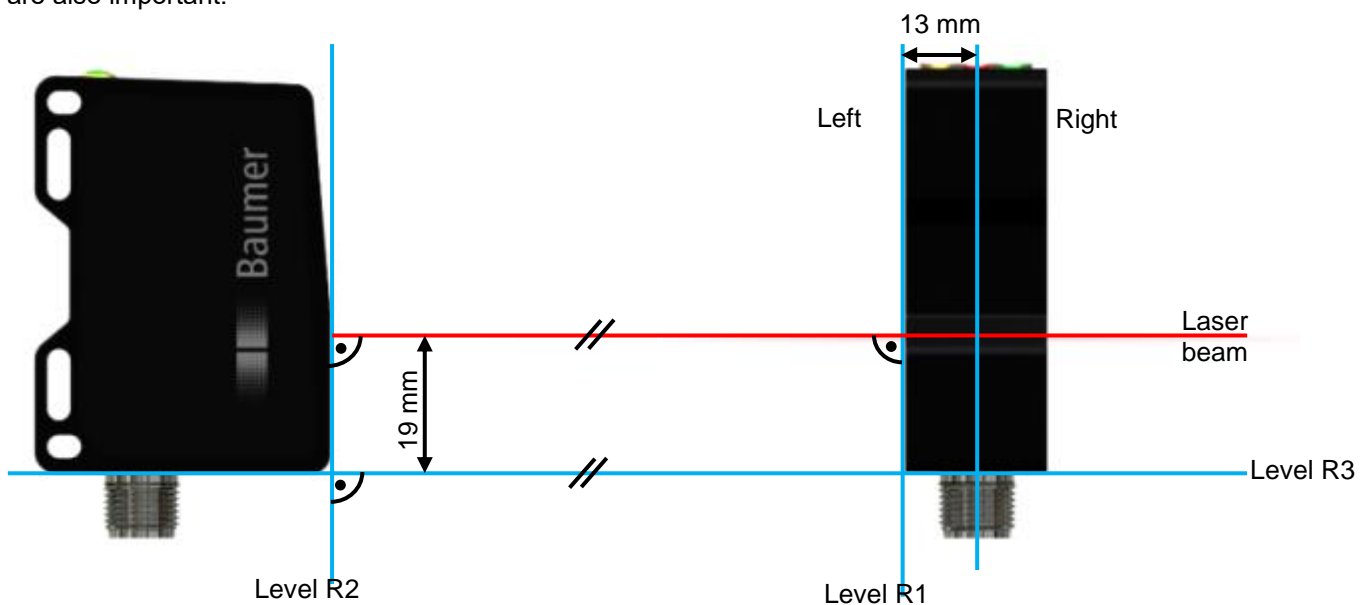

4.3 The reference surface

If the height of the object is to be measured from a specific surface or the sensor is mounted at an angle up to $\pm 30^\circ$, then the reference surface must be taught in with the FLEX MOUNT function.

The following points must be satisfied for teaching in the reference surface:

- The reference surface must lie within the measuring range of the sensor.
- The sensor may be inclined at a maximum angle of $\pm 30^\circ$ to the reference surface.
- The "Maximum reference surface unevenness"¹ must not exceed the maximum value.
- The length of the reference surface must not be less than the "minimum reference surface length"¹ value.

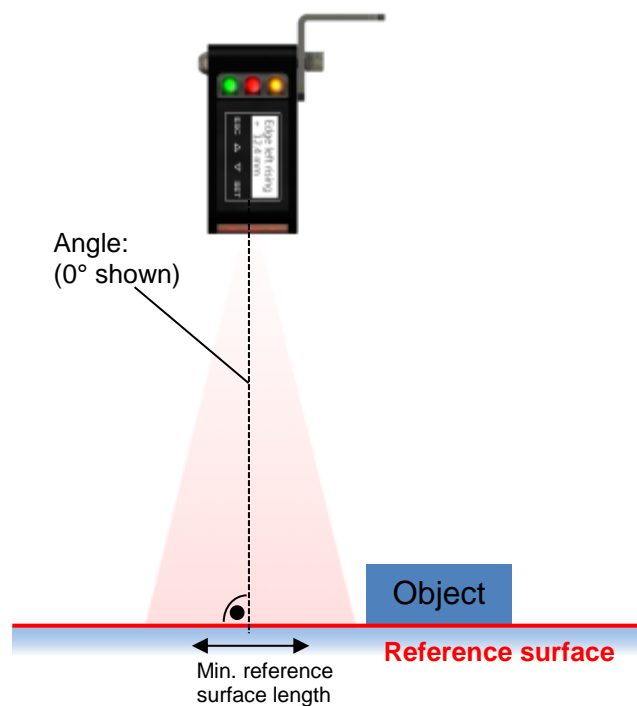

NOTE



The reference surface...

- should be as flat as possible
- should cover the entire measuring range (width) if possible
- can be taught-in with the FLEX MOUNT function

¹ According to data sheet chapter 6.1

4.4 Measuring field definition

The maximum measuring field and additional important measuring field definitions are described in the following diagram. The important terms "left" and "right" are to be regarded respectively from the viewpoint of the connector side of the sensor.

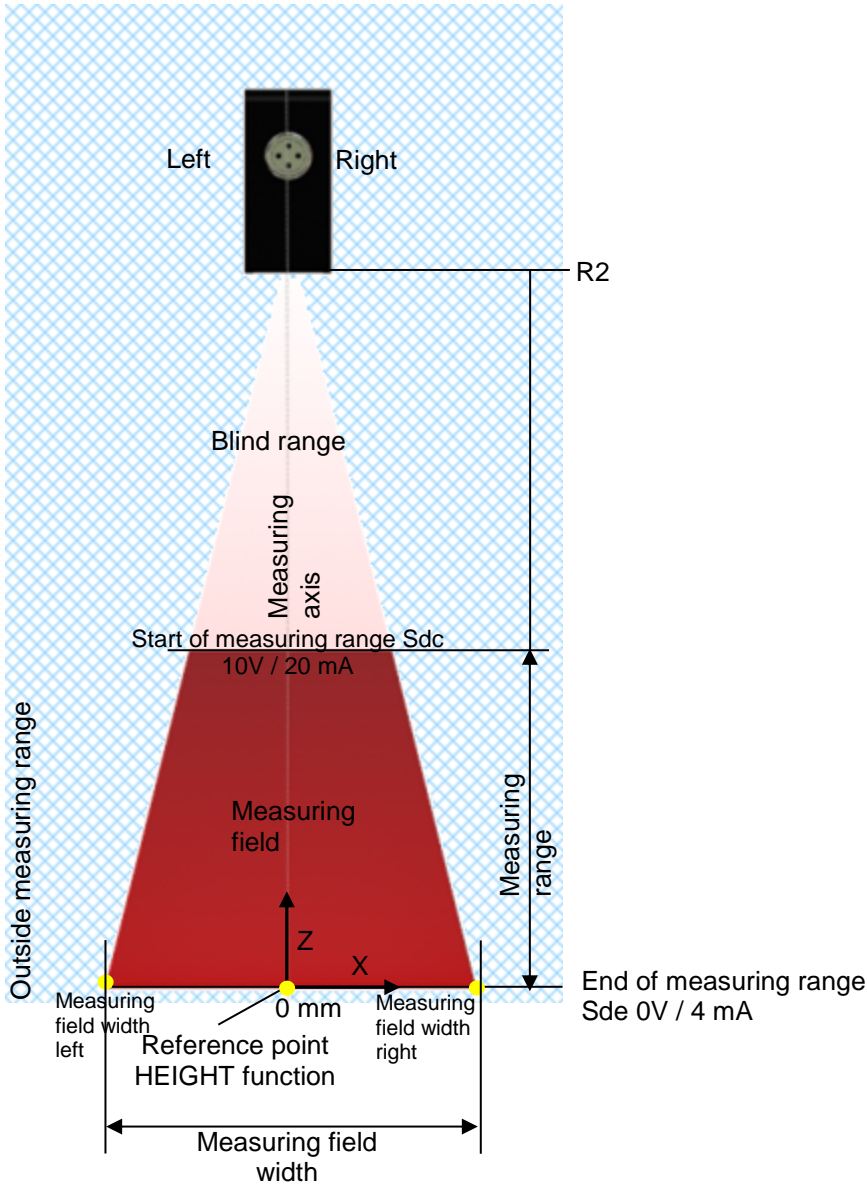

The sensor measures the height of objects within the measuring field. With the HEIGHT function, it is the end of measuring range Sde or optionally the teach-in reference surface (if FLEX MOUNT is active).

NOTE

 For further explanations, see section "Function and definition" -> "Interfaces and output" -> "Interfaces and output-> "Analog signal output".

4.4.1 Blind region

The region from sensor level R2 up to the start of measuring range Sdc is called the blind region, i.e. the sensor cannot detect any objects there.

Objects in this area can cause incorrect measuring values.

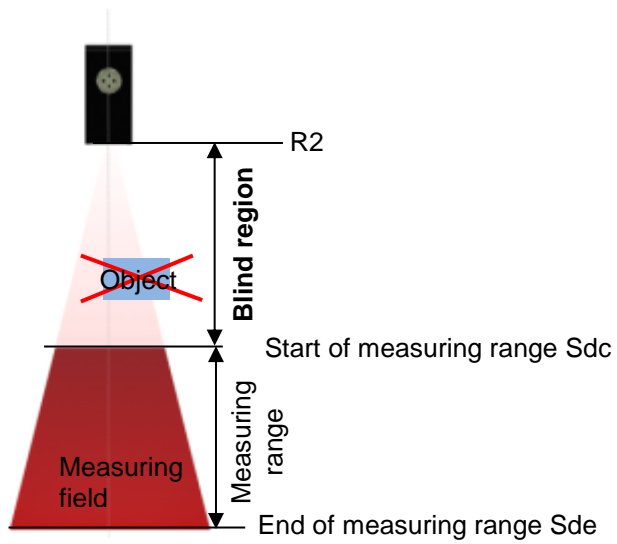

4.5 Mounting:

The sensor can be installed at an inclination of up to $\pm 30^\circ$ to the reference surface. This is particularly useful when space conditions do not allow any other installation option. See the FLEX MOUNT section. After activation of FLEX MOUNT, the sensor axis is no longer relevant. The measurement coordinate system is now represented by the M and K axes. The height is now measured in M-direction.

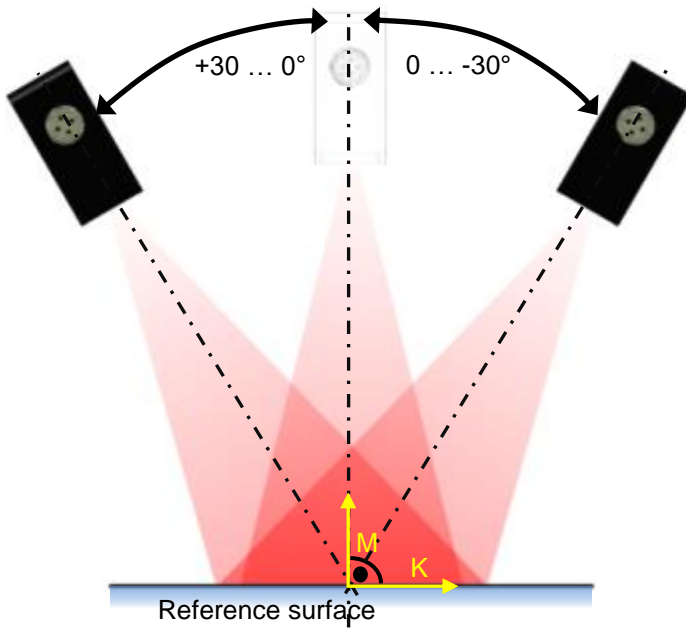

4.5.1 Reference point with inclined installation

In the case of angled installation, the zero point (0 mm) of the K axis shifts out of the center of the measuring field or the red visible laser line. Due to inclination of the sensor, the two measuring field sections, "measuring field width left" and "measuring field width right", are no longer equal in size.

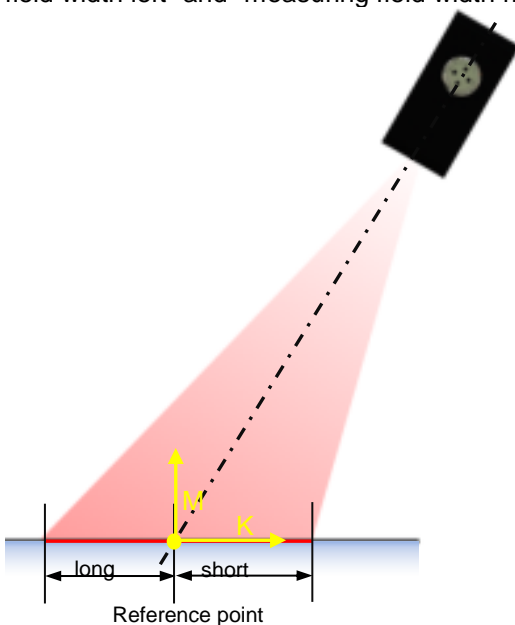

NOTE

 This fact is relevant where the position of the reference point plays a role, e.g. with the FIELD OF VIEW function. LIMIT LEFT and LIMIT RIGHT are measured from this point.

4.5.2 Practical zero point search

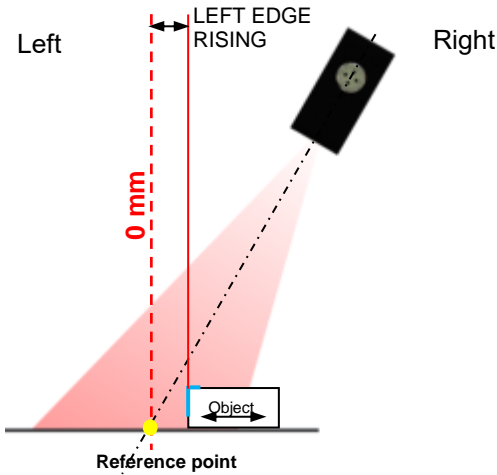

The LIVE MONITOR mode can be used to find the reference point (0 mm). This function displays the LEFT EDGE RISING (the first rising edge from the left side) of objects. Now an object is slowly pushed toward the presumed zero point. The zero point is reached when the value 0 mm is shown on the sensor display.



Position of object LEFT EDGE RISING

NOTE

 If the sensor is mounted inclined, FLEX MOUNT has to be activated.

4.6 Installation accessories

To ensure optimal mounting, various mounting brackets are available as an accessory. These brackets fit the mounting holes of the sensor exactly. The sensor can be shifted and adjusted inside the mounting hole.

4.6.1 Mounting kit for standard installation Order no. 11120705

With the mounting bracket for standard installation, the sensor can be mounted quickly and easily at a 90° angle to the reference surface.

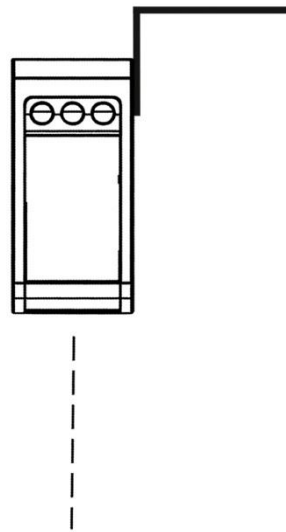

Mounting kit 11120705

Contents of this set:

- 90° mounting bracket
- Threaded plate
- 2x spherical head screw M4x35
- 1x Torx tool T20

4.6.2 Mounting kit for $\pm 30^\circ$ angled installation with horizontal mounting Order no. 11126836

If it is not possible to position the sensor at a right angle to the reference surface, the sensor can be mounted at an inclination angle of $\pm 30^\circ$ with this mounting kit.

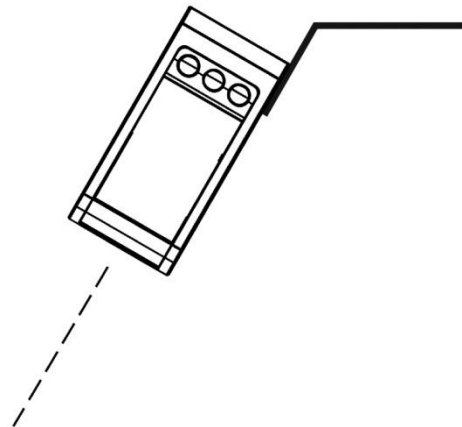

Mounting kit 11126836

Contents of this set:

- 30° mounting bracket, horizontal
- Threaded plate
- 2x spherical head screw M4x35
- 1x Torx tool T20

4.6.3 Mounting kit for $\pm 30^\circ$ angled installation with horizontal mounting Order no. 11126837

If it is not possible to position the sensor at a right angle to the reference surface, the sensor can be mounted at an inclination angle of $\pm 30^\circ$ with this mounting kit.

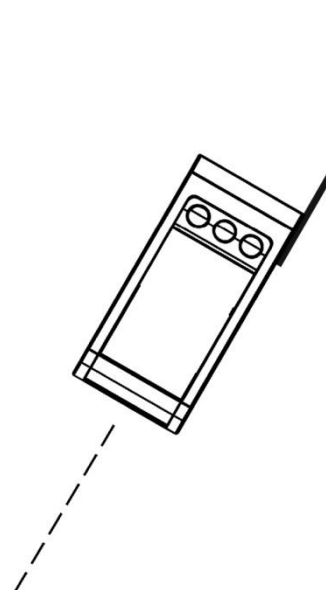

Mounting kit 11126837

Contents of this set:



- 30° mounting bracket, vertical
- Threaded plate
- 2x spherical head screw M4x35
- 1x Torx tool T20

5 Configuration

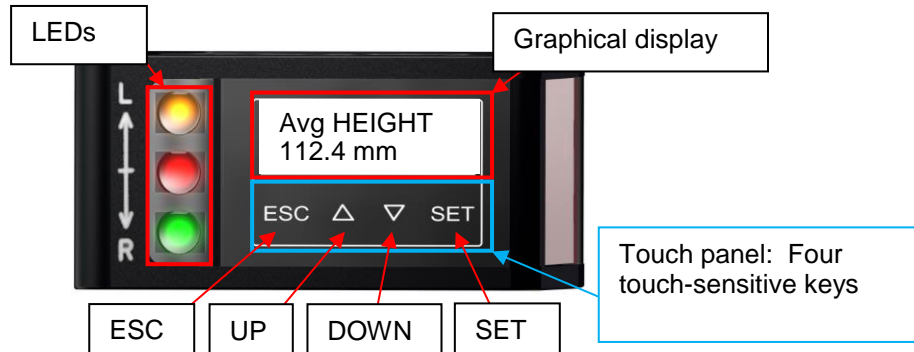
5.1 Overview of control elements



5.1.1 Display modes

112.42 mm		Run mode The sensor is in run mode, the measuring value is displayed in large characters.
AVG HEIGHT 112.42 mm		Main menu In the main menu the active mode is displayed at the top, and the measuring value is displayed at the bottom.
MEAS TYPE AVG HEIGHT		Scroll bar The square on the right side indicates the position within the current menu. The next menu item can be accessed using the arrow keys.
MEAS TYPE AVG HEIGHT		Change value If the function/mode at the top is displayed on a black background, the value of the bottom line can be adjusted using the UP/DOWN keys and saved with SET.
OK		Process successful The display background lights up green: Value successfully saved
FAILURE		Error The display background lights up red: Error during the save process or wrong value entered.
		Setting mode When the sensor is in setting mode the display background lights up blue.
♀ 112.42 mm		Keys locked If this symbol is on the left side of the screen, the touch panel is locked for operation.
∠ AVG HEIGHT 112.42 mm		FLEX MOUNT active The angle symbol appears on the left side of the screen as soon as FLEX Mount is active.

5.1.2 Functions of the individual keys

Key	Pressed briefly	Pressed >2 s.
ESC	Back	Jump to Run mode
UP	Up/increase value	
DOWN	Down/decrease value	
SET	OK	Save new value*

*Only in the setting menu when the top line is displayed on a black background (change value)

5.1.3 Locking the touch panel

The keys on the control panel are locked when they are not pressed for 5 minutes. A key symbol appears, and the measuring value is displayed in large lettering.

When it is pressed, the following text appears:

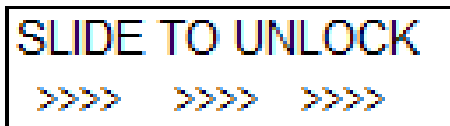

To re-enable the touch panel, it is required to quickly slide a finger over all four keys from left to right (slide over ESC, UP, DOWN, and SET).



When controlled via RS-485:

When the sensor is controlled via RS-485, it cannot be operated via the display at the same time; the keys are deactivated. When the keys are pressed, the following text appears on the display:

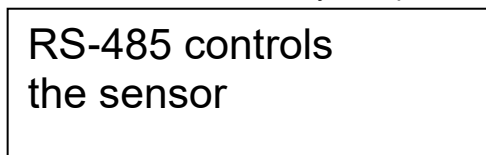

Locking via RS-485 command:

The sensor keys can be permanently locked with a RS-485 command. This locking remains activated even if the sensor is no longer controlled via RS-485. The keys must be unlocked with a RS-485 command. When the locked keys are touched, the following text appears on the display:

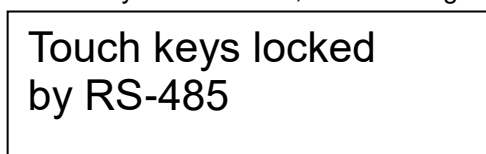

5.1.4 Further key functions

Action	Reaction
Slide over all keys from left to right	Unlock locked touch panel Only if touch panel is locked
Slide over all keys from right to left	Jump directly to run mode Can be used from any menu

5.1.5 LEDs on the sensor

LED	Lights up	Flashes
Yellow	Out1 activated Switching output1 active	-
Red	Out2 activated No measuring object inside the measuring field. Alarm output active.	Insufficient excess gain Object close to signal gain (Not enough light). Performing setting OBJECT (Bright or Dark).
Green	Supply voltage Sensor ready for operation.	Short circuit Check connection on digital output 1 or 2.



5.2 Function tree

The menu that can be accessed via the touch panel is shown below.

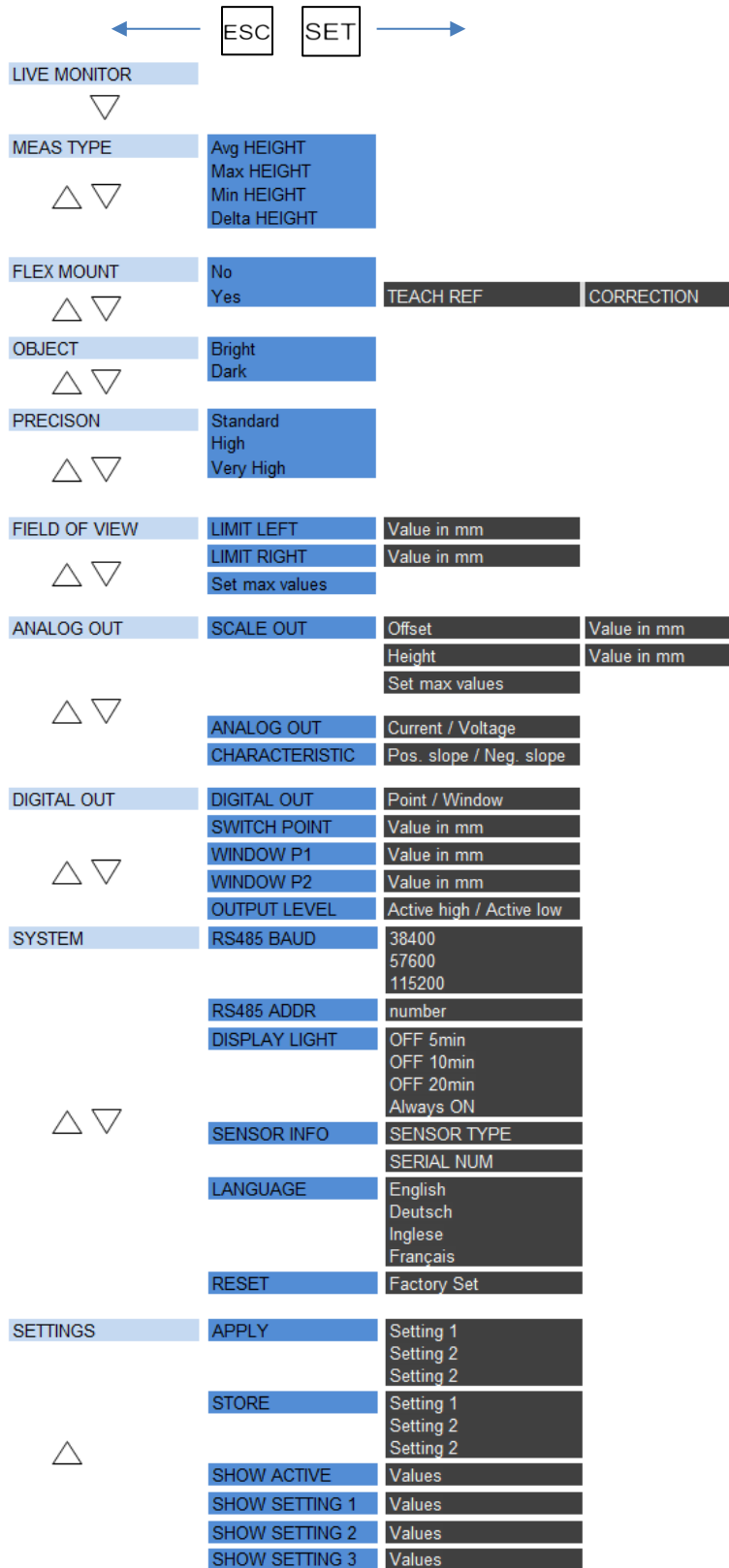

5.3 LIVE MONITOR

The installation conditions can be checked using LIVE MONITOR. The sensor outputs the angle and edge position to the object with the smallest distance to the sensor.

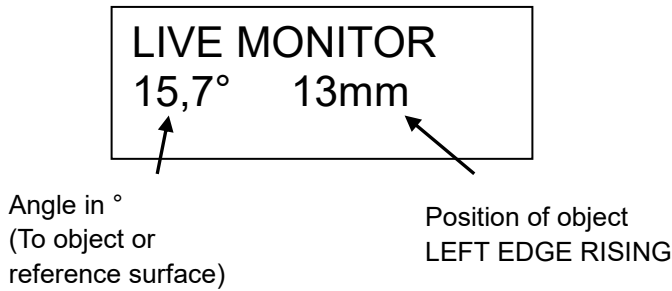

**LIVE MONITOR to reference surface
(FLEX MOUNT deactivated)**

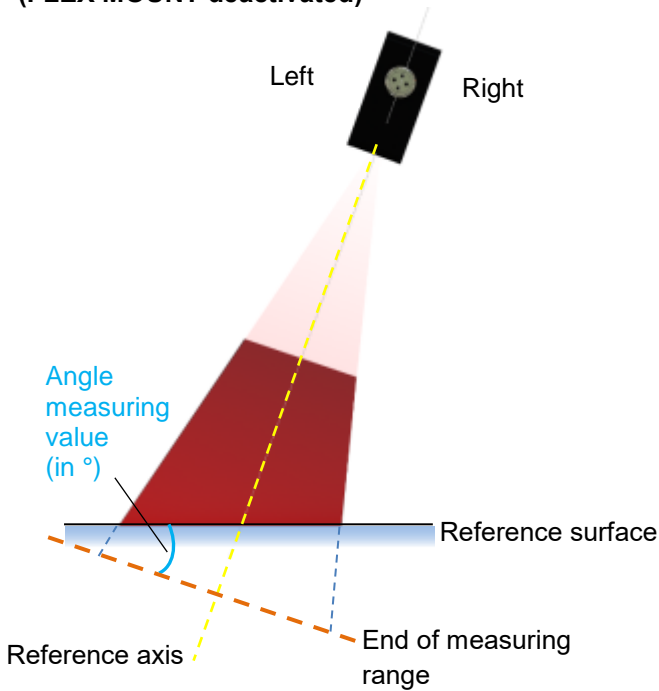

Display example:
LIVE MONITOR
30° ---- mm

**LIVE MONITOR to object
(FLEX MOUNT activated)**

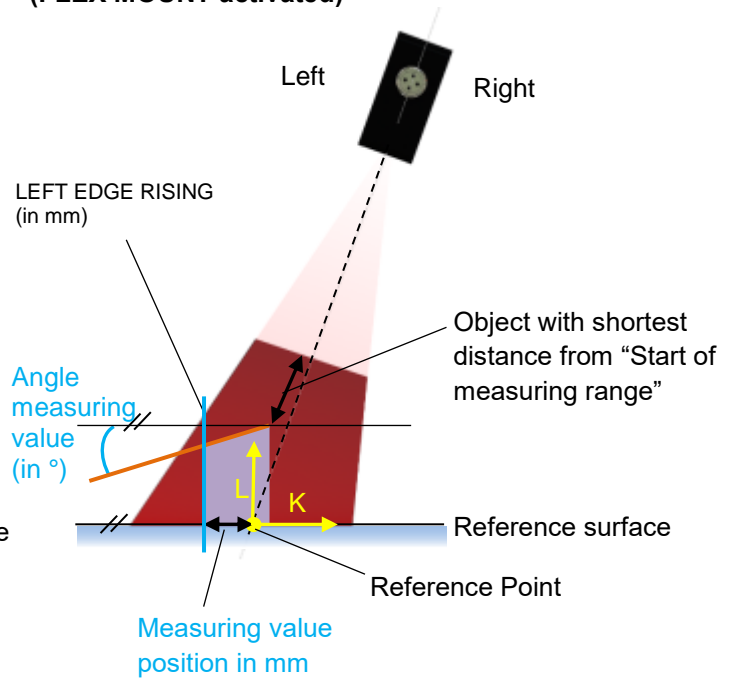

Display example:
LIVE MONITOR
15° 21.5mm

- “End of measuring range”¹ of the sensor represents the standard reference for angle measurement. Once the reference surface with FLEX MOUNT is Teached, “End of measuring range” is no longer valid. The new reference surface corresponds to 0° tilt angle.
- Displayed are for the edge position always the values for the object or the reference surface with the smallest distance to “Start of measuring range”¹.
- The requirements for the object with respect to the minimum width¹ and height¹ must be met.
- As soon LIVE MONITOR is active, the measuring field is set to maximum and the sensors outputs are set to “no object in measuring range”. After disabling LIVE MONITOR the last valid settings are applied again.

**NOTE**

An angle of 0° with FLEX MOUNT activated means that the top surface of the object is parallel to the reference surface.

**NOTE**

If there is no object within the measuring range during LIVE MONITOR or the minimum requirements for the object are not met, the sensor displays ----.

**NOTE**

When several objects are in the measuring range, the object with the shortest distance from the start of measuring range is the reference object.

¹ According to data sheet chapter 6.1

Displaying the tilt angle to the reference surface

For displaying the tilt angle of the sensor to the reference surface, FLEX MOUNT must not be activated and in the measuring field must not be an object. The output will be ---- for EDGE LEFT RISING of the object.

Finding the reference point without a teached reference surface

Once an object is within the measuring range, the position of LEFT EDGE RISING and the angle of the surface of the object relative to the axis "End of measuring range"¹ are displayed.

When moving the object into the direction of the assumed reference point until LEFT EDGE RISING displays 0mm, the reference point is found.

Finding the reference point with the teached reference surface

Although the sensor was mounted inclined, the sensor outputs an angle of 0° after teaching the reference surface with FLEX MOUNT. As soon there is an object within the measuring range, the sensor outputs the LEFT EDGE RISING of this object and also the difference of the angle from top of the object to the reference surface.

When moving the object into the direction of the assumed reference point until LEFT EDGE RISING displays 0mm, the reference point is found.

¹ According to data sheet chapter 6.1

5.4 MEAS TYPE

The PosCon OXH7 can determine the height of an object in various ways. The measuring value is calculated in mm with analog or RS485 output.



NOTE

If the MEAS TYPE is changed, SCALE OUT, DIGITAL OUT, FLEX MOUNT and FIELD OF VIEW are reset to the default setting.

Height

5.4.1 Avg HEIGHT

Average height of the object from the reference surface.

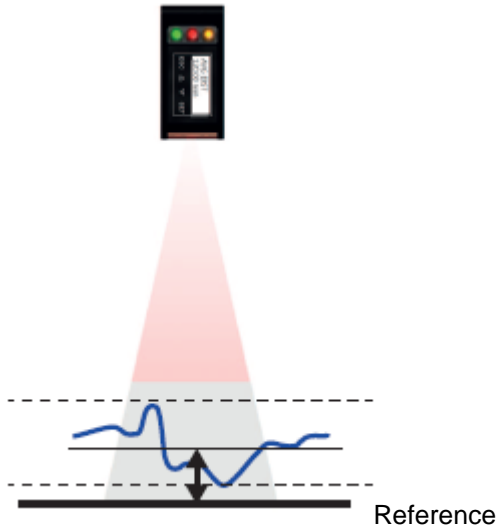

5.4.2 Max HEIGHT

Maximum height of the object from the reference surface.

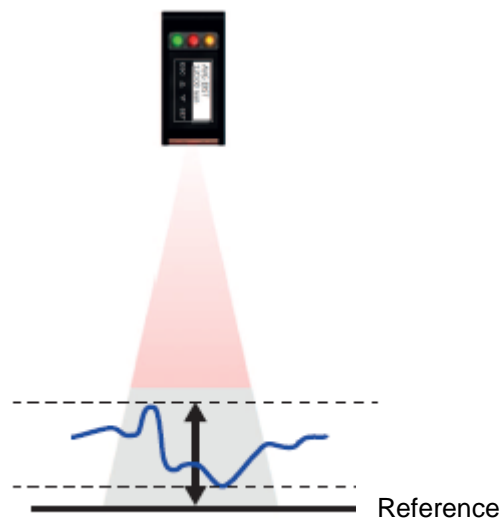

5.4.3 Min HEIGHT

Minimum height of the object from the reference surface.

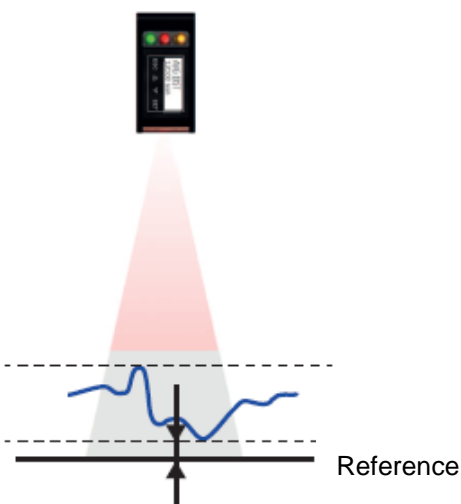

5.4.4 Delta HEIGHT

Maximum height of the object minus minimum height

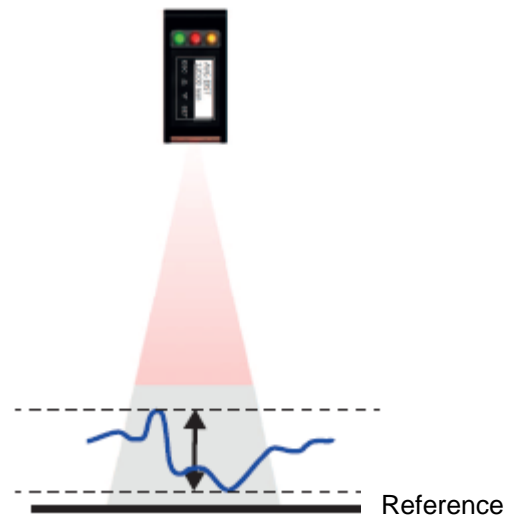

5.5 FLEX MOUNT (Function HEIGHT)

With FLEX MOUNT the reference surface will be Teached-In. With respect of its inclination, the sensor is able to calculate the height of objects correctly.

This function is recommended for the correct calculation of the height of objects with respect to the reference surface.

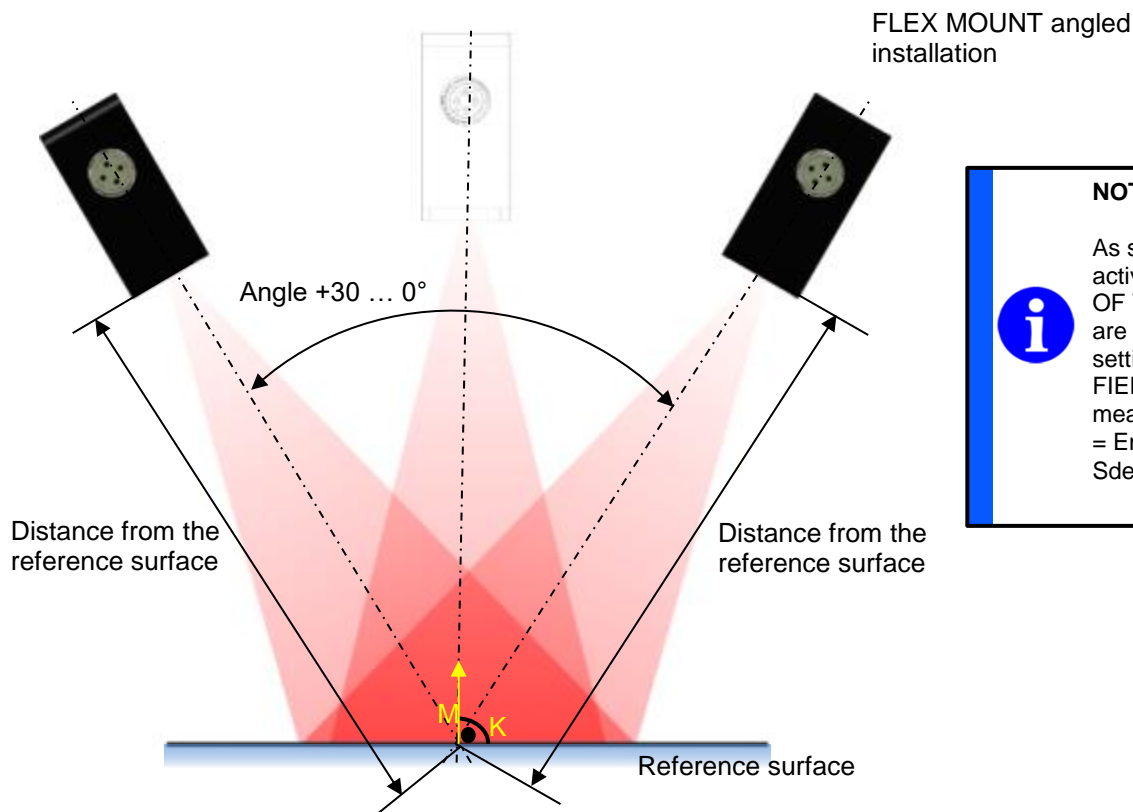

NOTE



As soon as FLEX MOUNT is activated, SCALE OUT, FIELD OF VIEW and DIGITAL OUT are reset to the standard settings (SCALE OUT and FIELD OF VIEW = maximum measuring field, DIGITAL OUT = End of measuring range Sde¹).

With FLEX MOUNT the inclination angle and the distance from the reference surface are automatically detected and saved in the sensor memory so the coordinate system can be rotated correctly. It is important that the reached surface is even and covers as much of the entire measuring range of the sensor as possible.

FLEX MOUNT is used, if...

- a standard installation (right angle to the reference surface or the object) is not present
- the reference surface is closer to the sensor than the End of the measuring range Sde
- the reference surface is to be automatically taught in and/or shifted
- the background is to be suppressed

Effects

- The coordinate system is rotated
- The reference surface is teached-in; the original sensor reference point is no longer valid
- Objects below the reference surface are ignored
- The axes are no longer referred to as X and Z, but as M and K
- The angle symbol  appears on the left of the display when FLEX MOUNT is active
- SCALE OUT, DIGITAL OUT and FIELD OF VIEW are reset to factory settings¹

¹ According to data sheet chapter 6.1

5.5.1 No

The FLEX MOUNT function is switched off by "No", the sensor can be mounted again at a right angle. If FLEX MOUNT is not activated, a 0° angle and "distance" = end of measuring range Sde¹ are set.

The angle symbol  disappears from the display.

NOTE



As soon as FLEX MOUNT is activated, SCALE OUT, FIELD OF VIEW and DIGITAL OUT are reset to the standard settings (SCALE OUT and FIELD OF VIEW = maximum measuring field, DIGITAL OUT = End of measuring range Sde¹).

5.5.2 Yes

FLEX MOUNT is activated in this menu.

Next, "Place the reference (REF)" is output by the sensor and then the sensor must be aligned to the reference surface (or the auxiliary plate if there is no reference surface). The reference surface must be within the sensor's measuring field (distance from sensor to reference surface less than distance from sensor to end of measuring range Sde). The reference surface must fulfill the requirements.

Auxiliary plate

To compensate for unevenness, a flat temporary auxiliary plate can be used for this process. It is placed on the reference surface during teaching-in and removed after the process.

This plate should be as flat as possible and must conform to the "minimum length of reference surface"¹. The plate must be positioned parallel to the reference surface below it. The thickness of this plate is not important as long as it is within the measuring field of the sensor. The thickness of the auxiliary plate can be removed at the end of the process by using "CORRECTION".

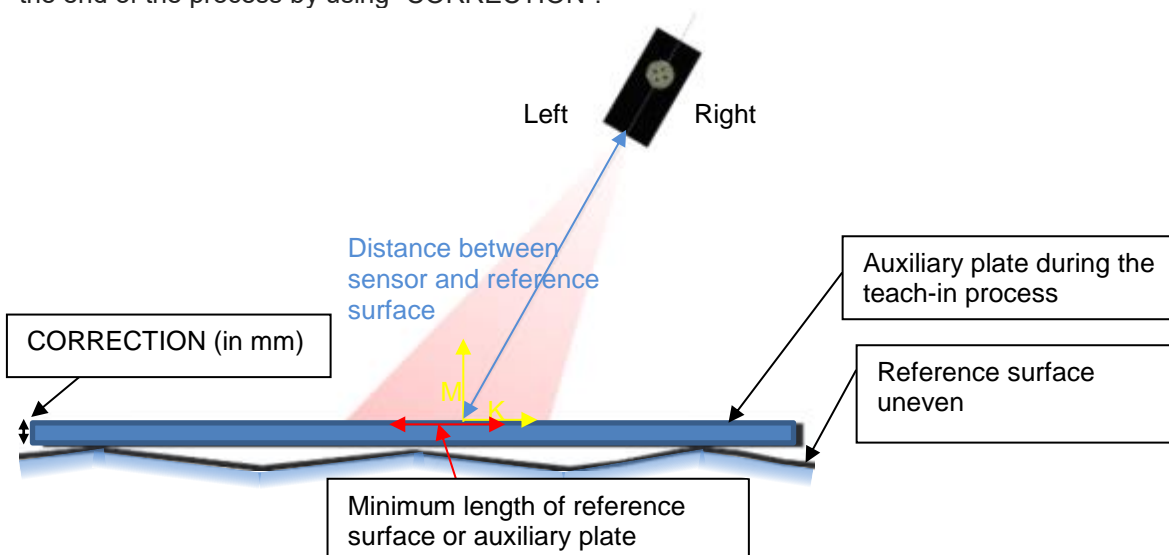

NOTE



The following menu items TEACH REF and CORRECTION must be completed so that FLEX MOUNT can be activated.





¹ According to data sheet chapter 6.1

5.5.3 TEACH REF

Conditions during TEACH REF

The following four conditions must be met during the reference surface teach-in process. If one of the symbols listed below appears on the display, it lights up red. The teaching process can only begin after elimination of all errors (the display no longer lights up red).



Symbol	Error description	Error correction
	Distance between sensor and reference surface not correct. The reference surface must be within the measuring range ¹ .	Correct distance between sensor and reference surface.
	The inclination angle of the sensor to the reference surface is too large. Maximum inclination angle $\pm 30^\circ$.	Correct inclination of the sensor.
	The reference surface is too uneven. The unevenness must not exceed the "max. reference surface unevenness" ¹ .	Use an auxiliary plate during teach-in process.
	The length of the reference surface is too small. It must conform to the "minimum reference surface length" ¹ .	Remove objects from the measuring field or use an auxiliary plate during the teach-in process.

Start the TEACH REF teach-in process by pressing SET for 2 seconds.

NOTE



To ensure correct teach-in of the reference surface, CORRECTION must always be completed after the angle teach-in process. This is the only way to determine the effective reference surface with due regard to the thickness of the auxiliary plate.

¹ According to data sheet chapter 6.1

5.5.4 CORRECTION

The reference surface can be moved in height with CORRECTION after teaching. This is useful when using an auxiliary plate, or if the reference surface has to be hidden.

Using an auxiliary plate

In this menu item, the reference surface is defined with due regard to the thickness of the auxiliary plate (optional).

The surface taught in under TEACH REF is always the basis for this.

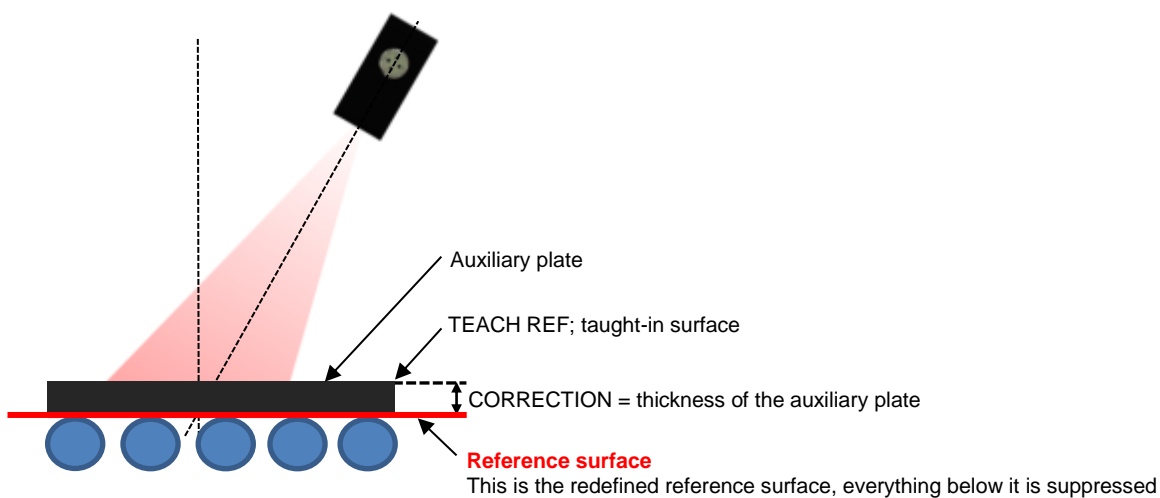

Example:

The display lights up red during TEACH REF because of unevenness in the reference surface. This reference surface does not comply with one or more conditions.

A 10 mm thick auxiliary plate is therefore placed on the reference surface for the duration of the teach-in process. Following activation of FLEX MOUNT and TEACH REF on this auxiliary plate, the auxiliary plate must be specified with +10 mm in menu item CORRECTION. After completion of FLEX MOUNT, the reference surface is now situated where the original (uneven) reference level was.

Hide the reference surface

The fact that everything is hidden below the reference surface, the originally taught-in reference surface can be hidden by shifting the reference surface upwards.

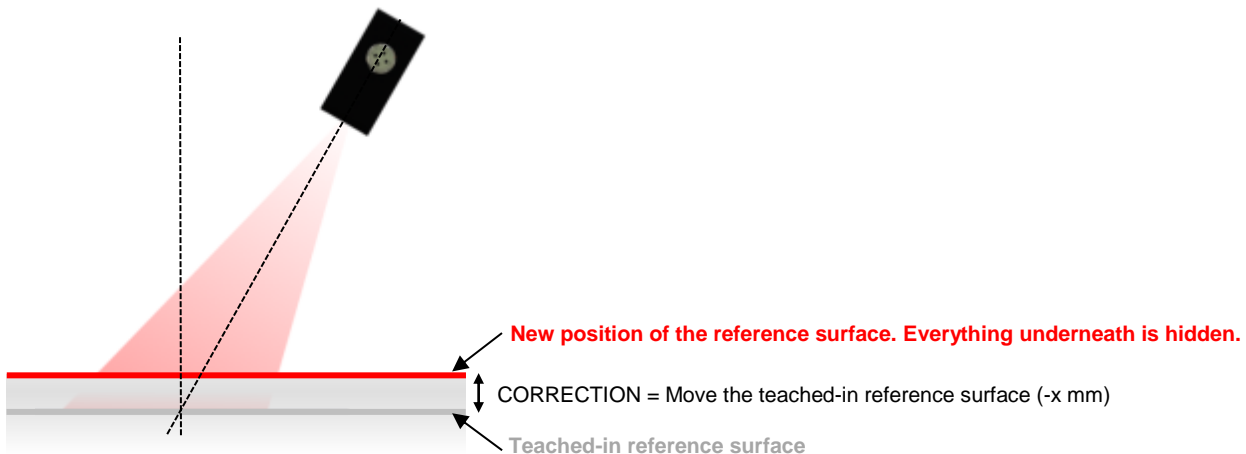

Example:

While using the Delta Height function (Maximum height minus minimum height of the object) the taught-in reference surface affects the measurement result.

With setting CORRECTION -5 mm, the reference surface is placed over the originally Taught reference surface, which the surface disappears and no longer affects the measurement result.



NOTE

If the reference surface should not be moved, the item CORRECTION must be saved with 0 mm by pressing SET for 2 seconds.



NOTE

As soon as FLEX MOUNT is activated, SCALE OUT, FIELD OF VIEW and DIGITAL OUT are reset to the standard settings (SCALE OUT and FIELD OF VIEW = maximum measuring field, DIGITAL OUT = End of measuring range Sde).



NOTE

If the reference surface is displaced by entering a negative value upwards with CORRECTION, then the measured value of the functions Max, Min and Average is reduced by this value, or falsified. For these functions OFFSET in ANALOG OUT Menu should be preferred. With OFFSET the reference surface at the originally learned point remains.

5.6 OBJECT

To improve sensitivity to dark objects, the exposure time can be increased. This also changes the measuring repetition time.

5.6.1 Object: Bright (Reflectivity > 18%, white-grey)

Exposure time (Pulse duration)	Short ¹
-----------------------------------	--------------------

5.6.2 Object: Dark (Reflectivity 6...18%, dark grey-black)

Exposure time (Pulse duration)	Long ¹
-----------------------------------	-------------------

5.7 PRECISION

By enabling filtering, the noise can be reduced and thereby the resolution can be increased.

Standard = normal resolution¹²
 High = approx. twice the normal resolution¹²
 Very high = approx. four times the normal resolution¹²

5.7.1 Influences of the filter PRECISION

The higher precision is set, the more measuring speed is reduced (response and the release time are increased). The measuring frequency is not affected by using this filter.

PRECISION utilizes a moving median and a moving average filter.

Moving Median

The median of a finite list of numbers can be found by arranging all the observations from lowest value to highest value and picking the middle one (e.g., the median of {3, 3, 5, 9, 11} is 5). The number of samples stored in the array is called "Sample size" (e.g. {3, 3, 5, 9, 11} = 5 values). When a new sample is added the oldest sample is removed (Moving filter). A sudden change of the measured values will only effect the output after more than half of the samples stored resemble the new value (e.g. sample size=5 -> 3 samples until output is effected).

¹ According to data sheet chapter 6.1

² Dependent upon object to be measured

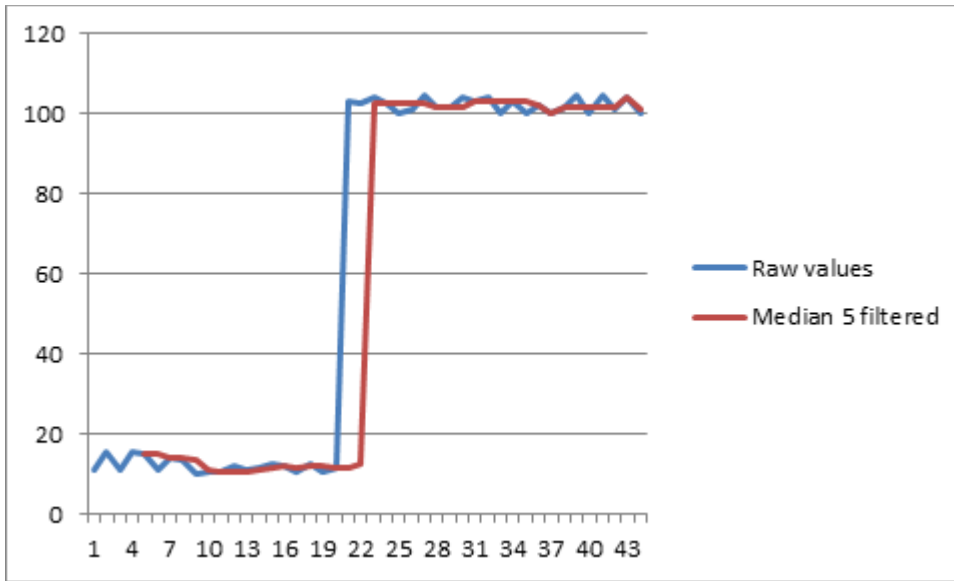

The diagram shows the effects of the median (sample size 5). The filter is used to suppress errors. The output changes after a defined number of samples (sample size/2). The measurement frequency is not affected by this filter, but rather the response time.

Moving average

The output of the moving average filter is the average of all values found in the array with the defined sample size. When a new sample is added, the oldest sample is removed (Moving filter).

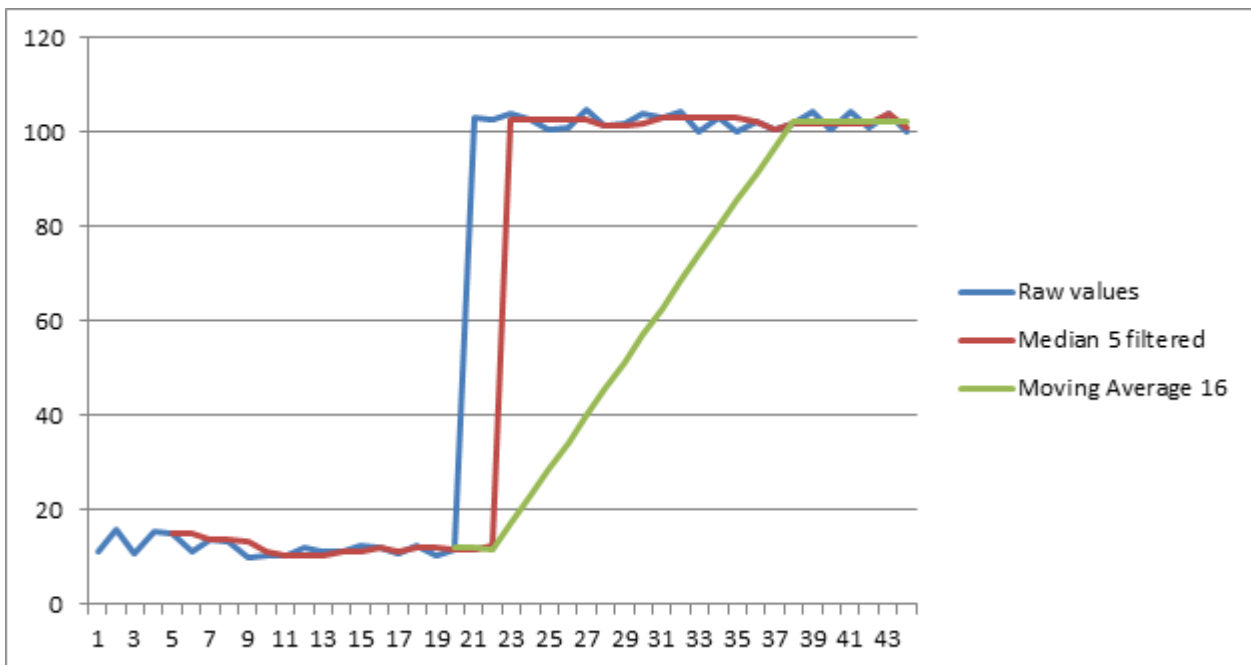

As visible in the diagram, the moving average softens the output. In contrast to the median filter, values at the output can be values that have never been measured. The measurement frequency is not affected by this filter, but rather the response time.

Number of samples until the correct value will be output:

- In PRECISION mode HIGH, the distance has to be stable for 2 + 0 samples for the output to show the current value.
- In precision mode very high, the distance has to be stable for 2 + 16 samples for the output to show the current value.

Example

Calculation of the response time with measuring frequency 500 Hz, PRECISION = High

$$1 / 500 \text{ Hz} = \mathbf{0.002 \text{ s}}$$

$$\text{Median} = 7 / 2 \text{ (Formula: Samples / 2)} = \mathbf{4}$$

$$\text{Average} = \mathbf{16}$$

$$\text{Response time} = \mathbf{0.002 * (4 + 16) = 0.04 \text{ s} = 40 \text{ ms}}$$

5.8 FIELD OF VIEW

The width of the measuring field can be limited with the FIELD OF VIEW function. All measuring values outside the set measuring field are ignored. This is particularly useful if, for example, the measuring field contains an unwanted object that should not be detected.

The measuring field is adapted by software so the width of the visible laser beam does not change.

5.8.1 Manual limitation of the measuring field

For full flexibility, every value in the measuring field can be individually adjusted. The modified measuring field need not be symmetrical. Even a single limit, e.g. LIMIT LEFT, can be restricted.

- LIMIT LEFT
- LIMIT RIGHT

Standard installation

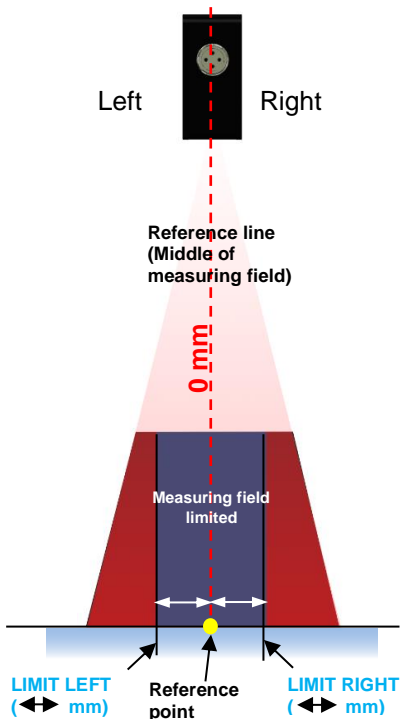

Angled installation (FLEX MOUNT)

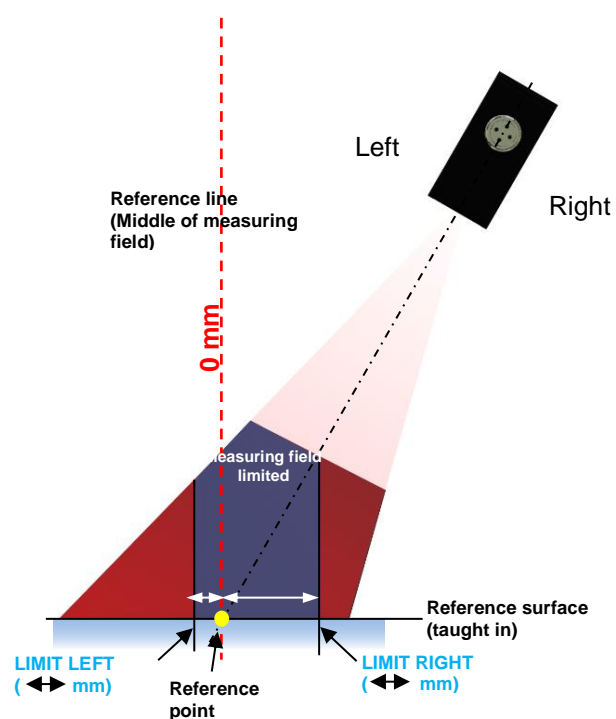

NOTE



The LIVE MONITOR mode can be used to find the reference point. This function displays the LEFT EDGE RISING of objects. Now an object is slowly pushed toward the presumed zero point. The zero point is reached when the value 0 mm is shown on the sensor display.

NOTE



If a reference surface is taught in with FLEX MOUNT, the reference point of that taught-in surface represents 0. LIMIT LEFT and LIMIT RIGHT are specified from there.

5.8.2 LIMIT LEFT

Limitation of the left side of the measuring field in mm, measured from the reference point.

5.8.3 LIMIT RIGHT

Limitation of the right side of the measuring field in mm, measured from the reference point.

NOTE

The measuring field width (LIMIT LEFT to LIMIT RIGHT) must be at least 2 mm.

5.8.4 FIELD OF VIEW

"Set maximum values" resets all adjustments of the measuring field to the standard settings (maximum measuring field).

NOTE

If with FLEX MOUNT a new reference surface is teached-in, the preset left and right limits are deleted and the modified measuring field is reset to the maximum measuring field.

5.9 ANALOG OUT

5.9.1 SCALE OUT

In the factory setting, the analog output runs across the entire measuring range (start of measuring range S_{dc} - end of measuring range S_{de}) from 0...10V (voltage mode) or from 4...20mA (current mode).

The start and end of the measuring range can be reset with SCALE OUT, reducing the measuring field and changing the calibration curve.

The smaller measuring field improves the measurement repetition time, i.e., the measuring frequency is increased.

*The minimum window size (distance from end of the measuring range S_{de} - start of measuring range S_{dc}) must be greater than 5% of the "end of measuring range" value.

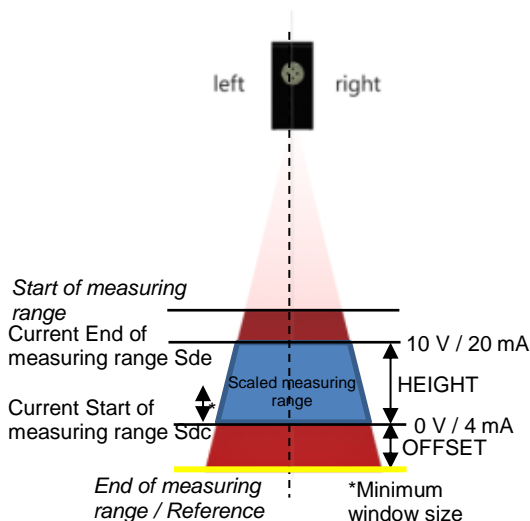

5.9.1.1 OFFSET

The value in mm at which the sensor should have the minimum analog output value of 0V or 4 mA is specified here.

OFFSET \geq Start of measuring range

OFFSET \leq End of measuring range – minimum window size*

5.9.1.2 HEIGHT

The value in mm at which the sensor should have the maximum analog output value of 10V or 20 mA is specified here. OFFSET represents the basis for this value.

HEIGHT \leq End of measuring range

HEIGHT \geq Start of measuring range + minimum window size*



NOTE

The measuring cycles can be shortened by reduction of the window size, i.e. this increases the measuring frequency, according to data sheet chapter 6.1.

Example: SCALE OUT with HEIGHT function

At an object height of 30 mm, the sensor should display 20 mA and 4 mA at a height of 5 mm.

- Set OFFSET to 5 mm
- Set HEIGHT to 30 mm

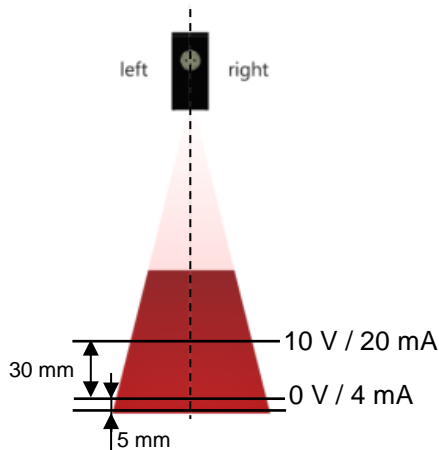
5.9.1.3 SET MAX VALUES

SCALE OUT is reset to the standard setting (maximum measuring field) with the "set max values" command.

5.9.2 ANALOG OUT

The analog output can be set from current to voltage.

5.9.3 CHARACTERISTIC

The analog characteristic curve can be inverted. With a positive output slope, the signal increases with an increasing measuring value. For the negative slope the output signal decreases with an increasing measuring value.

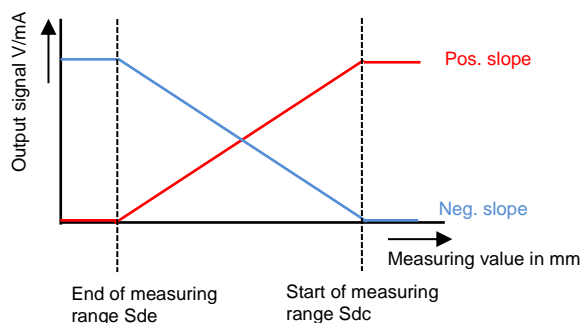

5.10 DIGITAL OUT

With Pin 4 (out), the user has a configurable switching output.

It can be defined as a single switching point (threshold) or a window. Pin 4 is activated when the value (point or window) is exceeded or not reached (active high or active low depending on the setting).

The switching points can only be placed inside the active, preset measuring field (note SCALE OUT). There is a hysteresis¹ for a reliable switching signal.

The window must be larger than “Minimal switching window” according to the sensors data sheet.

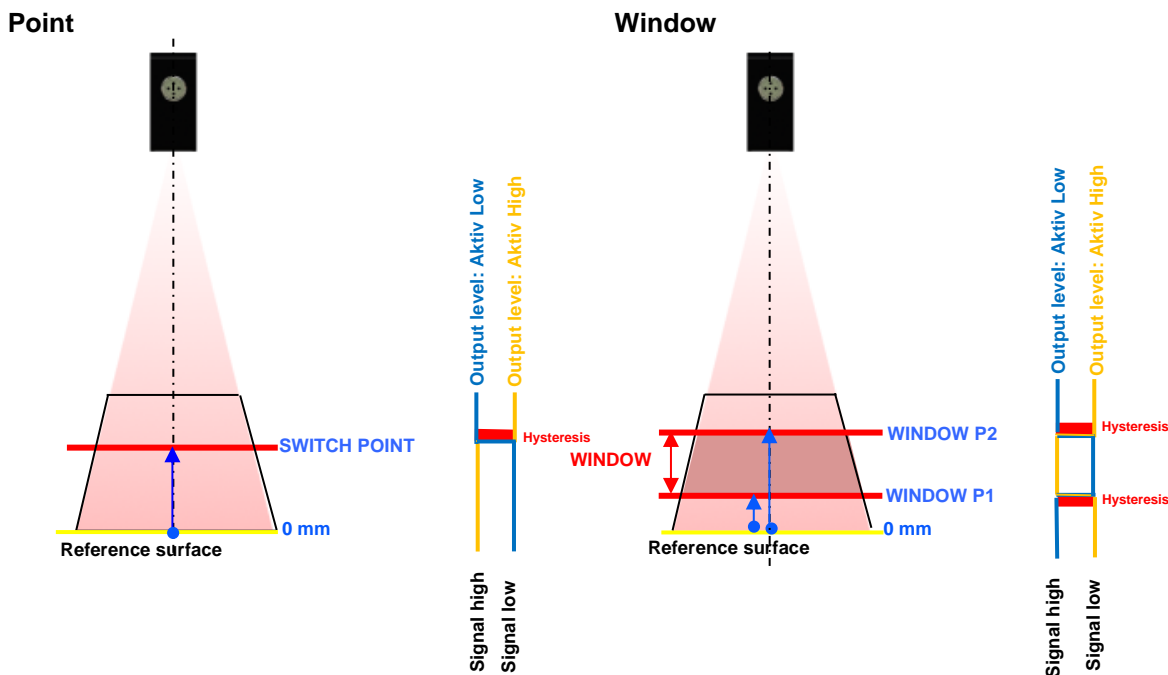

5.10.1 DIGITAL OUT

Whether Pin 4 is to be operated as a **threshold** (with a switch point) or as a **window** (window function) is defined here.

5.10.2 SWITCH POINT

The switch point is selected in mm using the arrow keys. The point must lie within the measuring range (between start of measuring range S_{dc}^1 and end of measuring range $S_{de}^1 - 2x$ hysteresis¹).

¹ According to data sheet chapter 6.1

5.10.3 WINDOW P1

Window point 1 (for the WINDOW mode) is selected in mm using the arrow keys. The point must lie within the measuring range (greater than start of measuring range $S_{dc}^1 + 2x$ hysteresis¹).

5.10.4 WINDOW P2

Window point 2 (for the WINDOW mode) is selected in mm using the arrow keys. The point must lie within the measuring range (less than end of measuring range $S_{de}^1 - 2x$ hysteresis¹).

5.10.5 LEVEL

The output level can be inverted with **active high** or **active low** here.

NOTE



If MEAS TYPE is changed, the switching output settings are discarded. The factory settings are restored for DIGITAL OUT = End of measuring range S_{de}^1 .

¹ According to data sheet chapter 6.1

5.11 SYSTEM

5.11.1 RS485 BAUD

The sensor can be operated with three different baud rates:

- 38400
- 57600
- 115200

5.11.2 RS485 ADDR

Every sensor has its own RS485 address, allowing the selected sensor to be addressed directly. This address is preset to 001 in every sensor and the 3 digits can be changed here. Two sensors in the same network must not have the same number, to prevent the occurrence of bus conflicts. No more than 32 sensors may be connected to one bus.

5.11.3 ANALOG OUT

The analog output can be reset to voltage or current, depending on purpose.

See the Section "Interfaces and output --> Analog signal output".

- Current
- Voltage

5.11.4 DISPLAY LIGHT

The display background illumination automatically switches off after the set time or remains switched on. The countdown begins as soon as the keys for an operation are locked (key symbol).

- OFF 5 min.
- OFF 10min.
- OFF 20min.
- Always ON

5.11.5 SENSOR INFO

The sensor type and serial number are displayed here to enable clear identification of the sensor.

- SENSOR TYPE
- SERIAL NUMBER

5.11.6 Language

Language selection:

- English
- Deutsch
- Italiano
- Français

5.11.7 RESET

This resets all settings in sensor parameters to the factory settings.

MEAS TYPE	= Delta HEIGHT
OBJECT	= Bright
PRECISION	= Standard
SCALE OUT	= Max. values
FLEX MOUNT	= Not activated (standard installation)
FIELD OF VIEW	= Max. values
DIGITAL OUT	= Threshold (end of measuring range Sde, active high)
RS485 lock	= 1 (activated)
RS485 BAUD RATE	= 57600
RS485 BAUD ADR	= 001
ANALOG OUT	= Current
DISPLAY LIGHT	= OFF after 5min.
LANGUAGE	= English

NOTE



With "Reset", the current configuration in the sensor is overwritten. However, all stored settings are deleted from the sensor memory. The factory settings will be restored.

5.12 SETTING

The settings entered in the sensor can be applied, stored or displayed here.

5.12.1 APPLY

The settings saved under SAVE can be activated here.

- Setting 1
- Setting 2
- Setting 3

5.12.2 STORE

The settings entered in the sensor can be stored here.

Three storage spaces are available.

- Setting 1
- Setting 2
- Setting 3

5.12.3 SHOW

SHOW displays the setting values.

SHOW ACTIVE

Displays the active settings.

SHOW SETTING 1-3

Displays the settings stored in storage spaces 1-3

The values are displayed successively; it is possible to jump to the next value using DOWN.



MEAS TYPE
OBJECT
PRECISION
SCALE OUT- Dist NEAR
SCALE OUT- Dist FAR
FLEX MOUNT
LIMIT LEFT
LIMIT RIGHT
SWITCH POINT
WINDOW P1
(WINDOW P2)
OUTPUT LEVEL
ANALOG OUT

6 Function and definition

6.1 Sensors data sheet

General data	PosCon OXH7 11159406 OXH7-11159406	PosCon OXH7 11161809 OXH7-11161809
Function	Object height	Object height
Function: FLEX MOUNT	Yes	Yes
Function: FIELD OF VIEW	Yes	Yes
Measuring range (distance)	100...150 mm	100...500 mm
Start of measuring range Sdc	100	100
End of measuring range Sde	150	500
Measuring range (width)	48...72 mm	13 ...66 mm
Measuring field width right @ Sde	+36 mm	+33 mm
Measuring field width left @ Sde	-36 mm	-33 mm
Blind region	0...100 mm	0...100 mm
Measuring frequency - OBJECT bright (approx. 90% Refl.) - OBJECT dark (approx. 6% Refl.)	244...570 Hz ¹⁴ 192...342 Hz ¹⁴	440...1540 Hz ¹²⁴ 340...770 Hz ¹²⁴
Response time - OBJECT bright (approx. 90% Refl.) - OBJECT dark (approx. 6% Refl.)	3.5...8.2 ms ¹⁴ 5.8...10.4 ms ¹⁴	1.3...4.5 ms ¹²⁴ 2.6...5.8 ms ¹²⁴
Resolution AVG DIST (max. measuring field width)	8...16 μm ³⁴⁵ (Without filter) 4...8 μm ³⁴⁵⁶ (With filter Precision high) 2...4 μm ³⁴⁵⁶ (With filter Precision very high)	15...55 μm ³⁴⁵ (Without filter) 8...28 μm ³⁴⁵⁶ (With filter Precision high) 4...25 μm ³⁴⁵⁶ (With filter Precision very high)
Resolution MIN / MAX DIST	23...48 μm ³⁴ (Without filter) 12...24 μm ³⁴⁶ (With filter Precision high) 6...12 μm ³⁴⁶ (With filter Precision very high)	70...150 μm ³⁴ (Without filter) 45...75 μm ³⁴⁶ (With filter Precision high) 25...45 μm ³⁴⁶ (With filter Precision very high)
Repeatability AVG DIST (max. measuring field width)	8 μm ³⁴⁵ (Without filter) 4 μm ³⁴⁵⁶ (With filter Precision high) 2 μm ³⁴⁵⁶ (With filter Precision very high)	10...40 μm ³⁴⁵ (Without filter) 5...25 μm ³⁴⁵⁶ (With filter Precision high) 4...20 μm ³⁴⁵⁶ (With filter Precision very high)
Repeatability MIN / MAX DIST	16 μm ³⁴ (Without filter) 8 μm ³⁴⁶ (With filter Precision high) 4 μm ³⁴⁶ (With filter Precision very high)	30...90 μm ³⁴ (Without filter) 20...70 μm ³⁴⁶ (With filter Precision high) 15...60 μm ³⁴⁶ (With filter Precision very high)
Linearity error	± 20 μm ³⁴⁵⁷	± 100 μm ³⁴⁵⁸
Temperature drift	± 0.04% Sde/K ³⁴⁵	± 0.04% Sde/K ³⁴⁵
PRECISION filter values:	Median Average	Median Average
Standard	Off Off	Off Off
High	3 Off	3 Off
Very High	3 16	3 16
Smallest detectable object	0.7...1.1 mm	1...5 mm
Laser class	1	2
Max. reference surface unevenness (rms)	0.25 mm	1 mm
Min. reference surface length	24 mm	12 mm
LIVE MONITOR:		
Minimum object height	4 mm	10 mm
Minimum object width	4 mm	12 mm

¹ Measuring rate depends on the measuring field (distance). Min value: Maximum measuring field; Max. Value: 20% of the measurement field

² Measuring rate depends on the measuring field (width)

³ Measurement with Baumer standardized measuring equipment and targets depending on measuring range (distance)

⁴ Measurement on 90% remission (white)

⁵ Measurement with measuring type average

⁶ With active filtering

⁷ Measuring range (distance) 100...112.5 mm

⁸ Measuring range (distance) 100...200 mm

Digital output hysteresis	0.5% of Sd (switch point)	1 % of Sd (switch point)
Minimal switching window	2 mm	10 mm
Power on indication	Green LED	Green LED
Output indicator	Yellow LED / red LED	Yellow LED / red LED
Light source	Red laser diode, pulsed	Red laser diode, pulsed
Setting	Touch display, RS485	Touch display, RS485

Electrical data	PosCon OXH7 11159406 OXH7-11159406	PosCon OXH7 11161809 OXH7-11161809
Voltage supply range +Vs	15 ... 28 VDC	15 ... 28 VDC
Max. supply current (without load)	120 mA	150 mA
Output circuit	Analog and RS485	Analog and RS485
Output signal	4 ... 20 mA / 0 ... 10 VDC (adjustable)	4 ... 20 mA / 0 ... 10 VDC (adjustable)
Switching output	Push-pull	Push-pull
Output function	Out 1 / alarm	Out 1 / alarm
Output current	< 100 mA	< 100 mA
Baud rate	38400 / 57600 / 115200	38400 / 57600 / 115200
Reverse polarity protection	Yes, Vs to GND	Yes, Vs to GND
Short circuit protection	Yes	Yes

Mechanical data	PosCon OXH7 11159406 OXH7-11159406	PosCon OXH7 11161809 OXH7-11161809
Width / Height / Length	26 / 74 / 55 mm	26 / 74 / 55 mm
Design	Rectangular, front view	Rectangular, front view
Housing material	Aluminum	Aluminum
Front (optics)	Glass	Glass
Connection method	Plug M12 8-pole	Plug M12 8-pole
Weight	130 g	130 g

Ambient conditions	PosCon OXH7 11159406 OXH7-11159406	PosCon OXH7 11161809 OXH7-11161809
Ambient light immunity	< 35 kLux	< 35 kLux
Operating temperature	-10 ... +50 °C	-10 ... +50 °C
Storage temperature	-25...+75 °C	-25...+75 °C
Protection class	IP 67	IP 67
Vibration resistance (sinusoidal)	IEC 60068-2-6:2008 7.5mm p-p for f = 2 - 8Hz 2g for f = 8 – 200Hz, or 4g for 200 – 500Hz	IEC 60068-2-6:2008 7.5mm p-p for f = 2 - 8Hz 2g for f = 8 – 200Hz, or 4g for 200 – 500Hz
Resonance test	IEC 60068-2-6:2008 1.5mm p-p for f = 10 - 57Hz , 10 cycles for each axis 10g for f = 58 -2,000Hz, 10 cycles for each axis	IEC 60068-2-6:2008 1.5mm p-p for f = 10 - 57Hz , 10 cycles for each axis 10g for f = 58 -2,000Hz, 10 cycles for each axis
Vibration resistance (random)	IEC 60068-2-64:2008 Spectrum: 0.1 g ² /Hz for 20 – 1,000Hz, 30 minutes / axis (>10g RMS)	IEC 60068-2-64:2008 Spectrum: 0.1 g ² /Hz for 20 – 1,000Hz, 30 minutes / axis (>10g RMS)
Shock resistance	IEC 60068-2-27:2009 50g / 11ms or 100g / 6ms, 10 shocks in each axis and each direction 50g / 11ms or 100g / 6ms, 5,000 shocks in each axis and each direction	IEC 60068-2-27:2009 50g / 11ms or 100g / 6ms, 10 shocks in each axis and each direction 50g / 11ms or 100g / 6ms, 5,000 shocks in each axis and each direction
Impact resistance	IEC 60068-2-27 50g / 11ms or 100g / 6ms, 4,000 shocks in each axis and each direction	IEC 60068-2-27 50g / 11ms or 100g / 6ms, 4,000 shocks in each axis and each direction

Optical properties	PosCon OXH7 11159406 OXH7-11159406	PosCon OXH7 11161809 OXH7-11161809
Light source	AlGaInP-Laser Diode	InGaAlP-Laser Diode
Wavelength	656 nm	660 nm
Operational mode	pulsed	pulsed
Pulse duration bright mode dark mode	0.6 ms 1.8 ms	0.15 ms 0.8 ms
Pulse period bright mode dark mode	>1.7 ms >2.9 ms	>0.65 ms >1.3 ms
Total emitted pulse power	3 mW	10 mW
Beam shape	elliptical (focused to laser line)	elliptical (focused to laser line)
Focus distance d_f	125 mm	350 mm
Beam size @ exit window perpendicular parallel	2.5 mm 7.5 mm	2.2 mm 5.8 mm
Beam size @ focus perpendicular parallel	< 0.1 mm $L = 73$ mm	< 0.4 mm $L = 65$ mm
Beam divergence perpendicular δ_{\perp} parallel δ_{\parallel}	16.0 mrad 30.2°	4.8 mrad 9.4°
Nominal ocular hazard distance (NOHD) ¹	NA	1.5 m
Laser classification (per IEC 60825-1/2014)	Laser Class 1	Laser Class 2

6.1.1 Beam divergence

Perpendicular plane:

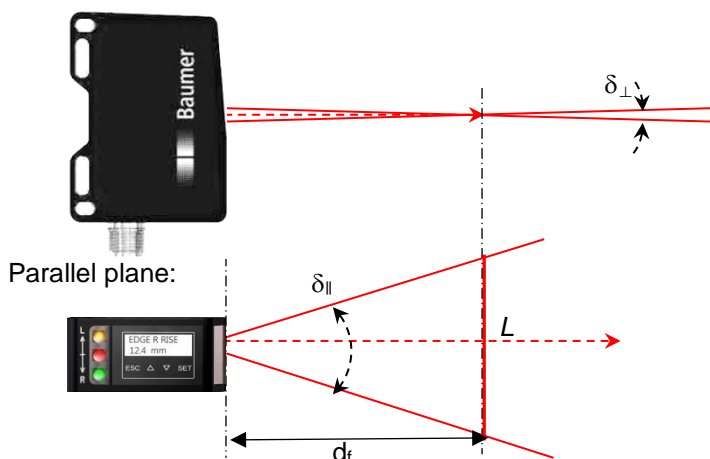

¹ Beyond the nominal ocular hazard distance, the accessible radiation exposure is below the limit of laser class 1

6.1.2 Dimensions

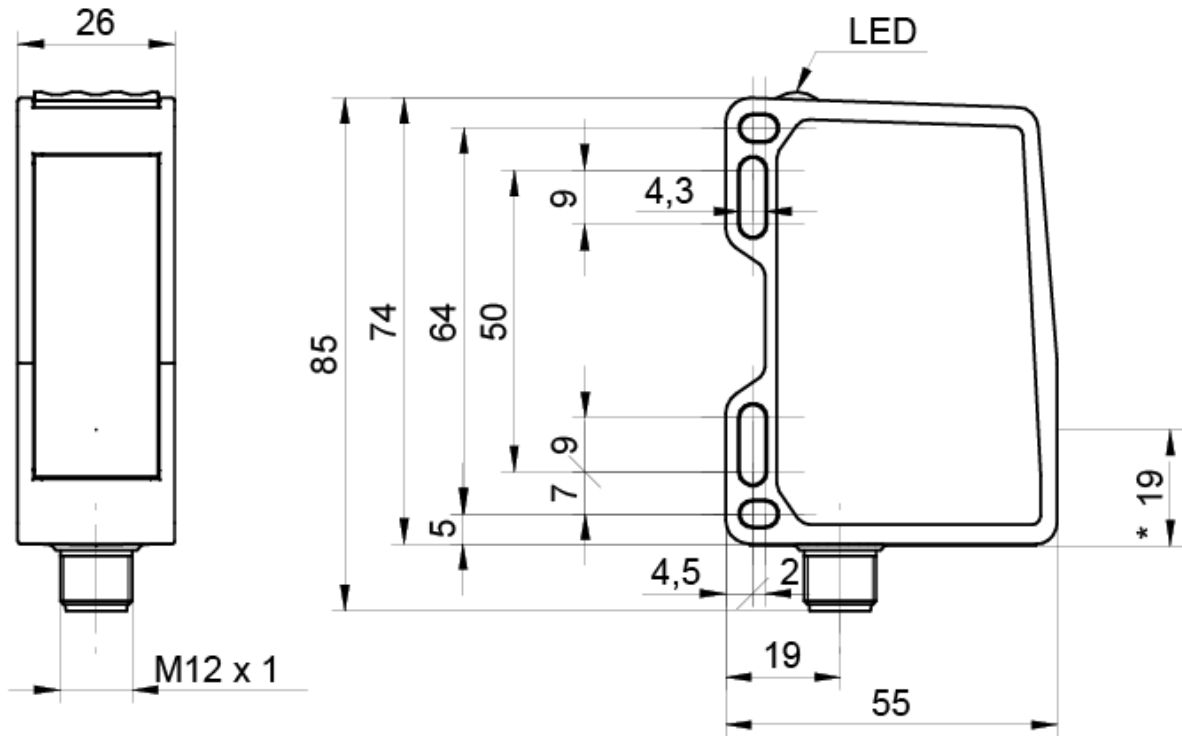

*Optical axis

6.2 Functional principle

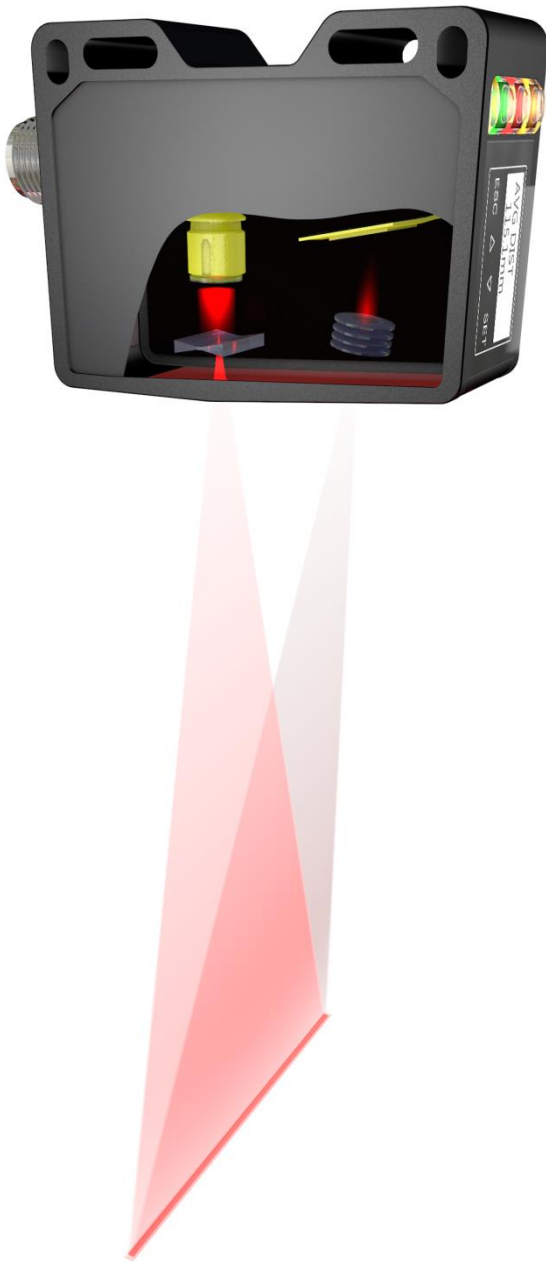

The sensor works on the laser triangulation principle. By means of special optics, a laser beam is enlarged into a line and projected to the surface of the object to be measured. Using the multi-lens system, the reflected light from this laser line is projected onto a matrix. From this matrix image, a controller calculates the distance to every individual measuring point. The measuring value is calculated in accordance with the selected function. Thanks to the new Baumer technology, the object height is always output correctly, independent of the object's position in the measuring field.

6.2.1 qTarget

The measuring field is aligned with the housing reference surfaces at the factory. The beam position in every sensor is in exactly the same spot, which makes planning and sensor replacement very easy.

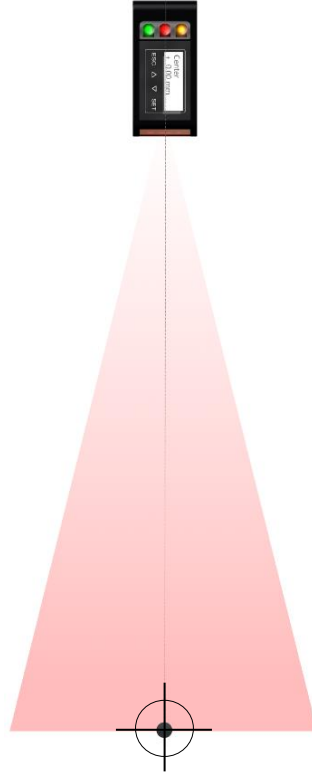

6.3 Measuring repetition time and response time

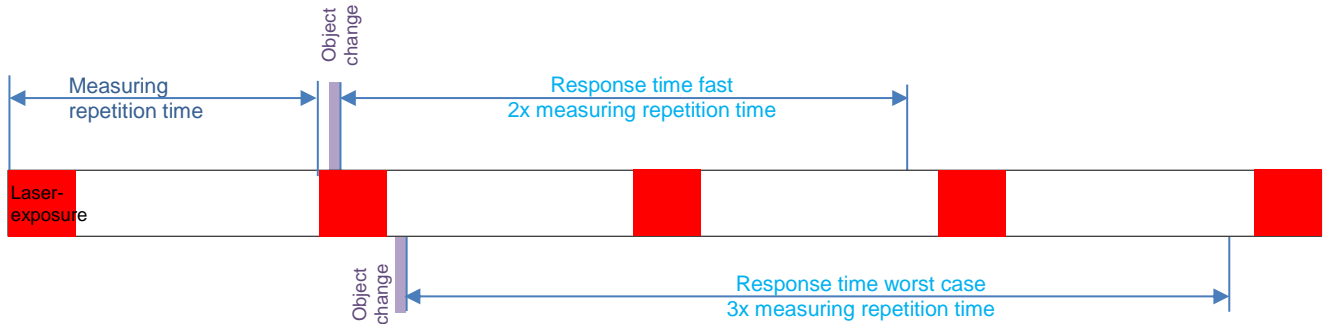

6.3.1 Measuring repetition time

The measuring repetition time (specified in milliseconds) is the time between two exposure times.

Measuring repetition time = 1/Measuring frequency in Hz'

Example:

Measuring frequency = 100 Hz

$1/100 \text{ Hz} = 0.01 \text{ ms}$

Measuring repetition time = 0.01 ms

6.3.2 Response time

Response time is called the time in which the sensor has output the new measured value after an object changed his position.

Typically it is about 2-3x measuring repetition time.

When the position of the object has changed during the exposure time, the response time is the fastest, ie about the 2x measuring repetition time.

At the worst case, if the object position has changed shortly after an exposure time, the response time is 3x measuring repetition time.

6.3.3 Response time when using Sync-In

If the Sync-In input is High, and then to start a measurement, is set to Low, the sensor starts with the exposure process.

This means that if the Sync-In is in use, the response time always is 2x the measuring repetition time.

6.4 Hysteresis

6.4.1 Definition of the Hysteresis

The Hysteresis is the difference between switch-on and switch-off point. It is defined as a percentage of the sensing distance Sd . Without hysteresis H , objects could at the limit of the switching points lead to ceaseless on/off switching or bouncing.

6.4.2 Calculating the hysteresis

The absolute hysteresis H can be calculated by taking the Hysteresis h value from the data sheet.

$$H = Sd \times h$$

For PosCon OXH7 sensors should be noted that the upper range Sde can be changed by using the FLEX MOUNT function. If FLEX MOUNT is active, the current value Sde can be read in the FLEX MOUNT menu.

$$Sd = Sde - \text{Switch point}$$

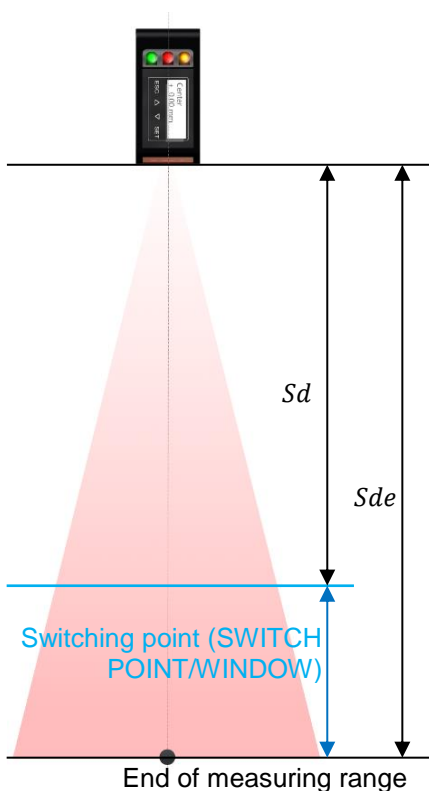

6.4.3 Characteristics of the switching output at SWITCH POINT

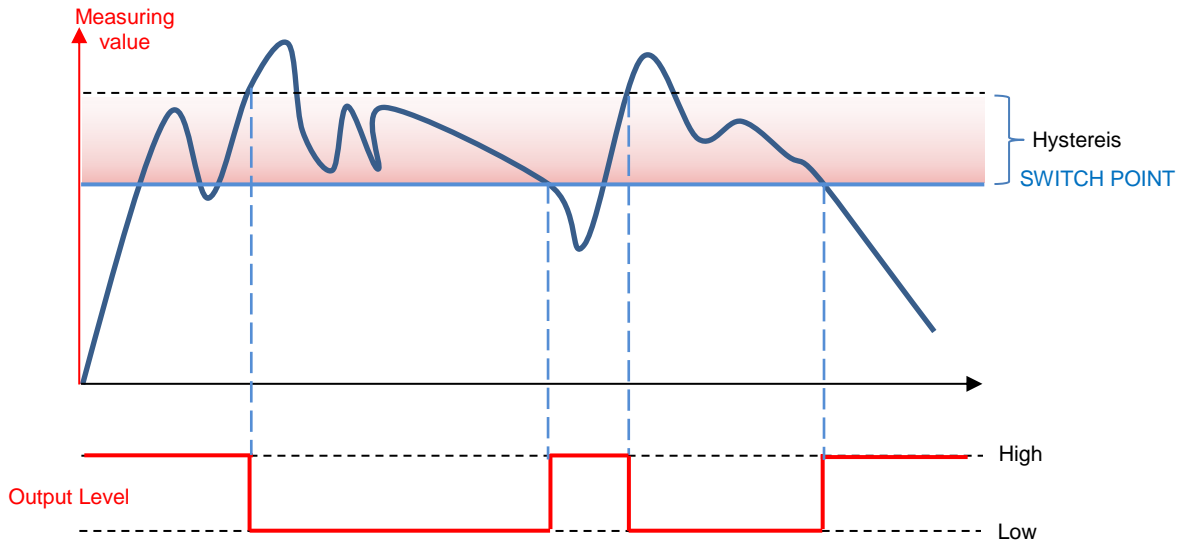

6.4.4 Characteristics of the switching output at WINDOW

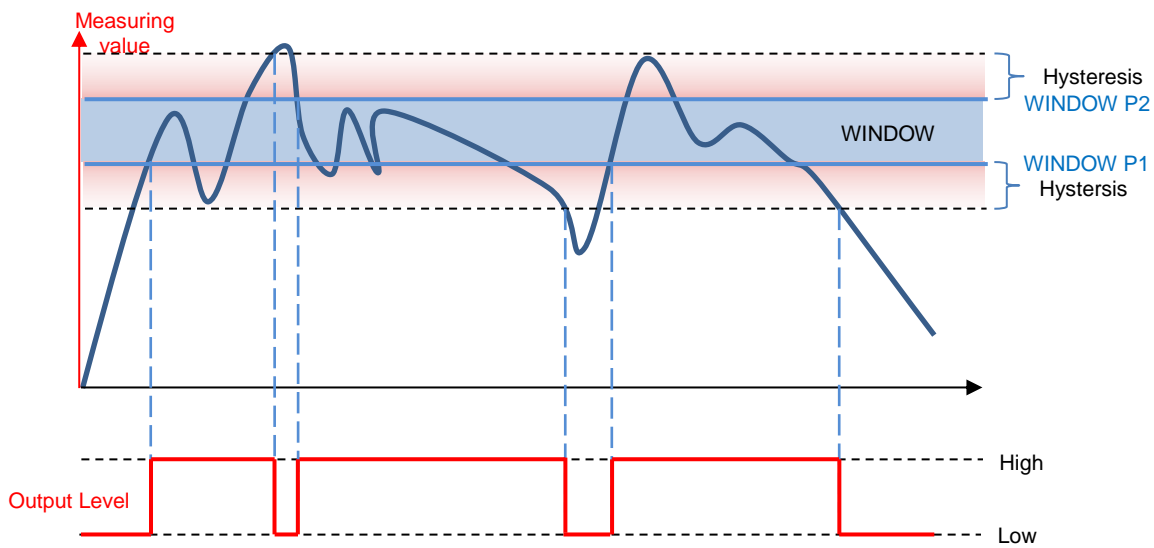

6.5 Object to be measured

6.5.1 Smallest detectable object

For an object to be reliably detected, it must conform to the minimum object width¹. This minimum object width varies with the distance from the sensor.

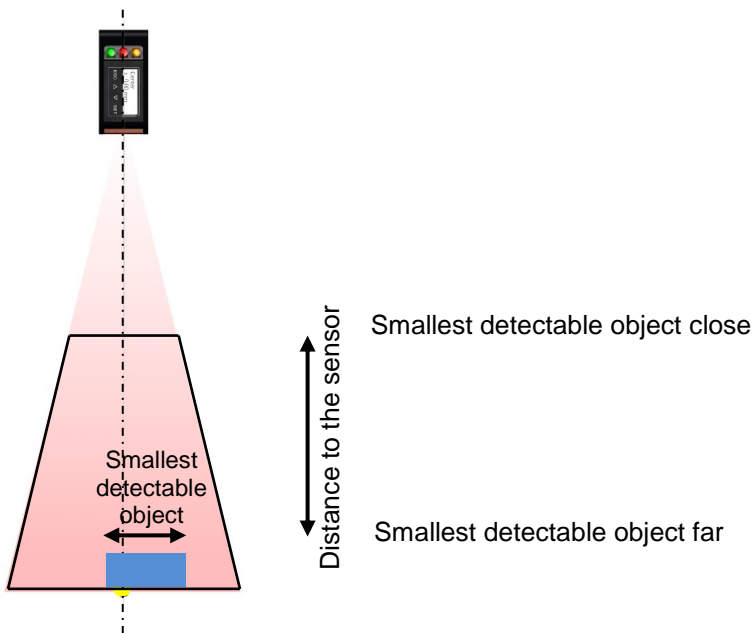

6.5.2 Reflectivity

Bright objects are generally easier to detect than dark objects, since they are more reflective. Reflectivity is the percentage relationship between incident and reflected light.

Definition of objects:

White object	Approx. 90% reflectivity
Black object	Approx. 6% reflectivity
Bright object	> 18% reflectivity
Dark object	6...18% reflectivity

6.5.3 Standard object

The technical data for sensors in the data sheet refers to measurements with a Baumer standard object. This standard object is precisely defined in size, shape and color, making multiple measurements comparable.

Standard object definition:

- White ceramic (reflectivity approx. 90%)
- Smooth, flat surface

¹ According to data sheet chapter 6.1

- Covers entire sensor measuring range

6.6 Interfaces and outputs

All sensor inputs and outputs that transmit measuring data are referred to as interfaces.

- Analog current output
- Synchronization
- Switching output
- Alarm output
- RS-485

NOTE



When an object moves laterally out of the measuring field, the last valid output value is retained until an object is again present in the measuring range.

6.6.1 Analog signal output

Current or voltage output

The sensor has an analog output that can send a current or voltage signal through the same pin. The desired CURRENT or VOLTAGE output function can be activated in the SYSTEM --> ANALOG sensor settings or with an RS485 command.

Analog output with HEIGHT function

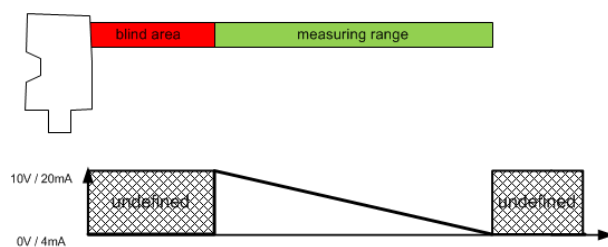

NOTE



If the object leaves the measuring range, the analog output will hold the last valid condition.

6.6.1.1 Formulas for analog signal conversion

The measuring values can be converted from mm into the analog output signal and vice versa with the following formulas.

If the measuring range has been limited with SCALE OUT, the new settings for **Current Start of measuring range Sdc** and **Current End of measuring range Sde** must be used.

HEIGHT function definitions

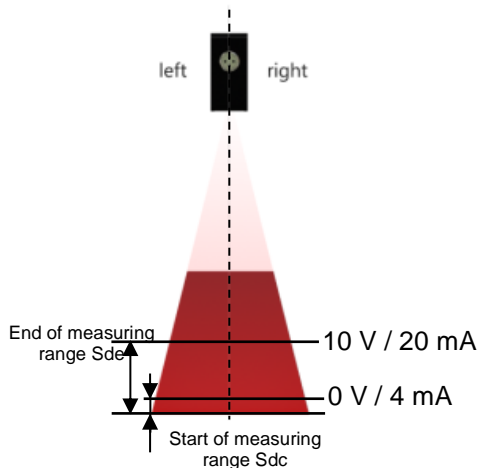

$$\text{Measuring value in V} = \frac{\text{Measuring value in mm} - S_{dc}}{S_{de} - S_{dc}} * 10V$$

$$\text{Measuring value in mA} = \frac{16 \text{ mA} * (\text{Measuring value in mm} - S_{dc})}{S_{de} - S_{dc}} + 4 \text{ mA}$$

$$\text{Measuring value in mm} = \frac{\text{Measuring value in mA} * (S_{de} - S_{dc}) + (20 \text{ mA} * S_{dc}) - (4 \text{ mA} * S_{de})}{16 \text{ mA}}$$

$$\text{Measuring value in mm} = \frac{\text{Measuring value in V} * (S_{de} - S_{dc}) + (10 \text{ V} * S_{dc})}{10 \text{ V}}$$

HINWEIS



S_{dc} and S_{de} are always in mm.

6.6.2 Sync-In / Trigger

The measurement and signal output can be interrupted with the Sync-In input by connecting with high. As long as Sync-In stands at high, the sensor delays the next measurement (Hold) and reduces the power of the laser beam.

- The sensor checks the Sync-in before each measurement
- The previous measurement cycle will be always completed, even if the sync-in is High
- The sensor reduces the power of the laser beam during the waiting period (Hold)
- The outputs are held in the last valid state during Hold
- To come back to measuring mode, the Sync-In has to be set from High to Low
- The Sync-in must be at least 5µs at Low to come back to the measuring mode

Sync-In	Level	Measurement
Sync-In low	0...2.5 V	Run
Sync-In high	8 V...UB (operating voltage)	Hold

Example: Mutual interference

Only the laser beam of Sensor1 may be in the measuring field of Sensor1. The laser beam of Sensor2 must be outside the measuring field from Sensor1.

If it is not possible to prevent several sensors from affecting each other through appropriate installation, the sensors affecting each other can be operated asynchronously by the Sync-In cable. The superordinate control generates the signals for this.

HINT



Once the Sync-In is set to High (Hold), all output functions are frozen in their last state until the next measurement.

Measuring if Sync-In low

The sensor checks the level of the Sync-In each time before it sends out the laser pulse. If it is low, the sensor will immediately begin the next measurement.

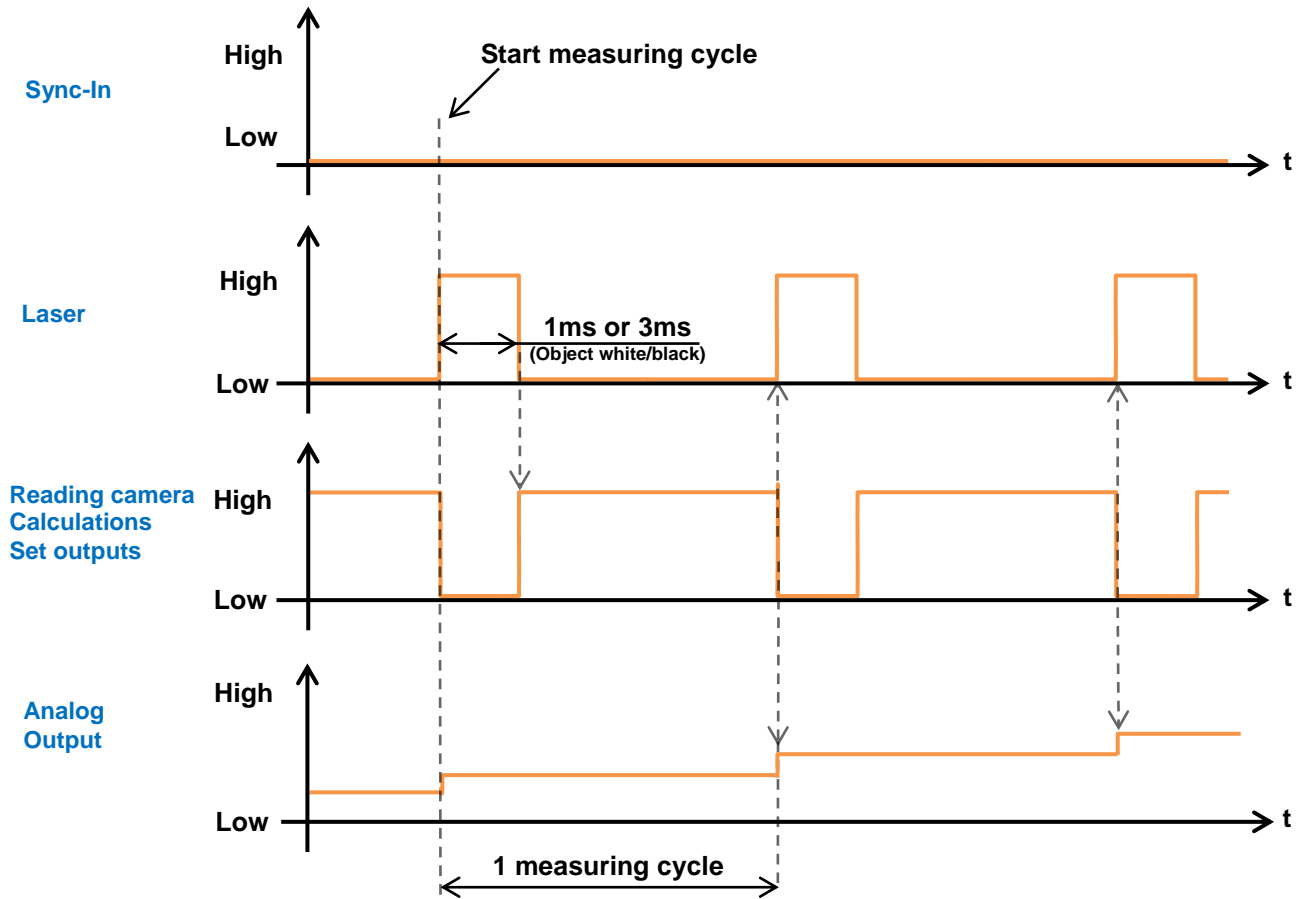

Sync-In Low to High:

If the Sync-In level is High, the sensor completes the actual measurement, but do not start the next measurement. All outputs are held (Hold function).

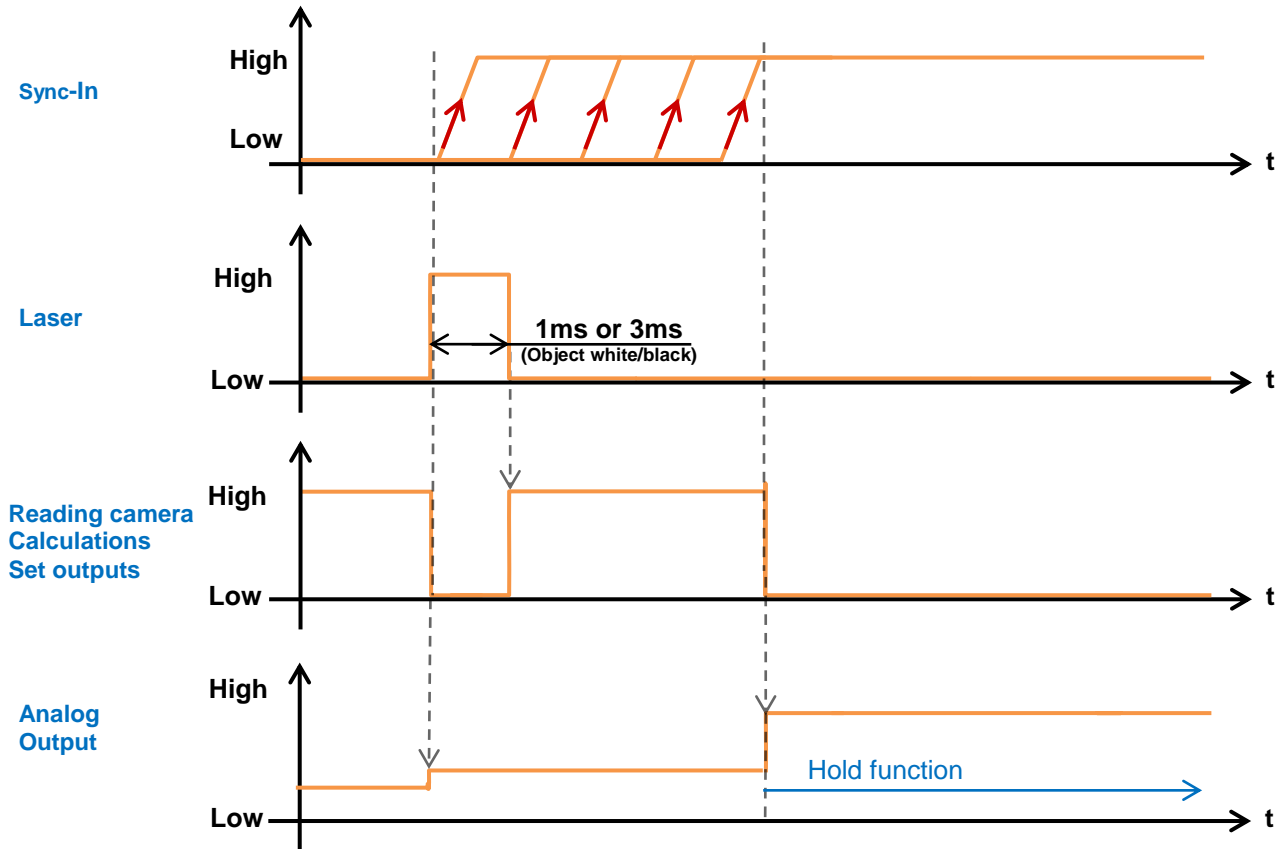

Sync-In High to Low:

Sync-In has to set from High to Low to bring the sensor back into the measuring mode. The Sync-In must be at least $5\mu\text{s}$ set to low level, so that the sensor starts to measure. For this first measuring cycle, the response time will be $5\mu\text{s}$ longer.

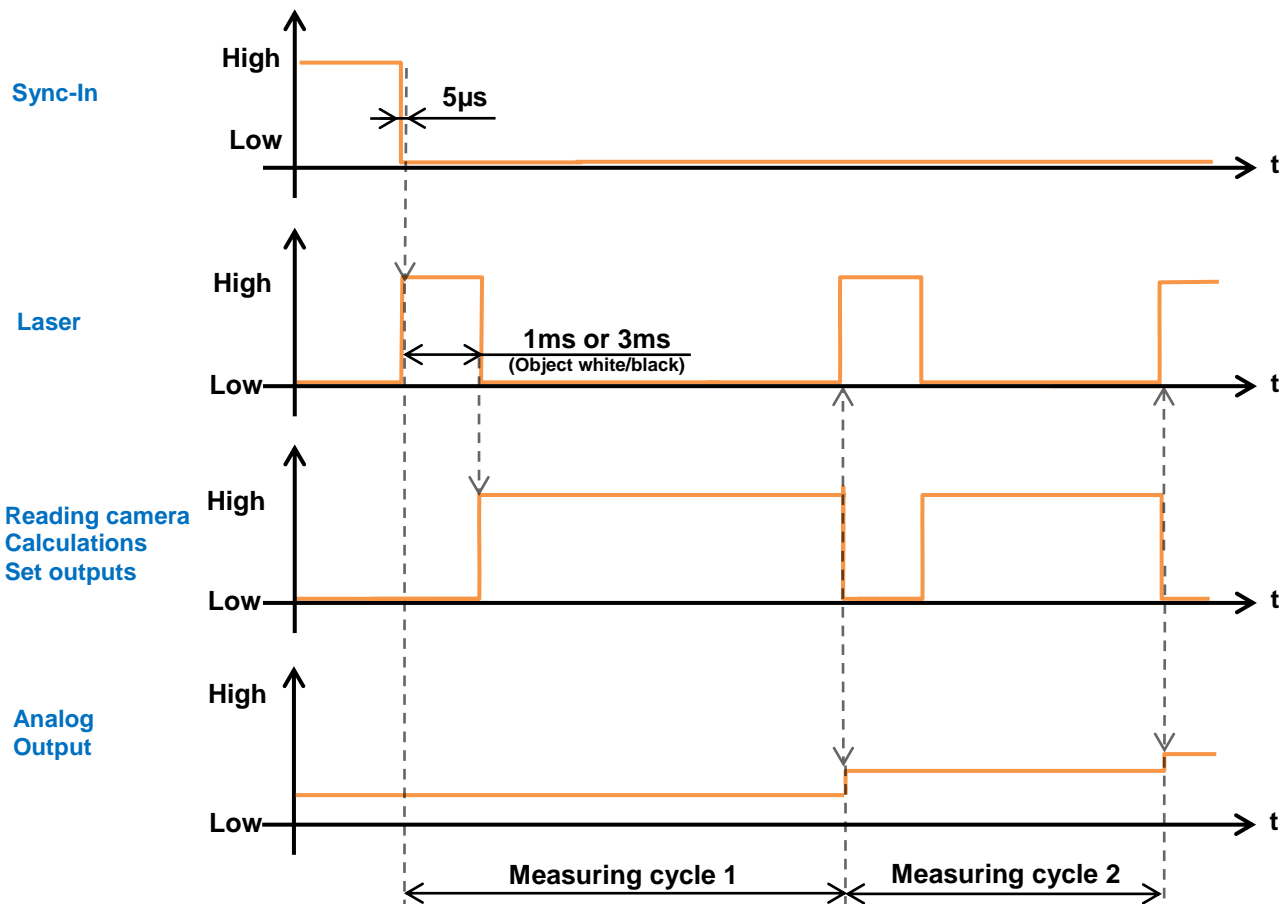

6.6.3 Switching output

The switching output can be set as a point or a window, see Section DIGITAL OUT.

The output is transmitted as a push-pool signal with active high or active low (inverted), depending on the setting.

6.6.4 Alarm output

The sensor evaluates the signal level (amount of reflected light) during every measurement cycle. If this level falls below a defined value (signal gain), the alarm output and red LED on the sensor are activated.

Reasons for a low signal level:

- Signal gain too small
- Incorrect mounting angle
- Insufficient light reflected from the object
- Object outside the measuring field

Signal level	Red LED	Alarm output out2	RS485 quality bit
Signal gain reached	Off	Low	Valid
Signal gain not reached	Blinks (8 Hz)	Low	Low signal
No object inside the measuring range	On	High	No signal

The alarm output cannot be adjusted and is triggered by the following situations:

- No object in the measuring field
- Insufficient signal gain (e.g. with soiling) or or incorrect OBJECT setting.

The alarm signal is output as a push-pull signal (active high).



NOTE

There is no excess gain hysteresis, which is why rapid switching between alarms can occur.

6.6.5 Interface RS-485

No more than 32 sensors may be connected to one bus during operation with RS-485.

When the RS-485 interface is activated, the analog output, digital output and alarm output are deactivated or switched as if there was no object in the measuring range.

See separate RS-485 manual for further information.

6.6.6 Response of outputs

If no object is within the measuring range, the sensor will hold the last valid signal. The alarm output is high during this time.

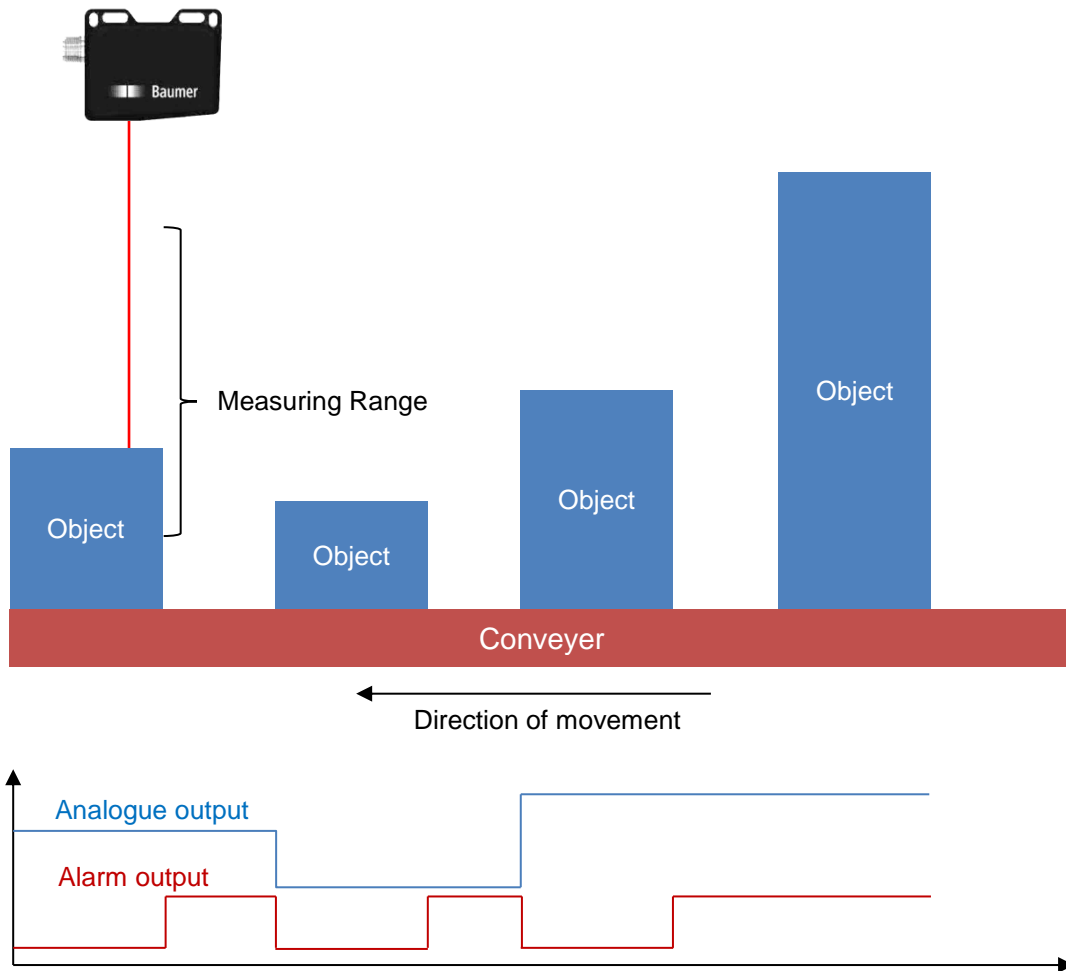

6.7 Touch panel

6.7.1 Function and design

The display consists of a monochrome 128 x 32 pixel LCD with RGB LED background illumination. The sensor can be configured using four capacitive touch operator interfaces.

6.7.2 Dimensioning

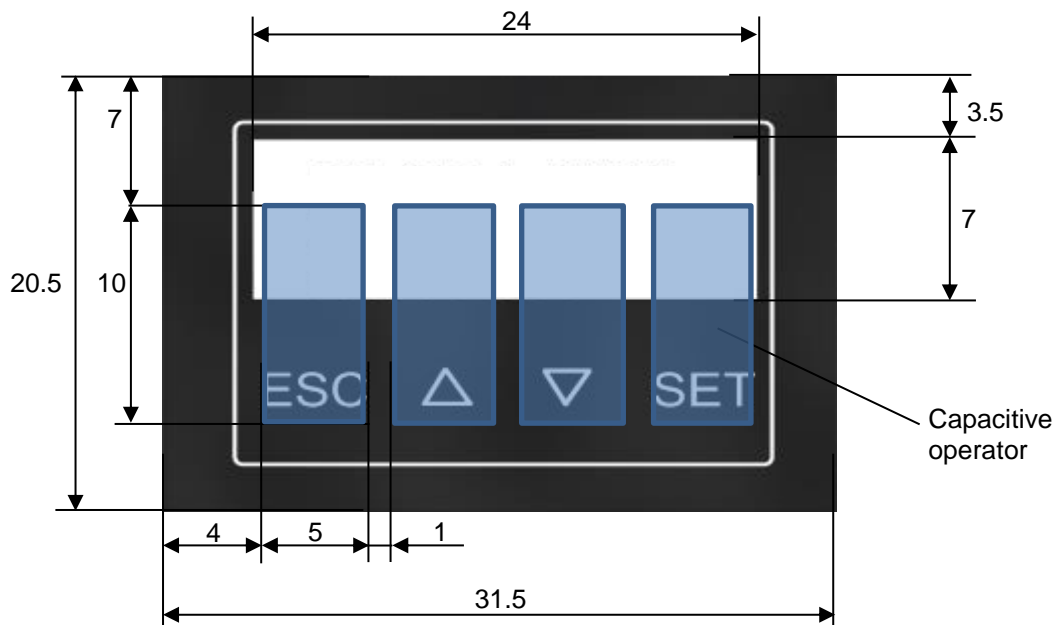

6.8 Memory

All changes made in the sensor are saved in nonvolatile (permanent) memory and are even retained after a power outage.

6.9 Standard deviation

The standard deviation is a term from the field of statistics or stochastics and is given in σ (sigma). With the standard deviation it is possible to determine how great the dispersion of values around a mean value is. Broadly speaking, the standard deviation is the average distance of all measured expressions of a characteristic from the mean value.

The standard deviation is only useful if you consider measured values which should actually be identical but which vary. For the sensor, this means that an even surface is observed vertically (or with an activated FLEX MOUNT). The standard deviation is then a measure for the unevenness of the surface. All measuring points within the preset field of view are taken into consideration.

Remember

- The standard deviation is a measure for the dispersion of the height values of all measured profile points in mm.
- It can only be used on a plane that is either vertical with respect to the sensor or is parallel to the Flex Mount reference.
- The plane must cover the entire field of view in the X direction.

6.9.1 Example

This is a profile of 190 points on an even surface as recorded by the sensor before evaluation (height in mm). It is a typical line.

The red line represents the mean value, and the green lines each represent 1x standard deviation. The standard deviation indicates how level the measured line is.

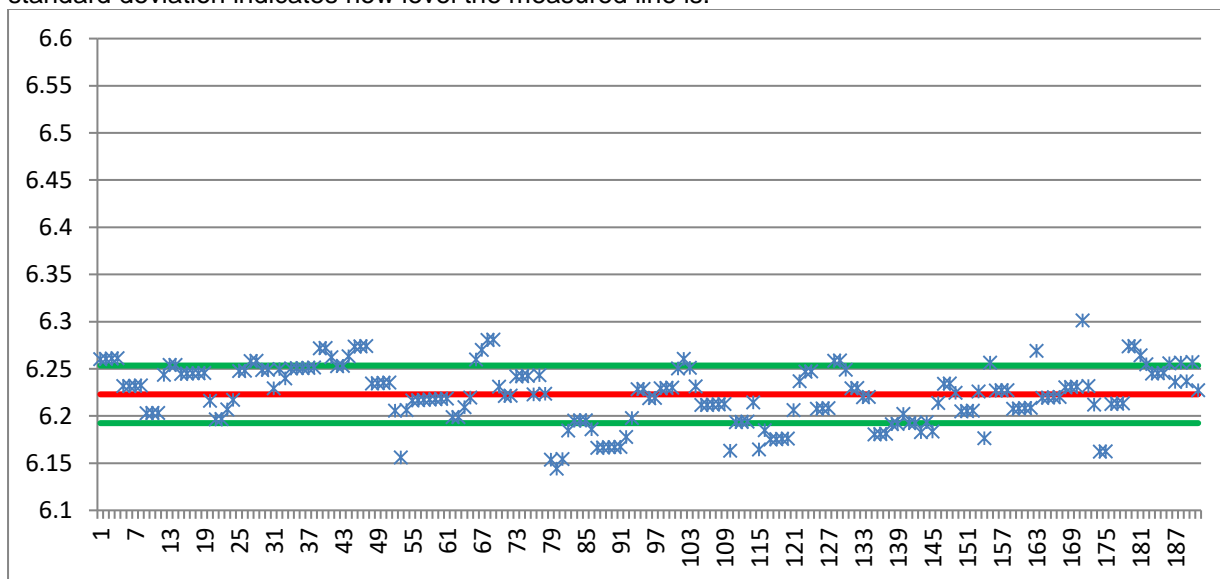

Standard deviation: 0.03 mm

Max-Min = 0.157mm

7 Safety instructions and maintenance

7.1 General safety instructions

Intended use

This product is a precision device and is used for object detection and the preparation and/or provision of measuring values as electrical quantities for a subsequent system. Unless this product is specially labeled, it may not be used for operation in potentially explosive environments.

Commissioning

Installation, mounting and adjustment of this product may be performed only by a qualified person.

Installation



For mounting, use only the mechanical mountings and mechanical mounting accessories intended for this product. Unused outputs must not be wired. In cable versions with unused cores, these cores must be insulated. Always comply with admissible cable bending radii. Prior to electrical connection of the product, the system must be disconnected from the power supply. In areas where shielded cables are mandatory, they must be used as protection against electromagnetic disturbances. If the customer makes plug connections to shielded cables, an EMC version of the connectors should be used, and the shield must be connected to the connector housing across a large area.

CAUTION

Use of controls or adjustments or performance of procedures other than those specified herein may result in hazardous light exposure.

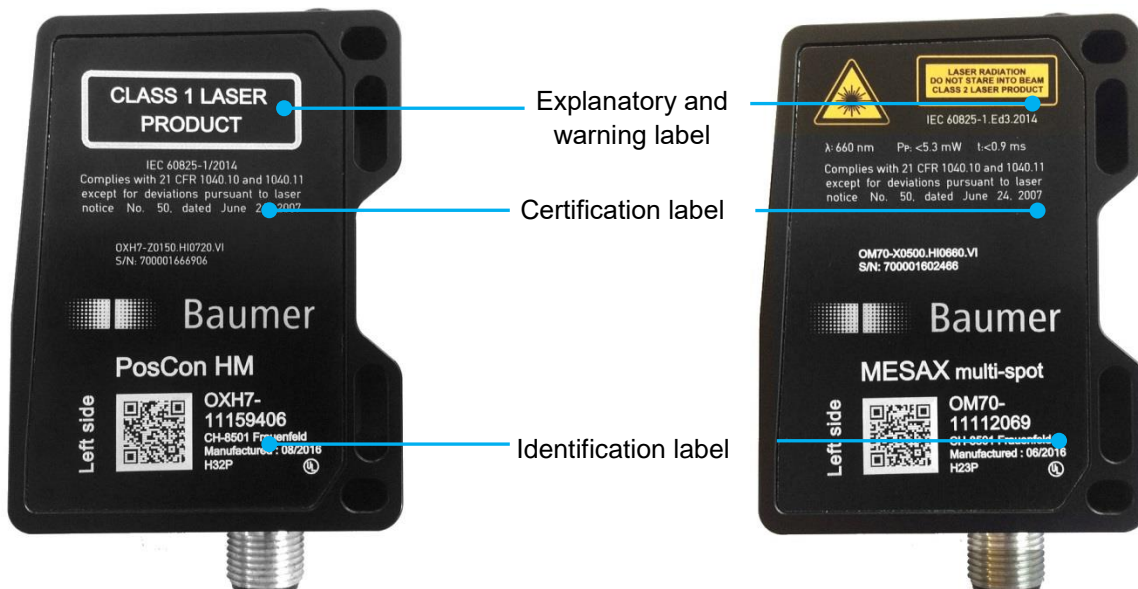
7.2 Part Identification



Explanatory and warning label	<p style="text-align: center;">Class 1: No risk to eyes or skin</p> <div style="border: 2px solid black; padding: 10px; text-align: center;"> <p>CLASS 1 LASER PRODUCT</p> </div> <p>A Class 1 laser product is defined as safe in normal operations under reasonably foreseeable conditions, including long-term direct viewing of the beam, even when exposure occurs while using telescopic optics. However, direct viewing of a Class 1 laser product may still produce dazzling visual effects, particularly in low ambient light.</p>	<p style="text-align: center;">Class 2: Do not stare into beam</p> <div style="border: 2px solid black; padding: 10px;">  <p style="text-align: center;"> LASER RADIATION DO NOT STARE INTO BEAM Wavelength: 640...670nm IEC 60825-1, Ed. 3, 2014 CLASS 2 LASER PRODUCT </p> </div> <p>Class 2 lasers emit radiation in the visible portion of the spectrum (400 nm to 700 nm). A short-term exposure (duration to 0.25 s) is harmless to the eye. Random short-term impacts (to 0.25 s) do not damage the eye, because the blink reflex can automatically adequately protect the eye against longer irradiation. Class 2 lasers may be used without any additional protection, if it is ensured that for an application no intentional look longer than 0.25 s is required, or (for example, by drug exposure) the blink reflex is suppressed.</p>
Certification label	<p style="text-align: center;">FDA certification label</p> <p style="text-align: center;">Complies with 21 CFR 1040.10 and 1040.11 except for conformance with IEC 60825-1 Ed. 3., as described in Laser Notice No. 56, dated May 8, 2019</p>	
Identification label	<div style="text-align: center;">  </div> <p>The sensor identification part contains the following information:</p> <ul style="list-style-type: none"> • Company Logo • Sensor brand name • QR-Code to find more info • Article description and article number • Production information • Serial number 	

7.3 Influence of ambient light

Ambient light from lamps, the sun, etc. in the view field of the sensor can lead to malfunctions or a reduction of accuracy and should be avoided as much as possible.

7.4 Front (optics)

In the event of broken front window, broken display panel or loose or detached laser optics the sensor must immediately be disconnected from the power supply and it must not be put back into operation until it has been repaired by an authorized person.

Non-compliance with these safety instructions may result in hazardous radiation exposure!

**ATTENTION!**

The use of a sensor with a broken front glass or dissolved or detached lens may result in hazardous radiation exposure.

7.5 Cleaning the sensors

The laser distance sensors do not require any maintenance, except that the front windows must be kept clean. Dust and fingerprints can impair sensor function. It is normally sufficient to wipe the windows with a clean (!), soft lens cleaning cloth. Alcohol or soapy water can be used in case of severe soiling.

The display and the keys must be kept free from dirt and moisture. Water and dirt on the keys can impair their function.

7.6 Disposal

This sensor contains electronic components. Components are to be disposed of according to the regulations prevailing in the respective country.

8 Error correction and tips

8.1 Examples of sensor setup

8.1.1 Analog height measurement with inclined installation of 30°, height 10 mm = 0V, height 30 mm = 10 V

1. Connection: In accordance with connection diagram
2. Installation: The sensor is installed at an inclination of 30°. The object must be inside the measuring range during the measuring process.
3. Select Max HEIGHT measurement type for maximum object height output.
4. Teach in the reference surface with FLEX MOUNT
5. Limit the analog output using SCALE OUT. OFFSET = 10 mm; HEIGHT = 30 mm

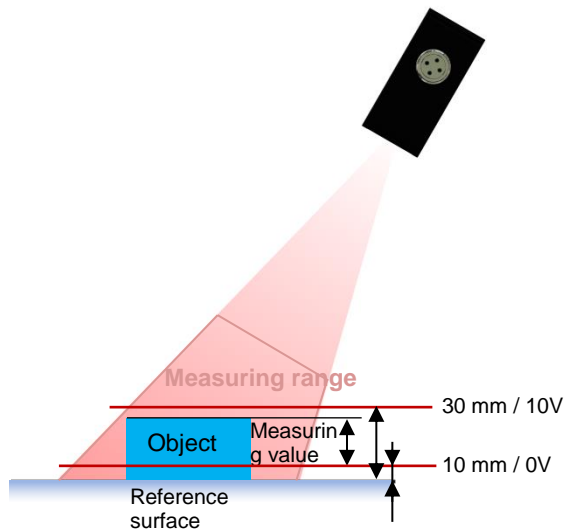

8.1.2 Delta height measurement (max-min), with limited measuring field left 5mm and right 20mm, with inclined installation of 30°.

1. Connection: In accordance with connection diagram
2. Installation: The sensor is installed at an inclination of 30°. The object must be inside the measuring range during the measuring process.
3. Select Delta HEIGHT measurement type for output of max-min difference.
4. Teach in the reference surface with FLEX MOUNT
5. With FIELD OF VIEW, the measuring field is limited using LIMIT LEFT = 5 mm and LIMIT RIGHT = 20 mm

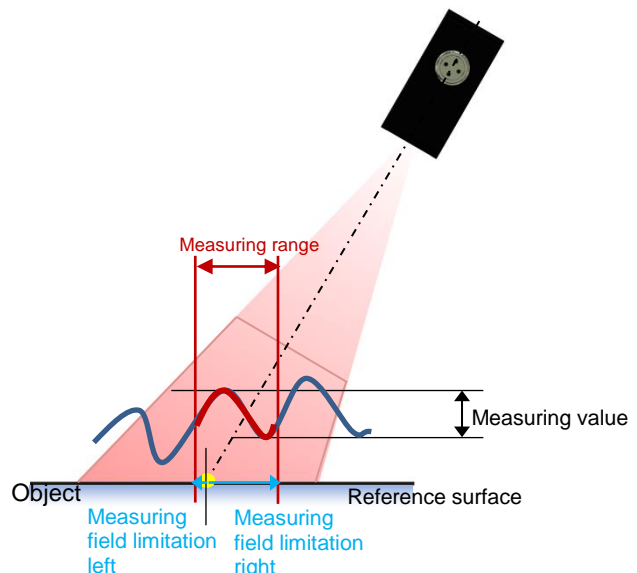

8.2 Error correction

Error	Error correction
No function	<ul style="list-style-type: none"> • Check connection. Power supply 15...28 VDC between pin 2 (+Vs, brown) and pin 7 (GND, blue)
Green LED flashes	<ul style="list-style-type: none"> • Short circuit at the digital output. Check connection.
Red LED lights up	<ul style="list-style-type: none"> • Object outside measuring field (near, far or to the side) • Amplitude of the received signal is insufficient (e.g. in case of soiling)
Touch panel cannot be operated	<ul style="list-style-type: none"> • Touch panel locked. Re-enable panel for operation by sliding a finger over the 4 keys from left to right. • RS-485 controls the sensor--> operation via the touch panel not possible at the same time • RS-485 locks the touch keys--> the touch panel was locked via RS-485 and can only be re-enabled with a command via RS-485
Touch panel does not react	<ul style="list-style-type: none"> • Clean panel. The panel is dirty or wet, which makes it harder to press the keys
Sensor does not provide the expected measuring results	<ul style="list-style-type: none"> • Check inclination angle and work with the FLEX MOUNT mode if required (teach in the new reference surface) • The object is not in the measuring range • Bright object, avoid direct reflexes from the transmitter to the receiver
The sensor does not capture all objects within the measuring field	<ul style="list-style-type: none"> • Enlarge measuring field. The measuring field was possibly limited; see " FIELD OF VIEW " Section • The red visible laser beam does not represent the maximum measuring field If the object is at the edge of this beam it could be outside the measuring range • Move object. The object is outside the measuring field vertically or is in the blind region of the sensor
Unreliable measuring value: The measuring value jumps back and forth	<ul style="list-style-type: none"> • The object is not in the measuring range • Avoid bright object • Avoid very dark object • Too much ambient light • Check measuring mode setting (MEAS TYPE)
Transmitting laser light is dim	Sync-In input is on High--> set to Low

9 Revision history

23.11.2015	tof	Manual released in version 1.0
26.01.2016	tof	Integrated linearity and definition of response time and measuring repetition time
8.04.2016	tof	Integrated new article; optimized Laser characteristics
28.04.2016	tof	Additional information about the working principle of the filter PREZISION
31.05.2016	tof	New sensor type integrated. Chapter 6.1 updated
15.06.2016	tof	Chapter "beam divergence" updated
19.09.2016	tof	V.1.2: FLEX MOUNT: "Correction" instead of "Ref thickness". Description of this new feature. 2 decimal places instead of 1. New chapter hysteresis.
17.01.2017	tof	Measuring values repeat accuracy for 100...150mm types implemented
19.05.2017	tof	Measuring range distance error in chapter 6.1 corrected
9.10.2017	tof	Minimum window size for digital output changed
2.3.2018	tof	Precision filter values corrected.



Passion for Sensors

Baumer Group
International Sales
P.O. Box · Hummelstrasse 17 · CH-8501 Frauenfeld
Phone +41 (0)52 728 1122 · Fax +41 (0)52 728 1144
sales@baumer.com · www.baumer.com