

Operating instructions.

OM70 multi-spot.



Contents

1	General information.....	3
1.1	Concerning the contents of this document	3
1.2	Intended use	3
1.3	Safety instructions	4
2	Mounting and connections	5
2.1	Dimensions	5
2.2	Sensor reference levels	6
2.3	Definition of the field of view	7
2.4	Mounting	11
2.5	Connection and commissioning.....	14
3	Configuration via the web interface.....	19
3.1	The web interface	19
3.2	Monitoring	21
3.3	Parametrization.....	24
3.4	Device Configuration	41
4	Communication via the process interfaces	43
4.1	Introduction	43
4.2	Modbus TCP	44
4.3	OPC UA	62
5	Operation	76
5.1	Status displays on the sensor.....	76
5.2	Measuring frequency, measuring repeat time, and response time.....	77
5.3	Alarm output.....	77
5.4	Object to be measured	78
5.5	Memory.....	79
5.6	Error correction and tips	80
6	Safety instructions and maintenance.....	81
6.1	General safety instructions	81
6.2	Sensor inscriptions	82
6.3	Front optic.....	83
6.4	Cleaning the sensors	83
6.5	Disposal	83
7	Sensor data sheet.....	84
8	Revision history	87

1 General information

1.1 Concerning the contents of this document

This manual contains information about the installation and initial setup of Baumer OM70-X multi-spot sensors.

It is a supplement to the mounting instructions supplied with each sensor.



Read these operating instructions carefully and follow the safety instructions!

1.2 Intended use

The Baumer OM70-X multi-spot sensor measures distances to objects. It was especially developed for easy handling, flexible use, and precise measurement.

1.2.1 Functional principle of triangulation



The sensor works on the laser triangulation principle. By means of special optics, a laser beam is enlarged into a line and projected to the surface of the object to be measured. Using the multi-lens system, the reflected light from this laser line is projected onto a matrix. From this matrix image, a controller calculates the distance to every individual measuring point. The measuring value is calculated in accordance with the selected function. Thanks to the new Baumer technology, the object height is always output correctly, independent of the object's position in the measuring field.

1.3 Safety instructions

**NOTE**

Provides helpful operation instructions or other general recommendations.

**ATTENTION!**

Indicates a potentially hazardous situation. Avoid these situations in order to prevent any personal injury or damage to the device.

2 Mounting and connections



ATTENTION!

Connection, installation, and commissioning may only be performed by qualified personnel. Protect optical surfaces from moisture and dirt.

2.1 Dimensions

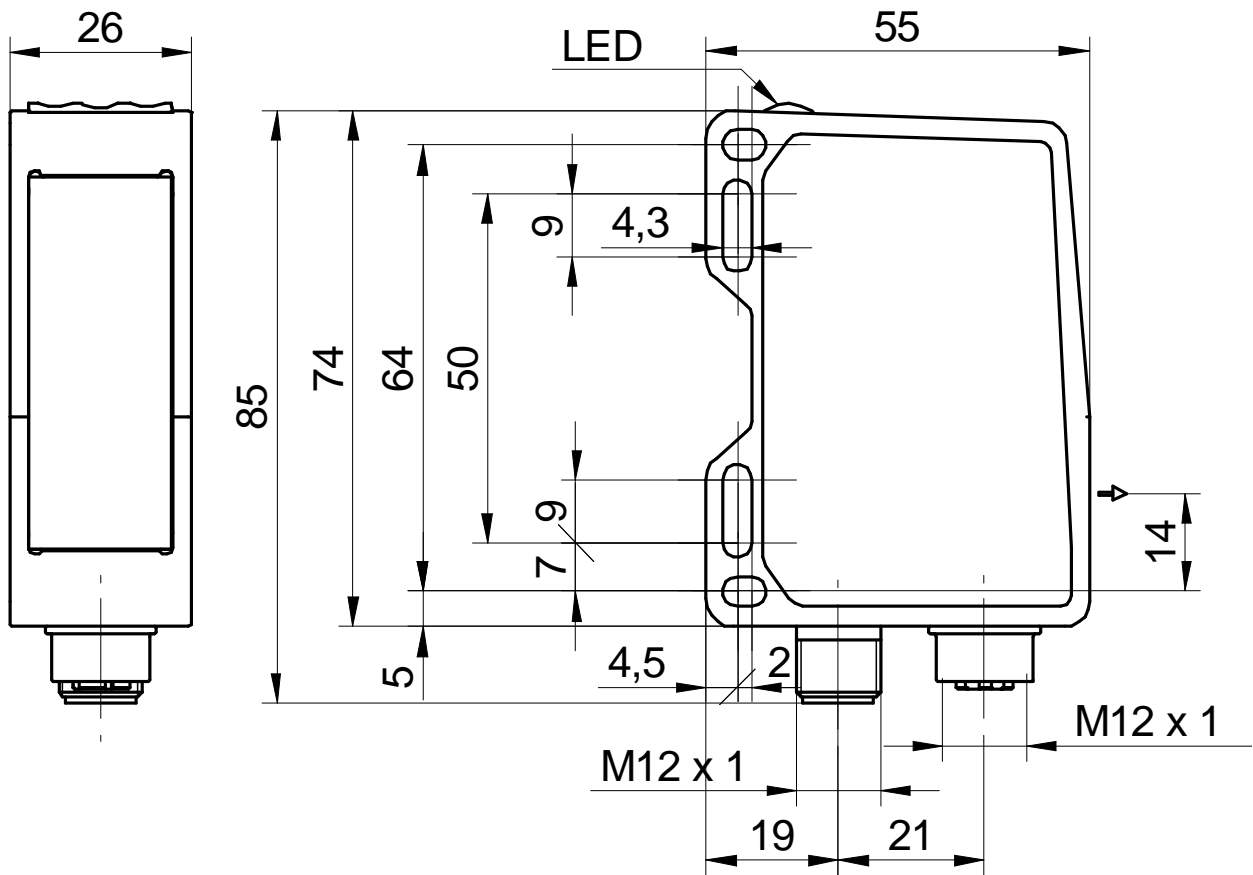

*Optical axis

2.2 Sensor reference levels

To ensure that the sensor is easy to align during installation, reference levels have been defined. The laser beam of the sensor runs parallel (//) to level R3 and is at a right angle to levels R1 and R2. Levels R1, R2, and R3 serve as a reference for sensor alignment during installation. The "Left" and "Right" alignment must also be observed.

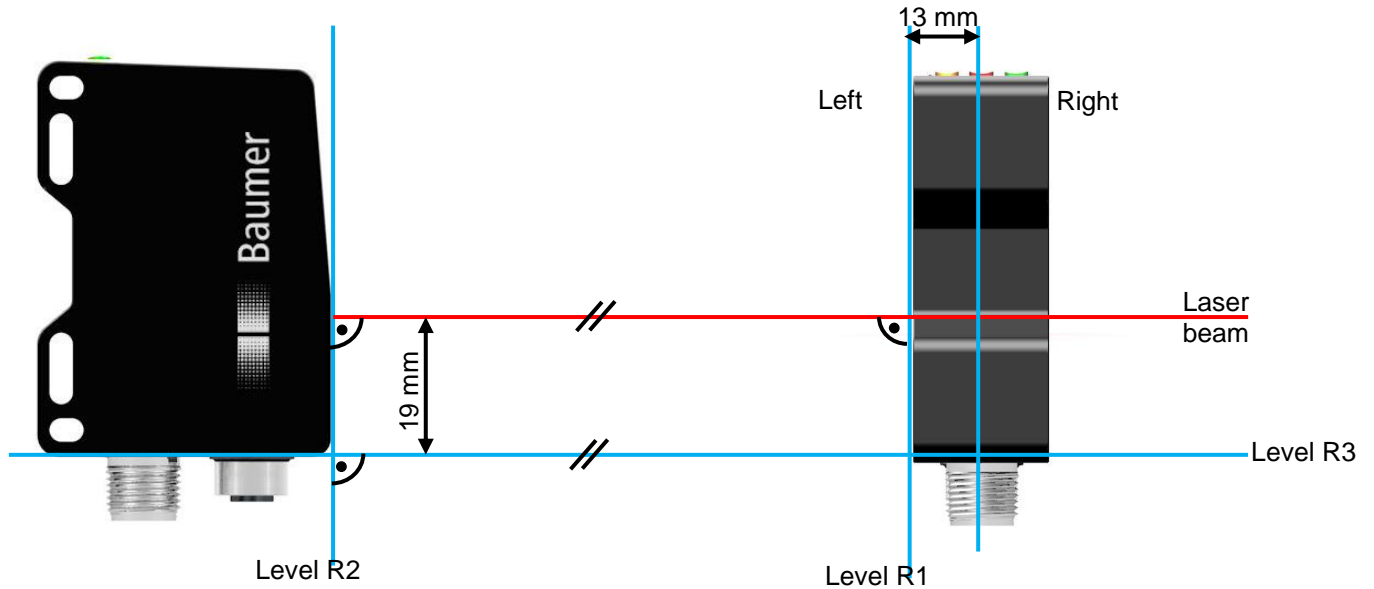

2.3 Definition of the field of view

The maximum field of view and additional important field of view definitions are described in the following diagram. The important terms "left" and "right" are to be regarded respectively from the viewpoint of the connector side of the sensor.

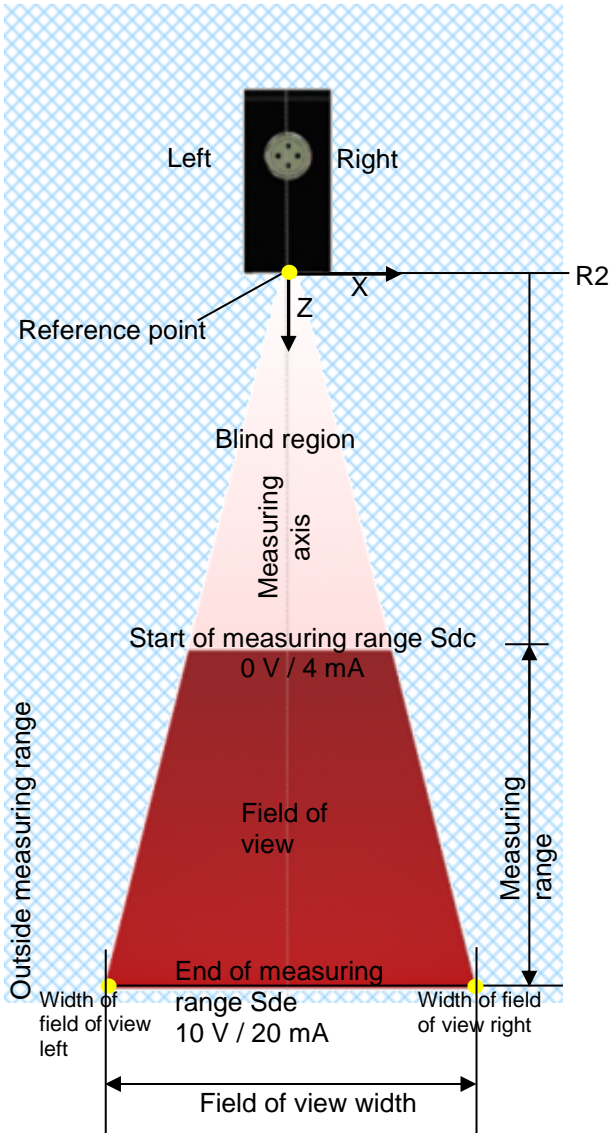

The sensor measures distances within the field of view. The sensor level R2 applies as a reference for 0.

2.3.1 Blind region

The region from the sensor level R2 up to the start of measuring range Sdc is called the blind region, i.e., the sensor cannot detect any objects there.

If there are any objects in this region, this can lead to incorrect measured values.

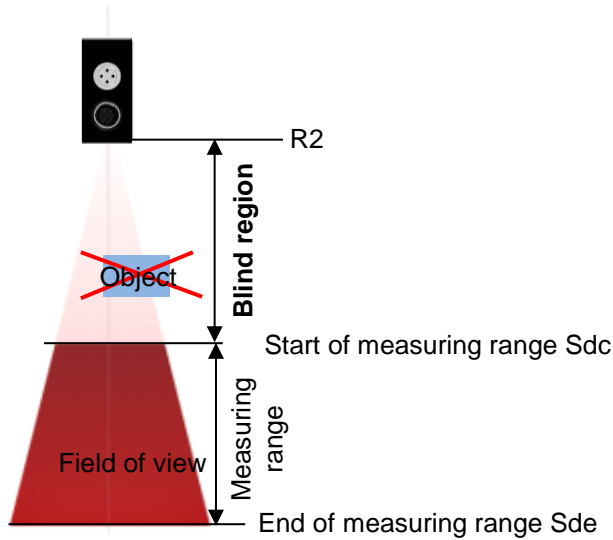

2.3.2 Transmitter and receiver axis

The transmitter and receiver axes must not be covered by obstacles, since this could adversely affect precise measurements.

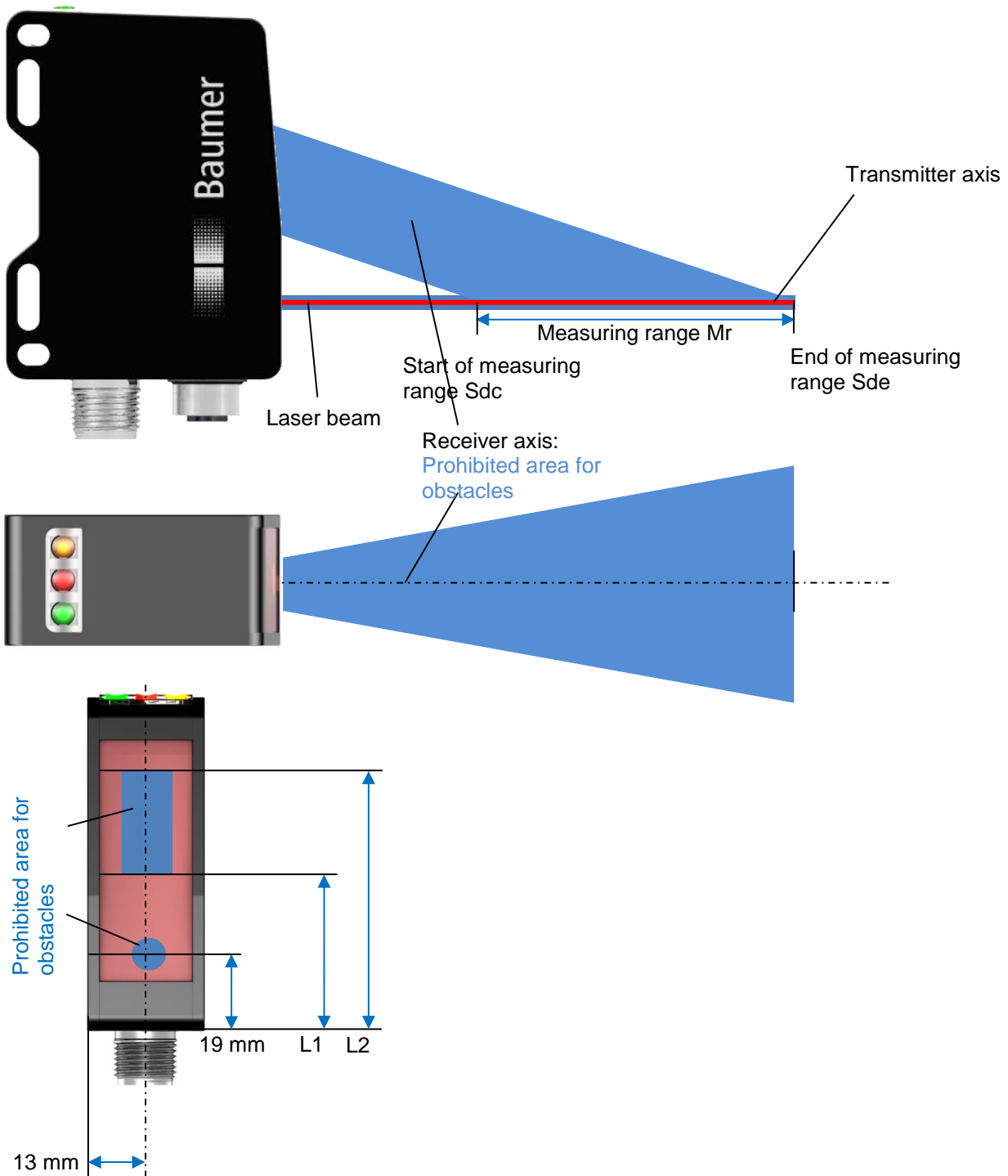

2.3.3 Precise laser alignment with qTarget

The field of view is aligned with the housing reference surfaces at the factory. The beam position in every sensor is in exactly the same spot, which makes planning and sensor replacement very easy.

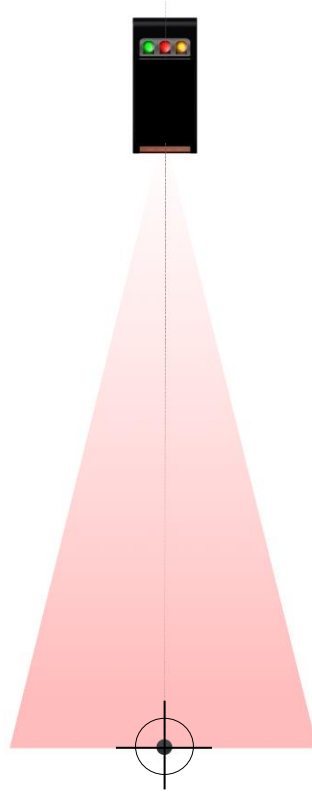

2.4 Mounting

The sensor has four mounting holes for flexible alignment and mounting. The use of 2 M4x35 screws is recommended for mounting. The tightening torque is max. 1.2 Nm.



2.4.1 Installation accessories

To ensure optimal mounting, various mounting brackets are available as an accessory. These brackets fit the mounting holes of the sensor exactly. The sensor can be shifted and adjusted inside the mounting hole.

2.4.1.1 Mounting kit for standard installation Order no. 11120705

With the mounting bracket for standard installation, the sensor can be mounted quickly and easily at a 90° angle to the reference surface.

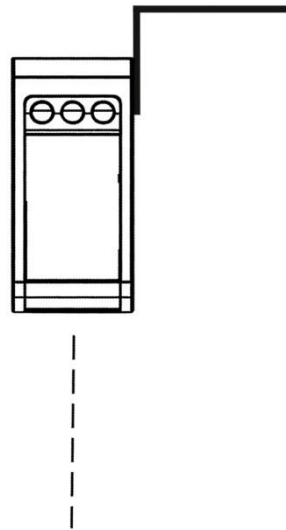

Mounting kit 11120705

Contents of this set:

- 90° mounting bracket
- Threaded plate
- 2x spherical head screw M4x35 Torx
- 1x Torx tool T20

2.4.1.2 Mounting kit for $\pm 30^\circ$ angled installation with horizontal mounting Order no. 11126836

If it is not possible to position the sensor at right angles to the reference surface, the sensor can be mounted at an inclination angle of $\pm 30^\circ$ with this mounting kit.

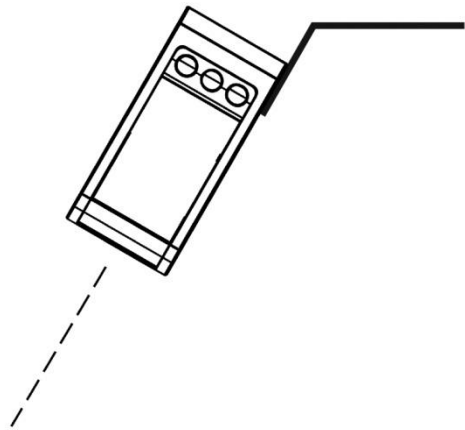

Mounting kit 11126836

Contents of this set:

- 30° mounting bracket, horizontal
- Threaded plate
- 2x spherical head screw M4x35 Torx
- 1x Torx tool T20

2.4.1.3 Mounting kit for $\pm 30^\circ$ angled installation with horizontal mounting Order no. 11126837

If it is not possible to position the sensor at right angles to the reference surface, the sensor can be mounted at an inclination angle of $\pm 30^\circ$ with this mounting kit.

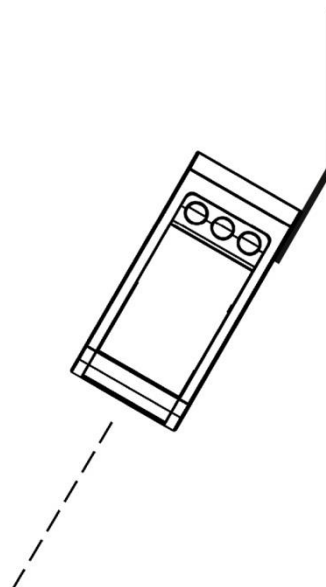

Mounting kit 11126837

Contents of this set:

- 30° mounting bracket, vertical
- Threaded plate
- 2x spherical head screw M4x35 Torx
- 1x Torx tool T20

2.5 Connection and commissioning

**ATTENTION!**

Only carry out wiring work when the device is de-energized.
Incorrect supply voltage will destroy the device!

**ATTENTION!**

Connection, installation, and commissioning may only be performed by qualified personnel.

**ATTENTION!**

The IP protection class is valid only if all connections are connected as described in the technical documentation.

**ATTENTION!**

Laser class 1 laser beam according to EN 60825-1:2007. This product can be operated safely without any additional safety precautions. Nevertheless, direct contact between the eye and beam should be avoided.

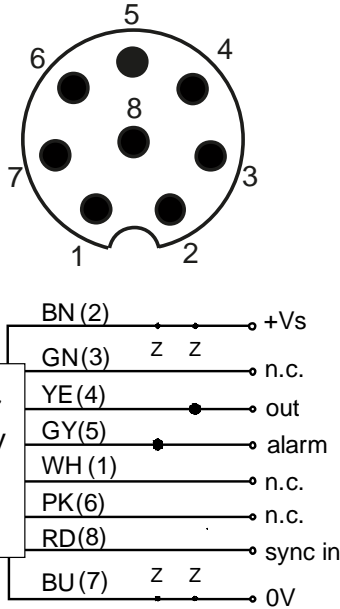
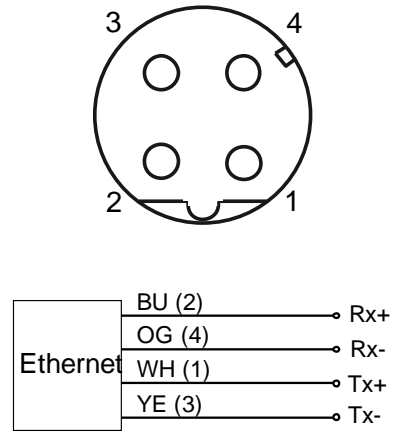
2.5.1 Pin assignments and connection diagrams
M12 8-pin

M12 4-pin

	Color	Function	Description
Pin 1	WH = white	n.c.	Not used
Pin 2	BN = brown	+Vs	Voltage supply (+15...+28 VDC)
Pin 3	GN = green	n.c.	Not used
Pin 4	YE = yellow	out	Switching output, push-pull
Pin 5	GY = gray	alarm	Alarm output, push-pull
Pin 6	PK = pink	n.c.	Not used
Pin 7	BU = blue	0V	Ground GND
Pin 8	RD = red	sync in	Synchronization input

	Color	Function	Description
Pin 1	WH = white	Tx+	TX+ (BI_DA+)
Pin 2	BU = blue	Rx+	RX+ (BI_DB+)
Pin 3	YE = yellow	Tx-	TX- (BI_DA-)
Pin 4	OG = orange	Rx-	RX- (BI_DB-)

M12 8-pin
M12 4-pin

NOTE

We recommend that you connect unused cables to GND (0V).

2.5.2 Connection cables as accessories

2.5.2.1 M12 8-pin

An 8-pin, shielded connection cable (connector) is required to supply the digital inputs/outputs with power.

Baumer connection cables with the following order codes are recommended:

- 10127844 ESG 34FH0200G (M12 8-pin; length 2 m, straight plug)
- 11053961 ESW 33FH0200G (M12 8-pin; length 2 m, angled plug)
- 10129333 ESG 34FH1000G (M12 8-pin; length 10 m, straight plug)
- 10170054 ESW 33FH1000G (M12 8-pin; length 10 m, angled plug)

Other cable lengths are available.

2.5.2.2 M12 4-pin

A 4-pin, shielded cable is used to transmit the Ethernet signals.

Baumer connection cables with the following order codes are recommended:

- 11048502 KSG 34A/KSG45AP0200G/E (M12 4-pin to RJ45, length 2 m, straight plug)
- 10165276 KSG 34A/KSG45AP0500G/E (M12 4-pin to RJ45, length 5 m, straight plug)
- 11051929 KSG 34A/KSG45AP1000G/E (M12 4-pin to RJ45, length 10 m, straight plug)

Other cable lengths are available.

	Color	Function
Pin 1	WH = white	Tx+
Pin 2	BU = blue	Rx+
Pin 3	YE = yellow	Tx-
Pin 4	OG = orange	Rx-

	Color	Function
Pin 1	white/orange	TX+ (BI_DA+)
Pin 2	orange	TX- (BI_DA-)
Pin 3	white/green	RX+ (BI_DB+)
Pin 4	blue	n.c.
Pin 5	white/blue	n.c.
Pin 6	green	RX- (BI_DB-)
Pin 7	white/brown	n.c.
Pin 8	brown	n.c.

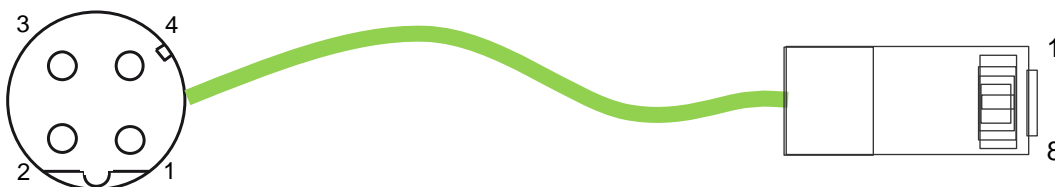

2.5.3 Initial setup of the Ethernet interface on the computer

2.5.3.1 Assigning an IP address

To use the device in your network, you must assign a unique IP address to the device.

1. If you have a DHCP server integrated into your network, the IP address is requested from this server. No additional manual actions are necessary on your part.
2. If a valid IP address cannot be obtained within 15 seconds, the static IP address is used. When the device is delivered, this is IP address 192.168.0.250 (subnet mask: 255.255.255.0).



NOTE

To avoid network malfunctions, ensure that each IP address is unique within the network and has not already been assigned.

Now, link your PC into the same network as the device. If your network does not have a DHCP server, you may have to adapt the IP address of your PC. With Microsoft® Windows® 7, proceed as follows:

1. Open: Start menu → Control Panel → Network and Internet (View network status and tasks) → Change adapter settings



LAN-Verbindung

Verbindung hergestellt:
Broadcom NetXtreme 57xx Gig...

2. Select your network (e.g., "Local Area Connection") and then the "Properties" entry in the context menu.
3. Select the "Internet Protocol Version 4 (TCP/IPv4)" entry in the list of elements and then click the **Properties** button below the selection list. The following dialog box opens:

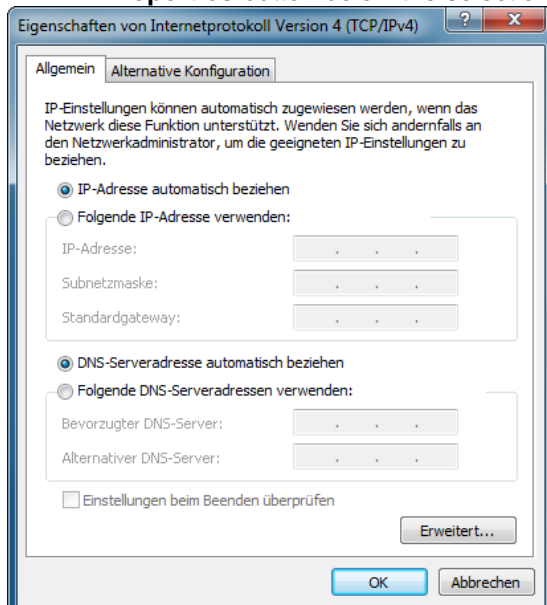

Activate the **Use the following IP address** option and select an address in the range 192.168.0.1–192.168.0.254 that has not yet been used for the IP address. Enter 255.255.255.0 for the subnet mask and confirm these settings.

2.5.3.2 Identifying an unknown sensor IP address

If you do not know the IP address of the sensor, either because it was assigned via DHCP or the information about the static IP address is no longer available, you can query the IP address in the following way:

1. Open a Windows prompt
2. Execute the command `ping OXH7-[identifier].local`. Replace `[identifier]` either with the eight-digit order number or the MAC address indicated on the sensor. Example: `ping OXH7-12345678.local` or `ping OXH7-11-22-33-44-55-66.local`
3. Read the IP address (here: `192.168.0.250`) from the command output:
`Ping is executed for OXH7-12345678.local [192.168.0.250] with 32 bytes of data:`

If you do not gain access to the sensor when you specify this IP address, change the IP configuration of your PC as follows:

1. Enter an IP address that comes either directly before or after the sensor IP address.
2. Enter `255.255.255.0` as the subnet mask.
3. Confirm the setting.

3 Configuration via the web interface

3.1 The web interface

The device includes an integrated web server which makes available a graphical user interface (GUI). This enables configuration and evaluation of the data (e.g., of machine control) directly via the browser.

3.1.1 Supported browsers

Due to differences in browser technology, there may be some differences in appearance between browsers and browser versions or even incompatibilities with the device. In our experience, these incompatibilities increase with the age of the browser due to a lack of standardization. We cannot test all browsers and their various releases, so untested browsers may also function with the device.

Supported browsers are Firefox 59 and Chrome 65.

3.1.2 Connecting to the web interface

1. Launch a supported browser
2. Enter the IP address of the sensor in the address line

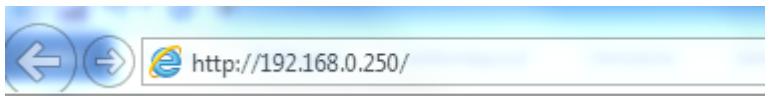

NOTE



The default IP address is 192.168.0.250

3.1.3 Overview of the web interface

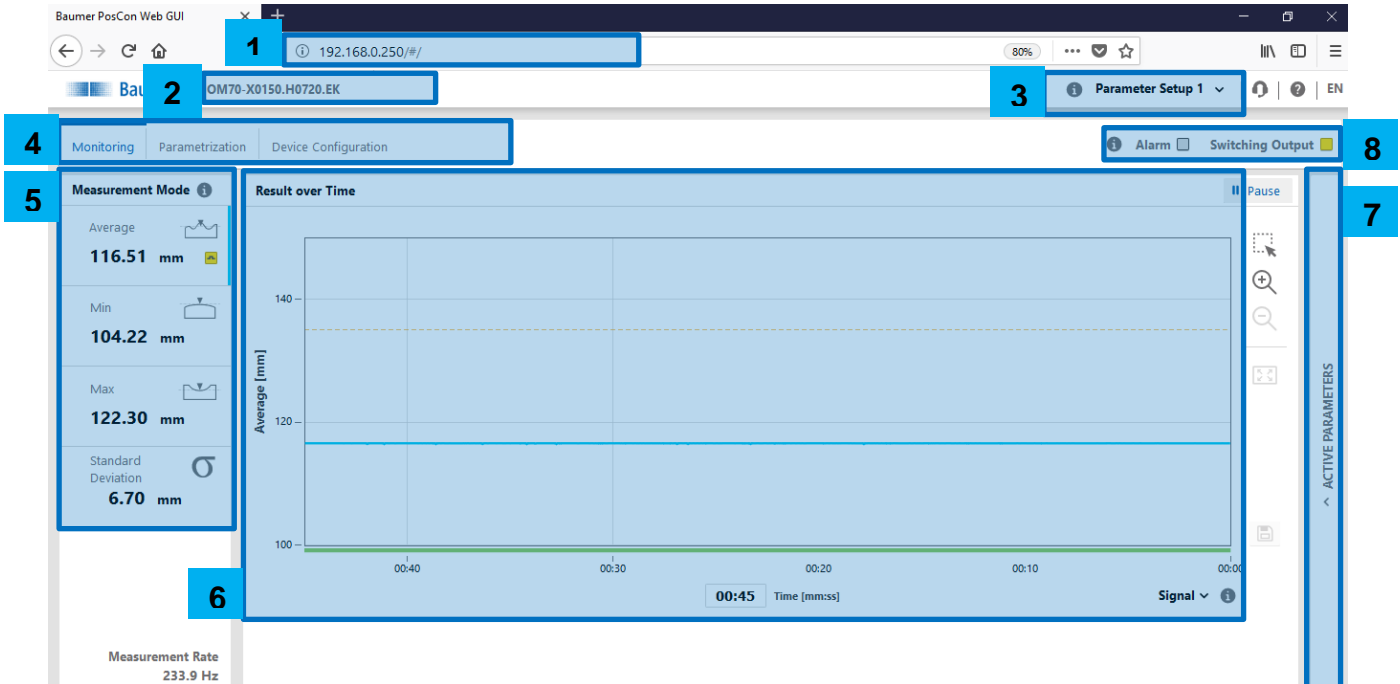

The screenshot shows the Baumer PosCon Web GUI interface. The browser address bar (1) displays the IP address 192.168.0.250/#/. The page title (2) is OM70-X0150.H0720.EK. The navigation menu (4) includes Monitoring, Parametrization, and Device Configuration. The Measurement Mode (5) panel shows Average (116.51 mm), Min (104.22 mm), Max (122.30 mm), and Standard Deviation (6.70 mm). The Result over Time (6) graph shows Average [mm] vs Time [mm:ss]. The Alarm (8) and Switching Output (8) status indicators are visible in the top right. The Active Parameters (7) sidebar is also present.

1. Sensor IP address
2. Commercial name of detected sensor
3. Selection of active parameter setup that is stored in the sensor
4. Setting the configuration or monitoring options
5. Selection of measurement mode
6. Output of measurement value and signal quality over time
7. Overview of active parameters
8. Status of alarm and switching output. Alarm: Red = Active; switching output: Yellow = Active

3.2 Monitoring

Output and evaluation of measurement values.

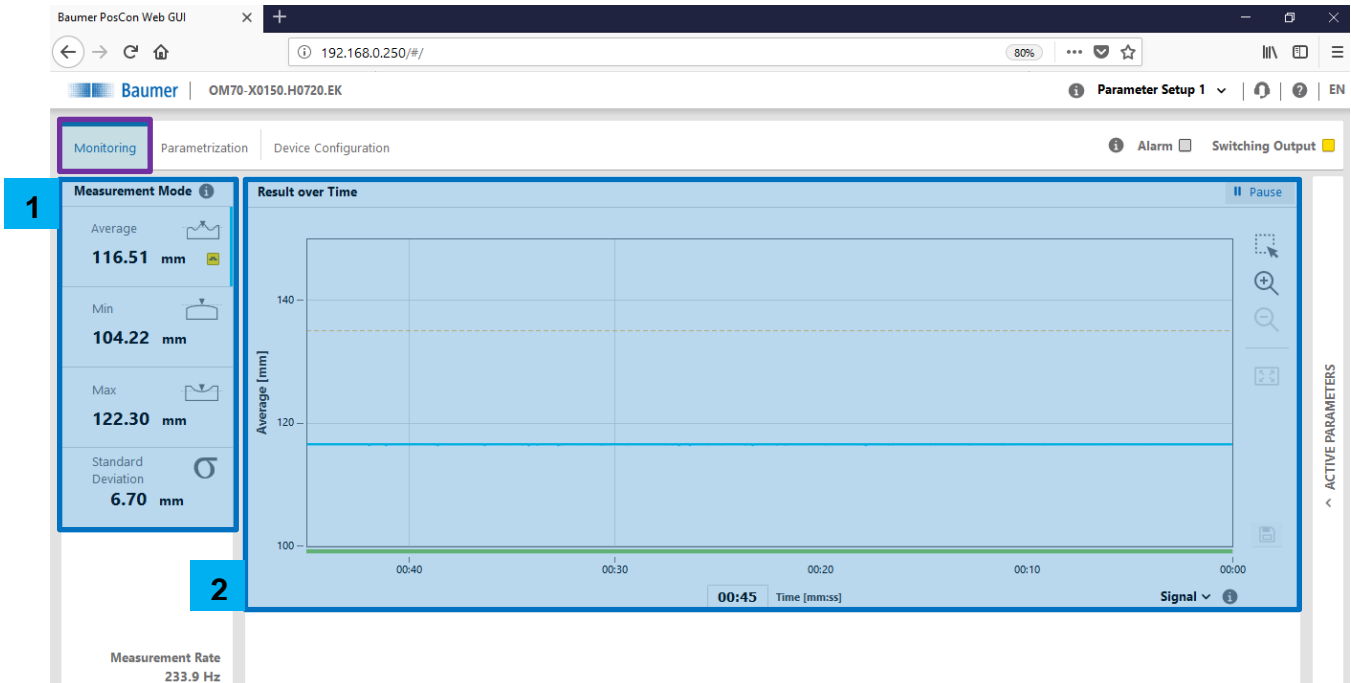

3.2.1 Measurement mode

The measurement mode is selected here to define which values are displayed in the "Result over Time" diagram. The mode that is currently selected is indicated by a blue line.

The yellow icon indicates the active measurement value of the switching output.

Avg DIST

Average distance to all measuring points.

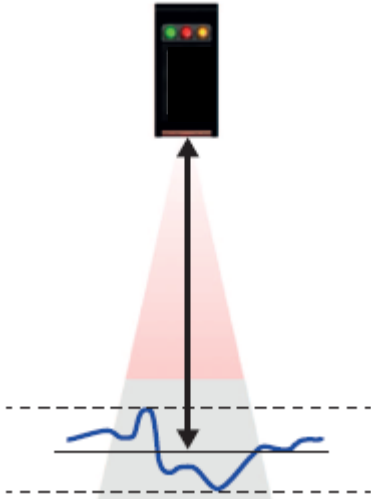

Max DIST

Distance to the furthest measuring point.

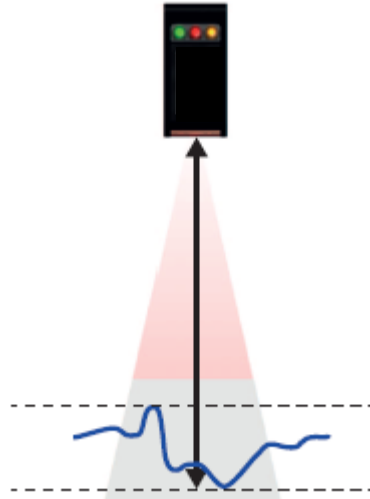

Min DIST

Distance to the nearest measuring point.

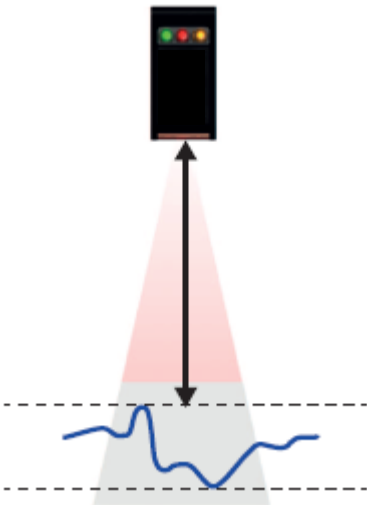



3.2.2 Result over time

3.2.2.1 Measurement values

The diagram displays the measurement values (blue) within the adjustable "timeframe". The gray background and gray line display the switching output window and switching point respectively.

3.2.2.2 Signal quality/switching output

The colored bar underneath the diagram displays either the signal quality or the switching output. This can be set by the user via the   button.

Signal quality

Green: Valid signal

Yellow: Weak signal

Red: No signal (no valid measurement value)

Switching output

Yellow: Switching output is active/high

Gray: Switching point is inactive/low

3.2.2.3 Save/Pause

Activating "Pause" freezes the diagram. During "Pause", you can click the disk icon to save the displayed measurement values to the PC in .csv format.

3.3 Parametrization

All application-specific settings are made here.

- 1- Result over time
- 2- Profile
- 3- Active parameter adjustment
- 4- Drag & drop lines
- 5- Selection Result over time & Profile or Result over time & Camera picture

3.3.1 Result over time & profile

3.3.1.1 Result over time

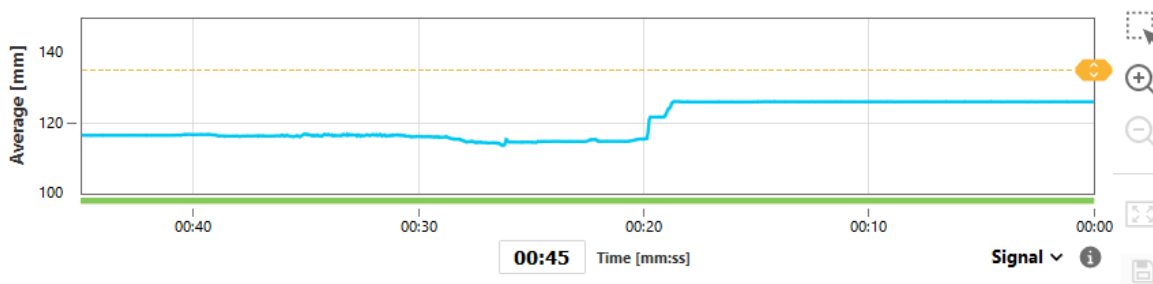

As in Monitoring mode, the diagram displays the measurement values (blue) within the adjustable "timeframe". The gray background and gray line display the switching output window and switching point respectively. The colored bar underneath the diagram displays the signal quality or the switching output.

Green: valid signal

Yellow: low signal

Red: no signal (No valid measurement value)

Here, the switching output can be adjusted using the yellow lines; these changes take effect immediately. With the tools on the right side the displayed diagram can be saved or analyzed.

3.3.1.2 Profile

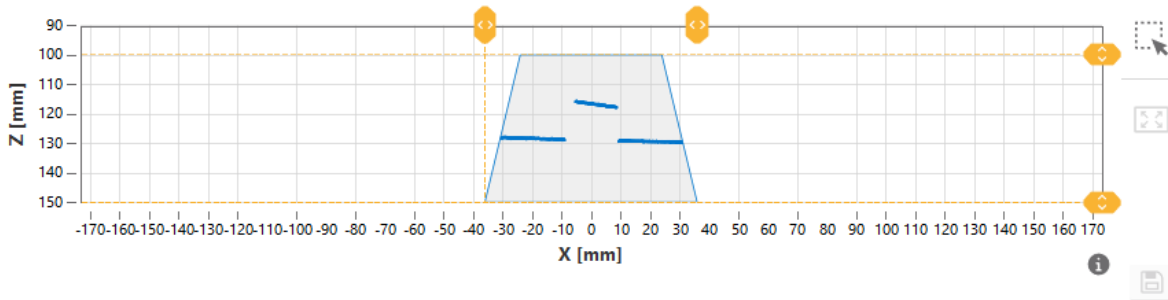

The diagram displays the profile points of the object. The field of view is shown in gray. Here, the field of view can be restricted using the yellow lines; these changes take effect immediately.

3.3.1.3 Camera picture

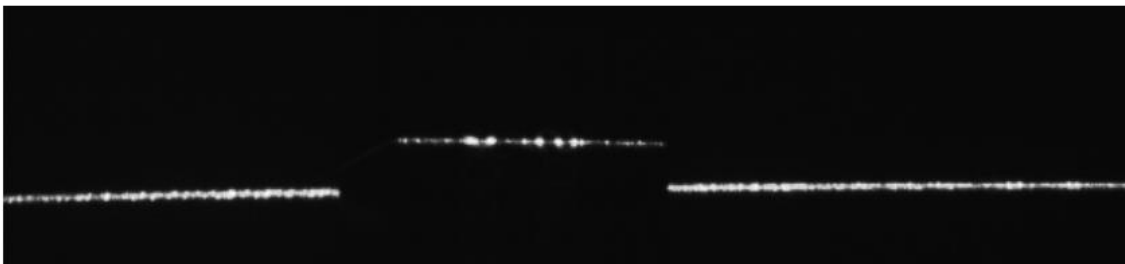

Output of the unfiltered camera image. For example, unwanted reflections can be detected and the alignment can be optimized.

3.3.2 Active parameters

3.3.2.1 Data Acquisition

3.3.2.1.1 Exposure time

To improve sensitivity to dark objects, the exposure time can be increased. This also changes the measuring repeat time.

Light object: Short exposure time for light, shiny, and reflective surfaces such as metal or white objects, for example.

Dark object: Longer exposure time and therefore slower measuring frequencies for plastics or black materials, for example.

NOTE



Sometimes, shiny surfaces may require a longer exposure time.

3.3.2.1.2 Trigger mode

For setting the measuring intervals.

Free running

Measurement with the max. possible frequency, which may vary depending on the application. The sensor measures continuously.

Interval

Measurement cycle with fixed internal interval (time in ms). The constant measuring frequencies that can be achieved are slower than the non-constant frequencies in free-running mode. The interval must be set accordingly.

NOTE



- If Sync-In (pin 8) is connected, free-running mode (or interval mode) runs when Sync-In is set to low
- If Sync-In is not connected, free-running mode (or interval mode) runs continuously

Single shot

A single measurement is triggered with the falling edge of an external trigger signal at the Sync-In. This measurement value is held at the outputs until the next falling edge. The measuring frequencies that can be achieved are only half as high as in free-running mode.

Sync-In

The measurement and signal output can be interrupted with the Sync-In input by connecting with high. As long as Sync-In is on high, the sensor delays the next measurement (hold) and reduces the power of the laser beam.

- The sensor checks Sync-In before every measurement
- The previous measurement cycle is always completed first, even if Sync-In is on high
- During the waiting time (Hold), the power of the laser beam is reduced
- While Hold is at high, all outputs are frozen at their last state
- To return the sensor to measurement mode, Sync-In must be set from high to low
- Sync-In must remain on low for at least 5 μ s in order for the sensor to begin measuring again

Sync-In	Level	Measurement
Sync-In low	0...2.5 V	Run
Sync-In high	8 V...UB (operating voltage)	Hold

Application example: Reciprocal influence

Only the laser beam of Sensor 1 may be in the field of view of Sensor 1. The laser of Sensor 2 must not influence Sensor 1.

If it is not possible to prevent several sensors from affecting each other through appropriate installation, however, the sensors affecting each other can be operated asynchronously using the Sync-In cable. The superordinate control generates the signals for this.

NOTE



As soon as the Sync-In is set to high (Hold), all output functions are frozen at their last state until the next measurement.

Measurement in case of Sync-In low:

Every time before a laser pulse is transmitted, the sensor checks the level at Sync-In. If it is low, the sensor immediately begins the next measurement.

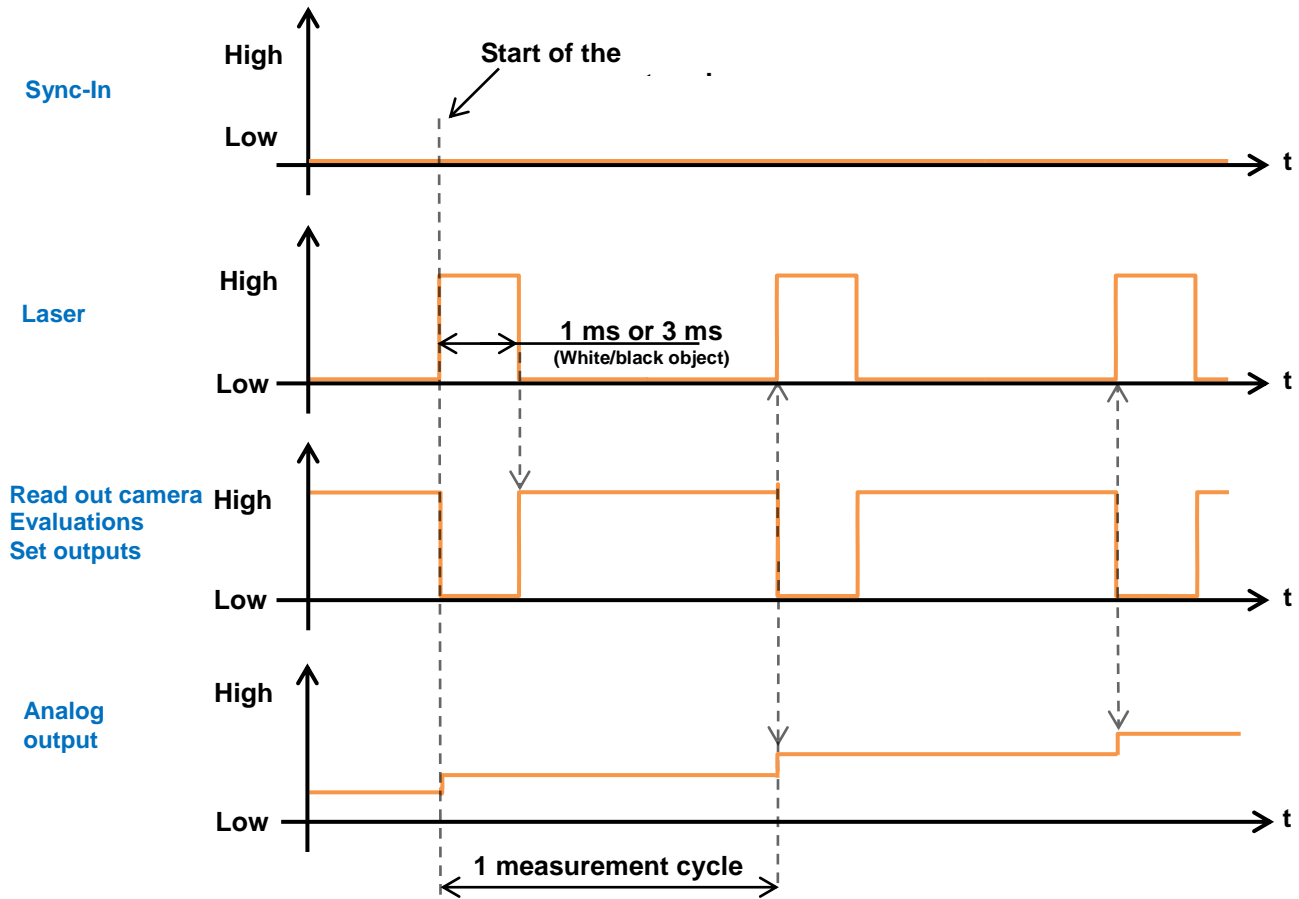

Sync-In low to high:

If the Sync-In level is on high, the sensor always finishes its initiated measurement and then holds off on doing the next measurement. All outputs are held (hold function).

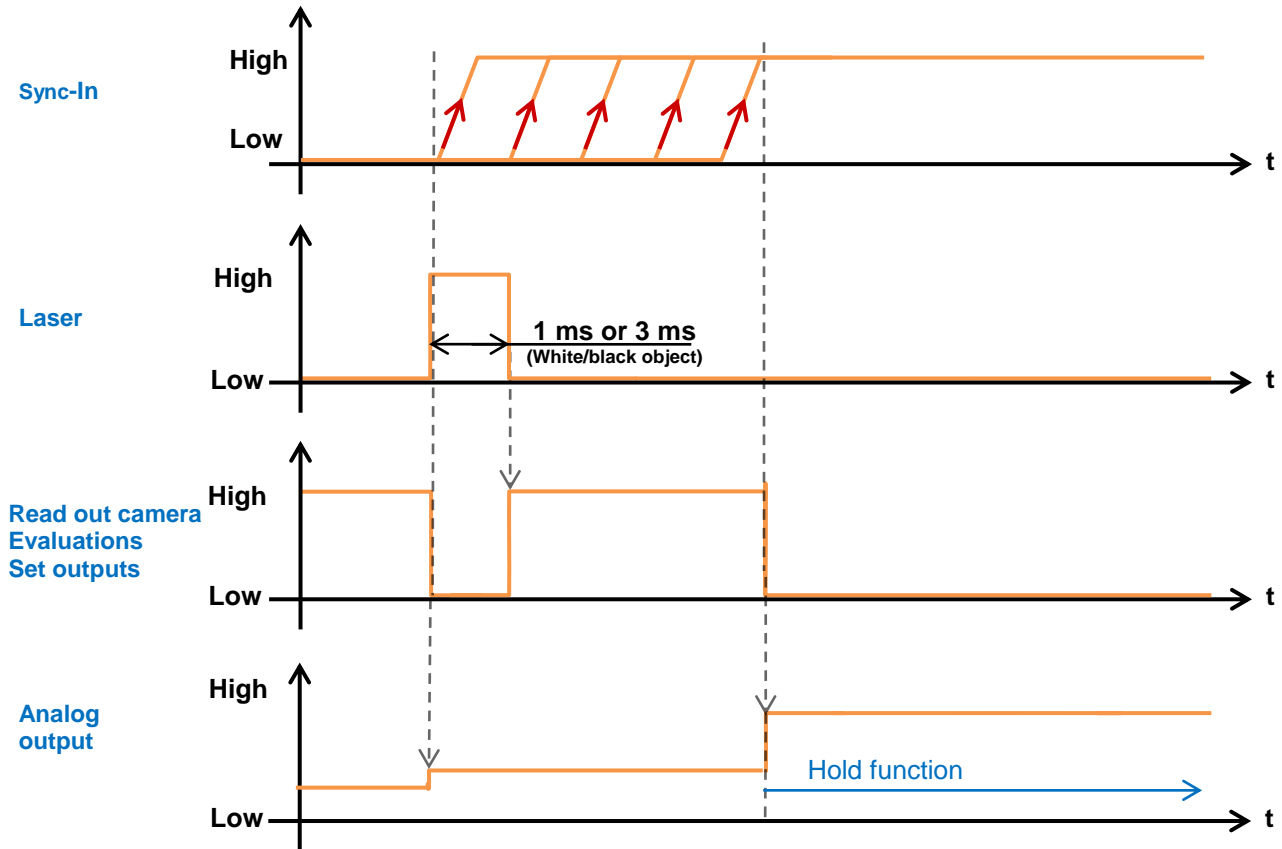

Sync-In high to low:

To return the sensor to measurement mode, Sync-In must be set from high to low. Sync-In must remain on low for at least 5 μ s in order for the sensor to begin measuring again.

If Sync-In switches from high to low level, the response time increases in the first measurement cycle by 5 μ s.

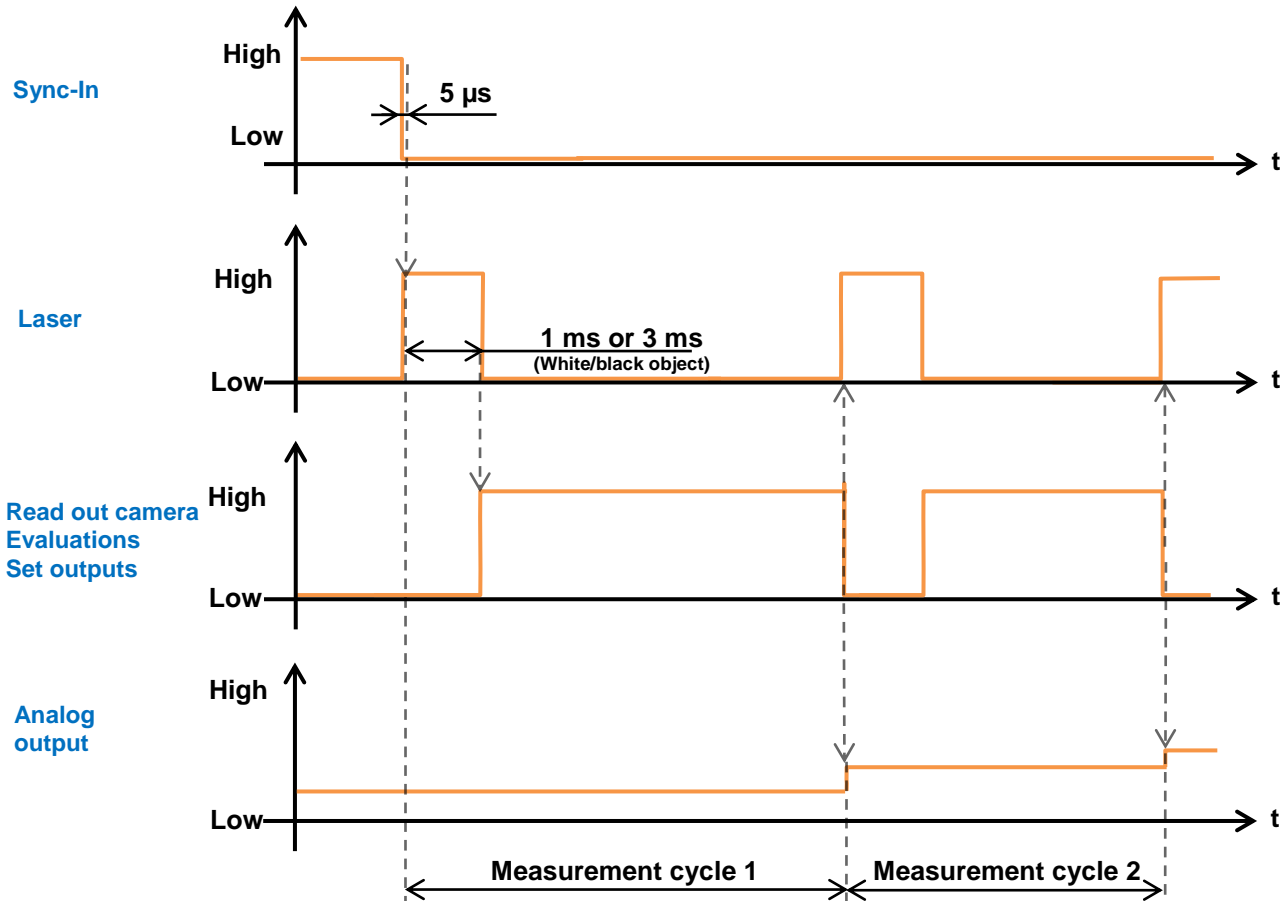

3.3.2.2 Field of view

Within the field of view function, the sensor can be installed at an angle or the field of view can be restricted.

3.3.2.2.1 Mounting assistant

The installation conditions can be checked using the mounting assistant. The angle of inclination as well as the distance to the reference surface are output.

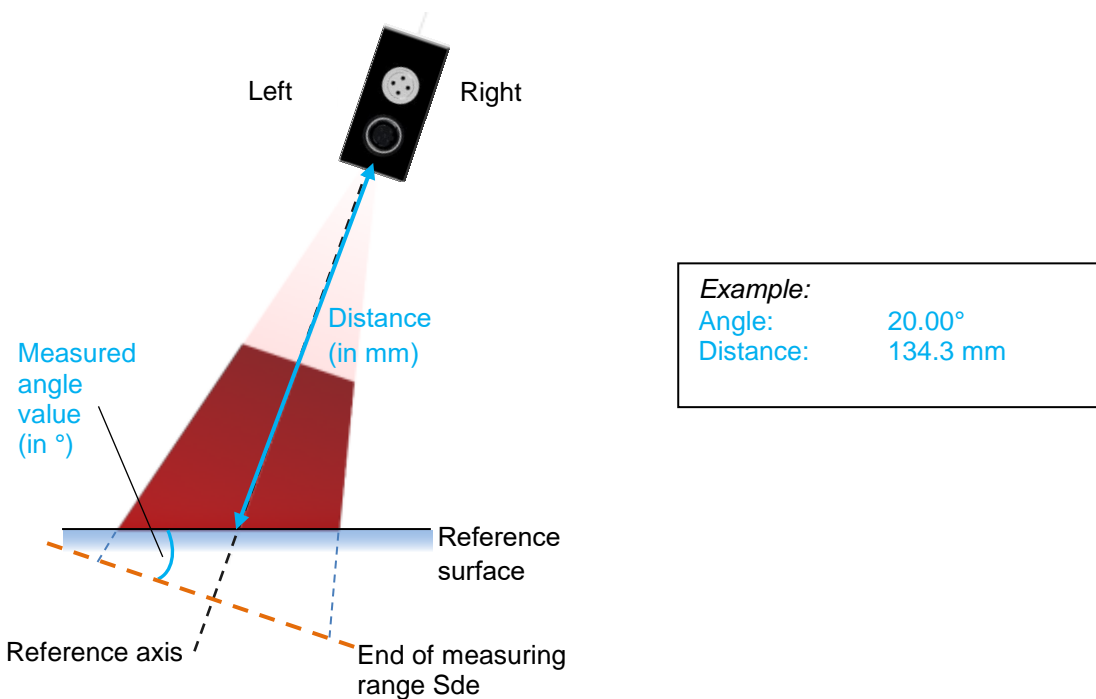

While the mounting assistant is activated, the field of view is set to max. and the sensor outputs are set to "no object in the measuring range". Once the mounting assistant has finished, the last valid settings are re-activated.

3.3.2.2 Field of view limits

All measurement values outside the set field of view are ignored. This is particularly useful if, for example, the field of view contains an unwanted object that is not to be detected.

The field of view is adapted by software so the width of the visible laser beam does not change.

For full flexibility, every value in the field of view can be individually adjusted. The modified field of view need not be symmetrical. Even a single limit, e.g., Left Limit, can be restricted.

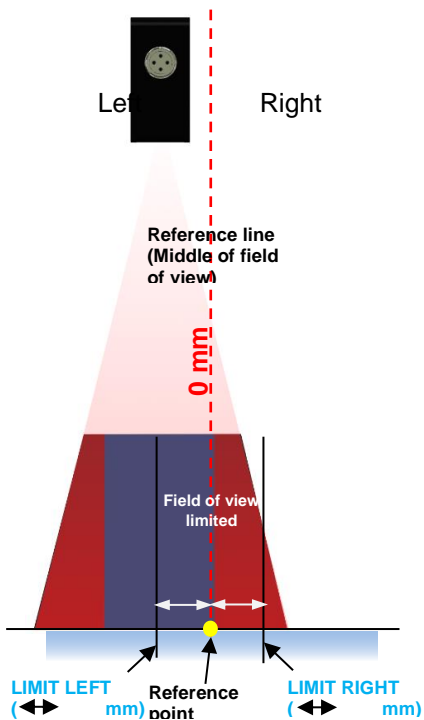

NOTE

The minimum width of the field of view (Left Limit to Right Limit) must be at least 2 mm

Set FOV to Max

Resets all restrictions of the field of view back to the default settings (maximum field of view).

3.3.3 Outputs and filters

With Pin 4 (out), the user has a configurable switching output.

Pin 4 becomes active as soon as the defined value (point or window) is exceeded or not reached (active high or active low depending on the setting).

For a reliable switching signal, there is a hysteresis¹ which is active in one direction.

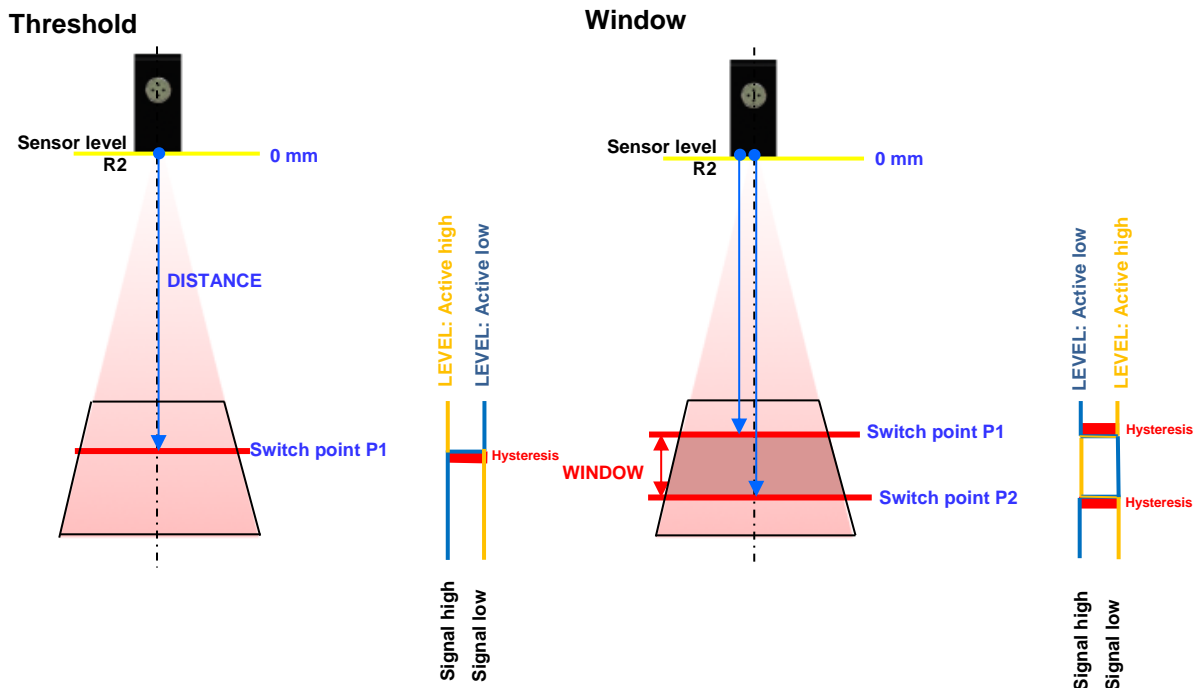

3.3.3.1 Switching output

Whether the switching output (Pin 4) is to be operated in **point** mode (switch point P1) or in **window** mode (switch point P1 and switch point P2) is defined here.

Switch point P1 must be larger than switch point P2.

The window must be larger than the "minimum switching window" specified in the data sheet.

3.3.3.1.1 Polarity

The output level can be inverted with **active high** or **active low** here.

NOTE

It is not recommended to set switch points equal to field of view limits. In combination with the hysteresis this results in a complex switching behavior.

¹ In accordance with chapter Sensor data sheet

3.3.3.2 Precision filter

Activating filtering can reduce noise and thus increase resolution and repeat accuracy.

Standard	= normal resolution ¹²
High	= resolution is approximately twice as high ¹² , measuring rate is reduced
Very high	= resolution about three times as high ¹² , measuring rate is reduced

3.3.3.2.1 Influences of the filter

The higher the precision is set, the more response times and release times increase, which means that the response time for moving objects slows down. The measuring frequency is not affected by the use of this filter.

The precision filter works with moving median as well as moving average filters.

3.3.3.2.2 Moving median

The median of a finite list is the measurement with the middle measurement value of a string of numbers (e.g., median of {3, 3, 5, 9, 11} is 5). The number of measurement values saved in an array is called the number of measurement values, e.g., {3, 3, 5, 9, 11} corresponds to 5 measurement values. When a new measurement value is added, the oldest is removed (moving filter). A sudden change in measurement values will only lead to a change after half of the saved number of measurement values (e.g., number of measurement values = 5 means that the measurement value at the output is only affected after 3 measurement values).

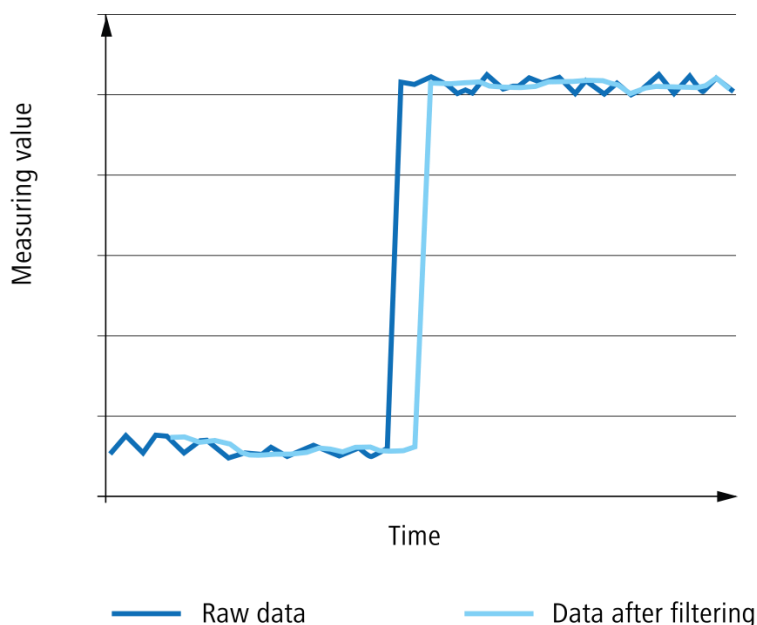

This diagram shows the effects of the median (number of measurement values 5). The filter is used to suppress measurement errors. The output only changes after a defined number of measurement values (number of measurement values/2). The measuring frequency is not affected by this filter, but the response time is.

¹ In accordance with chapter Sensor data sheet

² Depending on the object to be measured

3.3.3.2.3 Moving average

The output value of the moving average filter is the average of the defined number of measurement values which have been saved. When a new measurement value is added, the oldest is removed (moving filter).

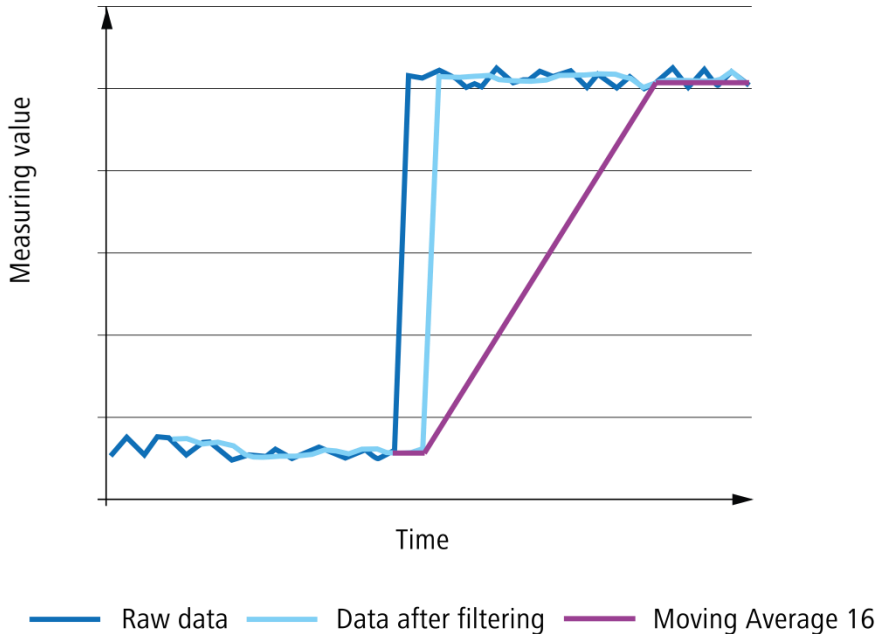

As shown in the diagram, the moving average evens out the output value. In contrast to the median filter, it is possible that with the moving average, the displayed measurement values were never measured as such. The measuring frequency is not affected by this filter, but the response time is.

Number of measurement values required until the correct measurement value is displayed:

- When set to "High", the distance must be stable for 4 + 16 measurement values before the correct value is displayed
- When set to "Very high", the distance must be stable for 8 + 128 measurement values before the correct value is displayed

Example

Calculate the response time with a measuring frequency of 500 Hz

$$1 / 500 \text{ Hz} = \mathbf{0.002 \text{ s}}$$

$$\text{Median} = 7 / 2 \text{ (formula: measurement values / 2)} = \mathbf{4}$$

$$\text{Average} = \mathbf{16}$$

$$\text{Response time} = \mathbf{0.002 * (4 + 16) = 0.04 \text{ s} = 40 \text{ ms}}$$

3.3.3.3 Hysteresis

The hysteresis is the difference between the switch on threshold and the switch off threshold, and is specified as a value in mm. Without hysteresis H , objects in the border area of the switching point could lead to a toggling of the switching output. For reasons of reliability, the use of hysteresis is recommended (at least as great as the resolution of the sensor).

The hysteresis can be located before (negative hysteresis) or after (positive hysteresis) a switch point.

Example: switch point with positive hysteresis

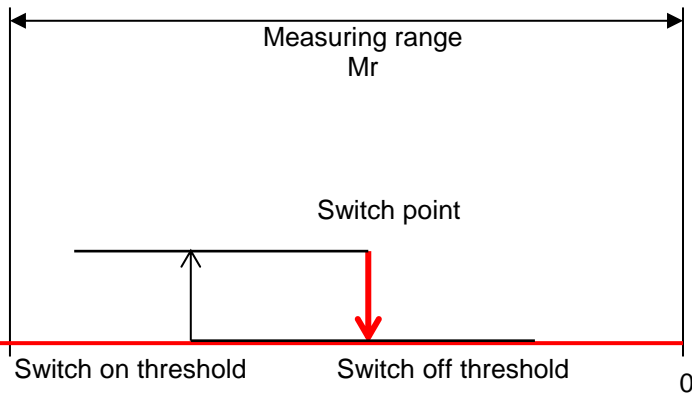
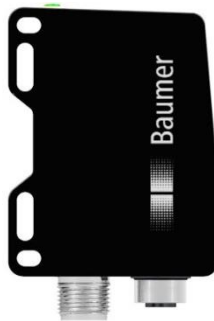

Example: switch point with negative hysteresis

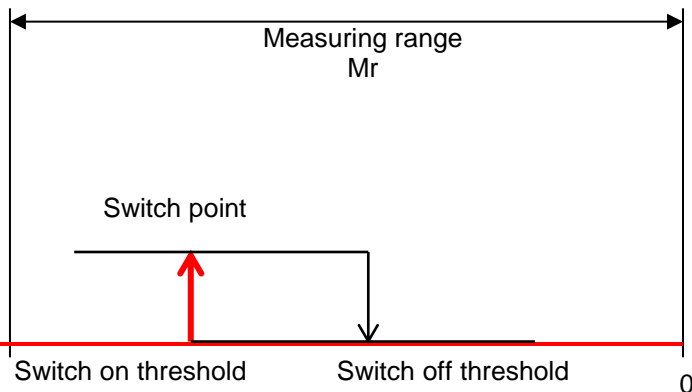
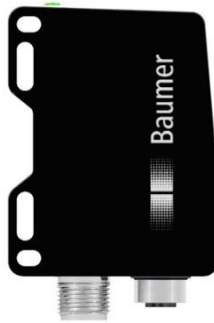

Behavior of the switching output for point mode

Example: Hysteresis positive

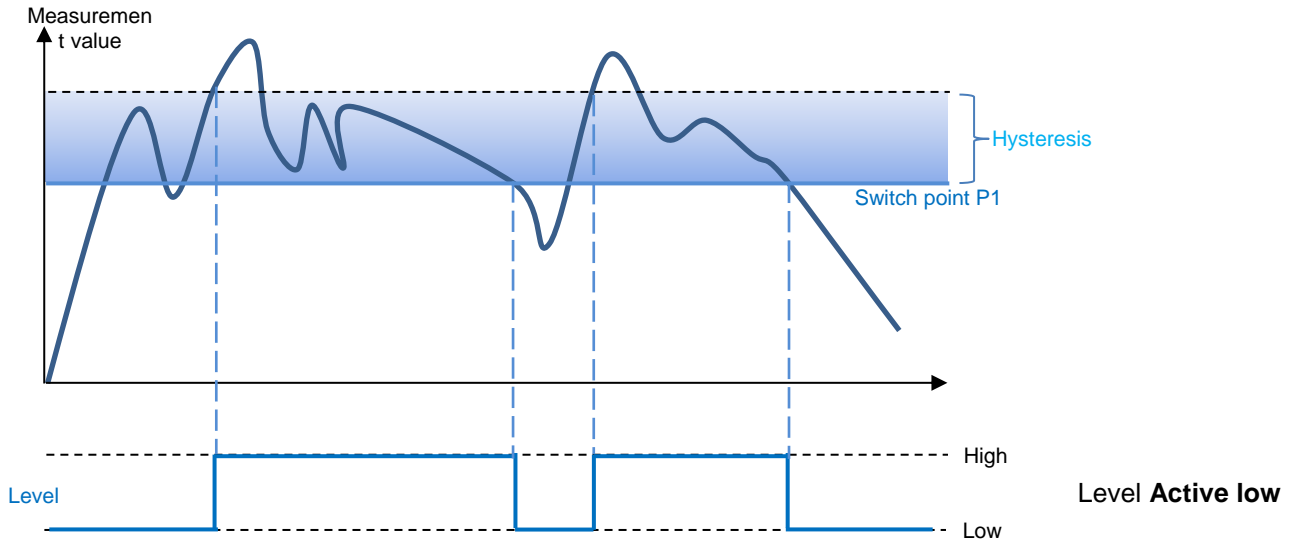

Example: Hysteresis negative

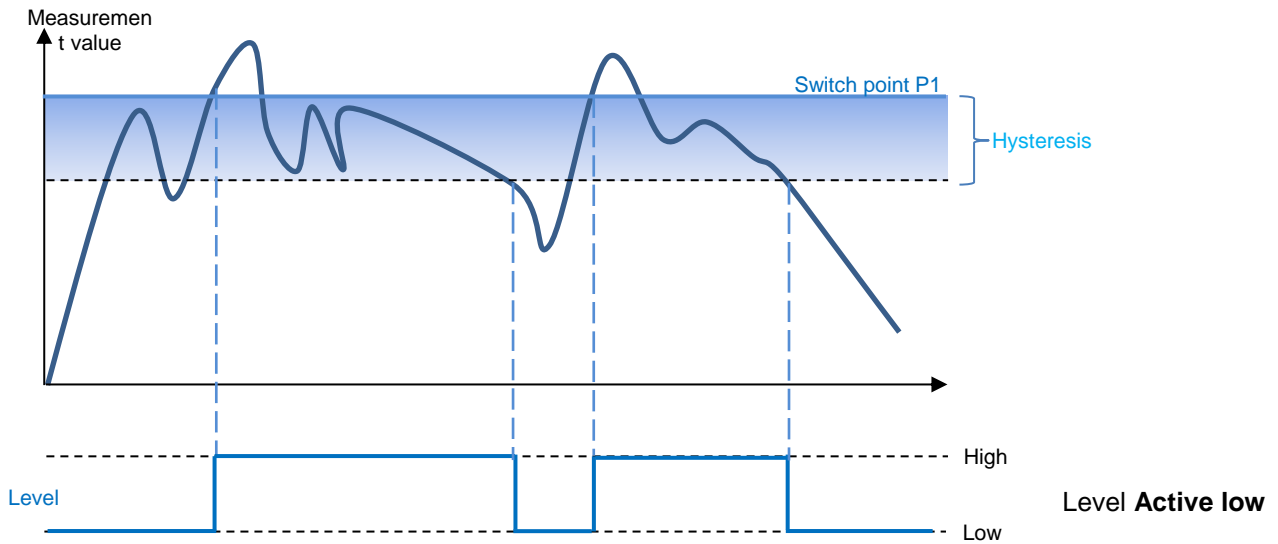

Behavior of the switching output for window mode

Example: Hysteresis positive

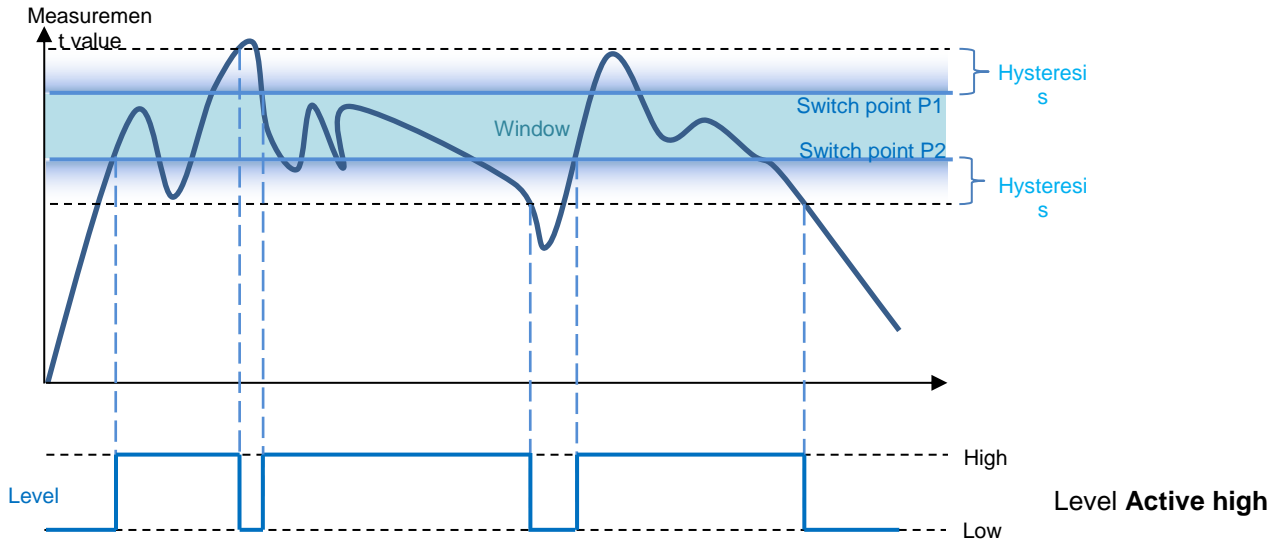

Example: Hysteresis negative

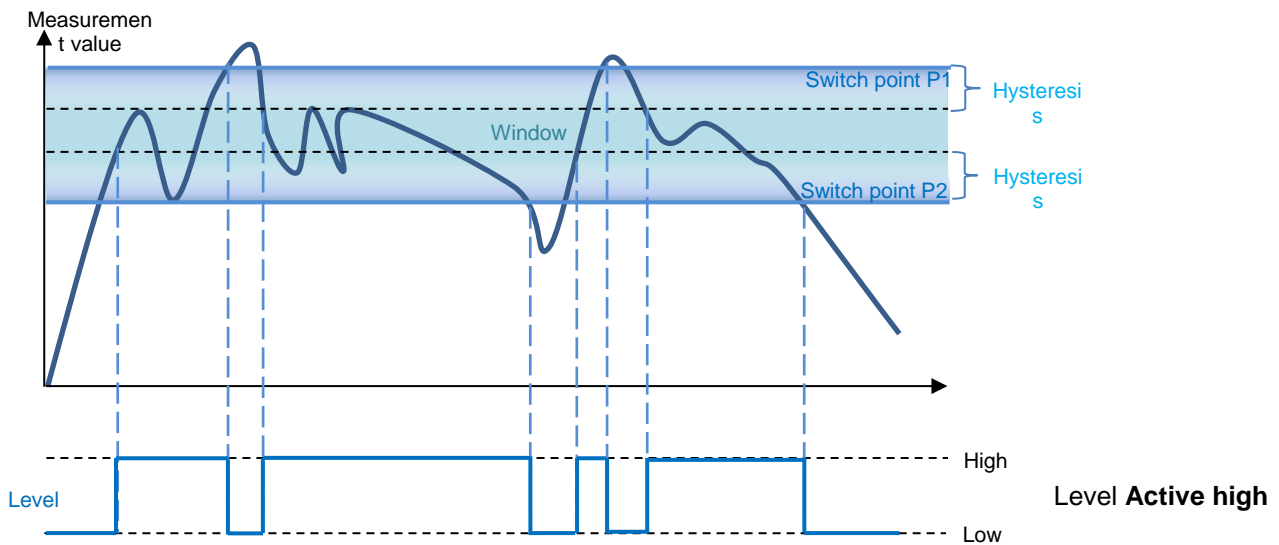

3.3.3.4 Alarm output

The alarm output cannot be adjusted and is output as a push-pull signal (active high).

Situation	Red LED	Alarm output out2
No object inside the measuring range	On	High
Signal gain reached	Off	Low
Signal gain not reached	Flashes (8 Hz)	Low

NOTE

There is no excess gain hysteresis, which is why rapid switching between alarms can occur.

3.3.3.4.1 Behavior of the alarm output

If there is no object inside the measuring range, the sensor will retain the last valid measurement value. The alarm output is high during this time.

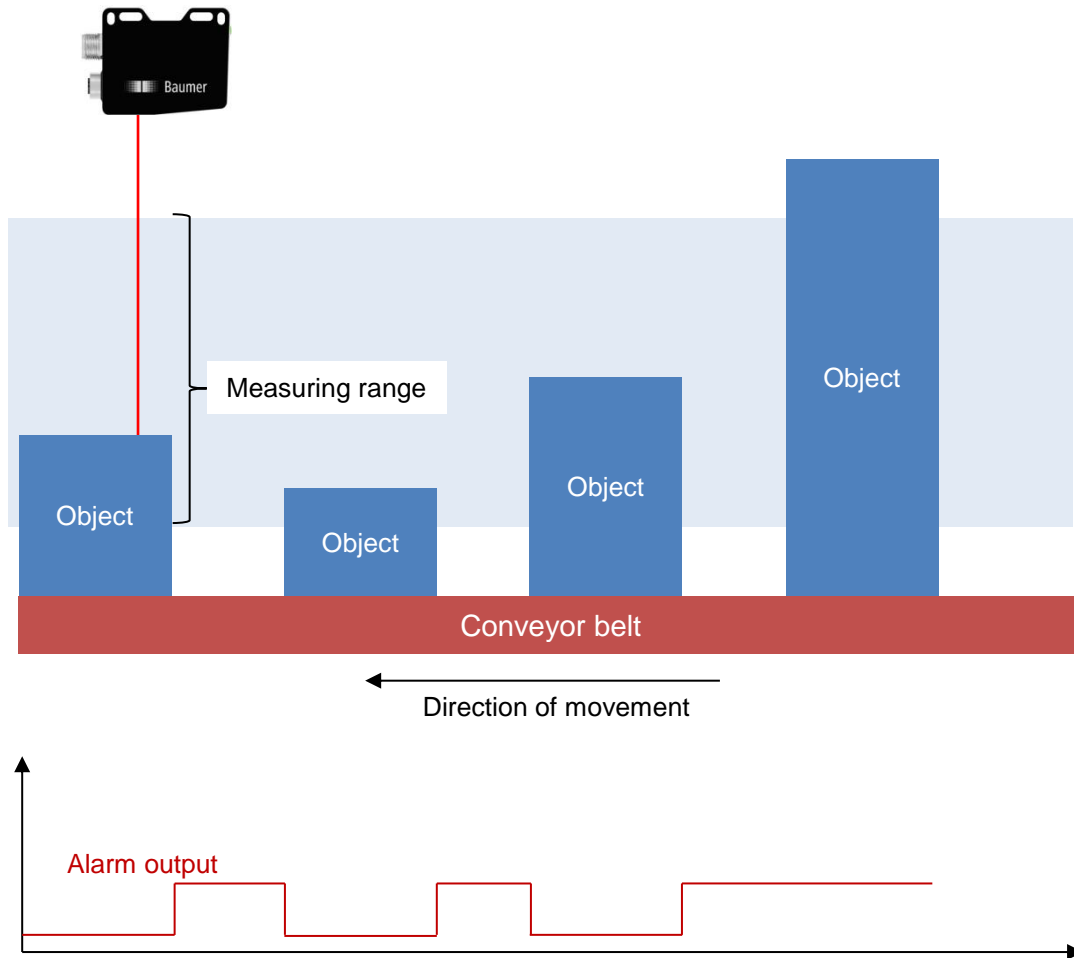

3.3.3.5 Storing parameters

The parameter changes can be stored in one of three parameter setups in the sensor so that the settings are also available once the sensor has been restarted.

"Unsaved parameters" means that changes were made without saving them in one of the parameter setups.

3.4 Device Configuration

The device-specific settings are made here.

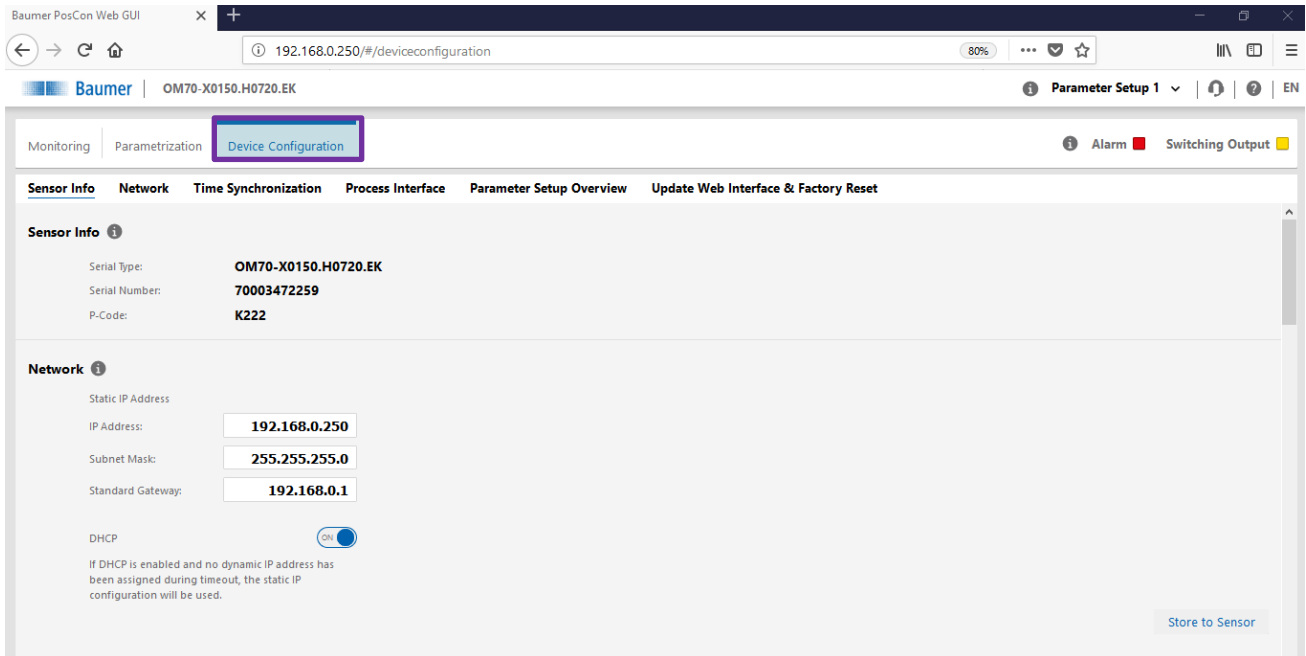

3.4.1 Sensor Info

Displays important sensor information such as the serial type, serial number, and P-Code.

NOTE



Note: This information should be made available in the event of a service request.

3.4.2 Network

Choice between static and dynamic address configuration using DHCP. If DHCP fails, the static address is used.

3.4.2.1 Static IP address

The device uses a set IP address. This requires the IP address, subnet mask, and the standard gateway to be specified.

3.4.2.2 DHCP (Dynamic Host Configuration Protocol)

If a DHCP server is integrated in the same network, the IP address is determined from there. If this does not happen within a specific time and a timeout occurs, the set IP address specified below is used.

3.4.3 Time synchronization

Activation/deactivation of the NTP synchronization. If activated, the sensor synchronizes its internal clock with the defined network time server.

The time stamps for the measurement values are set based on the synchronization. The time basis is UTC.

Note: The daylight saving time functionality is not supported.

3.4.4 Process Interface

Activate or deactivate the Modbus TCP and OPC UA functionality by toggling the "on / off" button. When set to "off", the sensor no longer responds to requests via this protocol.

3.4.5 Parameter Setup Overview

Displays the stored values for the parameter setups. The parameter setups are presented in a general overview here.

3.4.6 Update Web Interface & Factory Reset

A new web interface can be uploaded and the factory settings reset here.

Displays the web interface version and date. "Update Web Interface" updates the web interface if a new version has been released.

Activating "Factory Reset" resets the device to the factory settings.

NOTE



In order to maintain the connection to the sensor, the network configuration (IP address, time server, process interface) is not reset to factory settings.

4 Communication via the process interfaces

4.1 Introduction

In addition to the configuration option via the integrated web server, the sensor supports Modbus TCP and OPC UA – two standardized automation technology protocols for configuring and retrieving measurement values.

4.1.1 Dependencies

The sensor supports one client connection for each protocol. Read access via the protocols is possible at any time. Write access is only permitted once the sensor has been moved to Configuration mode via the respective interface. Only one interface can be in Configuration mode at one time. The measuring frequency that can be achieved may be reduced in such cases.

4.1.2 Description of the commands

See chapter "Configuration via the web interface".

4.2 Modbus TCP

Modbus TCP is a protocol with a long history which is supported by a large number of programmable logic controllers as standard or which can easily be retrofitted using a software module. Libraries for various programming languages are available for PC-based systems. The standard is freely available on the website of the Modbus Organization (<http://www.modbus.org>).

4.2.1 Protocol parameters

The Modbus TCP server integrated in the sensor (Modbus TCP slave) can be addressed using the following parameters:

- TCP port no.: 502
- Modbus TCP unit identifier: 1

4.2.2 Mapping the sensor functionality to the Modbus data model

The sensor functionality can be accessed by reading or writing entries in the "Discrete inputs", "Input registers", and "Holding registers" tables. The following Modbus function codes (FC) are supported here:

- Read Discrete Inputs (FC 02)
- Read Input Registers (FC 04)
- Read Holding Registers (FC 03)
- Write Single Holding Register (FC 06)
- Write Multiple Holding Registers (FC 16)

The three tables are independent of one another, meaning that the same address can represent a different functionality in the different tables. The number of the register to be read or written with a Modbus command must match the length specified for the respective sensor functionality. It is not possible to read or write just some of the parameters.

If the data type of a sensor parameter is wider than a 16-bit Modbus register, the parameter is split across several Modbus registers. In such cases, the lower-value bits are placed on the lower address and the higher-value bits on the higher address.

4.2.3 Modbus TCP commands: Holding register

4.2.3.1 Overview of index commands for holding register function 03/6/16

Address	Length	Command
0	1	Enter Config Mode
1	1	Leave Config Mode
2	2	Session Timeout
10	1	Get DHCP Client State
11	4	Set IP Address
15	4	Set Subnet Mask
19	4	Set Gateway Address
27	1	Store Eth Parameters
32	1	OPC UA State
50	1	Time Sync Mode
51	4	NTP Server 1
55	4	NTP Server 2
100	1	Exposure Time
101	1	Precision
200	8	Field of View
220	1	Set Field of View to Maximum
300	11	Switching Output Configuration
400	8	Trigger Mode Settings
410	1	Laser ON/OFF
500	1	Store Setting
501	1	Load Setting
502	1	Reset Setting
503	1	Sensor Reset

4.2.3.2 Address 0 - Enter Config Mode

Durch das Schreiben eines beliebigen Wertes in dieses Register wird der Sensor in den Parametriermodus versetzt. Der Schreibbefehl schlägt fehl, wenn der Sensor bereits über ein anderes Interface in den Parametriermodus versetzt wurde.

Function	Holding Register (FUNCTION 03/06/16)		
Address	0		
Length	1		
Access	Write Only		
Address	Parameter Description	Data Type	
0	Enter Config Mode: The command does not care, which number is written.	uint16_t	

4.2.3.3 Address 1 - Leave Config Mode

Durch das Schreiben eines beliebigen Wertes in dieses Register wird der Parametriermodus verlassen, sofern er zuvor über dieses Interface angefordert wurde.

Function	Holding Register (FUNCTION 03/06/16)
Address	1
Length	1
Access	Write Only

Address	Parameter Description	Data Type
1	Leave Config Mode: The command does not care, which number is written.	uint16_t

4.2.3.4 Address 2 - Session Timeout

Das Session Timeout ist die Zeitspanne, nach welcher der Sensor den über Modbus TCP angeforderten Parametriermodus automatisch wieder verlässt, sofern in der Zwischenzeit kein weiterer Befehl erfolgte.

Function	Holding Register (FUNCTION 03/06/16)
Address	2
Length	2

Address	Parameter Description	Data Type
2	Session Timeout [sec] (first 2 bytes)	uint32_t
3	Session Timeout [sec] (second 2 bytes)	

4.2.3.5 Address 10 - DHCP Client State

Aktiviert oder deaktiviert den DHCP Client.

Function	Holding Register (FUNCTION 03/06/16)
Address	10
Length	1

Address	Parameter Description	Data Type
10	DHCP State 0: Not Active / 1: Active	uint16_t

4.2.3.6 Address 11 - Set IP Address

Schattenregister zum Setzen der IP-Adresse des Sensors. Nach dem Schreiben dieses Eintrags können noch die Subnetzmaske und die Standard Gateway-Adresse gesetzt werden. Die Änderungen werden erst nach Ausführen des „Store Ethernet Parameters“-Befehls aktiviert.

Function	Holding Register (FUNCTION 03/06/16)
Address	11
Length	4
Access	Write Only

Address	Parameter Description	Data Type
11	IP Address Byte 0	uint16_t
12	IP Address Byte 1	uint16_t
13	IP Address Byte 2	uint16_t
14	IP Address Byte 3	uint16_t

4.2.3.7 Address 15 - Set Subnet Mask

Schattenregister zum Setzen der Subnetzmaske des Sensors. Nach dem Schreiben dieses Eintrags können noch die IP-Adresse und die Standard Gateway-Adresse gesetzt werden. Die Änderungen werden erst nach Ausführen des „Store Ethernet Parameters“-Befehls aktiviert.

Function	Holding Register (FUNCTION 03/06/16)
Address	15
Length	4
Access	Write Only

Address	Parameter Description	Data Type
15	Subnet Mask Byte 0	uint16_t
16	Subnet Mask Byte 1	uint16_t
17	Subnet Mask Byte 2	uint16_t
18	Subnet Mask Byte 3	uint16_t

4.2.3.8 Address 19 - Set Gateway Address

Schattenregister zum Setzen der Standard Gateway-Adresse des Sensors. Nach dem Schreiben dieses Eintrags können noch die IP-Adresse und die Subnetzmaske gesetzt werden. Die Änderungen werden erst nach Ausführen des „Store Ethernet Parameters“-Befehls aktiviert.

Function	Holding Register (FUNCTION 03/06/16)
Address	19
Length	4
Access	Write Only

Address	Parameter Description	Data Type
19	Gateway Address Byte 0	uint16_t
20	Gateway Address Byte 1	uint16_t
21	Gateway Address Byte 2	uint16_t
22	Gateway Address Byte 3	uint16_t

4.2.3.9 Address 27 - Store Eth Parameters

Durch das Schreiben eines beliebigen Wertes in dieses Register wird die zuvor gesetzte IP-Konfiguration aktiviert.

Function	Holding Register (FUNCTION 03/06/16)
Address	27
Length	1
Access	Write Only

Address	Parameter Description	Data Type
27	Store Ethernet parameters: The command does not care, which number is written.	uint16_t

4.2.3.10 Address 32 - OPCUA State

Function	Holding Register (FUNCTION 03/06/16)
Address	32
Length	1

Address	Parameter Description	Data Type
32	OPCUA State: 0 = Disable OPCUA 1 = Enable OPCUA	uint16_t

4.2.3.11 Address 50 - Time Sync Mode

Function	Holding Register (FUNCTION 03/06/16)
Address	50
Length	1

Address	Parameter Description	Data Type
---------	-----------------------	-----------

50	Synchronization Mode 0 = Internal 1 = NTP	uint16_t
----	---	----------

4.2.3.12 Address 51 - NTP Server 1

Function	Holding Register (FUNCTION 03/06/16)
Address	51
Length	4

Address	Parameter Description	Data Type
51	NTP Server IP Address Byte 0	uint16_t
52	NTP Server IP Address Byte 1	uint16_t
53	NTP Server IP Address Byte 2	uint16_t
54	NTP Server IP Address Byte 3	uint16_t

4.2.3.13 Address 55 - NTP Server 2

Function	Holding Register (FUNCTION 03/06/16)
Address	55
Length	4

Address	Parameter Description	Data Type
55	NTP Server IP Address Byte 0	uint16_t
56	NTP Server IP Address Byte 1	uint16_t
57	NTP Server IP Address Byte 2	uint16_t
5	NTP Server IP Address Byte 3	uint16_t

4.2.3.14 Address 100 - Exposure Time

Function	Holding Register (FUNCTION 03/06/16)
Address	100
Length	1

Address	Parameter Description	Data Type
---------	-----------------------	-----------

100	Exposure Time Mode 0 = Short 1 = Long	uint16_t
-----	---	----------

4.2.3.15 Address 101 - Precision

Function	Holding Register (FUNCTION 03/06/16)
Address	101
Length	1

Address	Parameter Description	Data Type
101	Precision Mode 0 = Normal 1 = High 2 = Very High	uint16_t

4.2.3.16 Address 200 - Field of View

Function	Holding Register (FUNCTION 03/06/16)
Address	200
Length	8

Address	Parameter Description	Data Type
200 -201	Limit Left [mm]	float32_t
202 -203	Limit Right [mm]	float32_t
204 -205	Limit Near [mm]	float32_t
206 - 207	Limit Far [mm]	float32_t

4.2.3.17 Address 220 - Field of View to MAX

Das Schreiben eines beliebigen Wertes in dieses Register setzt das Field of View auf seine maximal mögliche Größe.

Function	Holding Register (FUNCTION 03/06/16)
Address	220
Length	1
Access	Write Only

Address	Parameter Description	Data Type
220	Set Field of View: The command does not care, which number is written.	uint16_t

4.2.3.18 Address 300 - Switching Output Configuration

Function	Holding Register (FUNCTION 03/06/16)
Address	300
Length	11

Address	Parameter Description	Data Type
300 - 301	Switch Point 1	float32_t
302 - 303	Switch Point 2	float32_t
304 - 305	Switch Mode 1 = Point 2 = Window	int32_t
306 - 307	Hysteresis	float32_t
308 - 309	Measurement Value 0 = Average 1 = Max 2 = Min	int32_t
310	Polarity 0 = Active Low 1 = Active High	uint16_t

4.2.3.19 Address 400 - Trigger Mode Settings

Function	Holding Register (FUNCTION 03/06/16)
Address	400
Length	8

Address	Parameter Description	Data Type
400 - 401	Trigger Mode 0 = FreeRunning 1 = SingleShot 2 = Interval 3 = Internal (not setable)	int32_t

402 - 403	Fixed Trigger Time [us]	uint32_t
404 - 405	Minimal Fixed Trigger Time [us] (don't care on write)	uint32_t
406 - 407	Maximal Fixed Trigger Time [us] (don't care on write)	uint32_t

4.2.3.20 Address 410 - Laser On/Off

Function	Holding Register (FUNCTION 03/06/16)
Address	410
Length	1

Address	Parameter Description	Data Type
410	Laser State 0 = Off 1 = On	uint16_t

4.2.3.21 Address 500 - Store Setting

Speichert die geraden aktiven Parameter in ein Parameter-Setup.

Function	Holding Register (FUNCTION 03/06/16)
Address	500
Length	1
Access	Write Only

Address	Parameter Description	Data Type
500	Parameter-Setup Nr. (1,2 or 3)	uint16_t

4.2.3.22 Address 501 - Load Setting

Lädt ein Parameter-Setup.

Function	Holding Register (FUNCTION 03/06/16)
Address	501
Length	1
Access	Write Only

Address	Parameter Description	Data Type
501	Parameter-Setup Nr. (1,2 or 3)	uint16_t

4.2.3.23 Address 502 - Reset Setting

Setzt ein Parameter-Setup auf den Auslieferungszustand zurück.

Function	Holding Register (FUNCTION 03/06/16)
Address	502
Length	1
Access	Write Only

Address	Parameter Description	Data Type
502	Parameter-Setup Nr. (1,2 or 3)	uint16_t

4.2.3.24 Address 503 - Sensor Reset

Function	Holding Register (FUNCTION 03/06/16)
Address	503
Length	1
Access	Write Only

Address	Parameter Description	Data Type
503	Sensor Reset (don't care)	uint16_t

4.2.4 Modbus TCP commands: Input register

4.2.4.1 Overview of index commands for input register function 04

Address	Length	Command
0	33	Vendor Information
40	45	Device Information
90	5	Frontend Version
100	6	Read Eth Config
120	6	MAC Address
150	12	Get Field of View Limits
200	17	Get All Measurements
250	14	Get Teachable Range
300	4	Live Monitor
400	1	Unsaved Config
401	1	Active Setting Number
410	25	Get Setting 1
450	25	Get Setting 2
490	25	Get Setting 3
600	108	Get Block Mode Memory 0
708	108	Get Block Mode Memory 1
816	108	Get Block Mode Memory 2
924	108	Get Block Mode Memory 3
1032	108	Get Block Mode Memory 4
1140	108	Get Block Mode Memory 5
1248	108	Get Block Mode Memory 6
1356	108	Get Block Mode Memory 7
1464	108	Get Block Mode Memory 8
1572	108	Get Block Mode Memory 9
1680	108	Get Block Mode Memory 10
1788	108	Get Block Mode Memory 11
1896	108	Get Block Mode Memory 12
2004	108	Get Block Mode Memory 13
2112	108	Get Block Mode Memory 14
2220	108	Get Block Mode Memory 15
2328	108	Get Block Mode Memory 16

4.2.4.2 Address 0 - Vendor Information

In the vendor information the vendor name is stored and returned.

Function	Input Register (FUNCTION 04)
Address	0

Length	33
--------	----

Address	Parameter Description	Data Type
0 - 32	Vendor Name	STRING[65]

4.2.4.3 Address 40 - Device Information

The device information contains the product id, the sensor type and the serial number.

Function	Input Register (FUNCTION 04)
Address	40
Length	45

Address	Parameter Description	Data Type
40 -43	Product ID	STRING[9]
44	High Byte: Product ID / Low Byte: Sensor Type	STRING[65]
45 - 46	Sensor Type	
77 - 84	Serial Number	STRING[16]

4.2.4.4 Address 90 - Frontend Version

Returns the version of the website (frontend).

Function	Input Register (FUNCTION 04)
Address	90
Length	5

Address	Parameter Description	Data Type
90 - 94	Front-End Version	STRING[9]

4.2.4.5 Address 100 - Read Eth Config

The Ethernet configuration contains the IP address, subnet mask and gateway address.

Function	Input Register (FUNCTION 04)
Address	100
Length	6

Address	Parameter Description	Data Type
100 - 101	IP Address	uint32_t

102 – 103	Subnet Mask	uint32_t
104 - 105	Gateway Address	uint32_t

4.2.4.6 Address 120 - MAC Address

It contains the MAC address itself.

Function	Input Register (FUNCTION 04)
Address	120
Length	6

Address	Parameter Description	Data Type
120	Byte 0	uint16_t
121	Byte 1	uint16_t
122	Byte 2	uint16_t
123	Byte 3	uint16_t
124	Byte 4	uint16_t
125	Byte 5	uint16_t

4.2.4.7 Address 150 - Get Field of View Limits

Returns the measurement range limits.

Function	Input Register
Address	150
Length	12

Address	Parameter Description	Data Type
150 – 151	Minimum Left Limit [mm]	float32_t
152 – 153	Maximum Right Limit [mm]	float32_t
154 – 155	Minimum Width [mm]	float32_t
156 – 157	Minimum Distance	float32_t
158 – 159	Maximum Distance	float32_t
160 – 161	Minimum Height	float32_t

4.2.4.8 Address 200 - Get All Measurements

This command returns all measured and calculated values within one cycle inclusive the trigger time stamp.

Function	Input Register (04)
Address	200
Length	17

Address	Parameter Description	Data Type
200	Status	uint16_t
201	Quality	uint8_t
202	SwitchOut OR AlarmOut: SwitchOut -> 0x0001 AlarmOut -> 0x0002 0: Nothing 1: Switch Out 2: Alarm Out 3: Switch and Alarm Out	uint16_t
203 – 204	Average [mm]	float32_t
205 – 206	Max[mm]	float32_t
207 – 208	Min[mm]	float32_t
209 – 210	Standard Deviation	float32_t
211 – 212	Measurement Rate [Hz]	float32
213 – 214	Time Stamp [sec]	uint32_t
215 – 216	Time Stamp [usec]	uint32_t

4.2.4.9 Address 250 - Get Teachable Range

Returns the min/max range which the switch points can be set to.

Function	Input Register (FUNCTION 04)
Address	250
Length	14

Address	Parameter Description	Data Type
250 – 251	Minimum SP1	float32_t
252 – 253	Maximum SP1	float32_t
254 – 255	Minimum SP2	float32_t
256 – 257	Maximum SP2	float32_t
258 – 259	Minimum Hysteresis [mm]	float32_t

260 – 261	Maximum Hysteresis [mm]	float32_t
262 – 263	Minimum Distance between Switch Points	float32_t

4.2.4.10 Address 300 - Live Monitor

Returns the rotation angle and the distance from the sensor. The data is only available if the sensor is in the configuration mode.

Function	Input Register (FUNCTION 04)
Address	300
Length	4

Address	Parameter Description	Data Type
300 - 301	Rotation angle [deg]	float32_t
302 - 303	Distance [mm]	float32_t

4.2.4.11 Address 400 - Unsaved Config

Indicates if the sensor runs with a configuration which is not stored in any setting.

Function	Input Register (FUNCTION 04)
Address	400
Length	1

4.2.4.12 Address 401 - Active Setting Number

Returns the number of the active setting. The available settings number are 1-3.

Function	Input Register (FUNCTION 04)
Address	401
Length	1

4.2.4.13 Address 410 - Get Setting 1

The sensor supports three settings (1,2,3) which holds an entire configuration. These settings can be stored, loaded and reset.

Function	Input Register
Address	410
Length	25

Address	Parameter Description	Data Type
410 – 411	Trigger Mode	int32_t

412 – 413	Fixed Trigger Time [us]	uint32_t
414	Exposure Time	uint16_t
415	Precision	uint16_t
416 – 417	Range Left [mm]	float32_t
418 – 419	Range Right [mm]	float32_t
420 – 421	Distance Near[mm]	float32_t
422 – 423	Distance Far [mm]	float32_t
424 – 425	Switch Point 1 (SP1)	float32_t
426 – 426	Switch Point 2 (SP2)	float32_t
428 – 429	Switch Mode	int32_t
430 – 431	Hysteresis Width [mm]	float32_t
432 – 433	Digital Out Measurement Selector	int32_t
434	Polarity	uint16_t

4.2.4.14 Address 450 - Get Setting 2

The sensor supports three settings (1,2,3) which holds an entire configuration. These settings can be stored, loaded and reset.

Function	Input Register
Address	450
Length	25

Address	Parameter Description	Data Type
450 – 451	Trigger Mode	int32_t
452 – 453	Fixed Trigger Time [us]	uint32_t
454	Exposure Time	uint16_t
455	Precision	uint16_t
456 – 457	Range Left [mm]	float32_t
458 – 459	Range Right [mm]	float32_t
460 – 461	Distance Near[mm]	float32_t
462 – 463	Distance Far [mm]	float32_t
464 – 465	Switch Point 1 (SP1)	float32_t
466 – 466	Switch Point 2 (SP2)	float32_t

468 – 469	Switch Mode	int32_t
470 – 471	Hysteresis Width [mm]	float32_t
472 – 473	Digital Out Measurement Selector	int32_t
474	Polarity	uint16_t

4.2.4.15 Address 490 - Get Setting 3

The sensor supports three settings (1,2,3) which holds an entire configuration. These settings can be stored, loaded and reset.

Function	Input Register
Address	490
Length	25

Address	Parameter Description	Data Type
490 – 491	Trigger Mode	int32_t
492 – 493	Fixed Trigger Time [us]	uint32_t
494	Exposure Time	uint16_t
495	Precision	uint16_t
496 – 497	Range Left [mm]	float32_t
498 – 499	Range Right [mm]	float32_t
500 – 501	Distance Near[mm]	float32_t
502 – 503	Distance Far [mm]	float32_t
504 – 505	Switch Point 1 (SP1)	float32_t
506 – 506	Switch Point 2 (SP2)	float32_t
508 – 509	Switch Mode	int32_t
510 – 511	Hysteresis Width [mm]	float32_t
512 – 513	Digital Out Measurement Selector	int32_t
514	Polarity	uint16_t

4.2.4.16 Address 600-2436 - Get Block Mode Memory

To enable all measurement values to be retrieved in full with the maximum measurement rate, all measurement values are stored in a buffer containing up to 100 entries. When accessing the input register with address 600, the content of the buffer is copied to the Modbus TCP output buffer. From here, the content can then be retrieved sequentially in multiple sub-blocks. Each sub-block contains six measurement values.

Function	Input Register
Address	600, 708, 816, 924, 1032, 1140, 1248, 1356, 1464, 1572, 1680, 1788, 1896, 2004, 2112, 2220, 2328
Length	108

Address Offset	Parameter Description	Data Type
0	Quality	uint8_t
1	SwitchOut OR AlarmOut: SwitchOut -> 0x0001 AlarmOut -> 0x0002 0: Nothing 1: Switch Out 2: Alarm Out 3: Switch and Alarm Out	uint16_t
2 – 3	Average [mm]	float32_t
4 – 5	Max[mm]	float32_t
6 – 7	Min[mm]	float32_t
8 – 9	Standard Deviation	float32_t
10 – 11	Measurement Rate [Hz]	float32_t
12 – 13	Time Stamp [sec]	uint32_t
14 – 15	Time Stamp [usec]	uint32_t
16 - 17	Reserved	

4.3 OPC UA

OPC UA is a mature and convenient protocol which was specially developed to meet automation technology requirements. The client functionality required is already partially supported by programmable logic controllers. Various software libraries are available for PC-based systems. Further information is available on the website of the OPC Foundation (<https://opcfoundation.org>). An example of how a freely available OPC UA client can be used is described below.

4.3.1 Commissioning with the UaExpert OPC UA Client

The UaExpert software described can be acquired from <https://www.unified-automation.com/downloads/opc-ua-clients.html> once you have logged into the site.

4.3.1.1 Interface

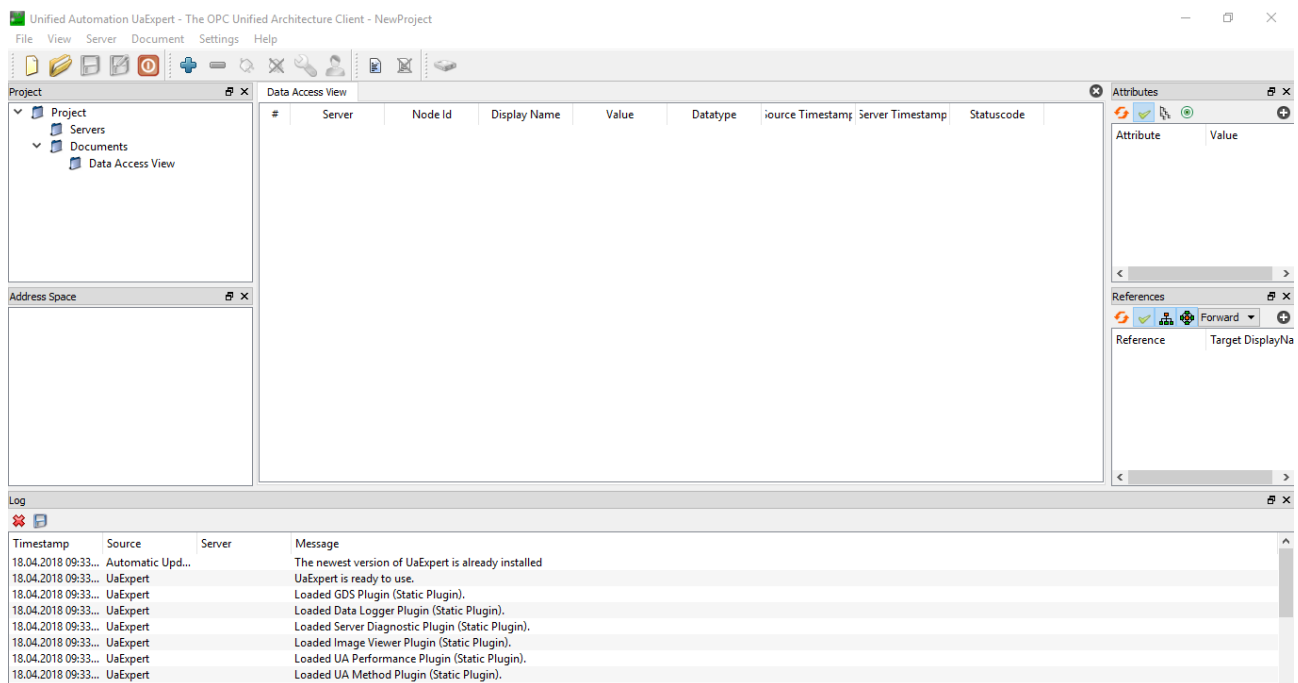

4.3.1.2 Adding a sensor

Click "Add Server".



Expand "Custom Discovery" and select "<Double click to Add Server...>"

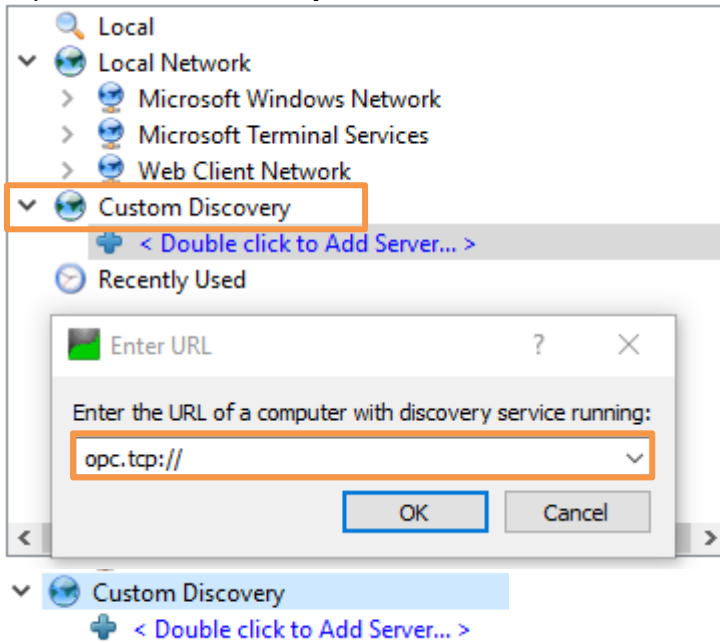

Enter the IP address of the sensor here and click OK to confirm.

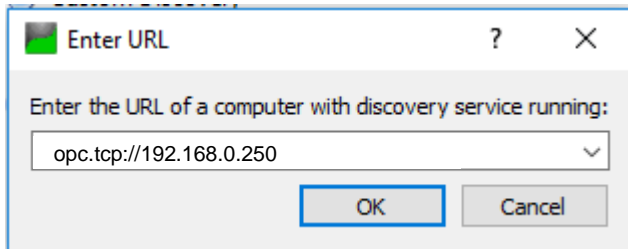

The sensor appears with the IP address. Click OK to confirm.

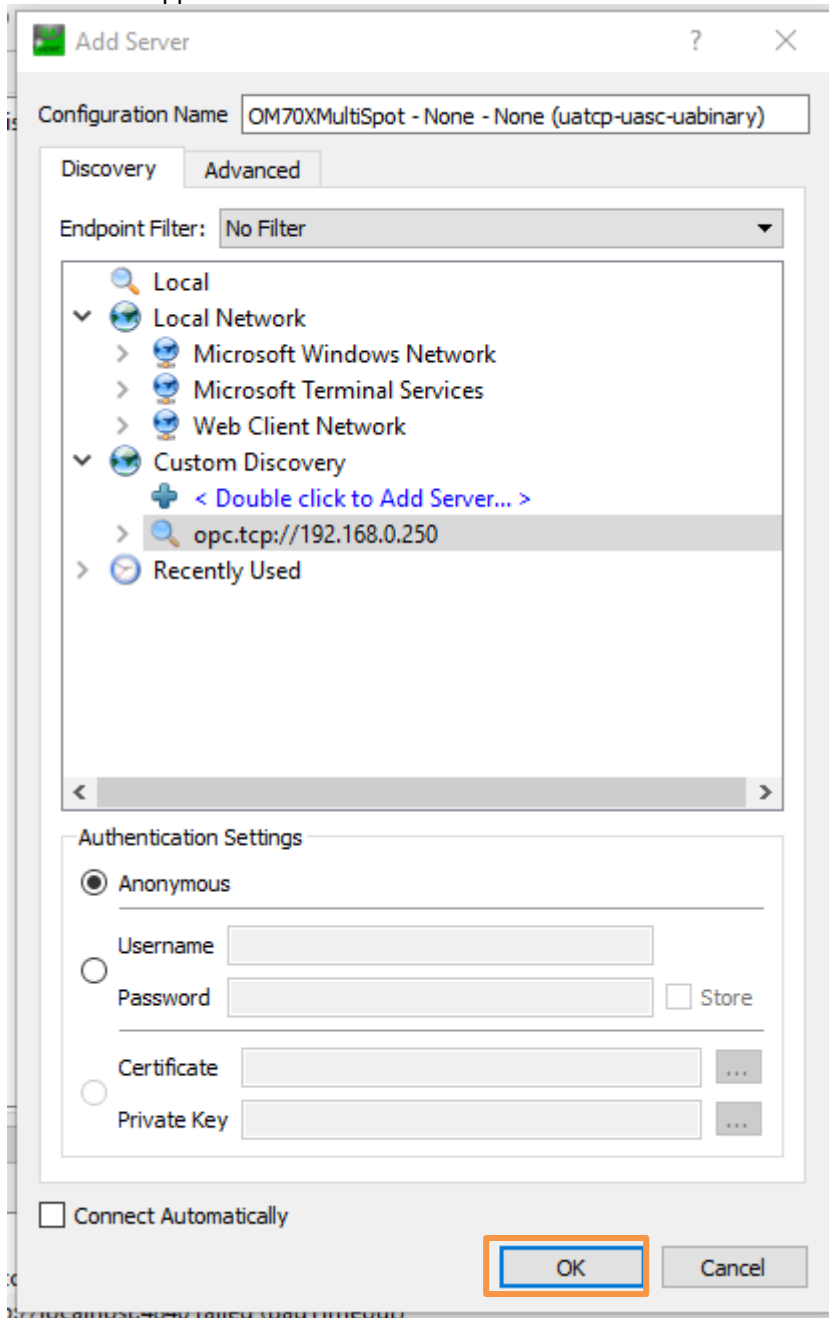



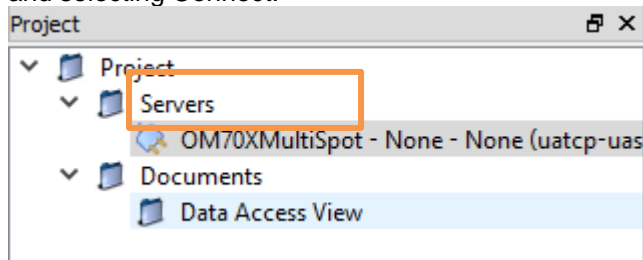

The sensor now appears in the top left-hand window under "Project" and can be connected by right-clicking and selecting Connect.

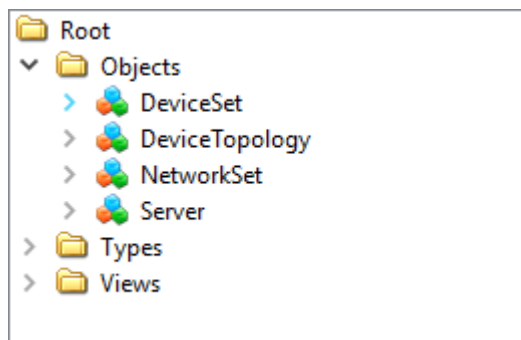

The sensor is now connected and can be used. The function tree was read from the sensor and is displayed in the left-hand window under "Address Space".



4.3.1.3 Explanation of symbols

-  = Nodal point
-  = Variable node (partly read/write)
-  = Variable node (property)
-  = Method node = action with call

4.3.1.4 Making settings

As soon as InitLock has been activated, settings can be made on the sensor.

Example: The precision should be set to Standard (measurement without filtering):

ActiveParameterSetup→Precision

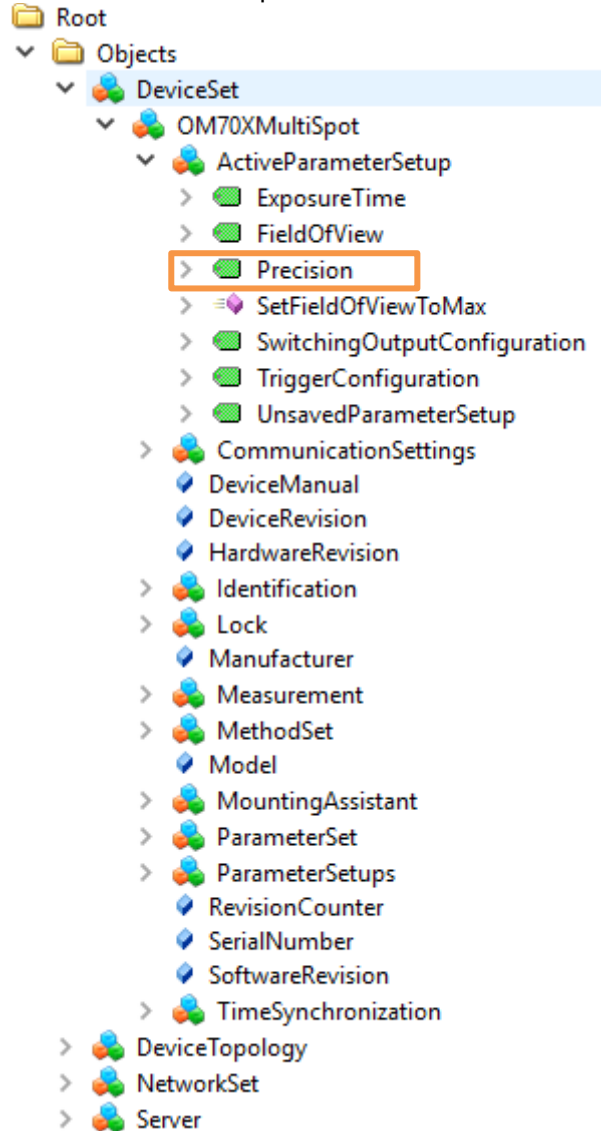

The value can now be set under "Value".
Double-click on this and change.

Attribute	Value
▼ Nodeld	Nodeld
NamespaceIndex	3
IdentifierType	Numeric
Identifier	90
NodeClass	Variable
BrowseName	3, "Precision"
DisplayName	"" , "Precision"
Description	"" , ""
WriteMask	BadAttributeInvalid (0x80350)
UserWriteMask	BadAttributeInvalid (0x80350)
▼ Value	
SourceTimestamp	13.06.2018 15:46:00.672
SourcePicoseconds	0
ServerTimestamp	13.06.2018 15:46:00.672
ServerPicoseconds	0
StatusCode	Good (0x00000000)
Value	0 (Standard)
▼ DataType	Precision
NamespaceIndex	3
IdentifierType	Numeric
Identifier	8
ValueRank	-1
ArrayDimensions	BadAttributeInvalid (0x80350)
AccessLevel	CurrentRead, CurrentWrite
UserAccessLevel	CurrentRead, CurrentWrite
MinimumSamplingInterval	0
Historizing	false

Doppelklick und per Drop-Down anpassen

4.3.1.5 Reading measurement values

Under Measurement→MeasurementValues

Click on the required measurement value here, e.g., Average.

- ▼ Measurement
 - ▼ MeasurementValues
 - > AlarmOutput
 - > Average
 - > ConfigModeActive
 - > Max
 - > MeasurementRate
 - > Min
 - > Quality
 - > StandardDeviation
 - > SwitchingOutput
 - > TimelsSynchronized
 - > MeasurementValuesBlock

The "Attribute" window on the right outputs all relevant values for this property.
 The measurement value is found under "Value". Clicking "Refresh" updates the measurement value.

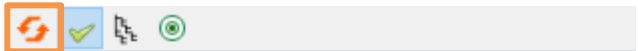

Attribute	Value
▼ Nodeld	Nodeld
NamespaceIndex	3
IdentifierType	Numeric
Identifier	280
NodeClass	Variable
BrowseName	3, "Average"
DisplayName	"" , "Average"
Description	"" , ""
WriteMask	BadAttributeIdInvalid (0x80)
UserWriteMask	BadAttributeIdInvalid (0x80)
▼ Value	
SourceTimestamp	01.01.1970 08:35:01.129
SourcePicoseconds	0
ServerTimestamp	13.06.2018 15:49:11.192
ServerPicoseconds	0
StatusCode	Good (0x00000000)
Value	125.935
▼ DataType	Float

4.3.2 Structure and description of the OPC UA commands

4.3.2.1 Sensor function tree

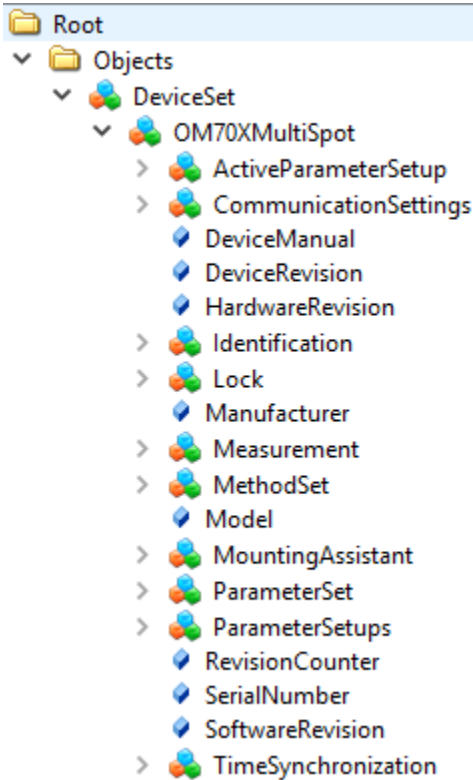

4.3.2.2 Unlocking

In order to configure the sensor, this must be unlocked using a command.

Right-click on "InitLock" and then execute with "Call".

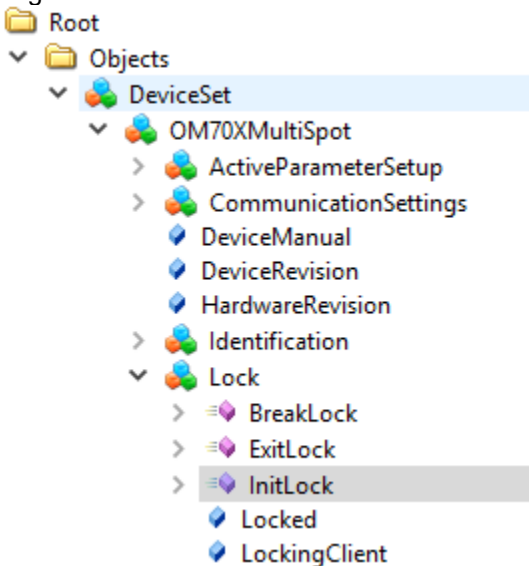

Click "Call" again to unlock the sensor.

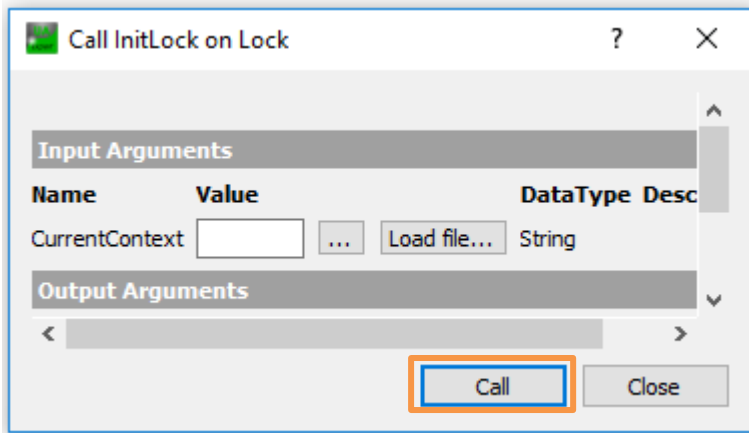

Settings can now be made (write).

4.3.2.3 ActiveParameterSetup



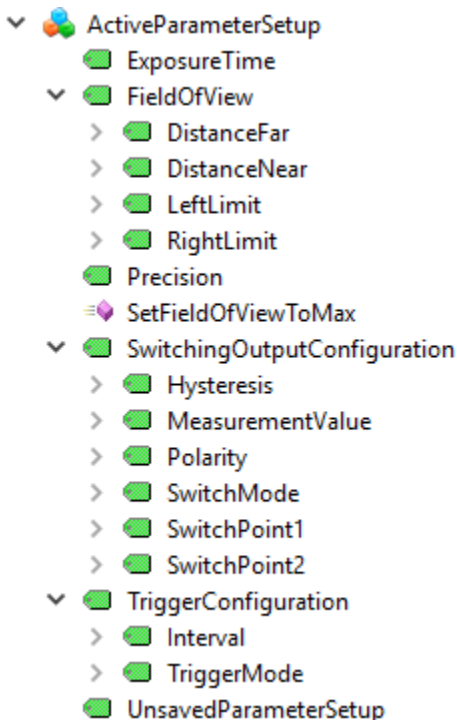





















Output of the active sensor parameters.



OPC UA command	Explanation
ExposureTime	Exposure time: light/dark object
FieldOfView	Field of view limits: field of view height, offset, left limit, right limit
Precision	Precision filtering. Settings: standard, high, very high
SetFieldOfViewToMax	Reset field of view to maximum values
SwitchingOutputConfiguration	Make settings for the switching output: hysteresis, polarity, threshold/window, set switching points
TriggerConfiguration	For setting the measuring intervals. Free running, single shot, or interval
UnsavedParameterSetup	True if the currently active configuration has not yet been saved in nonvolatile (permanent) memory



4.3.2.4 CommunicationSettings

Output of the communication settings.

-  CommunicationSettings
 -  Ethernet
 -  MacAddress
 -  >
 -  Ip
 -  IpAddress
 -  >
 -  SetIpParameters
 -  >
 -  StandardGateway
 -  >
 -  SubnetMask
 -  >
 -  UseDhcp
 -  >
 -  ModbusTCP
 -  ModbusActive
 -  >
 -  DeviceManual
 -  >
 -  DeviceRevision
 -  >
 -  HardwareRevision
 -  >

















OPC UA command	Sensor command
Ethernet	Output of MAC address
Ip	Output and modification of IP address, gateway, subnet mask, and DHCP server.
ModbusTCP	Switching on/off the Modbus interface by setting 0=Off or 1=On

4.3.2.5 Identification

-  Identification
 -  ProductId
 -  >

OPC UA command	Sensor command
ProductId	Output of the article/order number of the sensor













4.3.2.6 Lock

-  Lock
 -  BreakLock
 -  >
 -  ExitLock
 -  >
 -  InitLock
 -  >
 -  Locked
 -  >
 -  LockingClient
 -  >
 -  LockingUser
 -  >
 -  RemainingLockTime
 -  >
 -  RenewLock
 -  >

OPC UA command	Sensor command
BreakLock	Not implemented
ExitLock	Leave Configuration mode
InitLock	Set sensor to Configuration mode, enabling settings to be changed
Locked	Specifies whether the sensor is currently in Configuration mode
LockingClient	Specify which interface was used to set the sensor to Configuration mode
LockingUser	Not implemented
RemainingLockTime	Not implemented
RenewLock	Not implemented

4.3.2.7 Measurement









Output of the sensor measurement values.

- ▼  Measurement
 - ▼  MeasurementValues
 - >  AlarmOutput
 - >  Average
 - >  ConfigModeActive
 - >  Max
 - >  MeasurementRate
 - >  Min
 - >  Quality
 - >  StandardDeviation
 - >  SwitchingOutput
 - >  TimelsSynchronized
 - >  MeasurementValuesBlock

OPC UA command	Sensor command																										
AlarmOutput	Output of alarm output – active yes/no																										
Average	Output of the average																										
ConfigModeActive	The measurement value was determined when the sensor was in Configuration mode																										
Delta	Output of the delta value																										
Max	Output of the maximum value																										
MeasurementRate	Output of the measurement rate in Hz																										
Min	Output of the minimum value																										
Quality	Output of the signal quality 0 = Valid signal, 1 = Low signal, 2 = No signal																										
StandardDeviation	Output of the standard deviation																										
SwitchingOutput	Output of switching output – active yes/no																										
TimelsSynchronized	The time stamp of the measurement is based on the time synchronized via NTP																										
MeasurementValuesBlock	The last 100 measurement values are saved with a time stamp and can be retrieved if necessary. When new measurement values are saved, the oldest measurement value is deleted first. <table border="1" style="margin-top: 10px;"> <tbody> <tr> <td>[0]</td> <td>MeasurementValuesBlockType</td> </tr> <tr> <td>Quality</td> <td>0 (ValidSignal)</td> </tr> <tr> <td>SwitchingOut...</td> <td>true</td> </tr> <tr> <td>AlarmOutput</td> <td>true</td> </tr> <tr> <td>Average</td> <td>10.766</td> </tr> <tr> <td>Max</td> <td>12.085</td> </tr> <tr> <td>Min</td> <td>9.63067</td> </tr> <tr> <td>Delta</td> <td>2.45433</td> </tr> <tr> <td>StandardDevi...</td> <td>0.652816</td> </tr> <tr> <td>Measuremen...</td> <td>157.853</td> </tr> <tr> <td>TimeStamp</td> <td>1970-01-01T03:43:24.078Z</td> </tr> <tr> <td>[1]</td> <td>MeasurementValuesBlockType</td> </tr> <tr> <td>[2]</td> <td>MeasurementValuesBlockType</td> </tr> </tbody> </table>	[0]	MeasurementValuesBlockType	Quality	0 (ValidSignal)	SwitchingOut...	true	AlarmOutput	true	Average	10.766	Max	12.085	Min	9.63067	Delta	2.45433	StandardDevi...	0.652816	Measuremen...	157.853	TimeStamp	1970-01-01T03:43:24.078Z	[1]	MeasurementValuesBlockType	[2]	MeasurementValuesBlockType
[0]	MeasurementValuesBlockType																										
Quality	0 (ValidSignal)																										
SwitchingOut...	true																										
AlarmOutput	true																										
Average	10.766																										
Max	12.085																										
Min	9.63067																										
Delta	2.45433																										
StandardDevi...	0.652816																										
Measuremen...	157.853																										
TimeStamp	1970-01-01T03:43:24.078Z																										
[1]	MeasurementValuesBlockType																										
[2]	MeasurementValuesBlockType																										

4.3.2.8 MethodSet



List of all methods made available by the sensor

- ▼  **MethodSet**
 - >  FactoryReset
 - >  LoadParameterSetup
 - >  ResetParameterSetup
 - >  SetFieldOfViewToMax
 - >  SetIpParameters
 - >  StoreParameterSetup
 -  Model

OPC UA command	Sensor command
FactoryReset	Reset the factory settings
LoadParameterSetup	Load stored parameter setup 1-3. The value 1-3 must be specified
ResetParameterSetup	Delete stored parameter setup 1-3. The value 1-3 must be specified
SetFieldOfViewToMax	Reset the field of view to the maximum value
SetIpParameters	Modify IP address, subnet mask, and standard gateway
StoreParameterSetup	Store active parameters in parameter setup 1-3. The value 1-3 must be specified
Model	Output of the model name

4.3.2.9 MountingAssistant

Check of the installation conditions.

- ▼  **MountingAssistant**
 -  LaserOn
 - >  MountingPosition

OPC UA command	Sensor command
LaserOn	Switch laser on/off
MountingPosition	Output of the current mounting angle and the distance to the reference surface. These values can only be read if the sensor is in Configuration mode







4.3.2.10 ParameterSet

Summary of all sensor parameters. These can be displayed or set here.

ParameterSet	OPC UA command	Sensor command
> ActiveParameterSetupNumber	ActiveParameterSetupNumber	Specifies which parameter setup was loaded most recently and which will be reloaded following an interruption to the power supply
> ExposureTime	ExposureTime	Exposure time: light/dark object
> FieldOfView	FieldOfView	Values for field of view
> IpAddress	IpAddress	IP address
> LaserOn	LaserOn	Laser on/off
> MacAddress	MacAddress	MAC address
> MeasurementValues	MeasurementValues	Output of all current measurement values
> MeasurementValuesBlock	MeasurementValuesBlock	Output of the last 100 measurement values
> ModbusActive	ModbusActive	Modbus on/off
> MountingPosition	MountingPosition	Mounting assistant: current mounting angle and distance to the reference surface
> NtpServer1	NtpServer1	IP address for NTP (Network Time Protocol) server 1
> NtpServer2	NtpServer2	IP address for NTP (Network Time Protocol) server 2
> ParameterSetup1	ParameterSetup1	Parameter setup 1
> ParameterSetup2	ParameterSetup2	Parameter setup 2
> ParameterSetup3	ParameterSetup3	Parameter setup 3
> Precision	Precision	Standard/high/very high precision
> ProductId	ProductId	Article/order number
> StandardGateway	StandardGateway	Standard gateway
> SubnetMask	SubnetMask	Subnet mask
> SwitchingOutputConfiguration	SwitchingOutputConfiguration	Switching points and hysteresis
> TimeSyncMode	TimeSyncMode	Internal or NTP time synchronization
> TriggerConfiguration	TriggerConfiguration	Trigger mode: free running, single shot, or interval
> UnsavedParameterSetup	UnsavedParameterSetup	True if the currently active configuration has not yet been saved in nonvolatile (permanent) memory
> UseDhcp	UseDhcp	Use DHCP (Dynamic Host Configuration Protocol)

4.3.2.11 ParameterSetups





The parameter setups stored on the sensor can be displayed or loaded here.

- ▼  **ParameterSetups**
- >  **ActiveParameterSetupNumber**
- >  **LoadParameterSetup**
- >  **ResetParameterSetup**
- >  **StoreParameterSetup**
- >  **StoredParameterSetups**
- >  **UnsavedParameterSetup**

OPC UA command	Sensor command
ActiveParameterSetupNumber	Number of the active parameter setup 1-3
LoadParameterSetup	Load the stored parameter setup 1-3. The value 1-3 must be specified
ResetParameterSetup	Delete stored parameter setup 1-3. The value 1-3 must be specified
StoreParameterSetup	Store active parameters under parameter setup memory location 1-3. The value 1-3 must be specified
StoredParameterSetups	Display or adjust parameter setups 1-3
UnsavedParameterSetup	True if the currently active configuration has not yet been saved in nonvolatile (permanent) memory

4.3.2.12 TimeSynchronization

Settings for time synchronization

- ▼  **TimeSynchronization**
- >  **NtpServer1**
- >  **NtpServer2**
- >  **TimeSyncMode**

OPC UA command	Sensor command
NtpServer1	IP address for NTP (Network Time Protocol) server 1
NtpServer2	IP address for NTP (Network Time Protocol) server 2
TimeSyncMode	Internal or NTP time synchronization

5 Operation

5.1 Status displays on the sensor

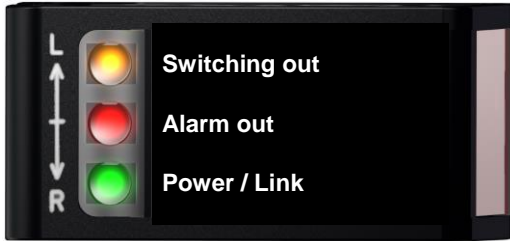

LED	Lights up	Flashes
Yellow	Switching out Switching output (out 1) active	-
Red	Alarm out Alarm output (out 2) active. No measuring object within the field of view or signal quality is inadequate	Signal gain Object close to signal gain or signal quality not ideal
Green	Power Sensor ready for operation, Ethernet connection not available	Short circuit Check connection at switching or alarm output
Blue	Link Ethernet connection established	Data transmission Data packets are sent and received via Ethernet

5.2 Measuring frequency, measuring repeat time, and response time

A complete measurement cycle consists of exposure, calculation, and measuring value display. In order to increase the measuring speed, process steps are executed simultaneously.

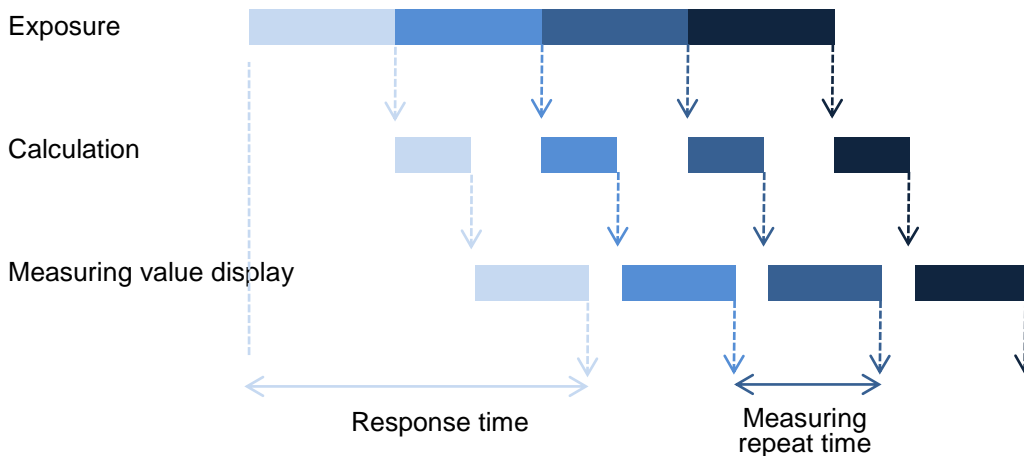

5.2.1 Measuring frequency and measuring repeat time

The time between two exposure times is referred to as measuring repeat time. This time can be converted into a frequency (Hz), which indicates how many measurement values can be issued by the sensor in one second.

$$\text{Messfrequenz [kHz]} = 1 / \text{Messwiederholzeit [ms]}$$

5.2.2 Automatic exposure control

The color and surface of the object have an influence on the amount of reflected light. A longer exposure time is required for dark objects than for light objects. The sensor automatically controls the exposure time on the basis of the amount of light reflected by the object. This slows down the measuring frequency and the response time. In this case, the degree of slowdown is dependent on the laser class of the sensor.

5.3 Alarm output

The alarm signal is output as a push-pull signal (active high). It is set when the object is outside the measuring range or the signal quality is insufficient for evaluation. If the signal quality is insufficient, the analog and switching outputs for 75 measurement cycles are kept at the last valid value. After this time has elapsed, the analog and switching outputs are set as if an object were at the start of the measuring range.

NOTE



As soon as the alarm output is active, the analog and switching outputs for 75 measurement cycles are kept at the last valid value.

5.4 Object to be measured

5.4.1 Smallest detectable object

For an object to be reliably detected, it must conform to the minimum object width¹. This minimum object width varies with the distance from the sensor.

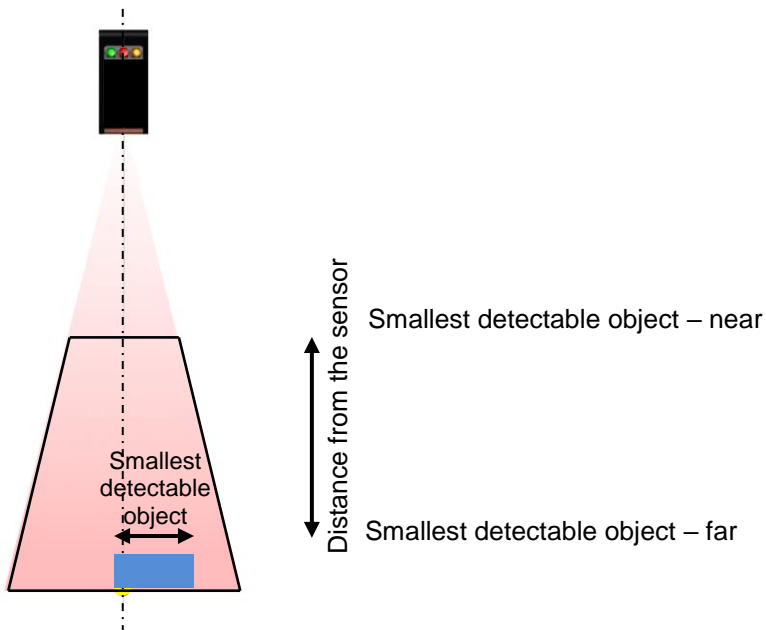

5.4.2 Reflectivity

Light objects are generally easier to detect than dark objects, since they are more reflective. Reflectivity is the percentage relationship between incident and reflected light.

Definition of objects:

Object white	approx. 90% reflectivity
Object black	approx. 6% reflectivity
Object light	> 18% reflectivity
Object dark	6...18% reflectivity

5.4.3 Standard object

The technical data for sensors in the data sheet refers to measurements with a Baumer standard object. This standard object is precisely defined in size, shape, and color, making multiple measurements comparable.

Standard object definition:

- Ceramics white (reflectivity approx. 90%)
- Smooth, flat surface
- Covers entire sensor measuring range

¹ In accordance with chapter Sensor data sheet

5.5 Memory

All changes stored in a parameter setup are saved in nonvolatile (permanent) memory and are even retained after a power outage.

5.6 Error correction and tips

Error	Error correction
No function	<ul style="list-style-type: none"> • Check connection. Power supply 15...28 VDC on pin 2 (+Vs, brown) and pin 7 (GND, blue)
Green LED flashes	<ul style="list-style-type: none"> • Short circuit on switching outputs. Check connection
Red LED lights up	<ul style="list-style-type: none"> • Object outside field of view (near, far, or to the side) • Amplitude of the received signal is insufficient (e.g., in case of soiling)
Sensor does not provide the expected measuring results	<ul style="list-style-type: none"> • Check inclination angle • The object is not in the measuring range • Bright object, avoid direct reflexes from the transmitter to the receiver
The sensor does not take account of all objects within the field of view	<ul style="list-style-type: none"> • Enlarge field of view. The field of view was possibly limited; see Section "FIELD OF VIEW" • The red visible laser beam does not represent the maximum field of view. If the object is at the edge of this beam it could be outside the measuring range • Move object. The object is outside the field of view vertically or is in the blind region of the sensor
Unreliable measurement value: The measurement value jumps back and forth	<ul style="list-style-type: none"> • The object is not in the measuring range • Avoid bright object • Avoid very dark object • Too much ambient light • Check measurement mode setting (MEASUREMENT MODE)
Transmitting laser light is dim	Sync-In input is on High--> set to Low
Incorrect measurement values	This is probably due to a malfunction caused by ambient light. Attempts should be made to reduce the ambient light
A communication error occurs during changing the IP address	If the IP address is changed, it must be reconnected to the sensor
No tool status message during an error	A tool status message only states that the communication with the sensor that was initiated by the call was successful. If there are problems, this is returned by the sensor as an error code

6 Safety instructions and maintenance

6.1 General safety instructions

Intended use

This product is a precision device and is used for object detection and the preparation and/or provision of measurement values as electrical quantities for a subsequent system. Unless this product is specially labeled, it may not be used for operation in potentially explosive environments.

Commissioning

Installation, mounting, and adjustment of this product may only be performed by a qualified person.

Installation

For mounting, use only the mechanical mountings and mechanical mounting accessories intended for this product. Unused outputs must not be wired. In cable versions with unused cores, these cores must be insulated. Always comply with admissible cable bending radii. Prior to electrical connection of the product, the system must be disconnected from the power supply. In areas where shielded cables are mandatory, they must be used as protection against electromagnetic disturbances. If the customer makes plug connections to shielded cables, an EMC version of the connectors should be used, and the shield must be connected to the connector housing across a large area.

Caution

Deviation from the procedures and settings specified here can lead to hazardous radiation effects.

6.2 Sensor inscriptions

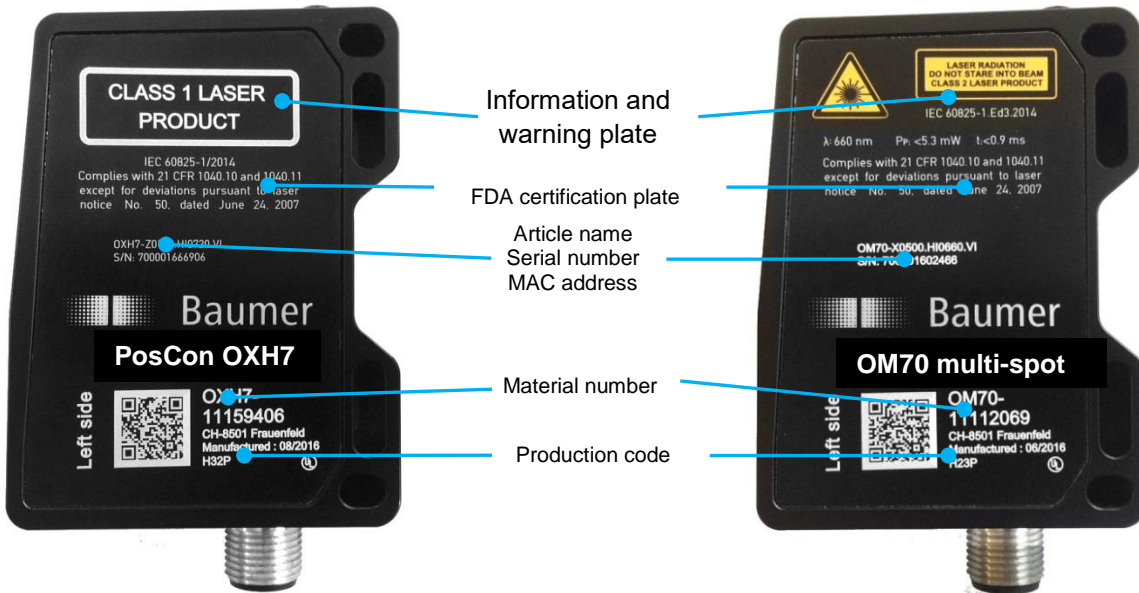

Information and warning plate	<p>Class 1: No risk for eyes or skin</p> <div style="border: 2px solid black; padding: 10px; width: fit-content; margin: 0 auto;"> <p>CLASS 1 LASER PRODUCT</p> </div> <p>Class 1 lasers are safe under reasonably foreseeable operational conditions of normal use, including direct long-term viewing of the beam, even when exposure occurs using a magnifying optic.</p>	<p>Class 2: Do not stare into the beam</p> <div style="border: 2px solid black; padding: 10px; width: fit-content; margin: 0 auto;"> <p style="text-align: center;">LASER RADIATION DO NOT STARE INTO BEAM Wavelength: 640...670nm IEC 60825-1, Ed. 3, 2014 CLASS 2 LASER PRODUCT</p> </div> <p>Accidental short-term exposure (up to 0.25 s) does not damage the eye, because the corneal reflex can automatically protect the eye sufficiently from longer radiation. Class 2 lasers may be used without any further protection if intentional staring into the beam is not required for the application.</p>
	FDA certification plate	<p>IEC 60825-1/2014 Complies with 21 CFR 1040.10 and 1040.11 except for conformance with IEC 60825-1 Ed. 3., as described in Laser Notice No. 56, dated May 8, 2019</p>

6.3 Front optic

In the event of a broken front optic, defective display, or loose or exposed laser lens, the sensor must be disconnected from the power supply immediately. It must not be put into operation again until it has been inspected by an authorized person. Non-compliance with these safety instructions may lead to the release of hazardous laser beams.

**ATTENTION!**

The use of a sensor with a broken front optic or loose or exposed lens can lead to hazardous laser radiation.

6.4 Cleaning the sensors

The laser distance sensors do not require any maintenance, except that the front windows must be kept clean. Dust and fingerprints can impair sensor function. It is normally sufficient to wipe the windows with a clean (!), soft lens cleaning cloth. Alcohol or soapy water can be used in case of severe soiling. The display and the keys must be kept free from dirt and moisture. Water and dirt on the keys can impair their function.

**ATTENTION!**

Protect optical surfaces from moisture and dirt.

6.5 Disposal

This sensor contains electronic components. Dispose of parts according to country-specific provisions.

7 Sensor data sheet

General data	OM70 multi-spot 11185168 OM70-11185168
Function	Distance
Function: FIELD OF VIEW	Yes
Measuring range (distance)	100...150 mm
Start of measuring range Sdc	100
End of measuring range Sde	150
Measuring range (width)	48...72 mm
Field of view width right @ Sde	+36 mm
Field of view width left @ Sde	-36 mm
Blind region	0...100 mm
Measuring frequency - OBJECT light (approx. 90% refl.) - OBJECT dark (approx. 6% refl.)	244...570 Hz ¹³ 192...342 Hz ¹³
Response time - OBJECT light (approx. 90% refl.) - OBJECT dark (approx. 6% refl.)	3.5...8.2 ms ¹³ 5.8...10.4 ms ¹³
AVG DIST resolution (max. field of view width)	8...16 μm^{234} (without filter) 4...8 μm^{2345} (with precision = high filter) 2...4 μm^{2345} (with precision = very high filter)
MIN / MAX DIST resolution	23...48 μm^{23} (without filter) 12...24 μm^{235} (with precision = high filter) 6...12 μm^{235} (with precision = very high filter)
AVG DIST repeat accuracy (max. field of view width)	8 μm^{234} (without filter) 4 μm^{2345} (with precision = high filter) 2 μm^{2345} (with precision = very high filter)
MIN / MAX DIST repeat accuracy	16 μm^{23} (without filter) 8 μm^{235} (with precision = high filter) 4 μm^{235} (with precision = very high filter)
Linearity error	$\pm 20 \mu\text{m}^{2346}$
Temperature drift	$\pm 0.04\% \text{ Sde}/\text{K}^{234}$
PRECISION filter values: Standard High Very High	Median Average Off Off 3 Off 3 16
Smallest detectable object	0.7...1.1 mm
Laser class	1
Max. reference surface unevenness (rms)	$\pm 0.04 \text{ mm}$
Min. reference surface length	24 mm
Digital output hysteresis	Adjustable in mm
Minimum switching window	2 mm
Power on indication/data transmission	LED green/LED blue
Output indicator	Yellow LED / red LED
Light source	Red laser diode, pulsed
Setting	Web interface, Modbus TCP, OPC UA

¹ Measurement rate subject to measuring range (distance). Min. value: maximum field of view; max. value: 20% of field of view

² Measurements with standard Baumer measuring equipment and objects dependent on measuring range Sd

³ Measurement on 90% reflectivity (white)

⁴ Measurement with Average measurement mode

⁵ Measurement with filtering

⁶ Measuring range (distance) 100...112.5 mm

Electrical data	OM70 multi-spot 11185168 OM70-11185168
Voltage supply range +Vs	15 ... 28 VDC
Max. supply current (without load)	120 mA
Switching output	Push-pull
Switching function	Out 1 / alarm
Output current	< 100 mA
Baud rate	38,400 / 57,600 / 115,200
Reverse polarity protection	Yes, +Vs to GND
Short circuit protection	Yes

Mechanical data	OM70 multi-spot 11185168 OM70-11185168
Width / Height / Length	26 / 74 / 55 mm
Design	Rectangular, front view
Housing material	Aluminum
Front optic	Glass
Connection method	M12 8-pin & M12 4-pin plugs
Weight	134 g

Ambient conditions	OM70 multi-spot 11185168 OM70-11185168
Ambient light immunity	< 35 kLux
Operating temperature	-10 ... +50 °C
Storage temperature	-20 ... +60 °C
Protection class	IP 67
Vibration (sinusoidal)	IEC 60068-2-6:2008 7.5mm p-p for f = 2 - 8Hz 2g for f = 8 – 200Hz, or 4g for 200 – 500Hz IEC 60068-2-6:2008 1.5 mm p-p at f = 10 - 57 Hz, 10 cycles per axis 10 g at f = 58 - 2000 Hz, 10 cycles per axis
Resonance test	IEC 60068-2-6:2008 1.5mm p-p for f = 10 - 57Hz , 10 cycles for each axis 10g for f = 58 -2,000Hz, 10 cycles for each axis
Vibration resistance (random)	IEC 60068-2-64:2008 Spectrum: 0.1 g ² /Hz for 20 – 1,000Hz, 300 minutes / axis (>10gRMS)
Shock (semi-sinusoidal)	IEC 60068-2-27:2009 30 g / 11 ms, 6 jolts per axis and direction

Optical properties	OM70 multi-spot 11185168 OM70-11185168
Light source	AlGaInP laser diode
Wave length	656 nm
Operating mode	Pulsed
Pulse duration	
Light mode	0.6 ms
Dark mode	1.8 ms

Pulse period	
Light mode	> 1.7 ms
Dark mode	> 2.9 ms
Total emitted pulse power	3 mW
Beam shape	Elliptical (focused toward laser line)
Focal distance d_f	125 mm
Beam size at window	
Vertical	2.5 mm
Parallel	7.5 mm
Beam size at focal point	
Vertical	< 0.1 mm
Parallel	L = 73 mm
Beam divergence	
Vertical δ_{\perp}	16.0 mrad
Parallel δ_{\parallel}	30.2°
Nominal ocular hazard distance (NOHD) ¹	NA
Laser classification (as per IEC 60825-1/2014)	Laser class 1

¹ Outside the "Nominal ocular hazard distance", the radiation exposure is below the limit value of laser class 1

8 Revision history

06/15/2018	tof	Manual released in version 1.0
11/23/2018	stke	Correction ModbusTCP commands included in version 1.3



Baumer Group
International Sales
P.O. Box · Hummelstrasse 17 · CH-8501 Frauenfeld
Phone +41 (0)52 728 1122 · Fax +41 (0)52 728 1144
sales@baumer.com · www.baumer.com