

IGYX 12P17B1/S14L

Inductive proximity switch

Article number: 11230122

Overview

- 4 mm
- 3,2 mm
- PNP make function (NO)
- connector M12
- -25 ... 75 °C
- IP 67



Picture similar

Technical data

General data

Mounting type	Flush
Nominal sensing distance S _n	4 mm
Assured sensing distance S _a	3,2 mm
Temperature drift	± 10 % of S _r (0 ... +60 °C)
Hysteresis	3 ... 20 % of S _r
Output indicator	3 port LED red

Electrical data

Switching frequency	< 1,5 kHz
Voltage supply range +V _s	10 ... 30 VDC
Current consumption max. (no load)	15 mA
Output circuit	PNP make function (NO)
Voltage drop V _d	< 2,5 VDC

Electrical data

Output current	< 200 mA
Short circuit protection	Yes
Reverse polarity protection	Yes

Mechanical data

Type	Cylindrical threaded
Material (sensing face)	PBT, red
Housing material	Brass nickel plated
Dimension	12 mm
Housing length	60 mm
Connection types	Connector M12
Tightening torque max.	10 Nm

Ambient conditions

Operating temperature	-25 ... +75 °C
Protection class	IP 67

Remarks

- Compliant with EMC requirements of EN 60947-5-2: 2007

Dimension drawing

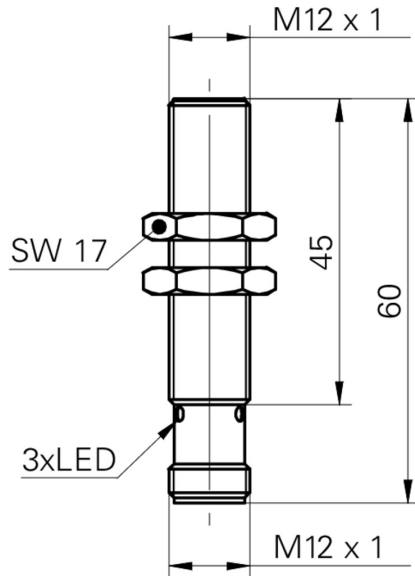

Connection diagram

