

Overview

- 2 mm
- 1,6 mm
- NPN make function (NO)
- connector M8
- -25 ... 75 °C
- IP 67



Picture similar

Technical data

General data

Mounting type	Flush
Nominal sensing distance S _n	2 mm
Assured sensing distance S _a	1,6 mm
Temperature drift	± 10 % of S _r (0 ... +60 °C)
Hysteresis	3 ... 20 % of S _r
Output indicator	3 port LED red

Electrical data

Switching frequency	< 3 kHz
Voltage supply range +V _s	10 ... 30 VDC
Current consumption max. (no load)	15 mA
Output circuit	NPN make function (NO)
Voltage drop V _d	< 2,5 VDC

Electrical data

Output current	< 200 mA
Short circuit protection	Yes
Reverse polarity protection	Yes

Mechanical data

Type	Cylindrical threaded
Material (sensing face)	PBT, red
Housing material	Stainless steel
Dimension	8 mm
Housing length	56 mm
Connection types	Connector M8
Tightening torque max.	5 Nm

Ambient conditions

Operating temperature	-25 ... +75 °C
Protection class	IP 67

Remarks

- Compliant with EMC requirements of EN 60947-5-2: 2007

Dimension drawing

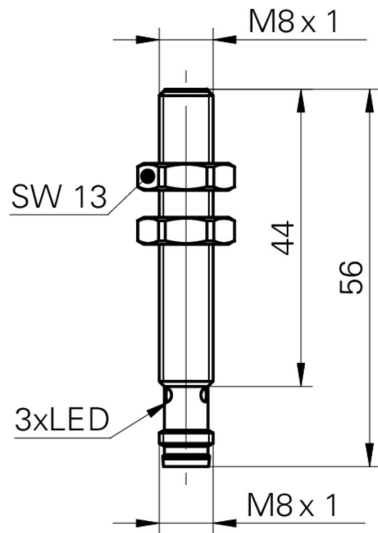

Connection diagram

