

# CFDK 25G3125/LN3

Näherungsschalter

Proximity sensor

Détecteur de proximité



11092584



## Baumer

Baumer Electric AG · CH-8501 Frauenfeld  
Phone +41 (0)52 728 1122 · Fax +41 (0)52 728 1144

### Abmessungen Dimensions Dimensions

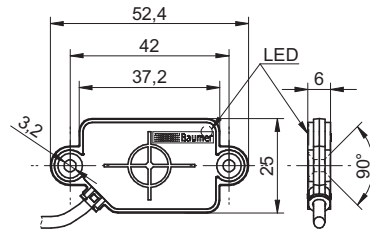

- Alle Masse in mm
- All dimension in mm
- Toutes les dimensions en mm

### Elektrischer Anschluss Connection diagram Schéma de raccordement

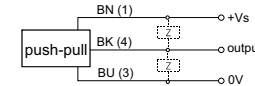

BN = Braun/brown/brun  
BK = Schwarz/black/noir  
BU = Blau/blue/bleu

- Vor dem Anschliessen des Sensors die Anlage spannungsfrei schalten.
- Disconnect power before connecting the sensor.
- Mettre l'installation hors tension avant le raccordement du détecteur.

**Canada**  
Baumer Inc.  
CA-Burlington, ON L7M 4B9  
Phone +1 (1)905 335-8444

**Italy**  
Baumer Italia S.r.l.  
IT-20090 Assago, MI  
Phone +39 (0)2 45 70 60 65

**China**  
Baumer (China) Co., Ltd.  
CN-201612 Shanghai  
Phone +86 (0)21 6768 7095

**Singapore**  
Baumer (Singapore) Pte. Ltd.  
SG-339412 Singapore  
Phone +65 6396 4131

**Denmark**  
Baumer A/S  
DK-8210 Aarhus V  
Phone: +45 (0)8931 7611

**Sweden**  
Baumer A/S  
SE-56133 Huskvarna  
Phone +46 (0)36 13 94 30

**France**  
Baumer SAS  
FR-74250 Fillinges  
Phone +33 (0)450 392 466

**Switzerland**  
Baumer Electric AG  
CH-8501 Frauenfeld  
Phone +41 (0)52 728 1313

**Germany**  
Baumer GmbH  
DE-61169 Friedberg  
Phone +49 (0)6031 60 07 0

**United Kingdom**  
Baumer Ltd.  
GB-Watchfield, Swindon, SN6 8TZ  
Phone +44 (0)1793 783 839

**India**  
Baumer India Private Limited  
IN-411058 Pune  
Phone +91 20 66292400

**USA**  
Baumer Ltd.  
US-Southington, CT 06489  
Phone +1 (1)860 621-2121

[www.baumer.com/worldwide](http://www.baumer.com/worldwide)

### Technische Daten

### Technical data

### Données techniques

Nennschaltabstand Sn	Nominal sensing distance Sn	Portée nominale Sn	4 mm
Einbautart	Mounting type	Type de montage	bündig/flush/noyé
Ausgangsschaltung	Output circuit	Circuit de sortie	Gegentakt Öffner/push-pull NC
Betriebsspannungsbereich +Vs	Voltage supply range +Vs	Plage de tension +Vs	10...30 VDC (UL Class 2)
Stromaufnahme max.	Current consumption max.	Consommation max.	< 15 mA
Ausgangsstrom	Output current	Courant de sortie	100 mA
Schaltfrequenz	Switching frequency	Fréquence de commutation	< 35 Hz
Kurzschlussfest	Short circuit protection	Protégé contre courts-circuits	Ja/yes/oui
Verpolungsfest	Reverse polarity protection	Protégé contre inversion polarité	Ja/yes/oui
Material (aktive Fläche)	Material (sensing face)	Matériau (face active)	PA 12
Gehäusematerial	Housing material	Matériau du boîtier	PA 12
Schutzklasse	Protection class	Classe de protection	IP65
Arbeitstemperatur	Operating temperature	Température de fonctionnement	-25...+75°C

**Montagearten**  
**Mounting versions**  
**Types de montage**

Mit Senkkopfschrauben  
 With countersunk screw  
 Avec vis à tête fraisée

Mit Kabelbinder  
 With cable ties  
 Avec colliers serre-câbles

Mit Klettband  
 With Velcro strip  
 Avec bande Velcro

Kaskadierte Montage  
 Cascaded mounting  
 Montage en cascade

Fixierung mit Klebepads oder Klebstoff  
 Fixation with adhesive pads or glue  
 Fixation avec supports adhésifs ou avec de la colle

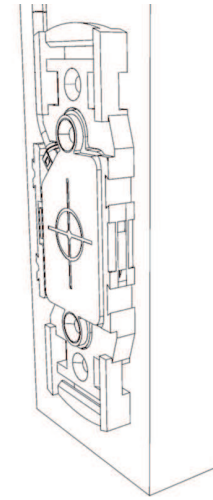
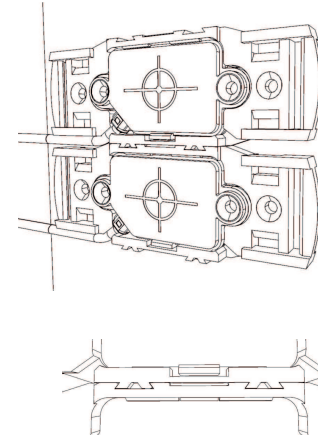
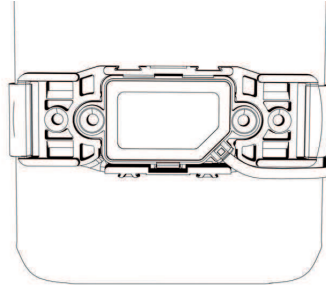
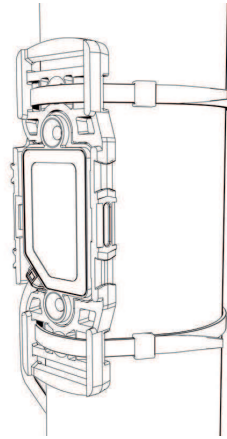
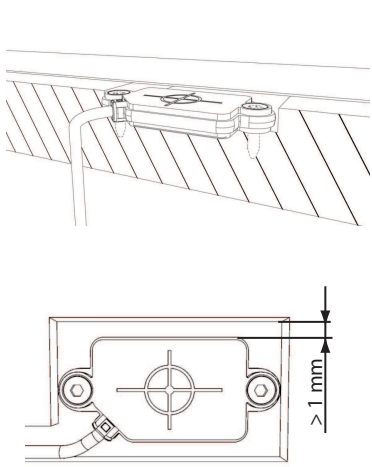

**Zubehör**  
**Accessories**  
**Accessoires**

Montagekit für CFDK 25  
 Mounting kit for CFDK 25  
 Kit de montage pour CFDK 25

Bestehend aus / consisting of / composé de:  
 - 1x Montagerahmen HC25 / mounting frame HC25 / cadre de montage HC25  
 - 2x Kabelbinder 186x4,7mm / cable ties 186x4,7mm / colliers serre-câbles 186x4,7mm  
 - 2x Klebepads / adhesive pads / supports adhésifs /  
 - 2x Distanznocken / spacers / entretoises

Bestellbezeichnung / order reference / référence de la commande  
 HC25-1 Kit CFDK 25

Klettband für Montagerahmen HC25  
 Velcro strip for mounting frame HC25  
 Bande Velcro pour cadre de montage HC25

Bestellbezeichnung / order reference / référence de la commande

BX 20-360-1	l = 360 mm
BX 20-1200-1	l = 1200 mm
BX 20-2000-1	l = 2000 mm
BX 20-4000-1	l = 4000 mm

**Snap-in** Ohne Werkzeug  
 Without tools  
 Sans outils

1. Rahmen befestigen  
 1. Fix the frame  
 1. Fixer le cadre

2. Sensor einklicken  
 2. Snap in the sensor  
 2. Encliqueter le détecteur

3. Fertig  
 3. Ready  
 3. Terminé

