

THD Series

Indoor, Duct & Wall mounting type Temperature/Humidity transducer

■ Features

- Compact design
- Built-in temp./humidity sensor
- 7 Segment LED Display(THD-DD/THD-WD)
- Various output modes
DC4-20mA, 1-5VDC, RS485(Modbus RTU)
- Wide range of temp./humidity measurement
-19.9 to 60.0°C / 0.0 to 99.9%RH
- Communication speed: 115200bps

 Please read "Caution for your safety" in operation manual before using.

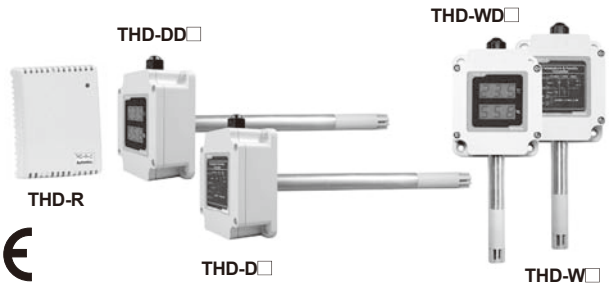

■ Ordering information

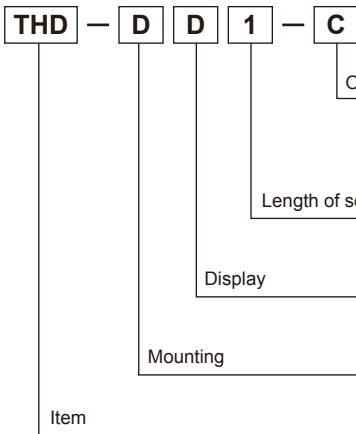

| | |
|-----------|--|
| ※ PT | DPT100Ω resistance value(Temp.) |
| ※ PT/C | DPT100Ω resistance value(Temp.) / DC4-20mA current output (Humidity) |
| C | DC4-20mA current output (Temp./Humidity) |
| V | 1-5VDC voltage output (Temp./Humidity) |
| T | RS485 communication output Modbus RTU (Temp./Humidity) |
| ※ No mark | Built-in |
| 1 | 100mm |
| 2 | 200mm |
| No mark | Non-Display type |
| D | Display type |
| R | Room type(For indoor) |
| D | Duct mounting type |
| W | Wall mounting type |
| THD | Temperature Humidity Double |

※It is only for THD-R.

■ Specifications

| Model | THD-R-PT | THD-R-PT/C | THD-R-C THD-R-V THD-R-T | THD-D□-□ THD-W□-□ | THD-DD□-□ THD-WD□-□ |
|-------------------------|-------------------------------|--|--|----------------------|---------------------------------|
| Display type | — | Non-indicating type | | | 7Segment LED display |
| Display digit | — | — | | | Each 3digits for temp./humidity |
| Character size | — | — | | | W6.2×H10.0mm |
| Power supply | — | 24VDC | | | |
| Allowable voltage range | 90 to 110% of rated voltage | | | | |
| Power consumption | — | Max. 2.4W | | | |
| Measuring input | Temperature (Built-in sensor) | Temperature, Humidity(Built-in sensor) | | | |
| Output*1 | Temp. | DPT100Ω resistance value | DC4-20mA, 1-5VDC, RS485 communication output(Modbus RTU) | | |
| | Humidity | — | DC4-20mA | | |
| Measurement range | Temp. | -19.9 to 60.0°C | | | |
| | Humidity | — | 0.0 to 99.9%RH(THD-R is required to attend for using over 90%RH.) | | |
| Accuracy | Temp. | Max. ±0.8°C | -19.9 to 5.0°C: ±1.0°C, 5.0 to 40.0°C: ±0.5°C, 40.0 to 60.0°C: ±1.0°C rdg ±1digit (At below -10°C, within 1.5°C) | | |
| | Humidity | — | Max. ±3%RH at 30 to 70%RH (at 25 to 45°C) | | |
| Sampling cycle | — | Fixed in 0.5 sec. | | | |

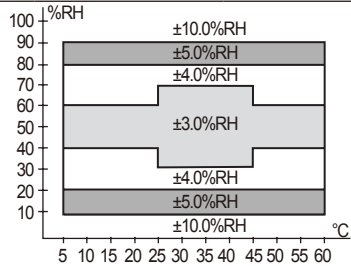

※1. The allowable impedance of current output is max. 600Ω

Temperature/Humidity Transducer

Specifications

| Model | THD-R-PT | THD-R-PT/C | THD-R-C THD-R-V THD-R-T | THD-D□-□ THD-W□-□ | THD-DD□-□ THD-WD□-□ |
|-----------------------|-----------------------------------|---|-------------------------------|---------------------------|------------------------|
| Insulation resistance | — | Min. 100MΩ(at 500VDC megger) | | | |
| Dielectric strength | — | 500VAC 50/60Hz for 1 minute | | | |
| Noise resistance | — | ±0.3kV the square wave noise(pulse width:1μs) by the noise simulator | | | |
| Vibration | Mechanical | 0.75mm amplitude at frequency of 10 to 55Hz(for 1 min.) in each of X, Y, Z directions for 1hour | | | |
| | Malfunction | 0.5mm amplitude at frequency of 10 to 55Hz(for 1 min.) in each of X, Y, Z directions for 10min. | | | |
| Shock | Mechanical | 300m/s ² (approx. 30G) in each of X, Y, Z directions for 3 times | | | |
| | Malfunction | 100m/s ² (approx. 10G) in each of X, Y, Z directions for 3 times | | | |
| Protection | IP10 | | | IP65(except sensing part) | |
| Ambient temperature | -20 to 60°C, storage: -20 to 60°C | | | | |
| Cable | Terminal type | | | 4-wire, ø4, Length: 2m | |
| Approval | CE | | | | |
| Unit weight | Approx. 55g | | | Approx. 160g | |

※ Environment resistance is rated at no freezing or condensation.

Dimensions

(unit: mm)

● THD-R□ / THD-R-PT / THD-R-PT/C

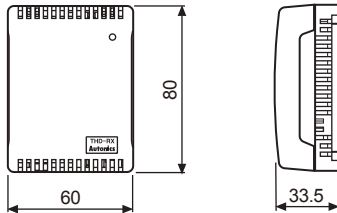

● Panel cut-out

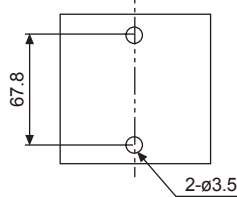

● THD-D□-□ / THD-DD□-□

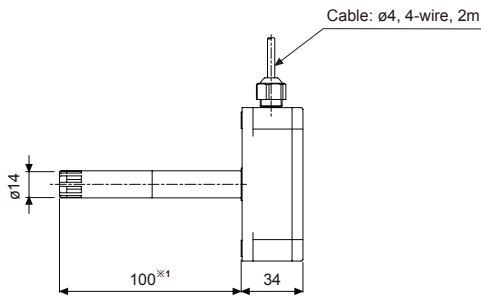

● THD-W□-□ / THD-WD□-□

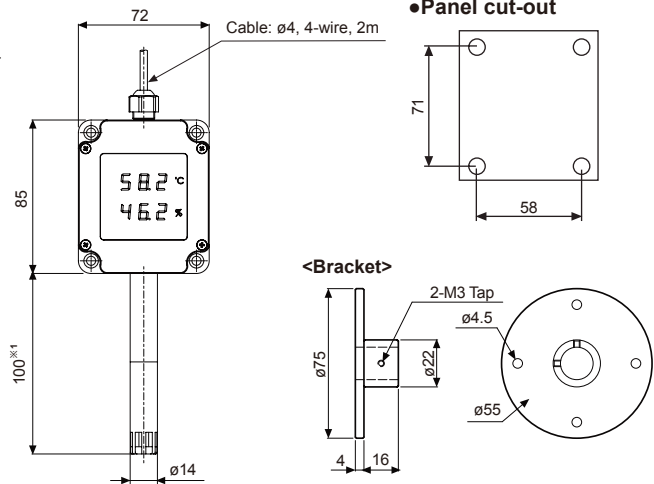

※1: Refer to the ordering information to select the one with 2 sensing poles (100m, 200m).

※Refer to the ordering information about display model, THD-DD□-□, THD-WD□-□.

Connections

◎ THD-R

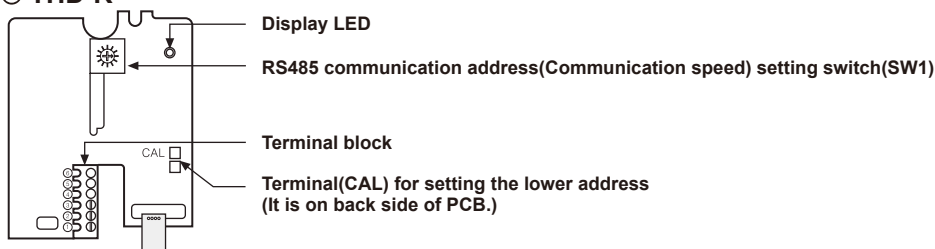

(A) Photo electric sensor

(B) Fiber optic sensor

(C) Door/Area sensor

(D) Proximity sensor

(E) Pressure sensor

(F) Rotary encoder

(G) Connector/Socket

(H) Temp. controller

(I) SSR/ Power controller

(J) Counter

(K) Timer

(L) Panel meter

(M) Tacho/ Speed/ Pulse meter

(N) Display unit

(O) Sensor controller

(P) Switching mode power supply

(Q) Stepper motor& Driver&Controller

(R) Graphic/ Logic panel

(S) Field network device

(T) Software

(U) Other

THD Series

● THD-R-PT/C

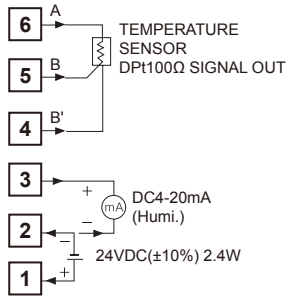

● THD-R-C, V, T

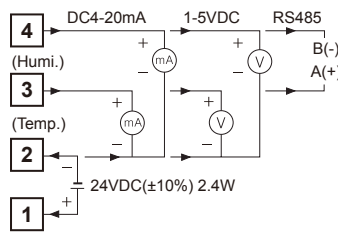

※Check terminal connection diagram and wire the power supply part carefully.

● THD-R-PT

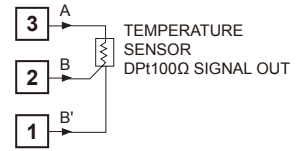

◎ THD-D / THD-W

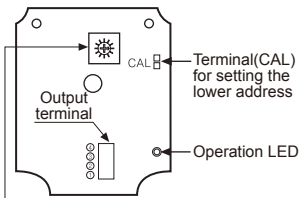

※Separate the case cover only in case of setting communication, the unit code, communication speed with operation of the communication setting switch.

● Current output type

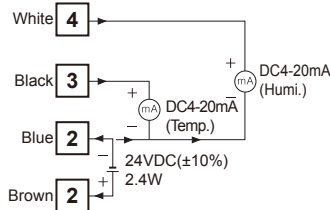

● Voltage output type

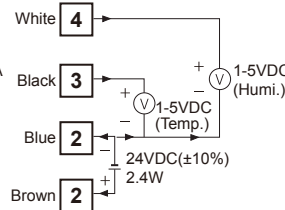

● Comm. output type

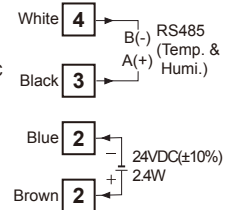

■ Case detachment

● THD-R

Unfasten the bolt on the bottom of the product, separate the case from it.

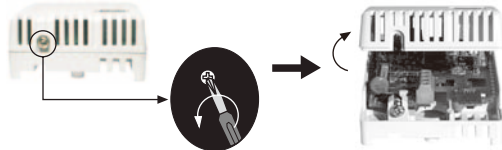

● THD-D / THD-W

Unfasten 4 bolts on the top of the product, separate the case cover from it.

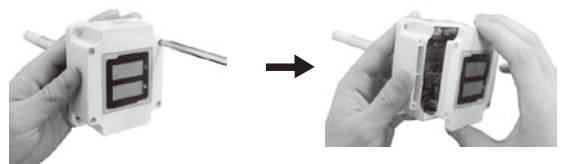

■ Functions

◎ Voltage output

It transmits current temperature/humidity to other devices (PC, recorder, etc.) and outputs 1-5VDC. It outputs 1VDC at -19.9°C of temperature and 0%RH of humidity, 5VDC at 60°C of temperature and 99.9%RH of humidity. The temperature and humidity output are separated and the resolution is divisible by 1,000.

◎ Current output

It transmits current temperature/humidity to other devices (PC, recorder, etc.) and outputs DC4-20mA. It outputs DC4mA at -19.9°C of temperature and 0%RH of humidity, DC20mA at 60°C of temperature and 99.9%RH of humidity. The temperature and humidity output are separated and the resolution is divisible by 1,000.

◎ Temperature sensor output(DPt 100Ω resistance value output)

It transmits current temperature to other devices (recorder, thermometer, etc.). It outputs 100Ω at 0°C and 119.40Ω at 50°C. (TCR=3850 ppm/°C)

Temperature/Humidity Transducer

■ RS485 communication output

It is output transmit current temperature and humidity to other devices by communication.

◎ Interface

| | |
|----------------------------------|-------------------------------|
| Standard | EIA RS485 |
| Maximum connections | 31(Address setting: 01 to 31) |
| Communication method | 2-wire half duplex |
| Synchronous method | Asynchronous |
| Effective communication distance | Max. 800m |
| Communication speed | 1200 to 115200bps(Setting) |
| Start bit | 1bit(Fixed) |
| Stop bit | 1bit(Fixed) |
| Parity bit | None(Fixed) |
| Data bit | 8bit(Fixed) |
| Protocol | Modbus RTU |

- ※It is not possible to change parameter related to communication of THD under the communication with high order system.
- ※Match the parameter of THD communication to be same as the high order system.
- ※It is not allowed to set overlapping communication address at the same communication line.
- ※Please use a proper twist pair for RS485 communication.

◎ Application of system organization

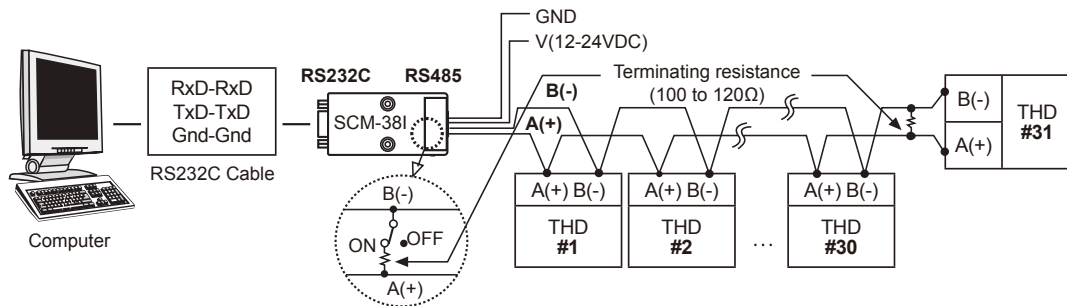

※It is recommended to use communication converter, RS232C to RS485 converter(SCM-381, sold separately), USB to RS485 converter(SCM-US481, sold separately).

◎ Ordering of communication control

- The communication method is Modbus RTU.
- After 0.5sec. being supplied the power into master system, it is able to start communication.
- The initial communication is started by master system. When a command comes out from the master system, THD will respond.

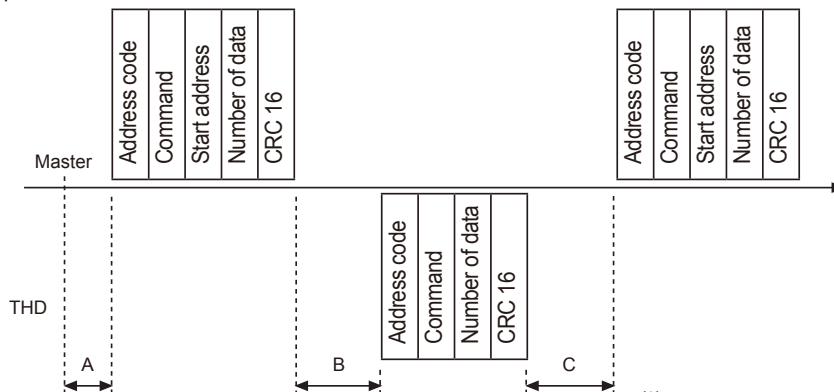

※A → Min. 0.5 sec. after supplying power
 B → Within(Communication speed×10)×10
 Ex) 9600bps=960cps=1.04ms×10
 ※C → Min. (Communication speed×10)×4

| | |
|-----|----------------------------------|
| (A) | Photo electric sensor |
| (B) | Fiber optic sensor |
| (C) | Door/Area sensor |
| (D) | Proximity sensor |
| (E) | Pressure sensor |
| (F) | Rotary encoder |
| (G) | Connector/Socket |
| (H) | Temp. controller |
| (I) | SSR/ Power controller |
| (J) | Counter |
| (K) | Timer |
| (L) | Panel meter |
| (M) | Tacho/ Speed/ Pulse meter |
| (N) | Display unit |
| (O) | Sensor controller |
| (P) | Switching mode power supply |
| (Q) | Stepper motor& Driver&Controller |
| (R) | Graphic/ Logic panel |
| (S) | Field network device |
| (T) | Software |
| (U) | Other |

THD Series

● Communication command and block

The format of query and response.

Query

| | | | | |
|--------------------------------|---------|---------------|----------------|-------|
| Address code | Command | Start address | Number of data | CRC16 |
| ← Calculation range of CRC16 → | | | | |

- ① Address code: This address code is for identifying THD by master system and able to set within range of 01 to 31.
- ② Command: Read command for input register
- ③ Start address: The start address of input register to read (Start address). It is available to select 0000 and 0001 for start address. 16bit data in the address 0000 indicates temperature value, 16bit data in the address 0001 indicates humidity value. (Refer to Modbus Mapping table.)
- ④ Number of data: The number of 16bit data from start address (No. of Points). When start address is 0000, it is available to read 2 of 16 bit data, or when start address is 0001, it is available to read 1 of 16 bit data.
- ⑤ CRC16: Checksum for checking the whole frame and it is used for more reliable transmit/receive to check the error between transmitter and receiver.

Response

| | | | | | |
|--------------------------------|---------|----------------|------------------|---------------|-------|
| Address code | Command | Number of data | Temperature data | Humidity data | CRC16 |
| ← Calculation range of CRC16 → | | | | | |

- ① Address code: This address code is for identifying THD by master system and able to set within range of 01 to 31.
- ② Command: A response for read command of input register
- ③ Number of data: The number of 8 bit data to send from start address (No. of bytes). When start address is 0000, it is available to read 4 of 8 bit data, or when start address is 0001, it is available to read 2 of 8 bit data. (Refer to Modbus Mapping table.)
- ④ Temperature data: This is the value of 16bit. To get a current temperature value, divide read value by 100.
Ex)When read data is 0x09B6, decimal value is 2486, the current value is 2486/100=24.86°C.
- ⑤ Humidity data: This is the value of 16bit. To get a current humidity value, divide read value by 100.
Ex)When read data is 0x12FE, decimal value is 4862, the current value is 4862/100=48.62%RH.
- ⑥ CRC16: Checksum for checking the whole frame. (Refer to L-35 page for CRC16 Table.)

● Application for communication command

(Query): Address code(01), Start address(0000), The number of 16 bit data to read(2) CRC16(0x71CB)

| | | | | | | | |
|--------------|---------|---------------|-----|----------------|-----|-------|-----|
| 01 | 04 | 00 | 00 | 00 | 02 | 71 | CB |
| Address code | Command | Start address | | Amount of data | | CRC16 | |
| | | High | Low | High | Low | High | Low |

(Response): Address code(01), The number of 8 Bit data to read(4), Temperature(0x09B6), Humidity(0x12FE) CRC(0x94DE)

| | | | | | | | | |
|--------------|------------------|----------------|------------------|-----|---------------|-----|-------|-----|
| 01 | 04 | 04 | 09 | B6 | 12 | FE | 94 | DE |
| Address code | Response command | Amount of data | Temperature data | | Humidity data | | CRC16 | |
| | | | High | Low | High | Low | High | Low |

● Error processing(Slave → Master)

1. Not supported command

| | | | | |
|--------------|------------------|----------------|-------|----|
| 01 | 81 | 01 | 81 | 90 |
| Address code | Response command | Exception code | CRC16 | |

※Set a received highest bit and send it to response command and exception code 01.

2. The start address of queried data is inconsistent with the transmittable address.

| | | | | |
|--------------|------------------|----------------|-------|----|
| 01 | 81 | 02 | 81 | 90 |
| Address code | Response command | Exception code | CRC16 | |

※Set a received highest bit and send it to response command and exception code 02.

3. The number of queried data is bigger than transmittable one.

| | | | | |
|--------------|------------------|----------------|-------|---|
| 01 | 84 | 03 | X | X |
| Address code | Response command | Exception code | CRC16 | |

※Set a received highest bit and send it to response command and exception code 03.

4. Abnormal operation for a received command

| | | | | |
|--------------|------------------|----------------|-------|---|
| 01 | 84 | 04 | X | X |
| Address code | Response command | Exception code | CRC16 | |

※Set a received highest bit and send it to response command and exception code 04.

Temperature/Humidity Transducer

◎ Setting communication speed

- 1) Set SW1 to 0 and apply the power.
 - 2) Operation indicator LED is flashing.
 - 3) Set a communication speed after choose SW1 within the range 1 to 8 and hold it for 3sec.
 - 4) After setting a communication speed, the LED will be ON. At the moment turn OFF the power.
- ※Factory default communication speed is 9600bps.
 ※In order to change the communication speed, please turn off the power and repeat step 1 to 4.

<Setting table for communication speed(bps)>

| SW1 | Communication speed(bps) |
|-----|--------------------------|
| 1 | 1200 |
| 2 | 2400 |
| 3 | 4800 |
| 4 | 9600 |
| 5 | 19200 |
| 6 | 38400 |
| 7 | 57600 |
| 8 | 115200 |

◎ Change the communication address

- 1) Set CAL terminal and SW1 at new address, apply the power.
 - 2) The communication address is changed automatically.
- ※Factory default communication address is 01. (SW1: 1, CAL terminal: Open)
 ※In order to change the communication address, please turn off the power and repeat step 1) to 2).
 ※Setting table of communication address

| CAL terminal | SW1 | Add no. | CAL terminal | SW1 | Add no. |
|--------------|-----|---------|--------------|-----|---------|
| OPEN | 1 | 01 | SHORT | 0 | 16 |
| OPEN | 2 | 02 | SHORT | 1 | 17 |
| OPEN | 3 | 03 | SHORT | 2 | 18 |
| OPEN | 4 | 04 | SHORT | 3 | 19 |
| OPEN | 5 | 05 | SHORT | 4 | 20 |
| OPEN | 6 | 06 | SHORT | 5 | 21 |
| OPEN | 7 | 07 | SHORT | 6 | 22 |
| OPEN | 8 | 08 | SHORT | 7 | 23 |
| OPEN | 9 | 09 | SHORT | 8 | 24 |
| OPEN | A | 10 | SHORT | 9 | 25 |
| OPEN | B | 11 | SHORT | A | 26 |
| OPEN | C | 12 | SHORT | B | 27 |
| OPEN | D | 13 | SHORT | C | 28 |
| OPEN | E | 14 | SHORT | D | 29 |
| OPEN | F | 15 | SHORT | E | 30 |
| — | — | — | SHORT | F | 31 |

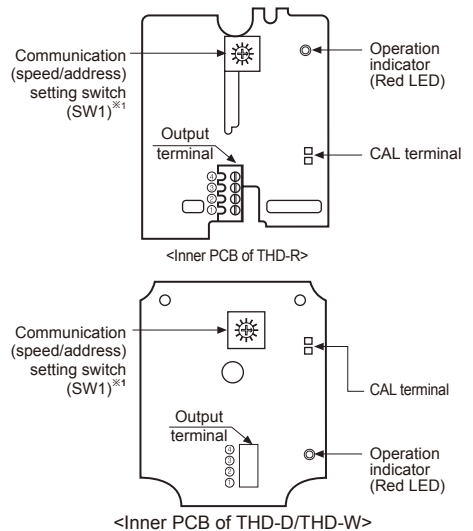

※1. Only when communication setting, remove the case cover and adjust the communication setting switch to set address and communication speed.

◎ Modbus Mapping Table

| Address | Item | Remark |
|-------------|-------------------|--------------------------|
| 30001(0000) | Temperature value | Temperature value × 0.01 |
| 30002(0001) | Humidity value | Humidity value × 0.01 |

※Visit our website(www.autonics.com) to download monitoring program for RS485 communication output.

■ Caution for using

- After checking the input specification, terminal polarity, connect the wires correctly.
- Do not connect a wire, examine and repair when the power is applying.
- Do not touch the temperature/humidity sensor by hands.
- This unit must be mounted on the wall. (THD-R)
- Caution for cleaning
 - Use dry towel.
 - Do not use acid, chrome acid, solvent but alcohol.
 - Turn off the power before cleaning the unit. After 30min. of cleaning, supply the power to the unit.
- Do not inflow dust or wire dregs into the unit.
- The connection wire of this unit should be separated from the power line and high voltage line in order to prevent from inductive noise.
- Keep away from the high frequency instruments.(High frequency welding machine & sewing machine, big capacitive SCR controller)
- The switch or circuit-breaker should be installed near by users.
- Installation environment
 - It shall be used indoor.
 - Altitude Max. 2000m.
 - Pollution Degree 2
 - Installation Category II.

| | |
|-----|----------------------------------|
| (A) | Photo electric sensor |
| (B) | Fiber optic sensor |
| (C) | Door/Area sensor |
| (D) | Proximity sensor |
| (E) | Pressure sensor |
| (F) | Rotary encoder |
| (G) | Connector/Socket |
| (H) | Temp. controller |
| (I) | SSR/ Power controller |
| (J) | Counter |
| (K) | Timer |
| (L) | Panel meter |
| (M) | Tacho/ Speed/ Pulse meter |
| (N) | Display unit |
| (O) | Sensor controller |
| (P) | Switching mode power supply |
| (Q) | Stepper motor& Driver&Controller |
| (R) | Graphic/ Logic panel |
| (S) | Field network device |
| (T) | Software |
| (U) | Other |