

ZXM Series

Light Duty Limit Switches



Specifications

Contact Arrangement	Ag Alloy, SPDT(1NO+1NC)
Insulation Resistance	100MΩ at 500V DC
Contact Resistance	Max. 25mΩ
Ambient Temperature	Operation: -20°C~+60°C, Storage: -30°C~+80°C
Ambient Humidity	90%RH Max
Degree of Protection	IP65

Operation Frequency	Electrical	Max. 30/min
	Mechanical	Max 120/min
Dielectric Strength	1,500VAC 50/60Hz 1min	
Expected Life	Electrical	Min. 300,000
	Mechanical	Min. 10,000,000

Contact Rating

Rated Voltage	Non-Inductive Load				Inductive Load			
	Resistive Load		Lamp Load		Inductive Load		Motor Load	
	NO	NC	NO	NC	NO	NC	NO	NC
125VAC	6A	6A	0.7A	1.5A	3A	3A	1A	2A
250VAC	6A	6A	0.5A	1A	3A	3A	0.8A	1.5A
500VAC	2A	2A	0.35A	0.75A	0.75A	0.75A	0.4A	0.75A
30VDC	5A	5A	3A	3A	4A	4A	3A	3A
125VDC	0.2A	0.4A	-	-	-	-	-	-
250VDC	0.2A	0.4A	-	-	-	-	-	-

Contact Diagram

24K Au Plt

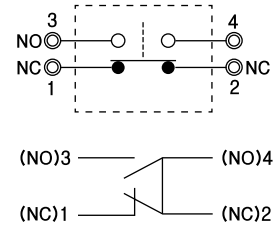
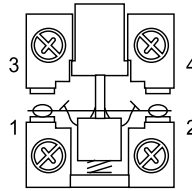

Dimensions

unit: mm



ZXM-301



ZXM-302



ZXM-312



ZXM-702

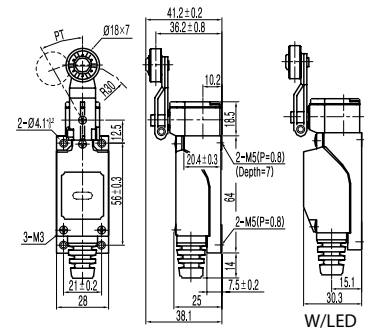
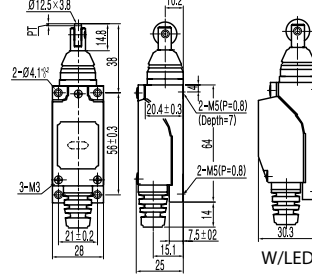
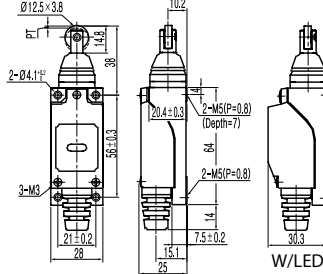
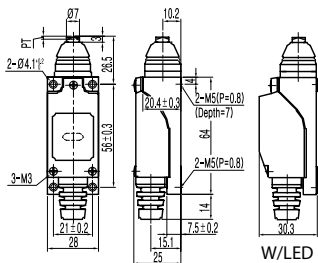

OF	900gf(8.83N)
RF	150gf (1.47N)
PT	1.5mm
MD	0.7mm
OT	4mm
TT	5.5mm

OF	900gf(8.83N)
RF	150gf (1.47N)
PT	1.5mm
MD	0.7mm
OT	4mm
TT	5.5mm

OF	900gf(8.83N)
RF	150gf (1.47N)
PT	1.5mm
MD	0.7mm
OT	4mm
TT	5.5mm

OF	600gf(5.88N)
RF	50gf (0.49N)
PT	20°
MD	10°
OT	75°
TT	95°

ZXM-703



ZXM-704



ZXM-726



ZXM-901

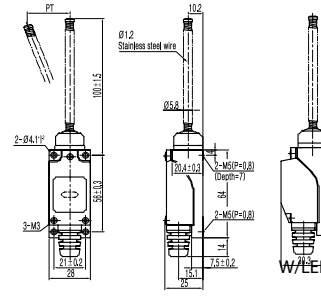
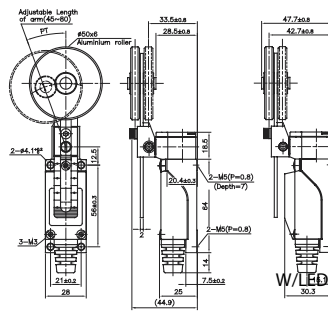
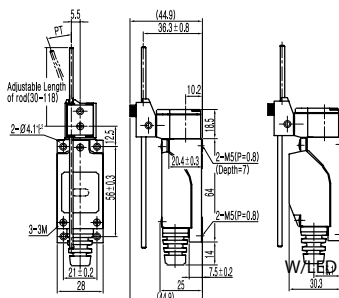
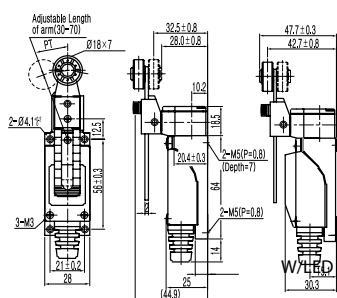

OF	800gf(7.84N)~342gf(3.35N)
RF	50gf(0.49N)~21gf(0.21N)
PT	20°
MD	10°
OT	75°
TT	95°

OF	800gf(7.84N)~203gf(1.99N)
RF	50gf(0.49N)~12gf(0.12N)
PT	20°
MD	10°
OT	75°
TT	95°

OF	800gf(7.84N)~342gf(3.35N)
RF	50gf(0.49N)~21gf(0.21N)
PT	20°
MD	10°
OT	75°
TT	95°

OF	90gf(0.88N)
RF	-
PT	30°
MD	-
OT	20°
TT	50°

ZXM-902

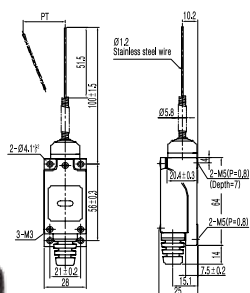

ZXM-903

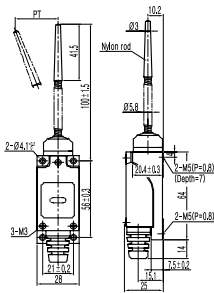

ZXM-923

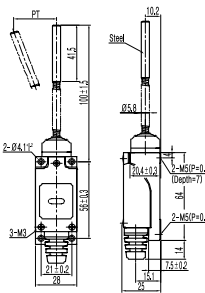

Option Parts

24K Gold Plated Contact Block
ZXM-101



Indicator Lamp

ZXM-102
LED 12 ~ 24V AC/DC
ZXM-103
Neon 80/240V AC



*Changable ON status at NC or NO

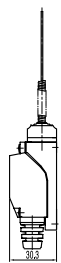

W/LED

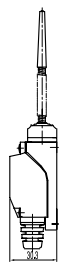

W/LED

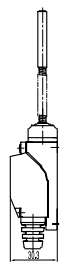

W/LED

OF	90gf(0.88N)
RF	-
PT	30°
MD	-
OT	20°
TT	50°

OF	90gf(0.88N)
RF	-
PT	30°
MD	-
OT	20°
TT	50°

OF	90gf(0.88N)
RF	-
PT	30°
MD	-
OT	20°
TT	50°

Tower Lights

Beacon Lights

LED Indicators
Pilot Lamps

Buzzer Alarms

Pushbutton Switches

Limit Switches

Foot Switches

SSR

Relay & Sockets

Relay Terminal Blocks

Terminal Blocks

Fuse Holders

Enclosures

G5