

Altech Corp.®

Serving the Automation & Control Industry since 1984

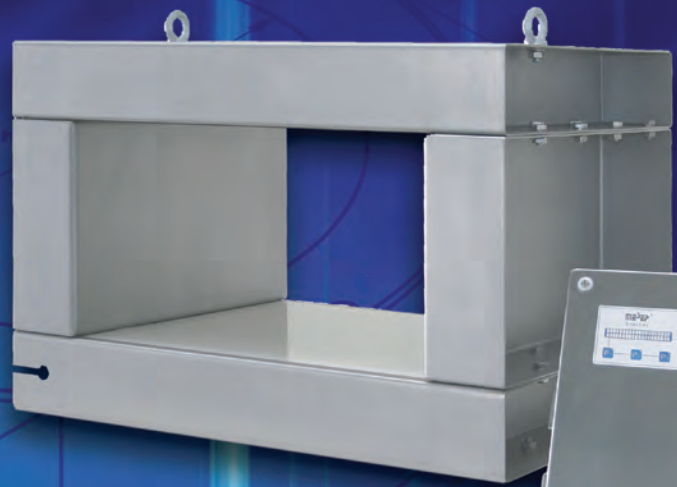

ISO 9001
QMI-SAI Global

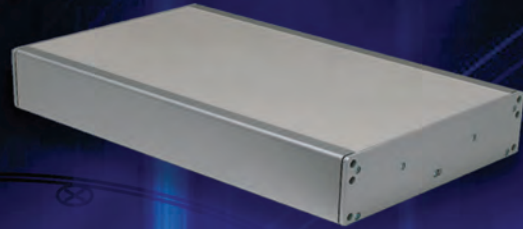
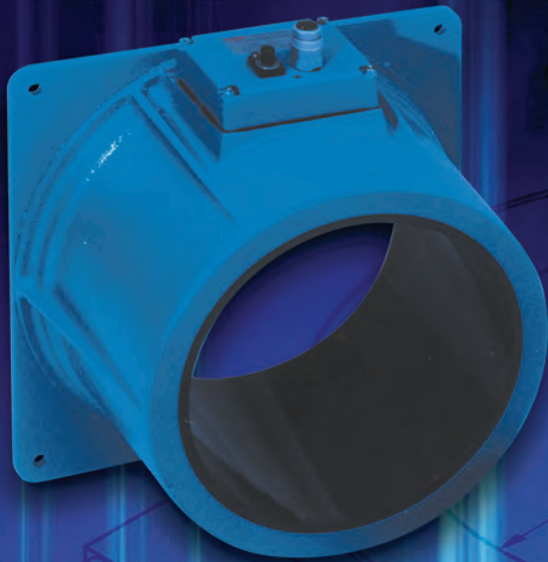

Metal Detection Systems

Altech Corp.®

Since 1984, Altech Corporation has grown to become a leading supplier of automation and industrial control components. Headquartered in Flemington, NJ, Altech has an experienced staff of engineering, manufacturing and sales personnel to provide the highest quality products with superior service. This is the Altech Commitment!

With experienced Product Engineers and Customer Service personnel, Altech provides solutions to your most pressing application challenges. All with one thought in mind - *to ensure that we solve your problem the first time!*



Altech's Commitment

Altech's Automation and Control components meet applicable national and international standards, such as UL, NEC, CSA, IEC and VDE. Altech provides these products with superior customer service and delivery through a ISO 9001 Quality Management system, which stresses continuous process improvement. We perform these services with honesty and integrity. All Altech employees are trained in this Quality Management System and are dedicated to achieve these goals. Altech's quality system has been ISO approved since 1999.



RING SENSORS

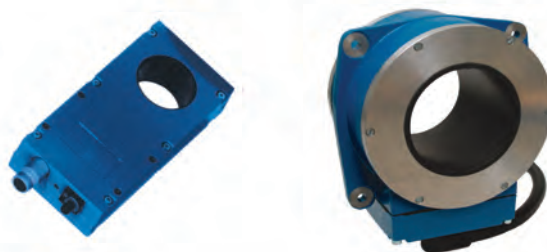

RING SENSOR GENERAL INFORMATION4-5
NORMAL SENSITIVITY RING SENSORS6-7
HIGH SENSITIVITY RING SENSORS8-9
ACCESSORIES FOR RING SENSORS10
ULTRA HIGH SENSITIVITY RING SENSORS11-12

FLAT SENSORS

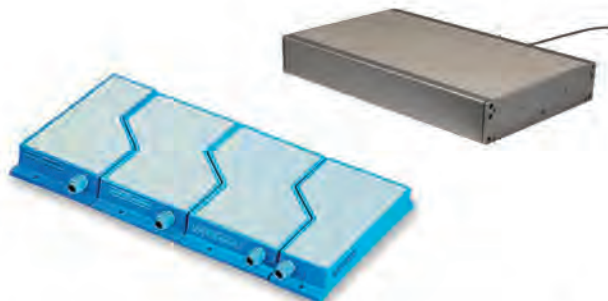

MODULAR FLAT PACK SENSORS13-14
SP SERIES FLAT SENSORS15
CONTROL UNIT FOR FLAT PACK AND SP SERIES16
FS SERIES MULTI-CHANNEL FLAT SENSOR17

TUNNEL SENSORS



BD SERIES TUNNEL SENSORS18
TU SERIES TUNNEL SENSORS19
CONTROL UNITS FOR TUNNEL SENSORS20-21

Altech offers 3 types of Ring Sensors with different operating principles. They have different features and advantages.

NORMAL SENSITIVITY RING SENSORS

They are **Static Type Ring Sensors** and their advantage is the ability to detect non-moving static objects. If metal is within its detecting range it generates a permanent output signal. Only when the metal object is removed the signal is deactivated. Due to the working principle the sensitivity is lower than on dynamic Ring Sensors.

Applications include Freefall applications to detect the presence of metal objects, count metal parts or ejection control in punching/ stamping applications, wire breakage and avoid unwanted metal objects in grinding operations. They are used for larger metal objects.

Features

- Static Sensor Technology
- Robust Aluminum housing
- 10-30VDC supply
- Various Ring Diameters 50-300mm
- Complementary NO/ NC output

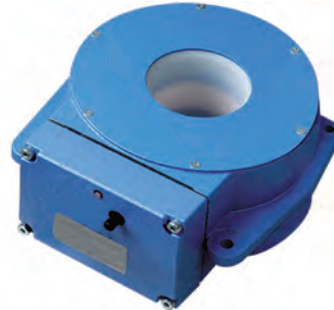

HIGH SENSITIVITY RING SENSORS

They are **Dynamic Type Ring Sensors** and generate a short signal pulse when metal is detected within its detecting range. Only moving metal objects can be detected. Sensitivity on dynamic Ring sensors is higher than on static type sensors. Therefore smaller objects can be detected.

Applications include Freefall applications to detect the presence of metal objects, count metal parts or ejection control in punching/ stamping applications, wire breakage and avoid unwanted metal objects in grinding operations. They are used for much smaller metal objects than the normal sensitivity Ring sensors.

Features

- Dynamic Sensor Technology
- Robust Aluminum housing
- 0.6mm sensitivity
- 11-30VDC supply
- Various Ring Diameters 50-300mm
- Complementary NO/ NC output



ULTRA HIGH SENSITIVITY RING SENSORS

Ultra High Sensitivity Ring Sensors work different than standard metal sensors. Their system is based on 3 coils. This allows the end user to analyze signals precisely. It is possible to differentiate different targets and draw conclusions on their origin.

Applications include all of the above, but Ultra High Sensitivity Ring Sensors are used primarily for the detection of **very small particles** in bulk material (Pharmaceutical products, Food and animal feed, granulated polymer materials, etc...).

Features

- 3 coil system
- Robust Aluminum housing
- 0.2mm sensitivity
- Including stainless steel control unit for Signal Analysis
- Various Ring Diameters 25-100mm

RING SENSOR SELECTION CHART

Table 1 allows the user to choose the appropriate Ring Sensor for his Application. The sensitivity shows the smallest detectable ferrous metal object. Environmental conditions or vibrations can decrease the sensitivity.

Sensitivity - Minimum detectable Steel Ball (diameter) in mm

Series/ Type	Diameter	0.20	0.30	0.35	0.60	0.80	1.00	1.30	3.00	4.00	5.00	6.00	8.00	12.00	15.00	30.00	Page
Normal Sensitivity	KJR-D50FAN-DxA	50mm							X								6
	KJR-D100AN-DxA	100mm										X					6
	KJR-D100FAN-DxA	100mm											X				6
	KJR-D200AN-DxA	200mm												X			7
	KJR-D300AN-DxA	300mm													X		7
	KJR-Q130AN-DxA	130x130mm												X			7
High Sensitivity	KJR-D50AN-DxIA	50mm			X												8
	KJR-D50FAN-DxIA	50mm					X										8
	KJR-D70AN-DxIA	70mm					X										8
	KJR-D100AN-DxIA	100mm						X									9
	KJR-D200AN-DxIA	200mm							X								9
	KJR-D300AN-DxIA	300mm								X							9
	KJR-Q130AN-DxIA	130x130mm									X						10
	KJR-Q290AN-DxIA	290x245mm												X			10
Ultra High Sensitivity	AMD-RG25	25mm	X														12
	AMD-RG35	35mm		X													12
	AMD-RG50	50mm			X												12
	AMD-RG70	70mm				X											12
	AMD-RG100	100mm					X										12

Table 1

SENSITIVITY CHART

Sensitivity of Ring sensors is given in terms of a steel ball diameter. It is the minimum diameter steel ball the sensor will be detect under lab conditions (20°C, no vibration, no additional electromagnetic field, etc.). Non-ferrous materials will require larger diameter parts for correct detection from the sensor. Table 2 shows with correction factors for other types of metals.

Actual Sensitivity depends on various factors. Unfavorable environmental conditions (Temperature, Humidity) or vibrations can reduce the sensitivity. Please contact Altech form more information. Send us a sample of your smallest metal target and we will test it!

ST37	1
Stainless Steel	1-1.6
Aluminum	1.8-2.3
Copper	1.9-2.4
Brass	1.8-2.3

Table 2. Correction factors for different metal types.

RING SENSOR MOUNTING – METAL-FREE ZONES

When Normal and High Sensitivity Ring Sensors are mounted near or in non-target metal objects, the following metal free areas need to be considered (Table 3):

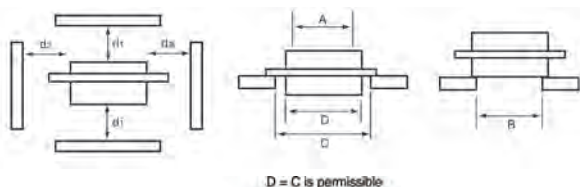

Sensor Type	Inner Diameter		Side Distance	
	Sensor = A	Mounting Plate = B*	d1	d2
KJR-D50AN	50mm	>85mm	>60mm	0
KJR-D50FAN	50mm	>85mm	>50mm	0
KJR-D70AN	70mm	>120mm	>65mm	0
KJR-D100AN	100mm	>180mm	>100mm	>30mm
KJR-D200AN	202mm	>260mm	>150mm	0
KJR-D300AN	294mm	>400mm	>200mm	0

* Mounting Plate must not move!

Table 3

RING SENSORS

NORMAL SENSITIVITY RING SENSORS

FEATURES:

- 10-30VDC Supply
- Detection and Counting Application
- Compact and Robust Design
- Static Sensor Technology
- Various Ring Diameters (50-300mm)



RING DIAMETER	50mm (1.97in.)	100mm (3.94in.)	100mm (3.94in.)
SENSITIVITY	3.0mm (0.12in.)	6.0mm (0.24in.)	8.0mm (0.31in.)

Part No.

NPN Output	KJR-D50FAN-DNA-V2	KJR-D100AN-DNA-V2	KJR-D100FAN-DNA-V2
PNP Output	KJR-D50FAN-DPA-V2	KJR-D100AN-DPA-V2	KJR-D100FAN-DPA-V2

Sensor Data

Output	NO/ NC	NO/ NC	NO/ NC
Switching Frequency	500Hz	500Hz	500Hz
Switching State	LED	LED	LED
Connector	M12, 4 pole	M12, 4 pole	M12, 4 pole

Electrical Data

Operating Voltage	10-30VDC	10-30VDC	10-30VDC
Off-state Current	≤ 15mA	≤ 15mA	≤ 15mA
Max. Load Current	200mA	200mA	200mA
Residual Current	≤ 10μA	≤ 10μA	≤ 10μA
Ripple Voltage	≤ 10%	≤ 10%	≤ 10%
Voltage Drop	≤ 2.4V	≤ 2.4V	≤ 2.4V
Hysteresis	≤ 15%	≤ 15%	≤ 15%

Environmental Data

Operating Temperature	-25°C to +70°C (-13°F to +158°F)	-25°C to +70°C (-13°F to +158°F)	-25°C to +70°C (-13°F to +158°F)
Protection Class	IP54	IP54	IP54
Housing Material	Aluminum	Aluminum	Aluminum

Accessories (page 11)

M12 Connecting Cable	2m	9512-5310	9512-5310	9512-5310
	5m	9512-5312	9512-5312	9512-5312
SDK4 Connecting Cable	2m	-	-	-
	5m	-	-	-
Control Unit	230VAC/ 24VDC	8349005011	8349005011	8349005011
	115VAC/ 24VDC	8349005013	8349005013	8349005013

Dimensions

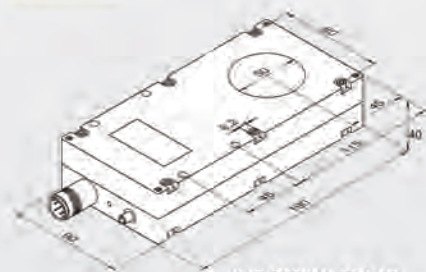

KJR-D50FAN-DNA-V2
KJR-D50FAN-DPA-V2

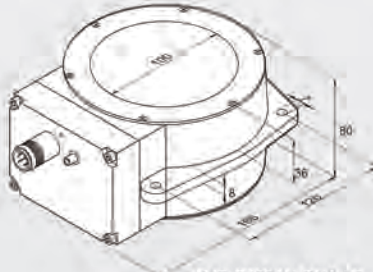

KJR-D100AN-DNA-V2
KJR-D100AN-DPA-V2

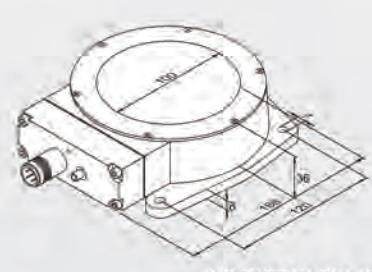

KJR-D100FAN-DNA-V2
KJR-D100FAN-DPA-V2

FEATURES:

- 10-30VDC Supply
- Detection and Counting Application
- Compact and Robust Design
- Static Sensor Technology
- Various Ring Diameters (50-300mm)



RING DIAMETER	200mm (7.87in.)	300mm (11.81in.)
SENSITIVITY	15.0mm (0.59in.)	30.0mm (1.18in.)

Part No.

NPN Output	KJR-200AN-DNA-V2	KJR-D300AN-DNA-V2
PNP Output	KJR-200AN-DPA-V2	KJR-D300AN-DPA-V2

Sensor Data

Output	NO/ NC	NO/ NC
Switching Frequency	300Hz	300Hz
Switching State	LED	LED
Connector	M12, 4 pole	M12, 4 pole

Electrical Data

Operating Voltage	10-30VDC	10-30VDC
Off-state Current	≤ 10mA	≤ 10mA
Max. Load Current	200mA	200mA
Residual Current	≤ 10μA	≤ 10μA
Ripple Voltage	≤ 10%	≤ 10%
Voltage Drop	≤ 2.4V	≤ 2.4V
Hysteresis	≤ 15%	≤ 15%

Environmental Data

Operating Temperature	-25°C to +70°C (-13°F to +158°F)	-25°C to +70°C (-13°F to +158°F)
Protection Class	IP54	IP54
Aluminum	Aluminum	Aluminum

Accessories (page 11)

M12 Connecting Cable	2m	9512-5310	9512-5310
	5m	9512-5312	9512-5312
SDK4 Connecting Cable	2m	-	-
	5m	-	-
Control Unit	230VAC/ 24VDC	8349005011	8349005011
	115VAC/ 24VDC	8349005013	8349005013

Dimensions

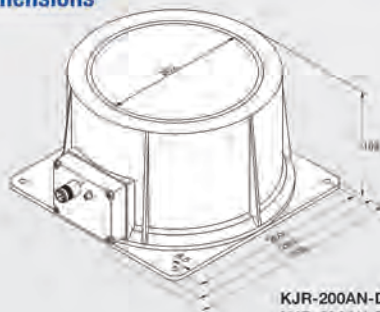

KJR-200AN-DNA-V2
KJR-200AN-DPA-V2

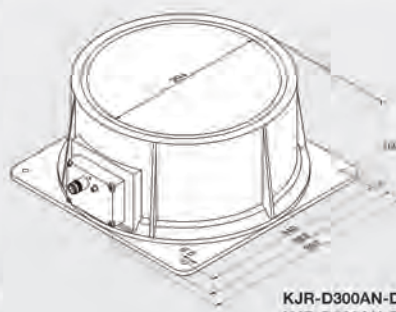

KJR-D300AN-DNA-V2
KJR-D300AN-DPA-V2

RING SENSORS

HIGH SENSITIVITY RING SENSORS

FEATURES:

- High Sensitivity (0.6mm)
- 10-30VDC Supply
- Detection and Counting Application
- Compact and Robust Design
- Dynamic Sensor Technology
- Various Ring Diameters



RING DIAMETER	50mm (1.97in.)	50mm (1.97in.)	70mm (2.76in.)
SENSITIVITY	0.6mm (0.02in.)	1.0mm (0.04in.)	1.0mm (0.04in.)

Part No.

NPN Output	KJR-D50AN-DNIA-V2	KJR-D50FAN-DNIA-V2	KJR-D70AN-DNIA-V2
PNP Output	KJR-D50AN-DPIA-V2	KJR-D50FAN-DPIA-V2	KJR-D70AN-DPIA-V2

Sensor Data

Output	NO/ NC	NO/ NC	NO/ NC
Switching Frequency	100Hz	100Hz	100Hz
Switching State	LED	LED	LED
Connector	M12, 4 pole	M12, 4 pole	M12, 4 pole

Electrical Data

Operating Voltage	11-30VDC	11-30VDC	11-30VDC
Off-state Current	≤ 25mA	≤ 25mA	≤ 25mA
Max. Load Current	50mA	50mA	50mA
Residual Current	≤ 10μA	≤ 10μA	≤ 10μA
Ripple Voltage	≤ 10%	≤ 10%	≤ 10%
Voltage Drop	≤ 2.4V	≤ 2.4V	≤ 2.4V
Hysteresis	≤ 15%	≤ 15%	≤ 15%

Environmental Data

Operating Temperature	-25°C to +70°C (-13°F to +158°F)	-25°C to +70°C (-13°F to +158°F)	-25°C to +70°C (-13°F to +158°F)
Protection Class	IP54	IP54	IP54
Housing Material	Aluminum	Aluminum	Aluminum

Accessories (page 11)

M12 Connecting Cable	2m	9512-5310	9512-5310	9512-5310
	5m	9512-5312	9512-5312	9512-5312
SDK4 Connecting Cable	2m	-	-	-
	5m	-	-	-
Control Unit	230VAC/ 24VDC	8349005011	8349005011	8349005011
	115VAC/ 24VDC	8349005013	8349005013	8349005013

Dimensions

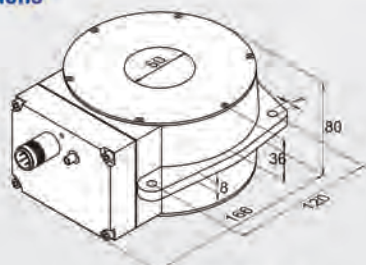

KJR-D50AN-DNIA-V2
KJR-D50AN-DPIA-V2

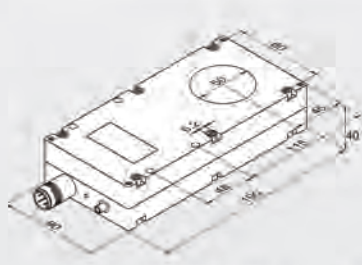

KJR-D50FAN-DNIA-V2
KJR-D50FAN-DPIA-V2

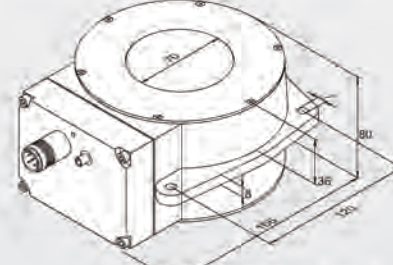

KJR-D70AN-DNIA-V2
KJR-D70AN-DPIA-V2

FEATURES:

- High Sensitivity (0.6mm)
- 10-30VDC Supply
- Detection and Counting Application
- Compact and Robust Design
- Dynamic Sensor Technology
- Various Ring Diameters

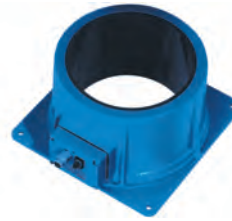

RING DIAMETER	100mm (3.94in.)	200mm (7.87in.)	300mm (11.81in.)
SENSITIVITY	1.3mm (0.05in.)	3.0mm (0.12in.)	4.0mm (0.16in.)

Part No.

NPN Output	KJR-D100AN-DNIA-V2	KJR-200AN-DNIA-V2	KJR-D300AN-DNIA-V2
PNP Output	KJR-D100AN-DPIA-V2	KJR-200AN-DPIA-V2	KJR-D300AN-DPIA-V2

Sensor Data

Output	NO/ NC	NO/ NC	NO/ NC
Switching Frequency	100Hz	100Hz	100Hz
Switching State	LED	LED	LED
Connector	M12, 4 pole	M12, 4 pole	M12, 4 pole

Electrical Data

Operating Voltage	11-30VDC	11-30VDC	11-30VDC
Off-state Current	≤ 25mA	≤ 25mA	≤ 25mA
Max. Load Current	50mA	50mA	50mA
Residual Current	≤ 10μA	≤ 10μA	≤ 10μA
Ripple Voltage	≤ 10%	≤ 10%	≤ 10%
Voltage Drop	≤ 2.4V	≤ 2.4V	≤ 2.4V
Hysteresis	≤ 15%	≤ 15%	≤ 15%

Environmental Data

Operating Temperature	-25°C to +70°C (-13°F to +158°F)	-25°C to +70°C (-13°F to +158°F)	-25°C to +70°C (-13°F to +158°F)
Protection Class	IP54	IP54	IP54
Aluminum	Aluminum	Aluminum	Aluminum

Accessories (page 11)

M12 Connecting Cable	2m	9512-5310	9512-5310	9512-5310
	5m	9512-5312	9512-5312	9512-5312
SDK4 Connecting Cable	2m	-	-	-
	5m	-	-	-
Control Unit	230VAC/ 24VDC	8349005011	8349005011	8349005011
	115VAC/ 24VDC	8349005013	8349005013	8349005013

Dimensions

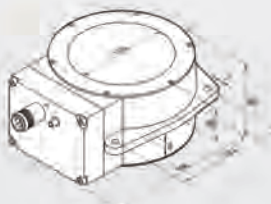

KJR-100AN-DNIA-V2
KJR-100AN-DPIA-V2

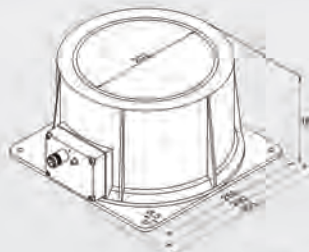

KJR-200AN-DNIA-V2
KJR-200AN-DPIA-V2

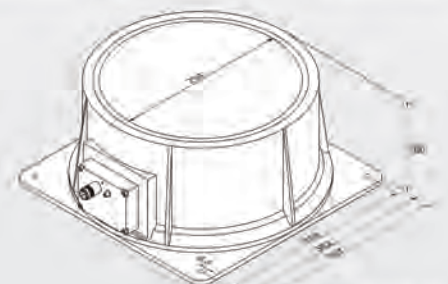

KJR-D300AN-DNIA-V2
KJR-D300AN-DPIA-V2

CONTROL UNIT FOR RING SENSORS

The Control Unit can be operated with all KJR Series Ring Sensors. It allows evaluation of the sensor signals and at the same time it is its power supply.

Features

- DIN Rail Mount
- For Use with all KJR Series Ring Sensors
- 115V AC and 230V AC version
- Operation with 24VDC
- Transistor and Relay Output
- Adjustable Pulse Duration of Output Signal
- Output signal can be retriggered

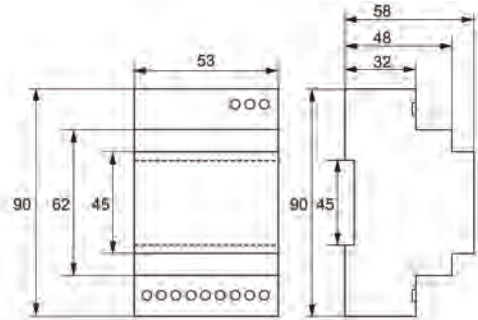

Technical Specifications

Part No.	8349005011	8349005013
Supply Voltage	230 VAC (50/60Hz), 24 VDC	115 VAC (50/60Hz), 24 VDC
Sensor Supply	24 VDC, max. 80mA (Overload and Short Circuit Protected)	24 VDC, max. 80mA (Overload and Short Circuit Protected)
Transistor Output	1 x NPN, 1 x PNP, 25mA open collector	1 x NPN, 1 x PNP, 25mA open collector
Relay Output	1 x SPDT, max. 250 VAC, 5A	1 x SPDT, max. 250 VAC, 5A
Output Pulse Duration	1..10s/ 1..60s adjustable	1..10s/ 1..60s adjustable
Operating Temperature	-10°C..+50°C	-10°C..+50°C
Storage Temperature	-10°C..+60°C	-10°C..+60°C
Protection Class	IP20	IP20
Housing Material	Polycarbonate (UL94V-0)	Polycarbonate (UL94V-0)

Operation

The Duration of a switching Pulse can be adjusted with a built in potentiometer. The User can choose between 2 Timing Ranges using the rotary coding switch. The same switch allows the user to (de) activate the relay output and choose if the connected sensor is NPN or PNP switching.

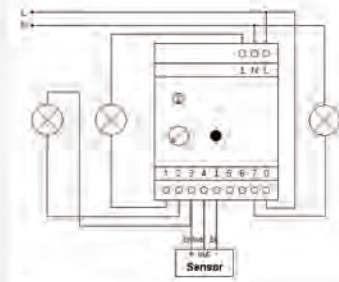

Wiring Example

SD4K Connector

CABLES FOR RING SENSORS



M12 4-pole

2m



5m

Part No.	2m	5m
M12 Connector Cable	9512-5310	9512-5312
SD4K Connector Cable	9512-0200	9512-0202

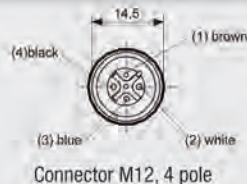

HIGH SENSITIVITY RING SENSORS

Ultra High Sensitivity Ring sensors are used in applications where the KJR Series is not sufficient. Advantages are their extremely High Sensitivity and the possibility to analyze the Sensor Signal to eliminate e.g. product effects with the included control unit.

Features

- Extremely High sensitivity (0.2mm metal targets)
- 85-265V AC universal supply voltage
- Stainless Steel Control Unit included
- Various Ring Diameters (25-100mm)
- Analysis of Sensor Signal

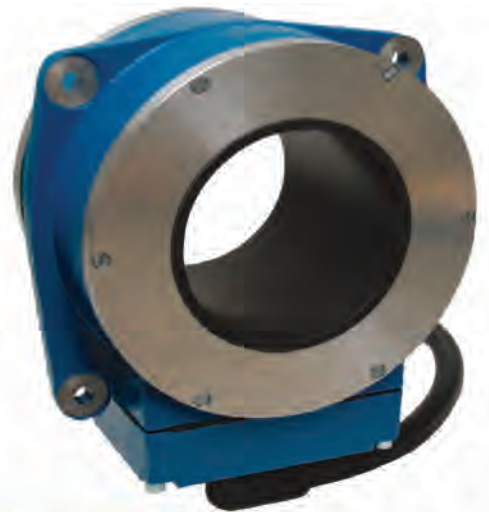

RING SENSORS (INCLUDING CONTROL UNIT)

Part No.	Sensitivity - min. detectable Object			
	Inner diameter	Height	Ferrous Steel	Stainless Steel
AMD-RG25-DPLUS	25mm	95mm	0.2mm	0.5mm
AMD-RG35-DPLUS	35mm	95mm	0.3mm	0.6mm
AMD-RG50-DPLUS	50mm	95mm	0.35mm	0.9mm
AMD-RG70-DPLUS	70mm	95mm	0.6mm	1.1mm
AMD-RG100-DPLUS	102mm	120mm	0.8mm	1.3mm

* Mounting Plate must not move!

Environmental Data

Operating Temperature	-10°C..+50°C (14°F..122°F)
Storage Temperature	-10°C..+50°C (14°F..140°F)
Protection Class Sensor	IP54
Protection Class Control Unit	IP65

Ring Sensor Mounting

The Ring Sensor is sensing metal partially above and under its opening. Bigger metal pieces can be already detected in that area. In order to guarantee correct functioning of the ring sensor areas above and under the device need to be kept free of metal (Metal-Free Zone). The Metal-Free Zone is different for non-moving (static) and moving dynamic (objects).

Metal-Free Zone Static parts: 1 x inner Diameter
Metal-Free Zone Dynamic parts: 1.5 x inner Diameter

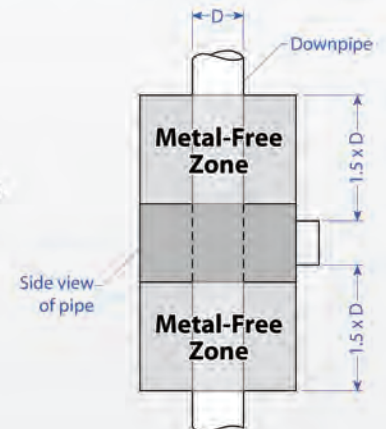

Dimensions

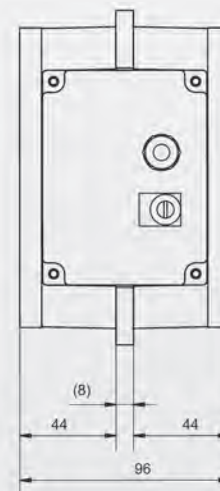
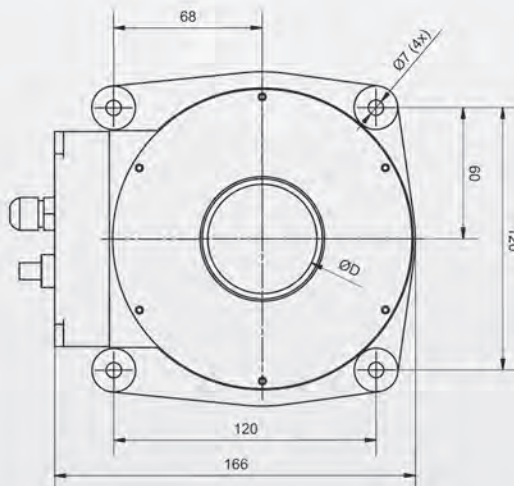

CONTROL UNIT ULTRA HIGH SENSITIVITY RING SENSORS

The Control Unit automatically controls and adjusts the connected sensor. This allows a maintenance-free operation. A32-Bit Processor System analysis the sensor data in realtime and filters out product effects and interferences. The device can be monitored via several In- and Outputs.

Features

- Stainless Steel Housing (IP65)
- Easy Handling and Operation
- High Sensitivity Application
- Fade-Out product Effect
- Maintenance Free operation

Technical Specifications

Part No.	included with AMD-RG Series
Supply Voltage	85-265 VAC, 50/60Hz
Power Consumption	max. 40W
Switching State	LED
Electrical Connection	3m connection cable (L1, N, Ground)
Digital I/O	
Digital Inputs	4
Digital Input Types	Optical isolated; VL= -5..-1.5V, VH= 6..50V; (Multifunction-Key, Ejector Guard)
Digital Outputs	6
Digital Output Types	PNP; max. 200mA (Transducer, Ejector, Device State)
Sensor - Transmitter	50 Ohm; Overload/ Short Circuit Proof (50..650kHz)
Sensor - Receiver	HDC-IQ - Receiver with Sensor-Readjustment
Serial Interfaces	2
Relay Output	2 SPDT; 250V, 1A
Voltage Output	24 VDC, Overload/ Short Circuit Proof; max. 2.5W for internal Components

Environmental Data

Operating Temperature	-10°C..+60°C
Storage Temperature	0°C..+50°C
Protection Class	IP65
Housing Material	Stainless Steel
Dimensions	200x300x80mm (7.9"x11.8"x3.2")
Weight	3000g (6.6lb)



Operation and Handling

Operation of the Control Unit is easy. The user can adjust the sensitivity and sets the parameters for various targets and their product effect. The parameters are set via the display and saved by pressing a button. Each saved product can be recalled by a single button. 3 LEDs signalize if there is a product loaded and which product it is.

The device is entirely maintenance-free. An integrated self-diagnosis tool immediately signalizes errors. All connections are pluggable.

Display

Keyboard	6 Keys (2 Selection Arrows, Enter, 3 x Keys for product)
Display	2 x 20 Characters, Backlit

Dimensions

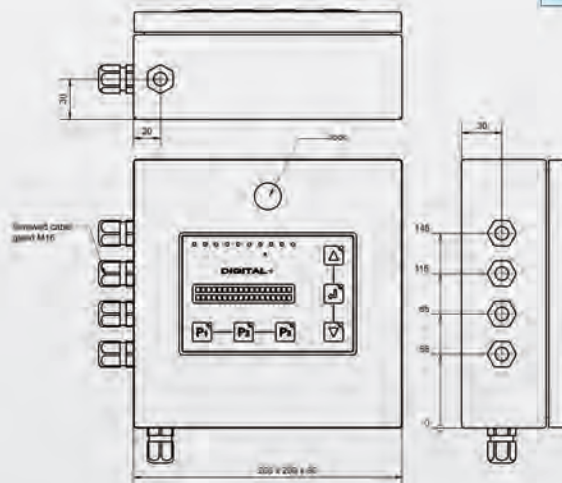

MODULAR FLAT PACK SENSORS

Altech Modular Flat Pack Sensors are used on conveyor belts and chutes to detect all types of metal in the material being handled. They are used for quality checks and machine protection. Other applications include counting of objects and completeness checks.

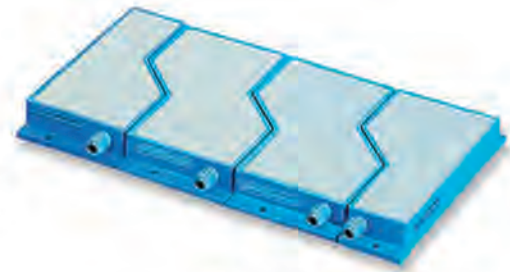

Features

- Most Flexible and Modular System
- Dynamic output for highest sensitivity
- 1 and 10 Channel Control Unit
- IP65

Technical Specifications

Electrical/ Supply Data	see Control Unit (Page 16)
Operating Temperature	-10°C..+50°C
Storage Temperature	-10°C..+50°C
Housing Material	Aluminum
Protection Class	IP65
Detection Speed	1...300 ft/min
Connection	2m PVC cable (other on request)

Sensitivity

Fe Plate 30x30x1mm	75mm
Fe Plate 12x12x1mm	55mm
Nut M6	45mm
Nut M4	35mm
Nut M2.5	26mm
Fe Ball 7mm	35mm
Fe Ball 3mm	15mm
Fe Ball 2mm	5mm

* Sensitivity show max. distance between sensor and target.

FLEXIBLE SYSTEM

The Flat Packs are available in 3 different sizes, all of which can be lined up with one another. This makes it a simple matter to create the required detector width from 3 standard elements. The width can also be changed at a later date when using the system. Control units are used to evaluate the signal from the flat packs.

SENSOR MODULES

	Module M140	Module M240	Module M95L	Module M95L
Frequency F1	NO/ NC	NO/ NC	NO/ NC	NO/ NC
Frequency F2	100Hz	100Hz	100Hz	100Hz
Frequency F3	LED	LED	LED	LED
Frequency F4	M12, 4 pole	M12, 4 pole	M12, 4 pole	M12, 4 pole

Dimensions

Width	140mm (5.5")	240mm (9.4")	95mm (3.7")	95mm (3.7")
Length	205mm (8.1")	205mm (8.1")	205mm (8.1")	205mm (8.1")
Height	28mm (1.1")	28mm (1.1")	28mm (1.1")	28mm (1.1")
Weight	1250g (2.75lb)	2500g (5.5lb.)	800g (1.76lb.)	800g (1.76lb.)

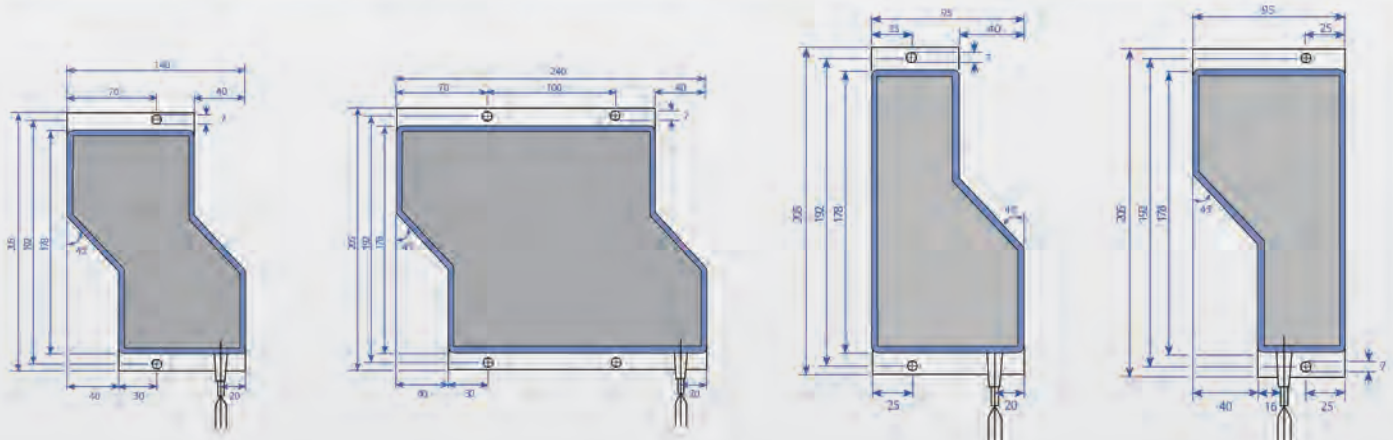

RULES FOR LINING UP ADJACENT FLAT SENSORS

Flat Sensors are designed to engage with neighboring modules. This ensures that all modules lined up in series have the same sensitivity.

- 1) A distance of at least 300mm must be maintained between sensors with the same module number (Figure 1).

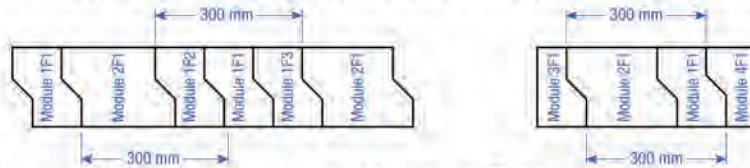

FIGURE 1

- 2) Flat sensors of different types can be lined up regardless of frequency (Figure 2).



FIGURE 2

RULES FOR SANDWICH CONSTRUCTION

Flat Packs can also be installed above and below the material being handled. This guarantees higher sensitivities.

- 1) In Sandwich construction, a minimum height of 40mm must be maintained between upper and lower sensors.
- 2) For sandwich construction there is different options:
 - a) Flat sensors of the same housing type are always used in pairs (above and below). Re-using a module number in such construction is not allowed. Therefore the max. width is 750mm. Size 95mm modules should always have different frequency numbers in a sandwich construction (Figure 3).



FIGURE 3

- b) Only wide sensors are used for the upper layer and only narrow sensors for the bottom layer or vice versa. In this case there is no limit in combinations, except to keep a distance of at least 600mm between identical sensors (Figure 4).



FIGURE 4

POSSIBLE COMBINATIONS

Total Sensor Width	Flat Sensor Combination	Total Sensor Width	Flat Sensor Combination
95mm	M95	595-600mm*	M95-M140-M240-M240
140mm	M140	640mm	M240-M240-M240
150-160mm*	M95-M95	650-660mm*	M95-M140-M240-M240-M95
240mm	M240	695-700mm*	M95-M240-M240-M240
250-260mm*	M95-M140-M95	740mm	M140-M240-M240-M240
295-300mm*	M95-M240	750-760mm*	M95-M240-M240-M240-M95
340mm	M140-M240	795-800mm*	M95-M140-M240-M240-M240
350-360mm*	M95-M240-M95	840mm	M240-M240-M240-M240
395-400mm*	M95-M140-M240	850-860mm*	M95-M140-M240-M240-M240-M95
440mm	M240-M240	895-900mm*	M95-M240-M240-M240-M240
450-460mm*	M95-M140-M240-M95	940mm	M140-M240-M240-M240-M240
495-500mm*	M95-M240-M240	950-960mm*	M95-M240-M240-M240-M240-M95
540mm	M140-M240-M240	995-1000mm*	M95-M140-M240-M240-M240-M240
550-560mm*	M95-M240-M240-M95	1040mm	M240-M240-M240-M240-M240

The Gaps between a M95 module and its neighboring flat pack must not exceed 5mm, otherwise the sensitivity will be impaired. The overall width can be increased accordingly this way.

SP SERIES FLAT SENSORS

Altech SP Series Flat Sensors are used on conveyor belts and chutes to detect all types of metal in the material being handled. They are used for quality checks and machine protection. Other applications include counting of objects and completeness checks.



Features

- Various Width available
- No Metal Free Zones necessary
- Stable and Shock proof Aluminum housing
- IP65
- Sensitivity adjustable via control unit

Technical Specifications

Electrical/ Supply Data	see Control Unit (Page 16)
Connection	2m PVC cable (other on request)
Housing Material	Aluminum
Active Surface	Polyurethane
Dimensions	Width x 210 x 60.5mm
Length	150..1200mm

Environmental Data

Operating Temperature	0°C..+50°C
Storage Temperature	-10°C..+50°C
Protection Class	IP65

Control Unit (Page 16)

1-Channel	8349005010/ 8349005012
10-Channel	8349005000/ 8349005001

Sensitivity

Fe Plate 30x30x1mm	95mm
Fe Plate 12x12x1mm	68mm
Nut M6	56mm
Nut M4	44mm
Nut M2.5	33mm
Fe Ball 7mm	44mm
Fe Ball 3mm	20mm
Fe Ball 2mm	8mm

* Sensitivity show max. distance between sensor and target.

ORDERING INFORMATION

Width	Part No.
150mm	AMD-SP150
200mm	AMD-SP200
250mm	AMD-SP250
300mm	AMD-SP300
350mm	AMD-SP350
400mm	AMD-SP400
450mm	AMD-SP450
500mm	AMD-SP500
XXXmm	AMD-SPXXX

The Flat Sensor has a Dynamic working principle which allows it to detect moving metal objects. Non-moving objects will not be detected. However the dynamic principle allows it to operate with a much higher sensitivity. Even small metal targets can be detected. The control unit is necessary for analysis of the sensor signal and it is power supply at the same time.

Standard Flat Sensors are available in steps of 50mm, any other length on request. Max. Length is 1200mm.

Dimensions

SP-Series 150-350mm length

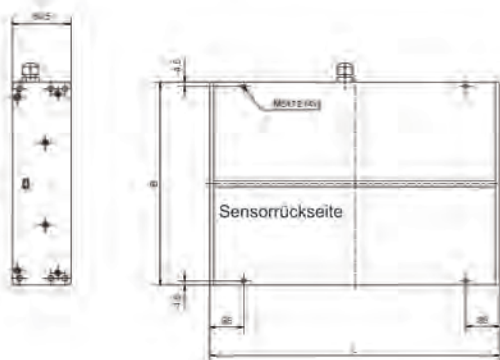

Dimensions SP-Series 350-1200mm length

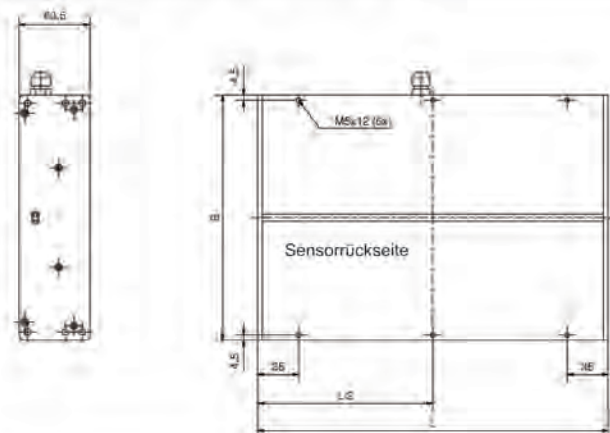

1-CHANNEL CONTROL UNIT FOR FLAT SENSORS

The Control Units can be operated with all Flat Pack and SP Series Flat Sensors. They allow evaluation of the sensor signals and at the same time they are their power supply.

Features

- DIN Rail Mount
- For Use with all Flat Pack and SP Series Sensors
- 115V AC and 230V AC version
- Operation with 24VDC
- Transistor and Relay Output
- Adjustable Pulse Duration of Output Signal



Dimensions

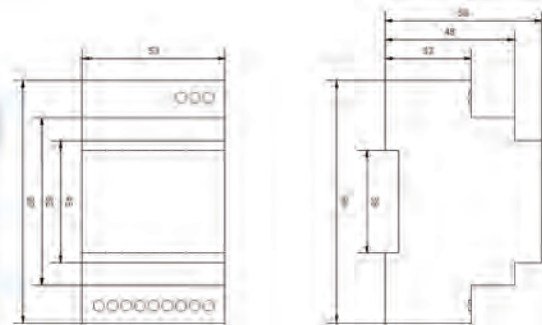

Technical Specifications

Part No.	8349005010	8349005012
Supply Voltage	230 VAC (50/60Hz), 24 VDC	115 VAC (50/60Hz), 24 VDC
Sensor Supply	15VDC, max. 80mA (Overload and Short Circuit Protected)	
Transistor Output	1 x NPN, 1 x PNP, 20mA open collector	
Relay Output	1 x SPDT, max. 250 VAC, 5A	
Speed	1..10/ 1..30/1-100/1-150 m/min	
Output Pulse Duration	1..10s/ 1..60s adjustable	
Operating Temperature	-10°C..+50°C	
Storage Temperature	-10°C..+60°C	
Protection Class	IP20	
Housing Material	Polycarbonate (UL94V-0)	

10-CHANNEL CONTROL UNIT FOR FLAT SENSORS

The Control Unit provides 10 inputs and can analyse either several Flat Pack or RP Series sensors. If one of the connected sensors (max. 10) sends a signal it will be evaluated. With the outputs it is possible to e.g either activate an Alarm or stop the conveyor belt.

On the device there are buttons for "Start"/ "Stop". Two potentiometer inside of the control unit allow adjustments to the sensitivity of the Flat sensor.

Features

- Panel or DIN Rail Mount
- For Use with all Flat Pack and SP Series Sensors
- Universal Supply Voltage 110-250VAC
- Operation with 24VDC
- Transistor and Relay Output



Dimensions

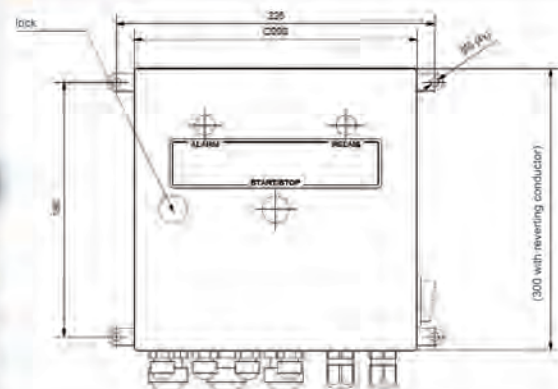

Technical Specifications

Part No. (Mounting)	8349005010 (Panel)	8349005012 (DIN RAIL)
Supply Voltage	110-250 VAC (50/60Hz), 24 VDC	
Sensor Supply	15VDC, max. 120mA (Overload and Short Circuit Protected)	
Transistor Output	1 x NPN, 1 x PNP, 20mA open collector	
Relay Output	1 x SPDT, max. 250 VAC, 5A	
Speed	1..10/ 1..30/1-100/1-150 m/min	
Output Pulse Duration	1..60s	
Operating Temperature	-10°C..+50°C	
Storage Temperature	-10°C..+60°C	
Protection Class	IP54/ IP20	
Housing Material	Steel	

FS SERIES MULTI-CHANNEL FLAT SENSORS

Altech FS Series Flat Sensors are high Sensitivity Flat Sensors which are not only detecting smallest metal pieces, they are also capable of localizing them. They are mainly used in Recycling Industry Applications. It allows the user to separate metallic particles precisely from other parts. It can be used on conveyor belts, slides or free-fall applications.



Features

- Various width available (50-2,000mm)
- Various resolutions, channel sizes (12.5-100mm)
- No Metal Free Zones necessary
- Stable and Shock proof Aluminum housing
- Interface fro PC or PLC
- Sensitivity adjustable via control unit

Technical Specifications

Electrical/ Supply Data	20..25VDC
Power consumption	10mA per channel
Connection	2m PVC cable (other on request)
Housing Material	Aluminum
Active Surface	POM
Dimensions	Width x 210 x 60.5mm
No. of Channels	4...160
Resolution (Channel Width)	12.5..120mm
Length	(No Channels +1) X Resolution

Environmental Data

Operating Temperature	-10°C..+60°C
Storage Temperature	-10°C..+70°C
Protection Class	IP65
Conveyor Speed	5...300m/min (16...984ft/min)

Control Unit

FS HMI	8310200003
--------	------------

Sensitivity

Channel size	12.5...19mm	50...120mm
FE Ball 4.5mm	24mm	30mm
FE Ball 3.0mm	15mm	20mm
FE Ball 2.5mm	11mm	14mm
FE Ball 2.0mm	7mm	8mm

* Sensitivity show max. distance between sensor and target.

ORDERING INFORMATION

Sensor Type	Resolution (mm)	No. Channels
AMD-FS2	35	12

Possible Configurations Examples

Resolution	No. Channels	Part No.
35mm	18	AMD-FS2-35-18
35mm	32	AMD-FS2-35-32
25mm	16	AMD-FS2-25-16
25mm	25	AMD-FS2-25-25
20mm	20	AMD-FS2-20-20
20mm	25	AMD-FS2-20-25

The Flat Sensor has a Dynamic working principle which allows it to detect moving metal objects. Non-moving objects will not be detected. However the dynamic principle allows it to operate with a much higher sensitivity. Even small metal targets can be detected. The sensor provides several channels in parallel. Each of them is equipped with its own sensor coil and evaluation board. Therefore the position of the object is also detectable. It can be controlled and adjusted by either a PC or separate control unit.

Dimensions

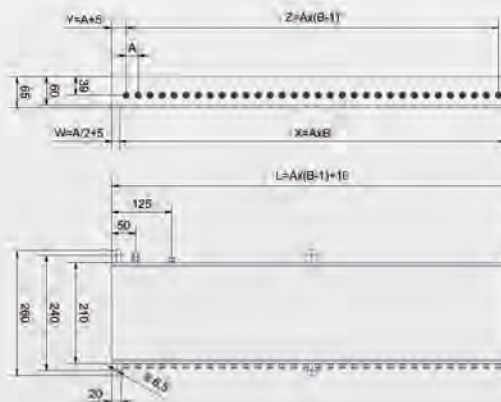

BD SERIES TUNNEL SENSORS

Altech BD Series Tunnel Sensors are used where highest detection capacities, sensitivity and reliability are needed. The user can choose between different control units depending on the complexity of his application. Applications include conveyors in the Plastic and Recycling Industry. The stainless steel housing also allows installation in the food industry. The unit is maintenance and calibration free.

Features

- Highest Sensitivity
- Custom Size (Height and Width)
- Stainless Steel Housing
- Different Control Units
- IP65

TECHNICAL SPECIFICATIONS

Sensor Opening - Height	50mm..750mm (25mm steps)
Sensor Opening - Width	100mm..1400mm (50mm steps)
Housing Material	Stainless Steel
Sensor Material Inside	Epoxy
Mounting	4 x threaded pin M12 x 45
Control Unit	Digital Plus or M-Pulse (Mounted directly to the Tunnel or up to 3m away)
Electrical Connection	Supply via Control Unit



Environmental Data

Operating Temperature	0°C..+50°C
Storage Temperature	-10°C..+50°C
Protection Class	IP65

POSSIBLE CONFIGURATIONS (EXAMPLES)

Part No.	Detection Height	Detection Width	Sensitivity		Dimension T	Dimension Z	Control Unit
			FE-Ball	Stainless Steel-Ball			
AMD-BD20075-DPLUS	75mm	200mm	0.7mm	1.4mm	280mm	100mm	Digital Plus
AMD-BD350100-DPLUS	100mm	350mm	0.8mm	1.8mm	280mm	100mm	Digital Plus
AMD-BD350100-MPULSE	100mm	350mm	0.8mm	1.8mm	280mm	100mm	M-Pulse
AMD-BD350150-DPLUS	150mm	350mm	1.0mm	2.0mm	280mm	100mm	Digital Plus
AMD-BD400200-DPLUS	200mm	400mm	1.2mm	2.2mm	330mm	120mm	Digital Plus
AMD-BD400200-MPULSE	200mm	400mm	1.2mm	2.2mm	330mm	120mm	M-Pulse
AMD-BD450250-DPLUS	250mm	450mm	1.5mm	2.5mm	330mm	120mm	Digital Plus
AMD-BD450250-MPULSE	250mm	450mm	1.5mm	2.5mm	330mm	120mm	M-Pulse
AMD-BD450300-DPLUS	300mm	450mm	1.6mm	2.8mm	380mm	140mm	Digital Plus
AMD-BD600350-DPLUS	350mm	600mm	2.0mm	2.8mm	380mm	160mm	Digital Plus
AMD-BD600350-MPULSE	350mm	600mm	2.0mm	2.8mm	380mm	160mm	M-Pulse
AMD-BD750400-DPLUS	400mm	750mm	3.0mm	4.0mm	430mm	180mm	Digital Plus

Dimensions

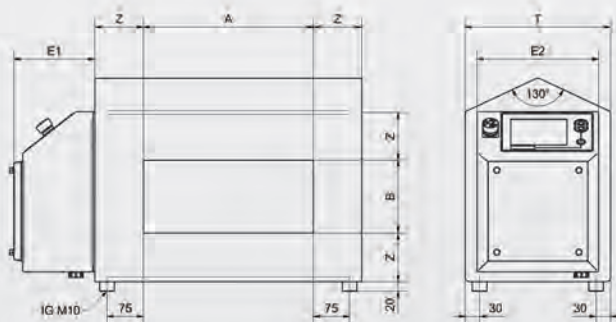

TU SERIES TUNNEL SENSORS

Altech TU Series Tunnel Sensors are used where highest detection capacities, sensitivity and reliability are needed. The user can choose between different control units depending on the complexity of his application. Applications include conveyors in the Plastic and Recycling Industry. The stainless steel housing also allows installation in the food industry. The unit is maintenance and calibration free.

The difference to the BD series is it is possible to be disassembled. It can be used on existing conveyors and machines which can't be disassembled. The Tunnel sensor can be divided into several modules and reassembled around existing machinery.

Features

- Possible to Disassemble
- Highest Sensitivity
- Custom Size (Height and Width)
- Stainless Steel Housing
- Different Control Units
- IP65

TECHNICAL SPECIFICATIONS

Active Sensor Opening - Height	100mm..800.. (50mm steps)
Active Sensor Opening - Width	300mm..2500mm (100mm steps)
Housing Material	Stainless Steel
Sensor Material Inside	Epoxy
Mounting	4 x Drill holes
Control Unit	Digital Plus or M-Pulse (Mounted directly to the Tunnel or up to 3m away)
Electrical Connection	Supply via Control Unit



Environmental Data

Operating Temperature	0°C..+50°C
Storage Temperature	-10°C..+50°C
Protection Class	IP54

POSSIBLE CONFIGURATIONS (EXAMPLES)

Part No.	Detection Height	Detection Width	Sensitivity		Dimension T	Dimension Z	Control Unit
			FE-Ball	Stainless Steel-Ball			
AMD-TU200200-DPLUS	200mm	200mm	2.5mm	4.0mm	500mm	110mm	Digital Plus
AMD-TU200200-MPULSE	200mm	200mm	2.5mm	4.0mm	500mm	110mm	M-Pulse
AMD-TU300300-DPLUS	300mm	300mm	3.0mm	5.0mm	500mm	110mm	Digital Plus
AMD-TU300300-MPULSE	300mm	300mm	3.0mm	5.0mm	500mm	110mm	M-Pulse
AMD-TU600400-DPLUS	400mm	600mm	3.5mm	6.0mm	500mm	110mm	Digital Plus
AMD-TU600400-MPULSE	400mm	600mm	3.5mm	6.0mm	500mm	110mm	M-Pulse
AMD-TU1000500-DPLUS	500mm	1000mm	7.0mm	9.0mm	500mm	110mm	Digital Plus
AMD-TU1000500-MPULSE	500mm	1000mm	7.0mm	9.0mm	500mm	110mm	M-Pulse
AMD-TU10001000-DPLUS	1000mm	1000mm	M16 Nut	M16 Nut	500mm	110mm	Digital Plus
AMD-TU10001000-MPULSE	1000mm	1000mm	M16 Nut	M16 Nut	500mm	110mm	M-Pulse

Dimensions

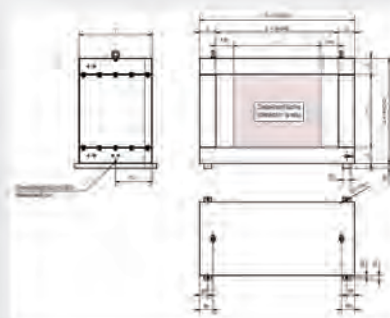

CONTROL UNIT ULTRA HIGH SENSITIVITY RING SENSORS

The Control Unit automatically controls and adjusts the connected sensor. This allows a maintenance-free operation. A32-Bit Processor System analyses the sensor data in realtime and filters out product effects and interferences. The device can be monitored via several In- and Outputs.

Features

- Stainless Steel Housing (IP65)
- Easy Handling and Operation
- High Sensitivity Application
- Fade-Out product Effect
- Maintenance Free operation

Technical Specifications

Part No.	included with AMD-RG Series
Supply Voltage	85-265 VAC, 50/60Hz
Power Consumption	max. 40W
Switching State	LED
Electrical Connection	3m connection cable (L1, N, Ground)
Digital I/O	
Digital Inputs	4
Digital Input Types	Optical isolated; VL= -5..-1.5V, VH= 6..50V; (Multifunction-Key, Ejector Guard)
Digital Outputs	6
Digital Output Types	PNP; max. 200mA (Transducer, Ejector, Device State)
Sensor - Transmitter	50 Ohm; Overload/ Short Circuit Proof (50..650kHz)
Sensor - Receiver	HDC-IQ - Receiver with Sensor-Readjustment
Serial Interfaces	2
Relay Output	2 SPDT; 250V, 1A
Voltage Output	24 VDC, Overload/ Short Circuit Proof; max. 2.5W for internal Components

Environmental Data

Operating Temperature	-10°C..+60°C
Storage Temperature	0°C..+50°C
Protection Class	IP65
Housing Material	Stainless Steel
Dimensions	200x300x80mm (7.9"x11.8"x3.2")
Weight	3000g (6.6lb)



Operation and Handling

Operation of the Control Unit is easy. The user can adjust the sensitivity and sets the parameters for various targets and their product effect. The parameters are set via the display and saved by pressing a button. Each saved product can be recalled by a single button. 3 LEDs signalize if there is a product loaded and which product it is.

The device is entirely maintenance-free. An integrated self-diagnosis tool immediately signalizes errors. All connections are pluggable.

Display

Keyboard	6 Keys (2 Selection Arrows, Enter, 3 x Keys for product)
Display	2 x 20 Characters, Backlit

Dimensions

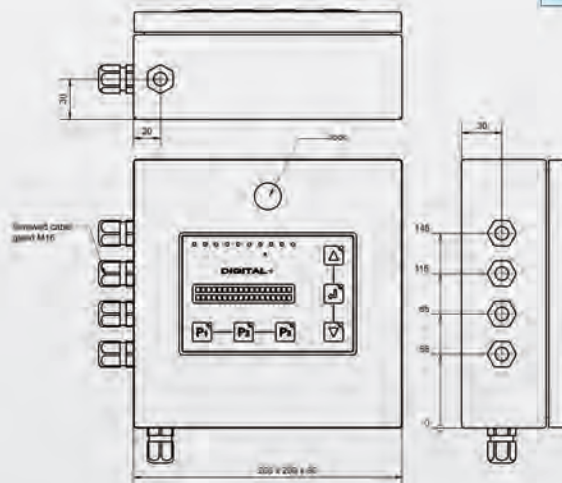

M-PULSE CONTROL UNIT

The Control Unit automatically controls and adjusts the connected sensor. This allows a maintenance-free operation. A32-Bit Processor System analyses the sensor data in realtime and filters out product effects and interferences. The device can be monitored via several In- and Outputs. Many additional Interfaces allow integration into other systems and machines.

Features

- Stainless Steel Housing (IP65)
- Easy Handling and Operation
- High Sensitivity Application
- Fade-Out product Effect
- Touchscreen Display
- HTTP Server for Remote Control and Updates
- Maintenance Free operation



Technical Specifications

Part No.	included with TU or BD Series Tunnel Sensors
Supply Voltage	85-265 VAC, 50/60Hz
Power Consumption	max. 40W
Switching State	LED
Electrical Connection	3m connection cable (L1, N, Ground)
Digital I/O	
Digital Inputs	4
Digital Input Types	Optical isolated; VL= -5..1.5V, VH= 6..50V; (Multifunction-Key, Ejector Guard)
Digital Outputs	6
Digital Output Types	PNP; max. 200mA (Transducer, Ejector, Device State)
Sensor - Transmitter	50 Ohm; Overload/ Short Circuit Proof (50..650kHz)
Sensor - Receiver	HDC-IQ - Receiver with Sensor-Readjustment
Serial Interfaces	2 x RS232
LAN	RJ45, Ethernet, 10/100 Mbit
Relay Output	2 SPDT; 250V, 1A
Voltage Output	24 VDC, Overload/ Short Circuit Proof; max. 2.5W for internal Components

Environmental Data

Operating Temperature	-10°C..+60°C
Storage Temperature	0°C..+50°C
Protection Class	IP65
Housing Material	Stainless Steel
Dimensions	250x330x160mm (9.8"x13.0"x6.3")
Weight	4600g (10.1lb)

Operation and Handling

The Touchscreen makes operation of the Control Unit very easy. The user can adjust the sensitivity and teaches in parameters for various targets and their product effect. The Effect can be taught in via the display and saved by pressing a button. The QuickLearn function allows also to save a product effect in one step. Each saved product can be recalled by a single button.

The device is entirely maintenance-free. An integrated self-diagnosis tool immediately signalizes errors. All connections are plug-gable.

Display

Display	320x240 TFT (65536 colors) Touchscreen
---------	----------------------------------------

Cat. No.	Page	Cat. No.	Page
8349005010	16	KJR-D100AN-DNIA-V2	9
8349005011	10	KJR-D100AN-DPA-V2	6
8349005012	16	KJR-D100AN-DPIA-V2	9
8349005013	10	KJR-D100FAN-DNA-V2	6
AMD-BD20075-DPLUS	18	KJR-D100FAN-DPA-V2	6
AMD-BD350100-DPLUS	18	KJR-D300AN-DNA-V2	7
AMD-BD350100-MPULSE	18	KJR-D300AN-DNIA-V2	9
AMD-BD350150-DPLUS	18	KJR-D300AN-DPA-V2	7
AMD-BD400200-DPLUS	18	KJR-D300AN-DPIA-V2	9
AMD-BD400200-MPULSE	18	KJR-D50AN-DNIA-V2	8
AMD-BD450250-DPLUS	18	KJR-D50AN-DPIA-V2	8
AMD-BD450250-MPULSE	18	KJR-D50FAN-DNA-V2	6
AMD-BD450300-DPLUS	18	KJR-D50FAN-DNA-V2	6
AMD-BD600350-DPLUS	18	KJR-D50FAN-DNIA-V2	8
AMD-BD600350-MPULSE	18	KJR-D50FAN-DPIA-V2	8
AMD-BD750400-DPLUS	18	KJR-D70AN-DNIA-V2	8
AMD-FS2-20-20	17	KJR-D70AN-DPIA-V2	8
AMD-FS2-20-25	17	M140	13
AMD-FS2-25-16	17	M140	14
AMD-FS2-25-25	17	M140-M240	14
AMD-FS2-35-18	17	M140-M240-M240	14
AMD-FS2-35-32	17	M140-M240-M240-M240	14
AMD-RG100-DPLUS	11	M140-M240-M240-M240-M240	14
AMD-RG25-DPLUS	11	M240	13
AMD-RG35-DPLUS	11	M240	14
AMD-RG50-DPLUS	11	M240-M240	14
AMD-RG70-DPLUS	11	M240-M240-M240	14
AMD-SP150	15	M240-M240-M240-M240	14
AMD-SP200	15	M240-M240-M240-M240-M240	14
AMD-SP250	15	M95	14
AMD-SP300	15	M95-M140-M240	14
AMD-SP350	15	M95-M140-M240-M240	14
AMD-SP400	15	M95-M140-M240-M240-M240	14
AMD-SP450	15	M95-M140-M240-M240-M240-M240	14
AMD-SP500	15	M95-M140-M240-M240-M240-M95	14
AMD-SPXXX	15	M95-M140-M240-M240-M95	14
AMD-TU10001000-DPLUS	19	M95-M140-M240-M95	14
AMD-TU10001000-MPULSE	19	M95-M140-M95	14
AMD-TU1000500-DPLUS	19	M95-M240	14
AMD-TU1000500-MPULSE	19	M95-M240-M240	14
AMD-TU200200-DPLUS	19	M95-M240-M240-M240	14
AMD-TU200200-MPULSE	19	M95-M240-M240-M240-M240	14
AMD-TU300300-DPLUS	19	M95-M240-M240-M240-M240-M95	14
AMD-TU300300-MPULSE	19	M95-M240-M240-M240-M95	14
AMD-TU600400-DPLUS	19	M95-M240-M240-M95	14
AMD-TU600400-MPULSE	19	M95-M240-M95	14
KJR-200AN-DNA-V2	7	M95-M95	14
KJR-200AN-DNIA-V2	9	M95L	13
KJR-200AN-DPA-V2	7	M95L	13
KJR-200AN-DPIA-V2	9		
KJR-D100AN-DNA-V2	6		

Circuit Protection Devices



Altech the market leader in UL508 Manual Motor Controllers/ Miniature Circuit Breakers now introduces UL489 Miniature Circuit Breakers and UL1077 Supplementary Protectors. The UL489 versions are DIN rail mounted, 17.5mm wide, thermal magnetic, 240V, 480Y/277V AC, 50/60Hz, 125 and 250 VDC models, with short circuit interrupt capacity of 10kA, a positive trip indicator, and are line/load reversible. The UL1077 versions are DIN rail mounted, 17.5mm wide, thermal magnetic, 480Y/277V AC, 50/60Hz, a short circuit withstand capacity 10kA, have a positive trip indicator.

Altech Corp.®
35 Royal Rd., Flemington, NJ 08822
908-806-9400
FAX 908-806-9490
www.altechcorp.com

Industrial Enclosures



Altech offers a broad selection of non-metallic and aluminum Industrial Enclosures to meet your diverse design requirements. Sizes range from 1.97 x 2.05 x 1.38 to 35.43 x 11.81 x 5.59 inches. Materials include polycarbonate, polystyrene, polypropylene, ABS or aluminum. Polycarbonate and aluminum series have been recently expanded. Protection up to IP67 (NEMA 4, 4X). Smooth sidewalls or sidewalls with knockouts. Enclosures can be mounted directly onto a panel, frame or other mounting surfaces. EMI / RFI Coating is available. Competitive cover printing is available. Hinge Kits. Customization available.

Altech Corp.®
35 Royal Rd., Flemington, NJ 08822
908-806-9400
FAX 908-806-9490
www.altechcorp.com

Smart Relays



Supports up to 48 I/Os (32 digital inputs & 16 digital outputs). DST Feature Available. Backlit LCD Screen for display & modification of pre-selected parameters of functional blocks, viewing I/O status and programming on the device. PC software for programming, online & offline simulation, documentation & printing. Designed for use in automation for commercial & Industrial sectors. Modbus Communication. UL 508 (UL File No. E352868), IEC 61000-3-2 and IEC 61000-4-2-1-11. 250 lines of ladder programming. 16 soft text messages, Time Switches, Compare Counters, Timers, Counters & 12 analog functions.

Altech Corp.®
35 Royal Rd., Flemington, NJ 08822
908-806-9400
www.altechcorp.com

Terminal Blocks



Altech offers a NEW Terminal Block catalog with the most competitively priced blocks in the industry. We feature screw and spring clamp models for DIN rail and panel mount applications. This advanced line of wire termination products will increase your design options and help to get the job done more efficiently. Our line of blocks include feed-through (single, double or triple level), distribution, ground, fuse, disconnect, thermocouple, surge suppressor and indicator. A wide variety of accessories, tools and ferrules are available.

Altech Corp.®
35 Royal Rd., Flemington, NJ 08822
908-806-9400
www.altechcorp.com

Motor Disconnect Switches



Altech's line of Motor Disconnect Switches are UL 508 listed as Manual Motor Controllers for AC Motor Starting Across-the-line and AC General use. This new 16 page catalog includes the 3 different handle designs, which are all available in gray/black or yellow/red housings. Electrical ratings are 25-150A / 600V. The switches are non-fused DIN Rail mountable. Neat features include: snap-on auxiliary switches, door mounting kit and a retrofit 30A fuse holder. Also featured are Enclosed Motor Disconnect Switches & Fused Enclosed Motor Disconnect Switch (30A) in plastic or stainless housings.

Altech Corp.®
35 Royal Rd., Flemington, NJ 08822
908-806-9400
www.altechcorp.com

Power Supplies



Altech DIN RAIL mountable power supplies have Universal AC input. They are suitable for industrial and automation applications. UL508 Listed or UL Recognized. Single and Three phases up to 960W. Outputs of 5V, 12V, 15V, 24V and 48V. Class 2 devices are available. Installed on DIN rail TS35/ 7.5 or 15. Protections of Short circuit / Overload / Overvoltage / Over temperature. Cooling by free air convection. All-In-One DC-UPS, battery based. Ultra Capacitor DC-UPS, no battery required. World-wide approvals. 3 year warranty.

Altech Corp.®
35 Royal Rd., Flemington, NJ 08822
908-806-9400
www.altechcorp.com

Altech Search

Google

Home Stock Check Distributors Information News Contact Rep/Dist Login Altech Mexico

WEB TOOLS

Product Crossings
Request for Quote
Sample Request
Catalog Request
eBook Catalog

PRODUCT MENU

ATEX Products
Circuit Protection / Control
Connectors
Enclosures
European Spare Parts
Digital Panel Meters
Foot Switches
Interface Modules
Panel Accessories
Power Supplies
Power Semi-Conductors
Programmable Controllers
Push Buttons & Pilot Lights
Relays
Safety Switches & Enclosures
Sensors
Suspension Systems
Terminal Blocks
Test & Measurement
Tower Lights
Timers
Wire & Cable Management
Home

New Products and Promotions

PROCESS EXPO

PROCESSING + PACKAGING

PROCESS EXPO

Altech Corp.® **BOOTH 5833**

THE GLOBAL FOOD EQUIPMENT & TECHNOLOGY SHOW
SEPTEMBER 15-18 • CHICAGO, ILLINOIS • MCCORMICK PLACE



NEW CLASS 2 COMPACT
Single Phase Power Supplies

CIRCUIT PROTECTION

 Circuit Protection Devices	 Busbar & Power Distribution	 Contactors, Overload Relays, Manual Motor Starters	 Motor Disconnect Switches	 European Fuses & Holders
---------------------------------------------------------------------------------------------------------------	----------------------------------------------------------------------------------------------------------------	---------------------------------------------------------------------------------------------------------------------------------------	----------------------------------------------------------------------------------------------------------------	---------------------------------------------------------------------------------------------------------------

CONNECTORS

 Pin & Sleeve Devices	 Receptacles	 Industrial Rectangular Connectors
----------------------------------------------------------------------------------------------------------	-------------------------------------------------------------------------------------------------	-----------------------------------------------------------------------------------------------------------------------

ENCLOSURES

 Industrial & ATEX Enclosures	 DIN Enclosures
-------------------------------------------------------------------------------------------------------------------	------------------------------------------------------------------------------------------------------

FOOT SWITCHES

 Industrial	 Medical
------------------------------------------------------------------------------------------------	---------------------------------------------------------------------------------------------

MODULES & RELAYS

 Interface Modules	 Safety Relays	 Industrial & Slimline Relays
-------------------------------------------------------------------------------------------------------	-----------------------------------------------------------------------------------------------------	--------------------------------------------------------------------------------------------------------------------

PANEL ACCESSORIES

 Panel Lights	 Heaters, Filters & Thermostats
--------------------------------------------------------------------------------------------------	--------------------------------------------------------------------------------------------------------------------

PARTS

 European Spare Parts

Pilot Devices

 22 & 30 mm Push Buttons & Enclosures	 Pilot Lights & E-Stops
---------------------------------------------------------------------------------------------------------------------------	--------------------------------------------------------------------------------------------------------------

POWER DEVICES

 Power Supplies	 DC-UPS & Battery Chargers
----------------------------------------------------------------------------------------------------	---------------------------------------------------------------------------------------------------------------

POWER MANAGEMENT

 Altech Smart Relays	 Digital Panel Meters	 Digital Timers
---------------------------------------------------------------------------------------------------------	------------------------------------------------------------------------------------------------------------	------------------------------------------------------------------------------------------------------

Altech Corporation
35 Royal Road
Flemington, NJ 08822-6000
P 908.806.9400 • F 908.806.9490
www.altechcorp.com
Altech Corp.© 270R-092015-2K
Printed September 2015

