



User Manual

IDS-3210 Series

**10.4" Industrial Panel Mount
Monitor**

ADVANTECH

Enabling an Intelligent Planet

Copyright

The documentation and the software included with this product are copyrighted 2019 by Advantech Co., Ltd. All rights are reserved. Advantech Co., Ltd. reserves the right to make improvements in the products described in this manual at any time without notice. No part of this manual may be reproduced, copied, translated or transmitted in any form or by any means without the prior written permission of Advantech Co., Ltd. Information provided in this manual is intended to be accurate and reliable. However, Advantech Co., Ltd. assumes no responsibility for its use, nor for any infringements of the rights of third parties, which may result from its use.

Acknowledgements

Intel and Pentium are trademarks of Intel Corporation.

Microsoft Windows and MS-DOS are registered trademarks of Microsoft Corp.

All other product names or trademarks are properties of their respective owners.

Product Warranty (2 years)

Advantech warrants to you, the original purchaser, that each of its products will be free from defects in materials and workmanship for two years from the date of purchase.

This warranty does not apply to any products which have been repaired or altered by persons other than repair personnel authorized by Advantech, or which have been subject to misuse, abuse, accident or improper installation. Advantech assumes no liability under the terms of this warranty as a consequence of such events.

Because of Advantech's high quality-control standards and rigorous testing, most of our customers never need to use our repair service. If an Advantech product is defective, it will be repaired or replaced at no charge during the warranty period. For out-of-warranty repairs, you will be billed according to the cost of replacement materials, service time and freight. Please consult your dealer for more details.

If you think you have a defective product, follow these steps:

1. Collect all the information about the problem encountered. (For example, CPU speed, Advantech products used, other hardware and software used, etc.) Note anything abnormal and list any onscreen messages you get when the problem occurs.
2. Call your dealer and describe the problem. Please have your manual, product, and any helpful information readily available.
3. If your product is diagnosed as defective, obtain an RMA (return merchandise authorization) number from your dealer. This allows us to process your return more quickly.
4. Carefully pack the defective product, a fully-completed Repair and Replacement Order Card and a photocopy proof of purchase date (such as your sales receipt) in a shippable container. A product returned without proof of the purchase date is not eligible for warranty service.
5. Write the RMA number visibly on the outside of the package and ship it prepaid to your dealer.

Declaration of Conformity

CE

This product has passed the CE test for environmental specifications. Test conditions for passing included the equipment being operated within an industrial enclosure. In order to protect the product from being damaged by ESD (Electrostatic Discharge) and EMI leakage, we strongly recommend the use of CE-compliant industrial enclosure products.

FCC Class A

Note: This equipment has been tested and found to comply with the limits for a Class A digital device, pursuant to part 15 of the FCC Rules. These limits are designed to provide reasonable protection against harmful interference when the equipment is operated in a commercial environment. This equipment generates, uses, and can radiate radio frequency energy and, if not installed and used in accordance with the instruction manual, may cause harmful interference to radio communications. Operation of this equipment in a residential area is likely to cause harmful interference in which case the user will be required to correct the interference at his own expense.

FM

This equipment has passed the FM certification. According to the National Fire Protection Association, work sites are classified into different classes, divisions and groups, based on hazard considerations. This equipment is compliant with the specifications of Class I, Division 2, Groups A, B, C and D indoor hazards.

Technical Support and Assistance

1. Visit the Advantech website at <http://support.advantech.com> where you can find the latest information about the product.
2. Contact your distributor, sales representative, or Advantech's customer service center for technical support if you need additional assistance. Please have the following information ready before you call:
 - Product name and serial number
 - Description of your peripheral attachments
 - Description of your software (operating system, version, application software, etc.)
 - A complete description of the problem
 - The exact wording of any error messages

Warnings, Cautions and Notes

Warning! *Warnings indicate conditions, which if not observed, can cause personal injury!*



Caution! *Cautions are included to help you avoid damaging hardware or losing data. e.g.*



There is a danger of a new battery exploding if it is incorrectly installed. Do not attempt to recharge, force open, or heat the battery. Replace the battery only with the same or equivalent type recommended by the manufacturer. Discard used batteries according to the manufacturer's instructions.

Note! *Notes provide optional additional information.*



Document Feedback

To assist us in making improvements to this manual, we would welcome comments and constructive criticism. Please send all such, in writing, to: support@advan-tech.com

Safety Instructions

1. Read these safety instructions carefully.
2. Keep this User Manual for later reference.
3. Disconnect this equipment from any AC outlet before cleaning. Use a damp cloth. Do not use liquid or spray detergents for cleaning.
4. For plug-in equipment, the power outlet socket must be located near the equipment and must be easily accessible.
5. Keep this equipment away from humidity.
6. Put this equipment on a reliable surface during installation. Dropping it or letting it fall may cause damage.
7. The openings on the enclosure are for air convection. Protect the equipment from overheating. **DO NOT COVER THE OPENINGS.**
8. Make sure the voltage of the power source is correct before connecting the equipment to the power outlet.
9. Position the power cord so that people cannot step on it. Do not place anything over the power cord.
10. All cautions and warnings on the equipment should be noted.
11. If the equipment is not used for a long time, disconnect it from the power source to avoid damage by transient overvoltage.
12. Never pour any liquid into an opening. This may cause fire or electrical shock.
13. Never open the equipment. For safety reasons, the equipment should be opened only by qualified service personnel.
14. If one of the following situations arises, get the equipment checked by service personnel:
 - The power cord or plug is damaged.
 - Liquid has penetrated into the equipment.
 - The equipment has been exposed to moisture.
 - The equipment does not work well, or you cannot get it to work according to the user's manual.
 - The equipment has been dropped and damaged.
 - The equipment has obvious signs of breakage.
15. **DO NOT LEAVE THIS EQUIPMENT IN AN ENVIRONMENT WHERE THE STORAGE TEMPERATURE MAY GO BELOW -20° C (-4° F) OR ABOVE 60° C (140° F). THIS COULD DAMAGE THE EQUIPMENT. THE EQUIPMENT SHOULD BE IN A CONTROLLED ENVIRONMENT.**
16. **CAUTION: DANGER OF EXPLOSION IF BATTERY IS INCORRECTLY REPLACED. REPLACE ONLY WITH THE SAME OR EQUIVALENT TYPE RECOMMENDED BY THE MANUFACTURER, DISCARD USED BATTERIES ACCORDING TO THE MANUFACTURER'S INSTRUCTIONS.**

The sound pressure level at the operator's position according to IEC 704-1:1982 is no more than 70 dB (A).

DISCLAIMER: This set of instructions is given according to IEC 704-1. Advantech disclaims all responsibility for the accuracy of any statements contained herein.

Caution! *For power adapter selection: the information about the adapter output rating (12 Vdc, 3 A min) is provided in the user manual for user's selection if the power adapter is not shipped with the unit*



Contents

Chapter 1	Overview.....	1
1.1	Introduction	2
1.2	Features	2
1.3	Applications.....	2
1.4	Product Photos.....	3
1.5	Naming Rule	4
Chapter 2	System Setup.....	5
2.1	Specifications	6
2.2	Dimensions	8
	Figure 2.1 IDS-3210 Series Dimensions	8
	Figure 2.2 IDS-3210E Series Dimensions	8
	Figure 2.3 IDS-3210 XGA Series with Resistive Touch Screen / Glass	8
	Figure 2.4 IDS-3210 XGA Series with P-Cap Touch Screen.....	9
2.3	Rear Mount Assembly SOP	10
2.4	Cable Clamp	10
2.5	Packing List.....	11
Chapter 3	Touchscreen	13
3.1	OSD Functions (IDS-3210 Series).....	14
	3.1.1 OSD Main Menu: Push the MENU Key	14
	3.1.2 Brightness Selection - Submenu.....	15
	3.1.3 Contrast Control.....	15
	3.1.4 Screen Settings - Submenu	15
	3.1.5 Color Temperature - Submenu	16
	3.1.6 Language - Submenu	16
	3.1.7 OSD Setting - Submenu	17
	3.1.8 VGA/DVI Selection.....	17
3.2	OSD Functions for IDS-3210E Series.....	18
	3.2.1 OSD Main Menu: Push the MENU Key	18
	3.2.2 OSD Lock.....	18
	3.2.3 OSD Unlock	18
	3.2.4 Color Adjustment - Submenu (Brightness /Contrast/ Color Adjust/ Color Temp/Auto Color).....	19
	3.2.5 Image Setting Adjustment.....	19
	3.2.6 Image Adjustment -Submenu (Clock/Phase/H. Position/V. Position)	20
	3.2.7 OSD Menu Adjustment	20
	3.2.8 OSD Adjustment - Submenu (OSD H.Pos./ OSD V.Pos./OSD Timer).....	21
	3.2.9 OSD Adjustment - Language Submenu.....	21
	3.2.10 Reset Adjustment.....	22
3.3	OSD Functions for IDS-3210 XGA series	23
	3.3.1 OSD Menu Details	23
3.4	Touch Drivers.....	31
Appendix A	Troubleshooting	33
A.1	Introduction	34

A.2	Troubleshooting	34
-----	-----------------------	----

Chapter 1

Overview

Sections Include:

- Introduction
- Features
- Applications
- Product Photos
- Naming Rule

1.1 Introduction

The Advantech IDS-3210 series is a brand new Industrial Panel Mount Monitor, designed to meet the needs of customers who want quick and easy integration with Advantech Embedded Box Computers, such as ARK and DSA lines. Advantech offers two different versions of IDS-3210 to meet different demands: IDS-3210 series (Superior grade version) and IDS-3210E series (Economical version)

1.2 Features

- 10.4" SVGA and XGA LED backlight panel provides 20 ~ 30% power saving
- -20°C ~ +60°C wide operating temperature support
- 5-wire resistive and P-cap touchscreen solution or tempered smudge resistant protected glass
- Combo Touch interface: RS-232 and USB
- Dual signal interface with VGA and DVI
- Standard integrated frame
- Versatile mounting methods for rear mount and VESA mount (75 x 75 mm, 100 x 100 mm)

1.3 Applications

Application scenarios - self-service applications:

- KIOSK / POI machine
- Transportation machine
- Ticketing machine
- Financial ATM
- Entertainment / Gaming / Slot machine
- HMI (Human-Machine Interface) equipment controller monitor
- Public communication machine
- Public advertisement machine

1.4 Product Photos

Front View



Rear View

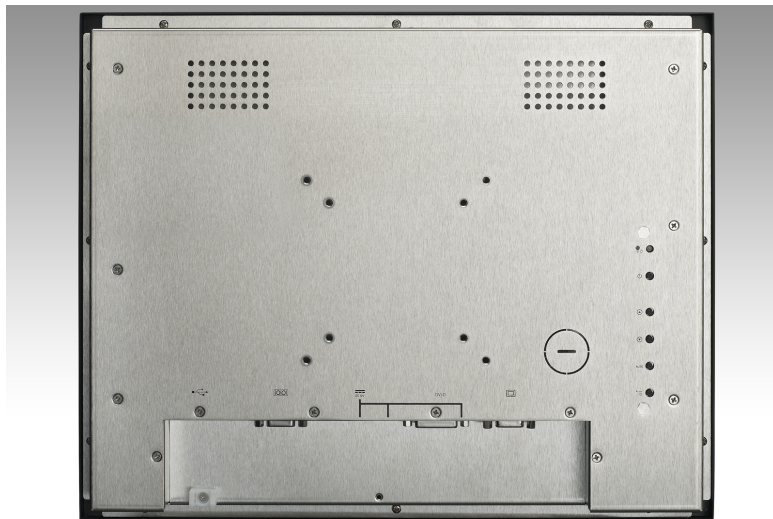

IDS-3210 Bottom View



IDS-3210E Bottom View



1.5 Naming Rule

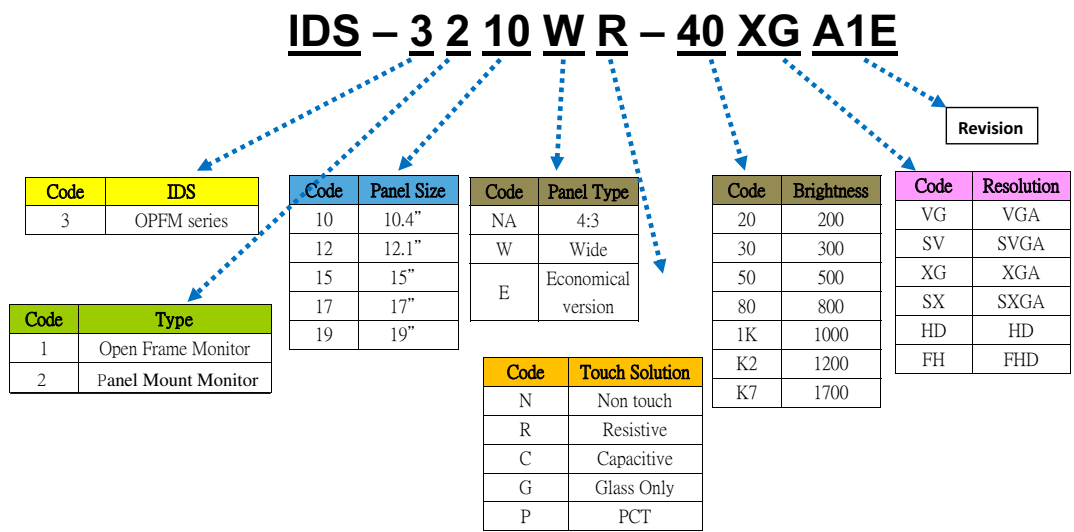

Chapter 2

System Setup

Sections Include:

- Specifications
- Dimensions
- Rear Mount Assembly SOP
- Cable Clamp
- Accessory Packing

2.1 Specifications

Note! The IDS-3210 series offers the following features and meets precise specifications.



Unless otherwise noted, all the information listed below is subject to change without prior notification.

	Model	IDS-3210	IDS-3210E	IDS-3210 XGA
Display	Size	10.4" LED panel	10.4" LED panel	10.4" LED panel
	Resolution	800 x 600 (SVGA)	800 x 600 (SVGA)	1024 x 768 (XGA)
	Viewing Angle	80° /80° (H), 60° /80° (V)	80° /80° (H), 60° /70° (V)	88° /88° (H), 88° /88° (V)
	Brightness	400 (cd/m ²)	230 (cd/m ²)	500 (cd/m ²)
	Color Support	16.2 M / 262 K colors	16.2 M / 262 K colors	16.2 M colors
	Contrast Ratio	700:1	500:1	1000:1
	Response Time	30 [msec]	35 [msec]	25 [msec]
	Backlight Life	50,000 hrs	30,000 hrs	50,000 hrs
Touchscreen	Touchscreen Type	5-Wire Resistive Touchscreen		5-Wire Resistive / P-cap
	Surface Hardness	3H		3H / Mohs 5
	Durability	36 million touches		36 million touches / -
	Transparency	82%±3%		82% / 90%
Environment	Operating Temperature	-20 ~ 60° C (-4 ~ 140° F)	0~ 45° C (32 ~ 113° F)	-20 ~ 60° C (-4 ~ 140° F)
	Storage Temperature	-30 ~ 70° C (-22 ~ 158° F)	-20 ~ 60° C (-4 ~ 140° F)	-30 ~ 70° C (-22 ~ 158° F)
	Humidity	10 ~ 90% @ 40 °C, non-condensing		

	I/O	VGA x 1; DVI-D x 1; 12 VDC Jack x 1; USB x1; RS-232 x 1 (USB & RS-232 are reserved for the connection to enable touch usage only)	VGA x 1; 12 VDC Jack x 1; USB x1; RS-232 x 1 (USB & RS-232 are reserved for the connection to enable touch usage only)	VGA x 1; DVI-D x 1; 12 VDC Jack x 1; USB x1; RS-232 x 1 (USB & RS-232 are reserved for the connection to enable touch usage only)
System	OSD	Keys: menu, up, down, auto adjust, monitor power on/off Menu Functions: brightness, contrast, screen settings, color temp, language OSD settings, VGA/DVI, recall, auto adjust	Keys: menu, up, down, auto adjust, monitor power on/off Menu Functions: brightness, contrast, color adjust, color temp, auto color and language	Keys: menu, up, down, auto adjust, monitor power on/off Menu Functions: brightness, contrast, screen settings, color temp, language OSD settings, VGA/DVI, recall, auto adjust
	Power	36 W power adapter, with AC 100 ~ 240 V input and DC +12 V @ 3 A output		
	EMC Compliance	CE/FCC/CCC		

2.2 Dimensions

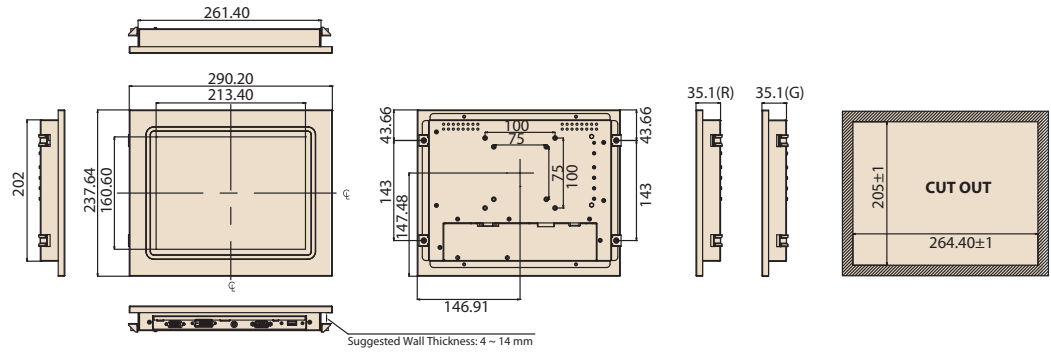

Figure 2.1 IDS-3210 Series Dimensions

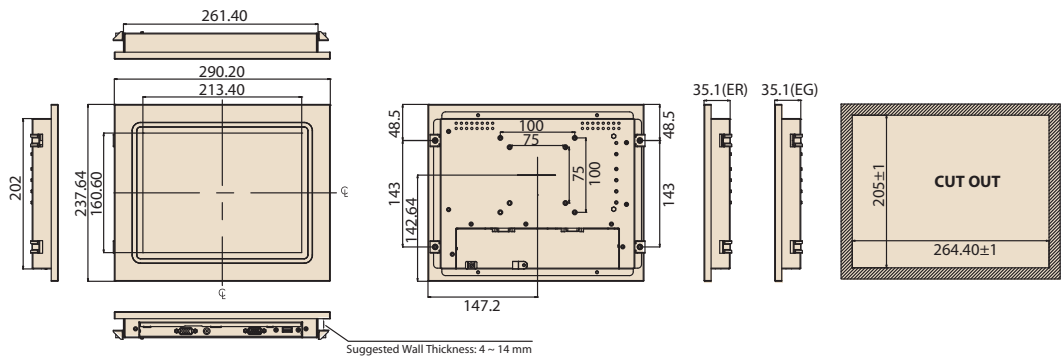

Figure 2.2 IDS-3210E Series Dimensions

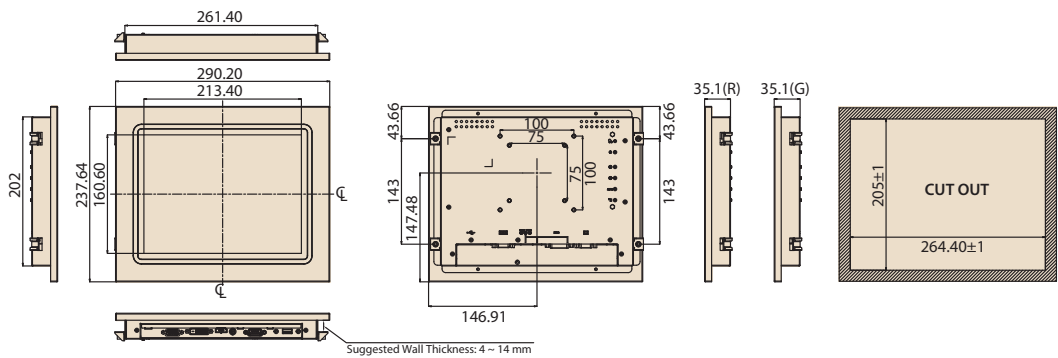

Figure 2.3 IDS-3210 XGA Series with Resistive Touch Screen / Glass

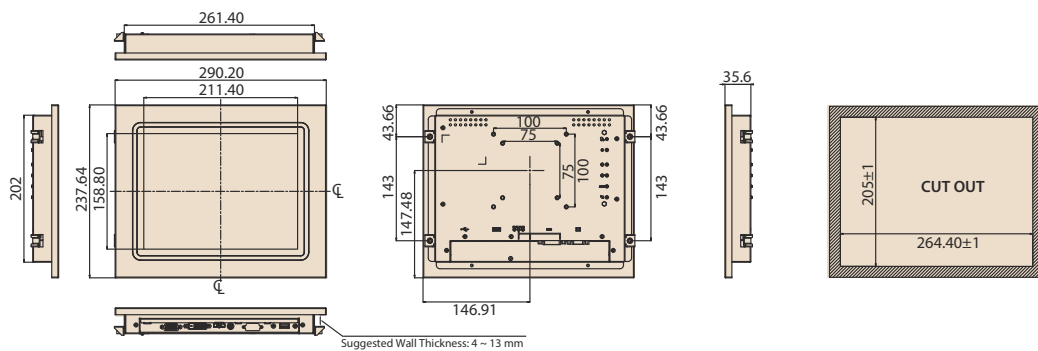
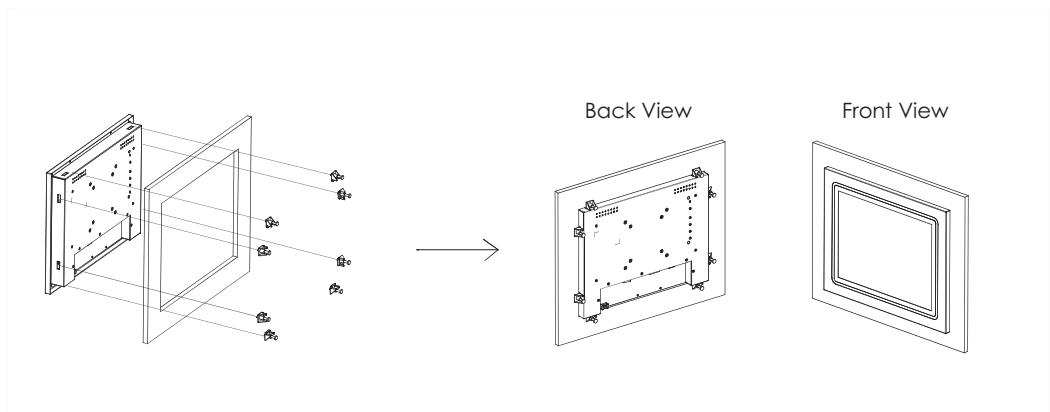

Figure 2.4 IDS-3210 XGA Series with P-Cap Touch Screen

2.3 Rear Mount Assembly SOP

1. Using the M4 25L screw and panel mount clamp to attach and tighten as shown in the below figure.



2.4 Cable Clamp

1. A cable clamp also comes with Open Frame Monitor to fix the power cable, see picture below.

Cable Clamp with IDS-3210 Series

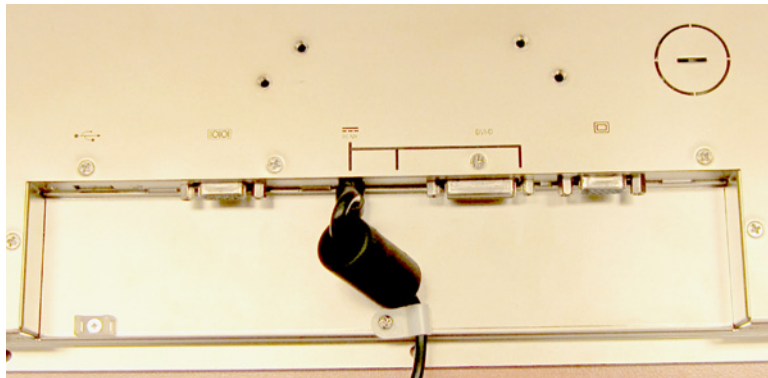

2. A cable tie for the USB cable is included in the accessory box, see below:

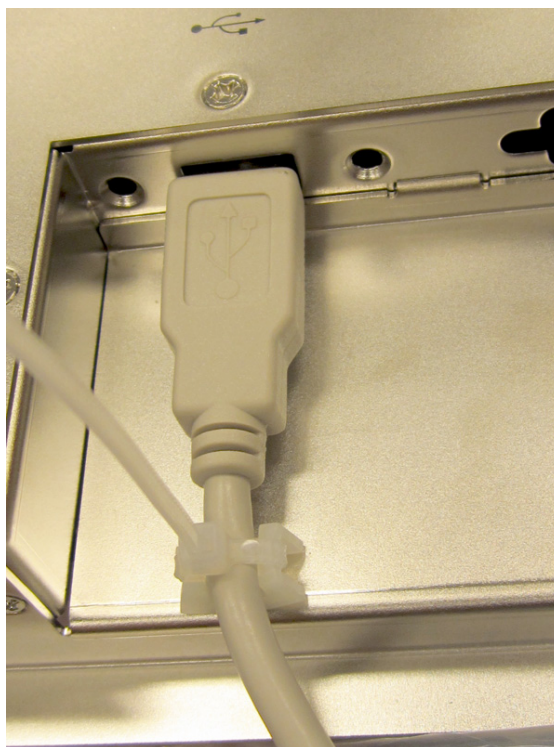

2.5 Packing List

- 1 x VGA cable 15P(M) 1.8 meter
- 1 x USB-A(M)/USB-A(M) 1.8 meter (only for models with touch screen)
- 4 x Panel-mount clamps
- 4 x Panel-mount clamping screws: M4_25L
- 1 x Cable clamp
- 1 x Cable clamp screw
- 1 x Cable tie

Note! Above accessory cables are subject to change in different SKUs.



Chapter 3

Touchscreen

Sections Include:

- OSD Functions
- Touch Drivers

3.1 OSD Functions (IDS-3210 Series)

The OSD of the IDS-3210 display (800 x 600 resolution) was selected to illustrate examples below:

Buttons	Description
Power	Turn the monitor power ON or OFF
Menu	Activate the OSD menu Exit menu
Auto	Automatically adjust the clock , phase , H-position and V-position
Value Up/Down	Move the selector to the previous option Decrease the gauge value of the selected option

LED Function	
DPMS ON	Green
DPMS STANDBY	Orange
DPMS OFF	Red

3.1.1 OSD Main Menu: Push the MENU Key



3.1.2 Brightness Selection - Submenu



3.1.3 Contrast Control

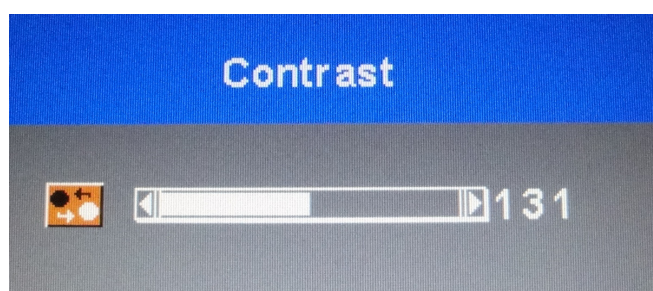

3.1.4 Screen Settings - Submenu

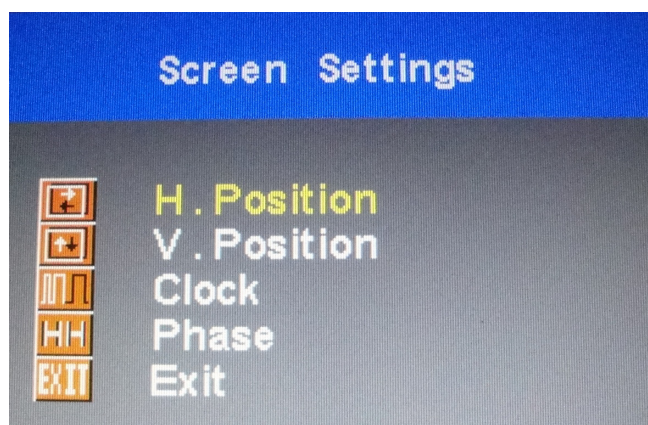

3.1.5 Color Temperature - Submenu



3.1.6 Language - Submenu



3.1.7 OSD Setting - Submenu

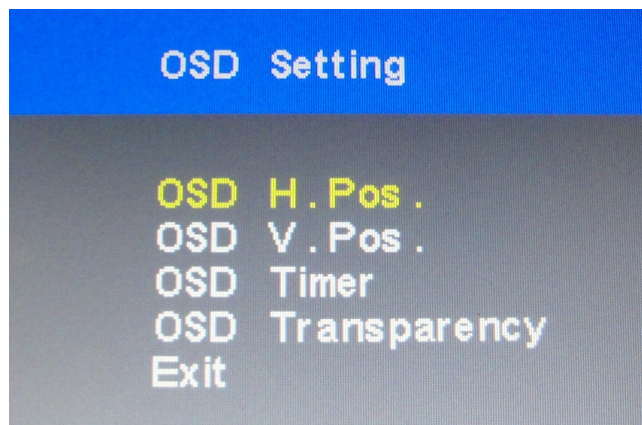

3.1.8 VGA/DVI Selection

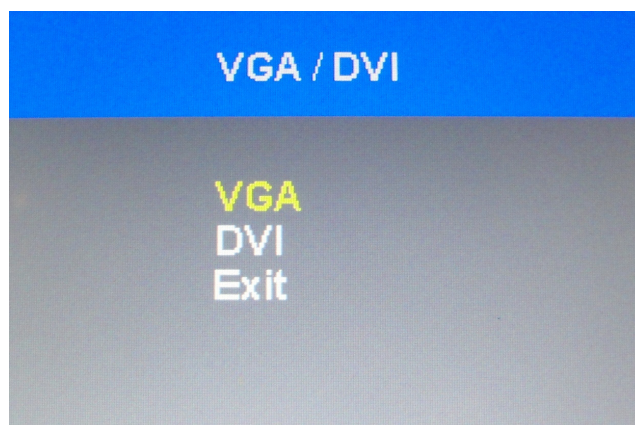

3.2 OSD Functions for IDS-3210E Series

3.2.1 OSD Main Menu: Push the MENU Key

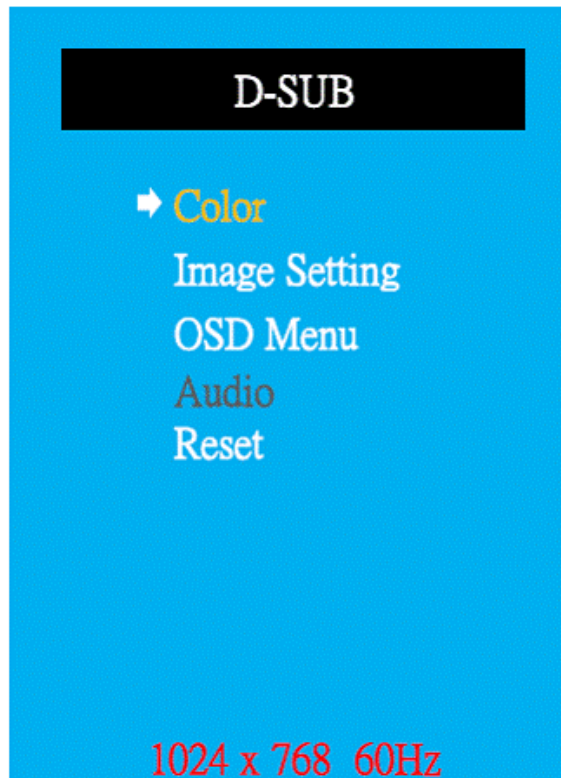

3.2.2 OSD Lock

Press the "Right" key and "Menu" key simultaneously to lock the OSD key.



3.2.3 OSD Unlock

Press the "Right" key and "Menu" key simultaneously again to unlock the OSD key.



3.2.4 Color Adjustment - Submenu (Brightness /Contrast/ Color Adjust/Color Temp/Auto Color)

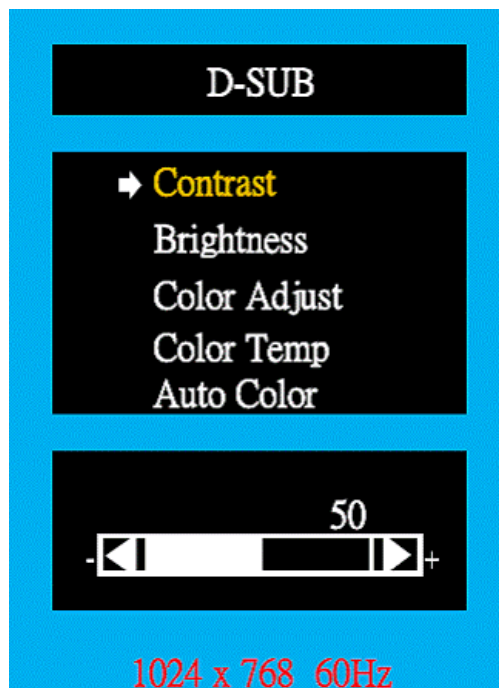

3.2.5 Image Setting Adjustment

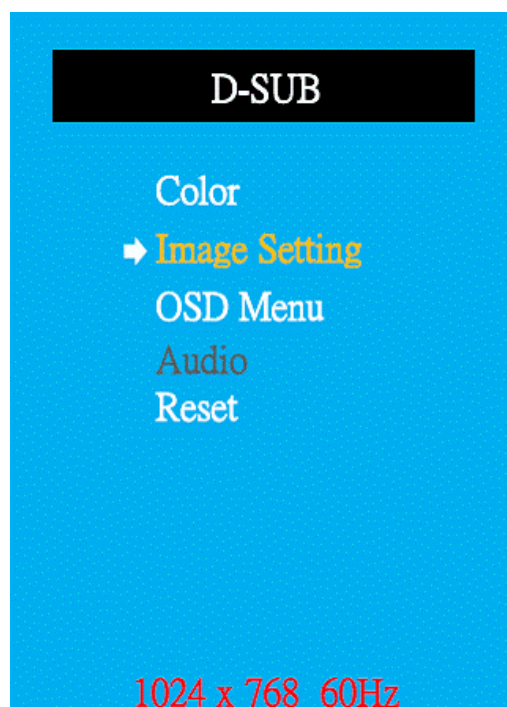

3.2.6 Image Adjustment -Submenu (Clock/Phase/H. Position/V. Position)

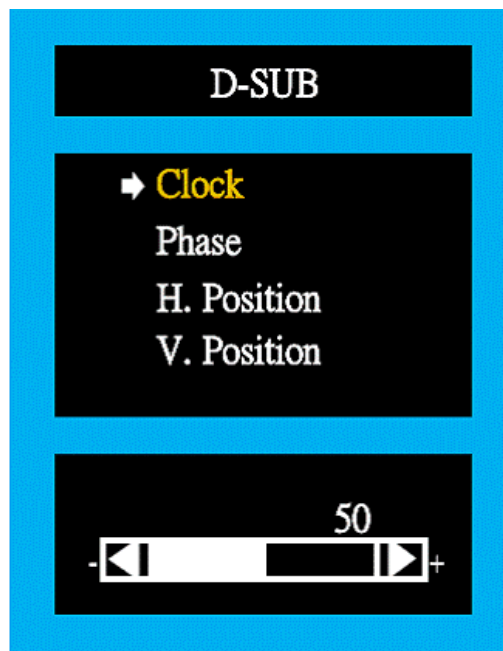

3.2.7 OSD Menu Adjustment

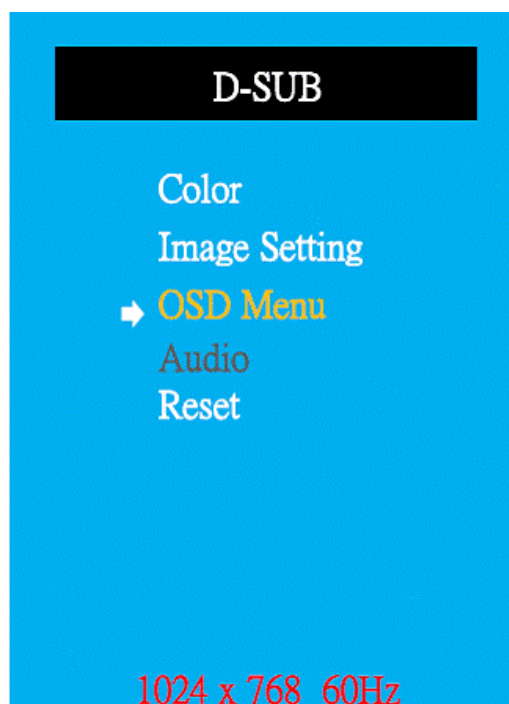

3.2.8 OSD Adjustment - Submenu (OSD H.Pos./ OSD V.Pos./OSD Timer)



3.2.9 OSD Adjustment - Language Submenu



3.2.10 Reset Adjustment

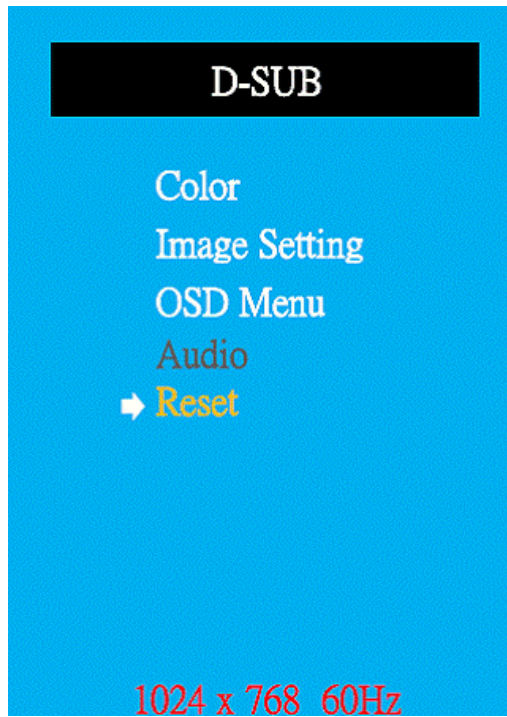

3.3 OSD Functions for IDS-3210 XGA series

IDS-3210 XGA series are equipped with 1024 x 768 display resolution and the following OSD features:

Buttons	Description
Power	Turn the monitor power ON or OFF
Menu	Activate the OSD menu Select
Auto/Exit	Automatically adjust the clock, phase H-position and V-position
Value Up/Down	Move the selector to the previous option Reduce the value of the selected option

LED Function	
DPMS ON	Green
DPMS STANDBY	Orange
DPMS OFF	Red

Hot Key	Function
Value Down	ECO mode

3.3.1 OSD Menu Details

3.3.1.1 Luminance

Contrast

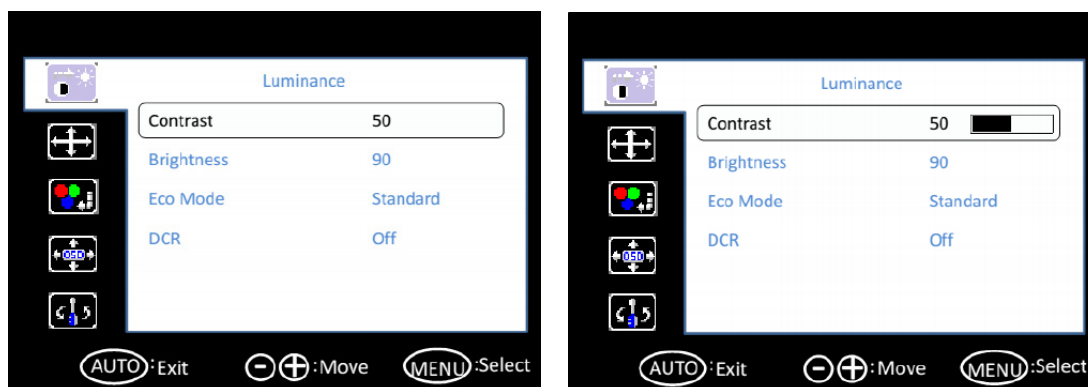

Brightness



Eco Mode

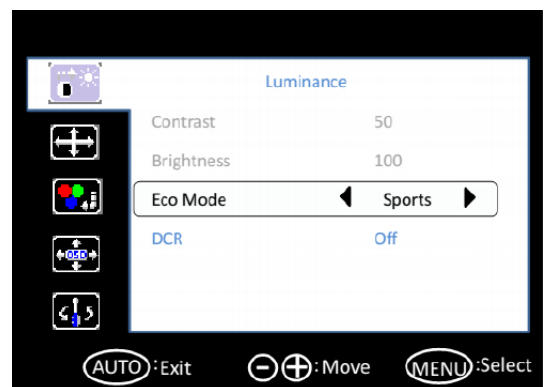
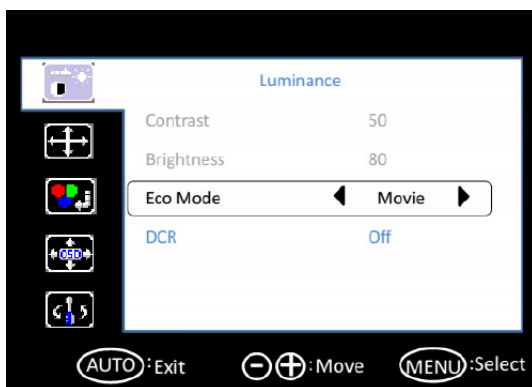
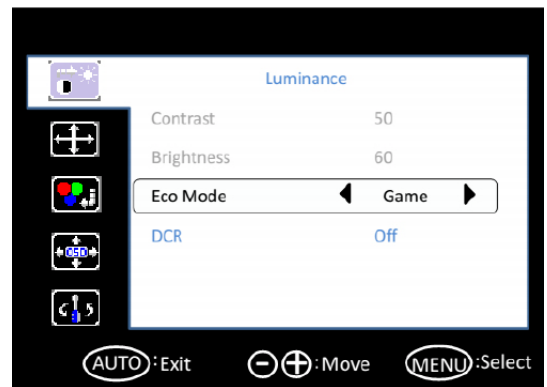
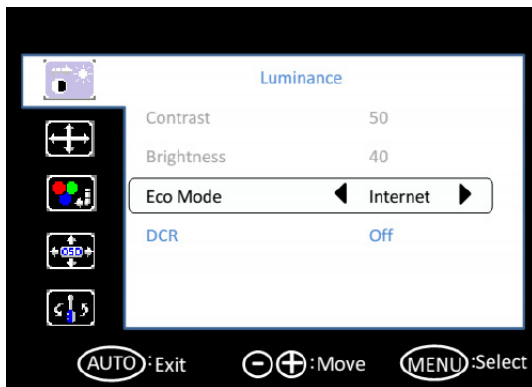
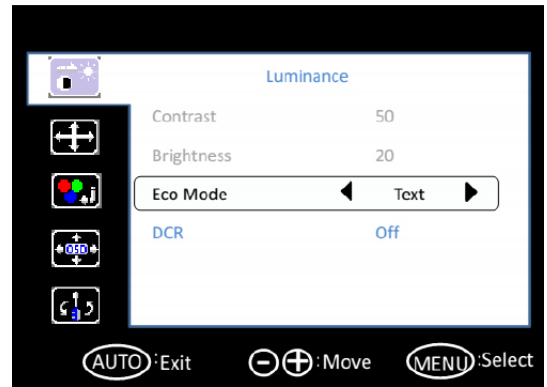
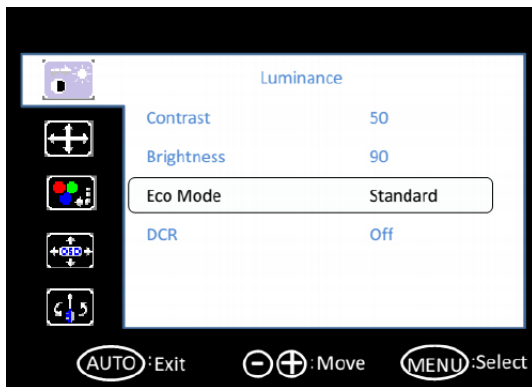

DCR

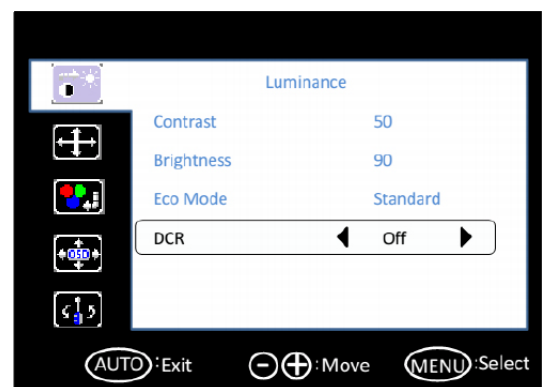
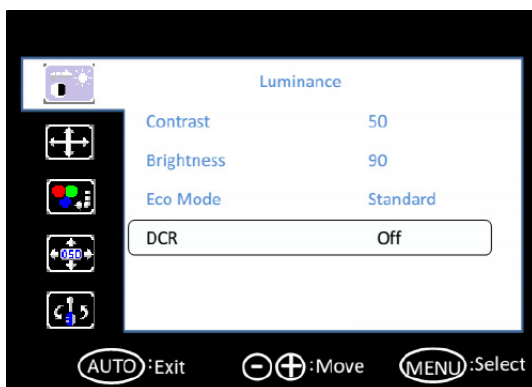

3.3.1.2 Image Setup

Clock

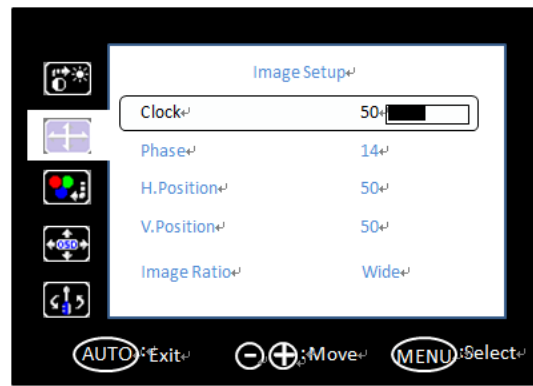
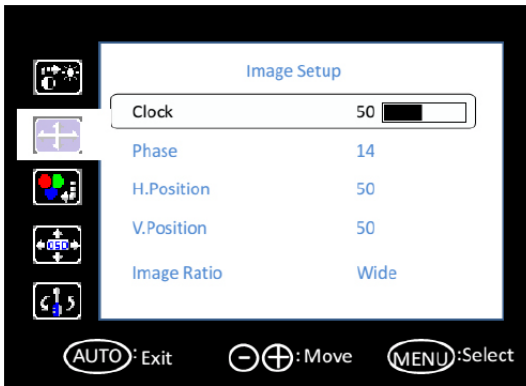

Phase

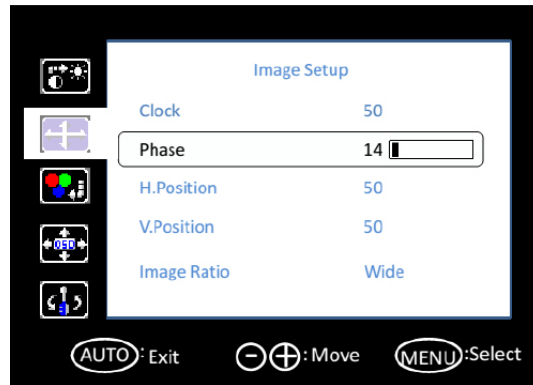
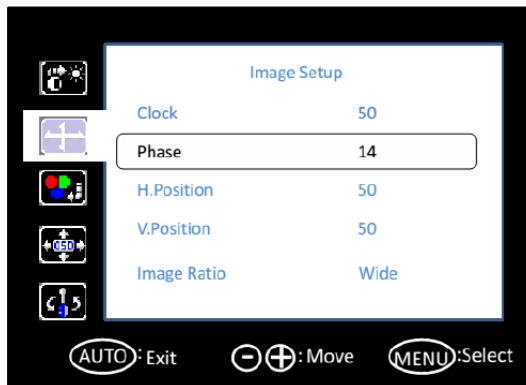

H. Position

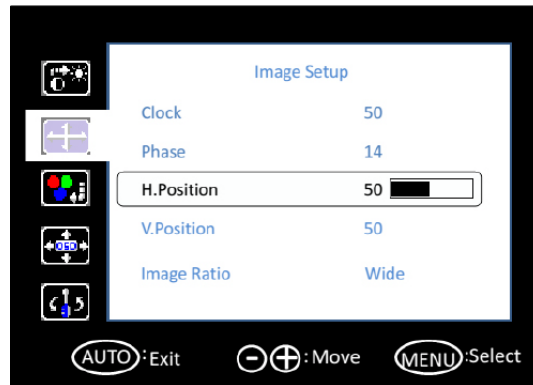
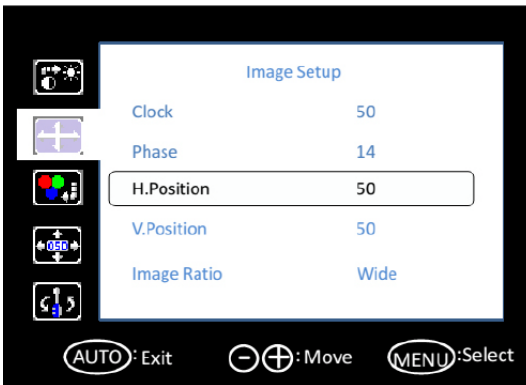

V. Position

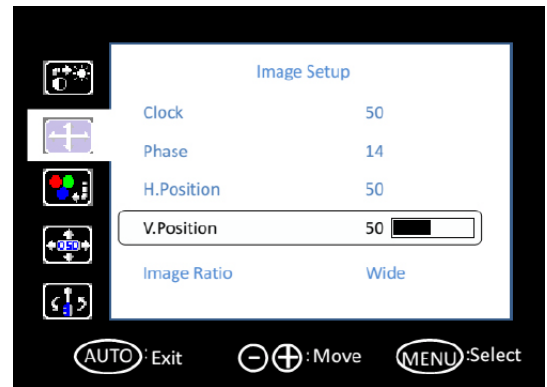
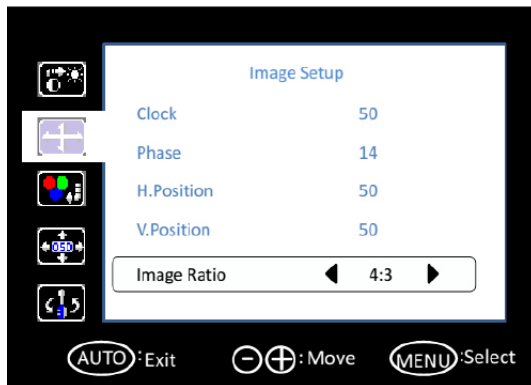
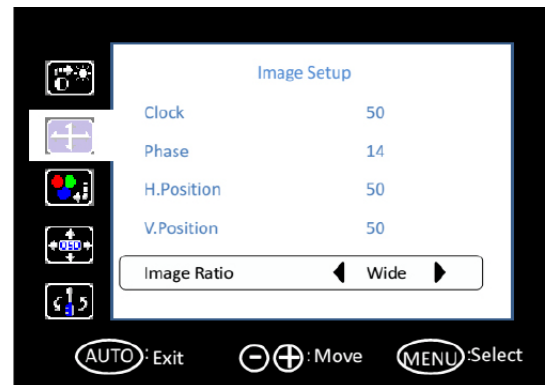
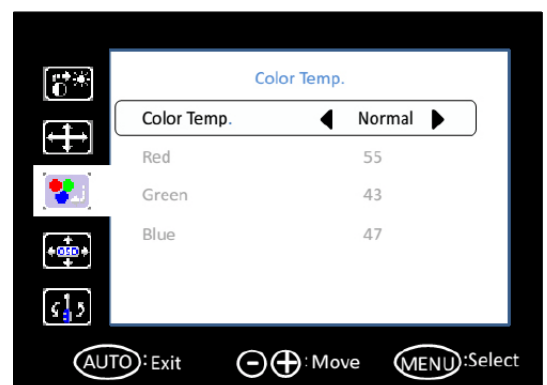
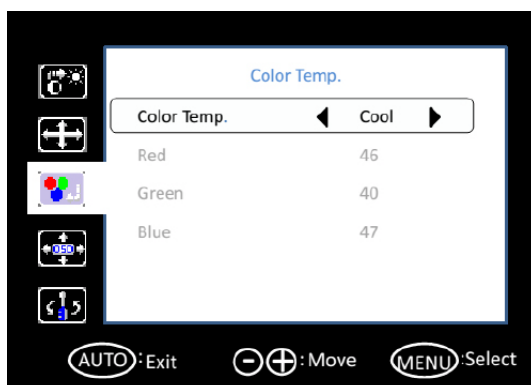
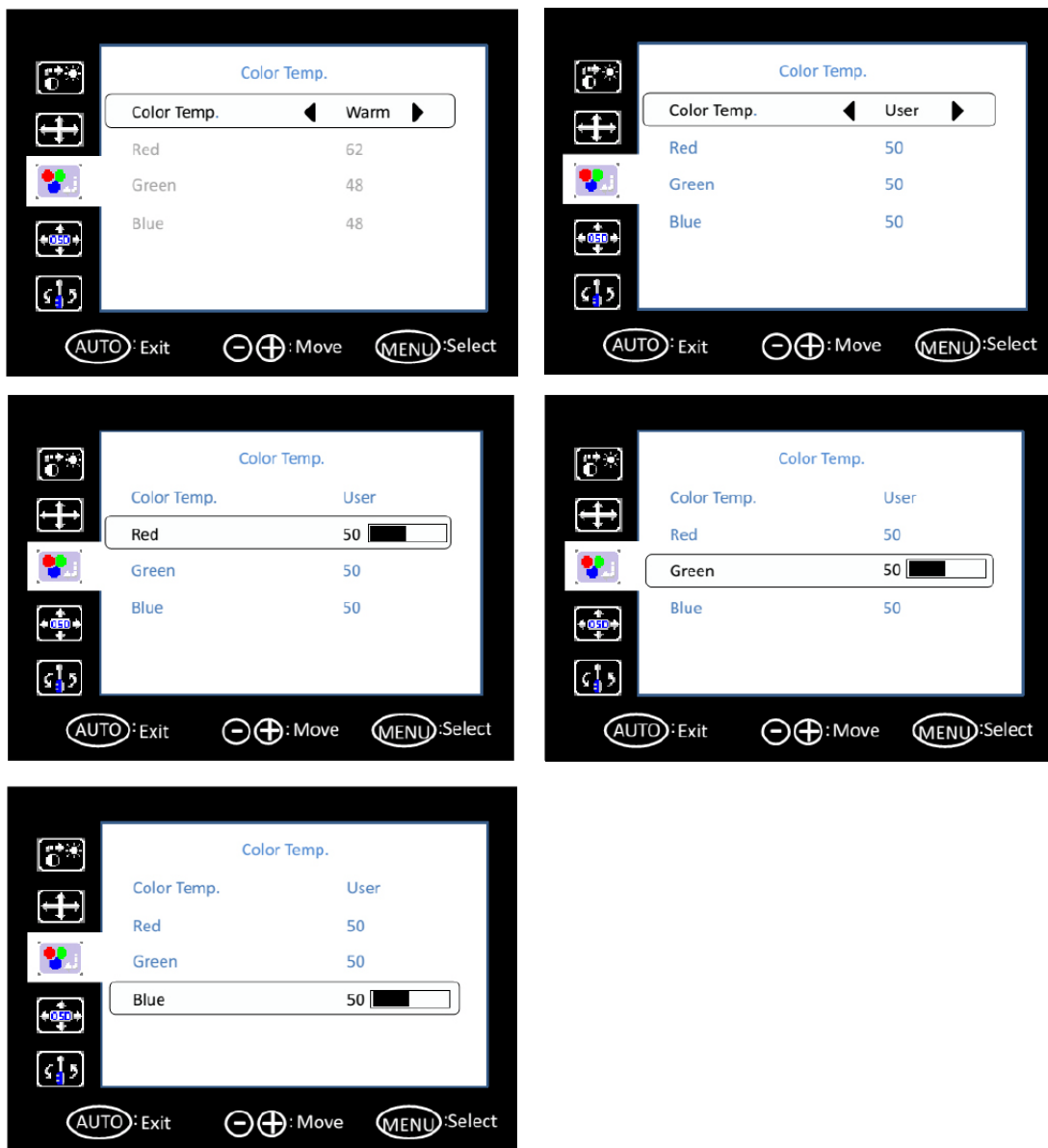

Image Ratio



3.3.1.3 Color Temperature





3.3.1.4 OSD Setup

H. Position

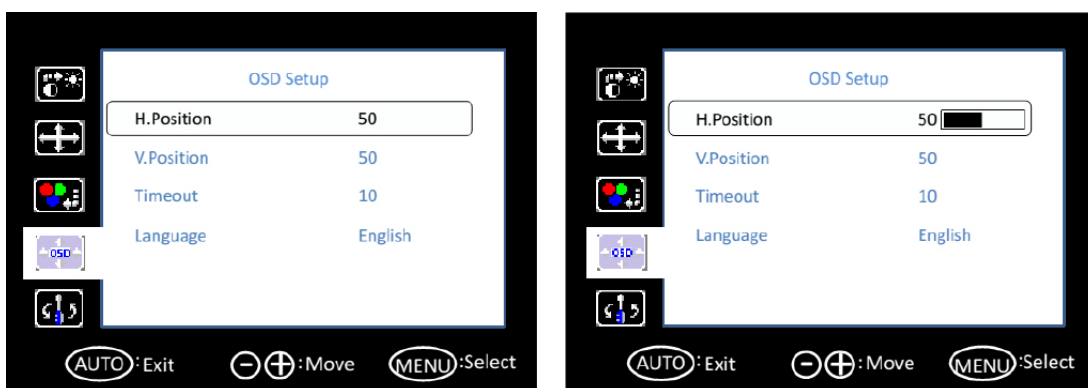

V. Position

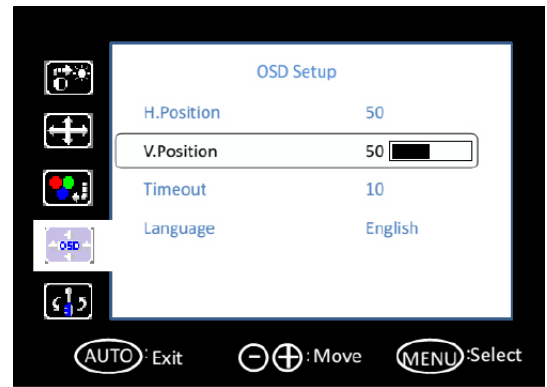
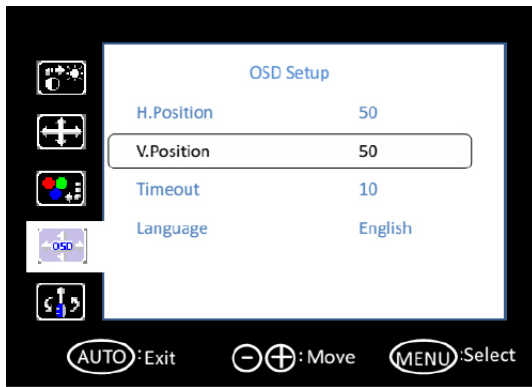

Timeout

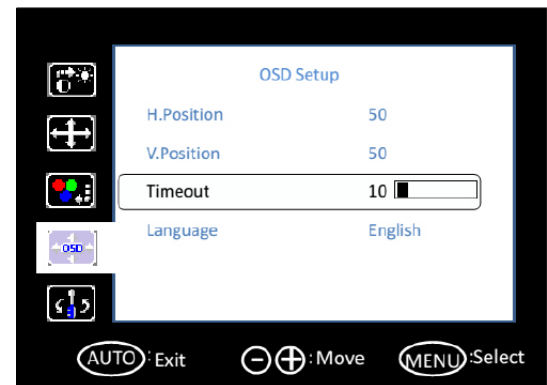
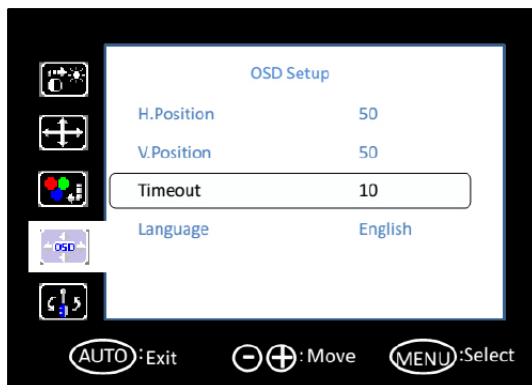

Language

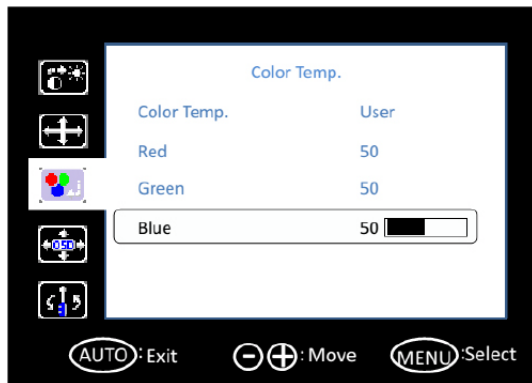

Language ◀ English ▶



语言 ◀ 简体中文 ▶



язык ◀ русский ▶



語言 ◀ 繁體中文 ▶



Langue ◀ français ▶



언어 ◀ 한국어 ▶



Idioma ◀ Español ▶



Idioma ◀ Português ▶



3.3.1.5 Extra Input Select

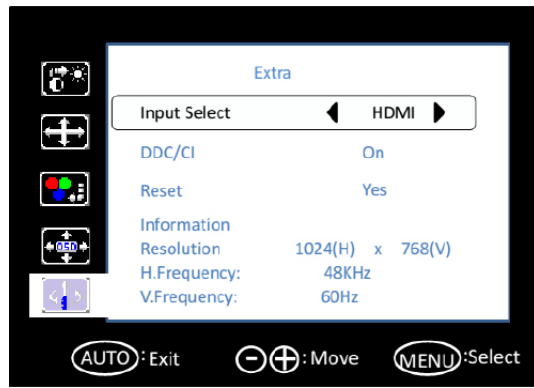
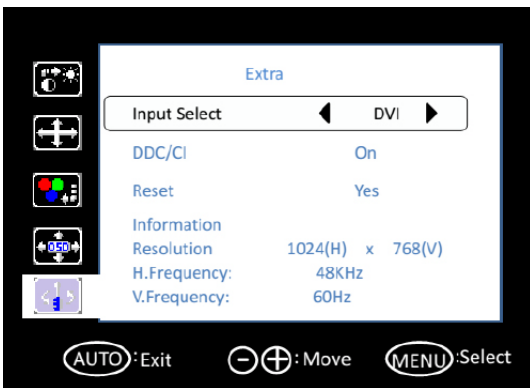
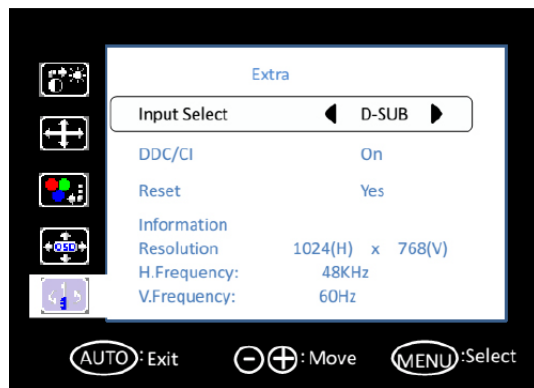
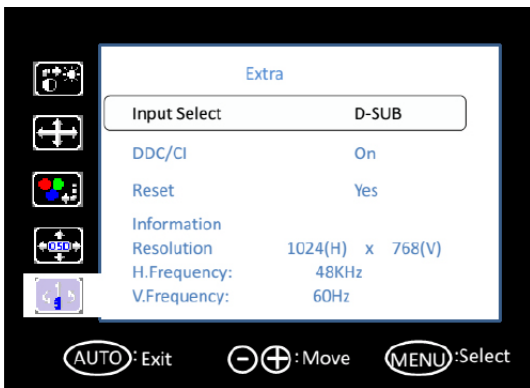

DDC/CI

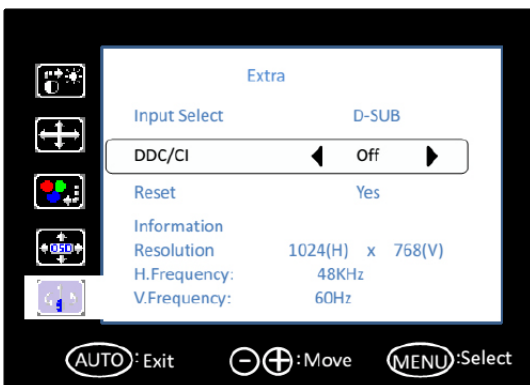
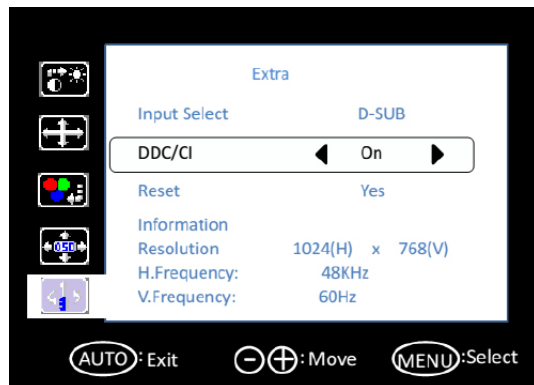
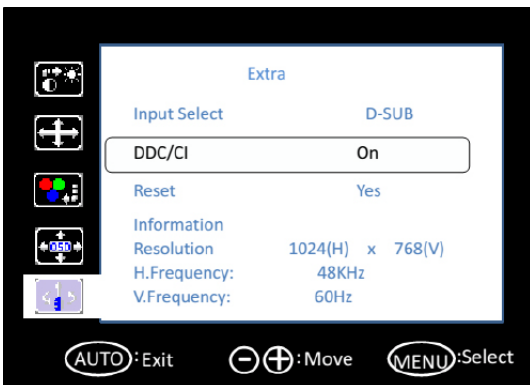

Reset

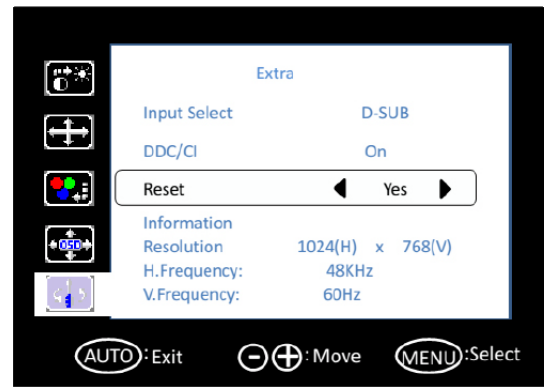
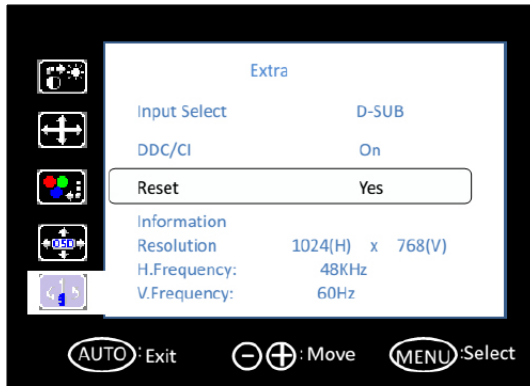

Layer 1	Layer 2	Layer 3	Comment	Default Value
	Contrast	0 100	Adjusts contrast	50
	Brightness	0 100	Adjusts brightness (backlight)	90
Luminance	ECO Mode	Standard		
		Sport		
		Movie		
		Game		Standard
		Internet		
	DCR	On Off	Sets dynamic contrast ratio	Off
Image Setup	Clock	0 100	Adjusts clock latency of output capture window	Depends on the input resolution
	Phase	0 100	Adjusts clock phase of output capture window	Depends on the input resolution
	H. Position	0 100	Adjusts horizontal position of output capture window	50
	V. Position	0 100	Adjusts vertical position of output capture window	50
	Image Ratio	Wide 4:3	Adjusts aspect ratio to full screen Adjusts aspect ratio to 4:3 screen	Wide
Color Temperature	Color Temp.	Warm -->	Adjusts color temperature to warm	
		Normal -->	Adjusts color temperature to normal	
		Cool -->	Adjusts color temperature to cool	
		User -->	Adjusts color temperature to user defined	User

	H. Position	<u>0</u> <u>100</u>	Adjusts OSD horizontal position	50
	V. Position	<u>0</u> <u>100</u>	Adjusts OSD vertical position	50
	Timeout	<u>5</u> <u>100</u>	Sets OSD timeout counter	10
OSD Setup	Language	English	Sets OSD display language	English
		Spanish		
		French		
		Portuguese		
		Russian		
		简体中文		
		繁體中文		
		Korean		
Extra	Input Select	D-Sub	Sets input source	Depends on the input source
		HDMI		
		DVI		
	DDC/CI	On	Sets DDC/CI function on/off	On
		Off		
Reset	Yes	Sets user setting reset	On	
	No			
Information	Resolution	Display current source information	Depends on the input source	
	H. Frequency			
	V. Frequency			

3.4 Touch Drivers

The touch screen driver is available on line at the Advantech website. Use the following link to access the driver:

<http://support.advantech.com/support/default.aspx>

Appendix **A**

Troubleshooting

A.1 Introduction

If you are experiencing trouble with the monitor, or it fails to operate correctly, please refer to the following instructions before calling the Advantech service center. If unable to correct the faults using the instructions below, then please contact the distributor or the services/repair center.

A.2 Troubleshooting

No Images Appears On Screen

- Check to see that all the I/O and power connectors are installed correctly and connected. (Refer to 1.4, Open Frame Bottom view)
- Make sure that none of the connectors are crooked, broken or loose.
- Make sure that the OSD power on the LED is turned on.
- Make sure that the brightness is not in the minimum.
- Make sure that the screen resolution is set to the correct setting for the type of LCD, and that the setting does not exceed the resolution specified for the particular model of LCD.

The image is incorrectly displayed, or the full screen image does not appear

- Please make sure the screen resolution on the motherboard is correct.

The position of screen is not in the center

- Adjust the H-position and V-position or perform "Auto".

Out of range

- When the message "Out of Range" appears onscreen, it indicates that the signal of the computer is not compatible with the LCD display; i.e. the resolution exceeds the specified resolution for the LCD.
- Adjust the BIOS setting to match the correct resolution.

No signal

- The display is powered on, but can neither receive or display any signal from the computer. Check all power switches, power cables and VGA signal cables to ensure that all are connected correctly on both sides.

Going to sleep

- If the system goes to sleep, then the display has either been set to power-saving mode, or the display is experiencing a sudden signal disconnection problem. Check the BIOS system settings, and/or Windows configuration. Then check the connection of the power cable to computer on both sides.

ADVANTECH

Enabling an Intelligent Planet

www.advantech.com

Please verify specifications before quoting. This guide is intended for reference purposes only.

All product specifications are subject to change without notice.

No part of this publication may be reproduced in any form or by any means, electronic, photocopying, recording or otherwise, without prior written permission of the publisher.

All brand and product names are trademarks or registered trademarks of their respective companies.

© Advantech Co., Ltd. 2019